

# MATLAB<sup>®</sup>

The Language of Technical Computing

Computation

Visualization

Programming

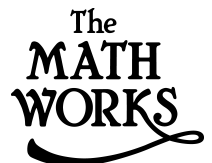

Getting Started with MATLAB

*Version 6*

## How to Contact The MathWorks:



www.mathworks.com  
comp.soft-sys.matlab

Web  
Newsgroup



support@mathworks.com  
suggest@mathworks.com  
bugs@mathworks.com  
doc@mathworks.com  
service@mathworks.com  
info@mathworks.com

Technical support  
Product enhancement suggestions  
Bug reports  
Documentation error reports  
Order status, license renewals, passcodes  
Sales, pricing, and general information



508-647-7000

Phone



508-647-7001

Fax



The MathWorks, Inc.  
3 Apple Hill Drive  
Natick, MA 01760-2098

Mail

For contact information about worldwide offices, see the MathWorks Web site.

### *Getting Started with MATLAB*

© COPYRIGHT 1984 - 2001 by The MathWorks, Inc.

The software described in this document is furnished under a license agreement. The software may be used or copied only under the terms of the license agreement. No part of this manual may be photocopied or reproduced in any form without prior written consent from The MathWorks, Inc.

FEDERAL ACQUISITION: This provision applies to all acquisitions of the Program and Documentation by or for the federal government of the United States. By accepting delivery of the Program, the government hereby agrees that this software qualifies as "commercial" computer software within the meaning of FAR Part 12.212, DFARS Part 227.7202-1, DFARS Part 227.7202-3, DFARS Part 252.227-7013, and DFARS Part 252.227-7014. The terms and conditions of The MathWorks, Inc. Software License Agreement shall pertain to the government's use and disclosure of the Program and Documentation, and shall supersede any conflicting contractual terms or conditions. If this license fails to meet the government's minimum needs or is inconsistent in any respect with federal procurement law, the government agrees to return the Program and Documentation, unused, to MathWorks.

MATLAB, Simulink, Stateflow, Handle Graphics, and Real-Time Workshop are registered trademarks, and Target Language Compiler is a trademark of The MathWorks, Inc.

Other product or brand names are trademarks or registered trademarks of their respective holders.

Printing History:	December 1996	First printing	For MATLAB 5
	May 1997	Second printing	For MATLAB 5.1
	September 1998	Third printing	For MATLAB 5.3
	September 2000	Fourth printing	Revised for MATLAB 6, Release 12
	June 2001	Online only	Minor update for MATLAB 6.1, Release 12.1

## Introduction

1

<b>What Is MATLAB?</b> .....	1-2
The MATLAB System .....	1-3
<b>MATLAB Documentation</b> .....	1-4
MATLAB Online Help .....	1-4

## Development Environment

2

<b>Introduction</b> .....	2-2
<b>Starting and Quitting MATLAB</b> .....	2-3
Starting MATLAB .....	2-3
Quitting MATLAB .....	2-3
<b>MATLAB Desktop</b> .....	2-4
<b>Desktop Tools</b> .....	2-6
Command Window .....	2-6
Launch Pad .....	2-8
Help Browser .....	2-8
Current Directory Browser .....	2-11
Workspace Browser .....	2-12
Editor/Debugger .....	2-14
<b>Other Development Environment Features</b> .....	2-15

<b>Matrices and Magic Squares</b> .....	<b>3-2</b>
Entering Matrices .....	<b>3-3</b>
sum, transpose, and diag .....	<b>3-4</b>
Subscripts .....	<b>3-6</b>
The Colon Operator .....	<b>3-7</b>
The magic Function .....	<b>3-8</b>
<b>Expressions</b> .....	<b>3-10</b>
Variables .....	<b>3-10</b>
Numbers .....	<b>3-10</b>
Operators .....	<b>3-11</b>
Functions .....	<b>3-11</b>
Examples of Expressions .....	<b>3-13</b>
<b>Working with Matrices</b> .....	<b>3-14</b>
Generating Matrices .....	<b>3-14</b>
The load Command .....	<b>3-15</b>
M-Files .....	<b>3-15</b>
Concatenation .....	<b>3-16</b>
Deleting Rows and Columns .....	<b>3-17</b>
<b>More About Matrices and Arrays</b> .....	<b>3-18</b>
Linear Algebra .....	<b>3-18</b>
Arrays .....	<b>3-21</b>
Multivariate Data .....	<b>3-24</b>
Scalar Expansion .....	<b>3-25</b>
Logical Subscripting .....	<b>3-26</b>
The find Function .....	<b>3-27</b>
<b>Controlling Command Window Input and Output</b> .....	<b>3-28</b>
The format Command .....	<b>3-28</b>
Suppressing Output .....	<b>3-30</b>
Entering Long Command Lines .....	<b>3-30</b>
Command Line Editing .....	<b>3-30</b>

<b>Basic Plotting</b> .....	<b>4-2</b>
Creating a Plot .....	<b>4-2</b>
Multiple Data Sets in One Graph .....	<b>4-3</b>
Specifying Line Styles and Colors .....	<b>4-4</b>
Plotting Lines and Markers .....	<b>4-5</b>
Imaginary and Complex Data .....	<b>4-6</b>
Adding Plots to an Existing Graph .....	<b>4-7</b>
Figure Windows .....	<b>4-8</b>
Multiple Plots in One Figure .....	<b>4-9</b>
Controlling the Axes .....	<b>4-10</b>
Axis Labels and Titles .....	<b>4-12</b>
Saving a Figure .....	<b>4-13</b>
<b>Editing Plots</b> .....	<b>4-14</b>
Interactive Plot Editing .....	<b>4-14</b>
Using Functions to Edit Graphs .....	<b>4-14</b>
Using Plot Editing Mode .....	<b>4-15</b>
Using the Property Editor .....	<b>4-16</b>
<b>Mesh and Surface Plots</b> .....	<b>4-18</b>
Visualizing Functions of Two Variables .....	<b>4-18</b>
<b>Images</b> .....	<b>4-22</b>
<b>Printing Graphics</b> .....	<b>4-24</b>
<b>Handle Graphics</b> .....	<b>4-26</b>
Graphics Objects .....	<b>4-26</b>
Setting Object Properties .....	<b>4-28</b>
Finding the Handles of Existing Objects .....	<b>4-31</b>
<b>Graphics User Interfaces</b> .....	<b>4-33</b>
Graphical User Interface Design Tools .....	<b>4-33</b>
<b>Animations</b> .....	<b>4-34</b>
Erase Mode Method .....	<b>4-34</b>
Creating Movies .....	<b>4-35</b>

**Flow Control** ..... 5-2

- if ..... 5-2
- switch and case ..... 5-3
- for ..... 5-4
- while ..... 5-5
- continue ..... 5-5
- break ..... 5-6

**Other Data Structures** ..... 5-7

- Multidimensional Arrays ..... 5-7
- Cell Arrays ..... 5-9
- Characters and Text ..... 5-11
- Structures ..... 5-14

**Scripts and Functions** ..... 5-17

- Scripts ..... 5-17
- Functions ..... 5-18
- Global Variables ..... 5-20
- Passing String Arguments to Functions ..... 5-20
- The eval Function ..... 5-22
- Vectorization ..... 5-22
- Preallocation ..... 5-23
- Function Handles ..... 5-23
- Function Functions ..... 5-24

**Demonstration Programs Included with MATLAB** ..... 5-27

# Introduction

---

<b>What Is MATLAB?</b> . . . . .	1-2
The MATLAB System . . . . .	1-3
<b>MATLAB Documentation</b> . . . . .	1-4
MATLAB Online Help . . . . .	1-4

## What Is MATLAB?

MATLAB<sup>®</sup> is a high-performance language for technical computing. It integrates computation, visualization, and programming in an easy-to-use environment where problems and solutions are expressed in familiar mathematical notation. Typical uses include:

- Math and computation
- Algorithm development
- Modeling, simulation, and prototyping
- Data analysis, exploration, and visualization
- Scientific and engineering graphics
- Application development, including graphical user interface building

MATLAB is an interactive system whose basic data element is an array that does not require dimensioning. This allows you to solve many technical computing problems, especially those with matrix and vector formulations, in a fraction of the time it would take to write a program in a scalar noninteractive language such as C or Fortran.

The name MATLAB stands for *matrix laboratory*. MATLAB was originally written to provide easy access to matrix software developed by the LINPACK and EISPACK projects. Today, MATLAB uses software developed by the LAPACK and ARPACK projects, which together represent the state-of-the-art in software for matrix computation.

MATLAB has evolved over a period of years with input from many users. In university environments, it is the standard instructional tool for introductory and advanced courses in mathematics, engineering, and science. In industry, MATLAB is the tool of choice for high-productivity research, development, and analysis.

MATLAB features a family of application-specific solutions called *toolboxes*. Very important to most users of MATLAB, toolboxes allow you to *learn* and *apply* specialized technology. Toolboxes are comprehensive collections of MATLAB functions (M-files) that extend the MATLAB environment to solve particular classes of problems. Areas in which toolboxes are available include signal processing, control systems, neural networks, fuzzy logic, wavelets, simulation, and many others.



## The MATLAB System

The MATLAB system consists of five main parts:

**Development Environment.** This is the set of tools and facilities that help you use MATLAB functions and files. Many of these tools are graphical user interfaces. It includes the MATLAB desktop and Command Window, a command history, and browsers for viewing help, the workspace, files, and the search path.

**The MATLAB Mathematical Function Library.** This is a vast collection of computational algorithms ranging from elementary functions like sum, sine, cosine, and complex arithmetic, to more sophisticated functions like matrix inverse, matrix eigenvalues, Bessel functions, and fast Fourier transforms.

**The MATLAB Language.** This is a high-level matrix/array language with control flow statements, functions, data structures, input/output, and object-oriented programming features. It allows both “programming in the small” to rapidly create quick and dirty throw-away programs, and “programming in the large” to create complete large and complex application programs.

**Handle Graphics®.** This is the MATLAB graphics system. It includes high-level commands for two-dimensional and three-dimensional data visualization, image processing, animation, and presentation graphics. It also includes low-level commands that allow you to fully customize the appearance of graphics as well as to build complete graphical user interfaces on your MATLAB applications.

**The MATLAB Application Program Interface (API).** This is a library that allows you to write C and Fortran programs that interact with MATLAB. It includes facilities for calling routines from MATLAB (dynamic linking), calling MATLAB as a computational engine, and for reading and writing MAT-files.

## MATLAB Documentation

MATLAB provides extensive documentation, in both printed and online format, to help you learn about and use all of its features. If you are a new user, start with this book, *Getting Started with MATLAB*, which introduces you to MATLAB. It covers all the primary MATLAB features at a high level, including plenty of examples to help you to learn the material quickly.

- Chapter 2, “Development Environment” – introduces the MATLAB development environment, including information about tools and the MATLAB desktop.
- Chapter 3, “Manipulating Matrices” – introduces how to use MATLAB to generate matrices and perform mathematical operations on matrices.
- Chapter 4, “Graphics” – introduces MATLAB graphic capabilities, including information about plotting data, annotating graphs, and working with images.
- Chapter 5, “Programming with MATLAB” – describes how to use the MATLAB language to create scripts and functions, and manipulate data structures, such as cell arrays and multidimensional arrays. This section also provides an overview of the demo programs included with MATLAB.

To find more detailed information about any of these topics, use the MATLAB online documentation. The online Help provides task-oriented and reference information about MATLAB features. The MATLAB documentation is also available in printed form and in PDF format.

### MATLAB Online Help

To view the online documentation, select the **Help** option on the MATLAB menu bar. (For more information about using the online documentation, see “Help Browser” on page 2-8.)

Under “Using MATLAB,” the documentation is organized into these main topics:

- “Development Environment” – provides complete information on the MATLAB desktop.
- “Mathematics” – describes how to use MATLAB’s mathematical and statistical capabilities.

- “Programming and Data Types” – describes how to create scripts and functions using the MATLAB language.
- “Graphics” – describes how to plot your data using MATLAB’s graphics capabilities.
- “3-D Visualization” – introduces how to use views, lighting, and transparency to achieve more complex graphic effects than can be achieved using the basic plotting functions.
- “External Interfaces/API” – describes MATLAB’s interfaces to C and Fortran programs, Java classes and objects, data files, serial port I/O, ActiveX, and DDE.
- “Creating Graphical User Interfaces” – describes how to use MATLAB’s graphical user interface layout tools.

Under “Reference,” the online documentation is organized into these main topics:

- “MATLAB Function Reference” – covers all of the core MATLAB functions, providing information on function syntax, description, mathematical algorithm (where appropriate), and related functions.  
You can easily locate any function using either the “Function By Category” or “Alphabetical List of Functions” option.
- “External Interfaces/API Reference” – covers those functions used by the MATLAB external interfaces, providing information on syntax in the calling language, description, arguments, return values, and examples.

MATLAB online documentation also includes the “Graphics Object Property Browser,” which enables you to easily access descriptions of graphics object properties. For more information about MATLAB graphics, see “Handle Graphics” on page 4-26.



# Development Environment

---

<b>Introduction</b> . . . . .	2-2
<b>Starting and Quitting MATLAB</b> . . . . .	2-3
<b>MATLAB Desktop</b> . . . . .	2-4
<b>Desktop Tools</b> . . . . .	2-6
<b>Other Development Environment Features</b> . . . . .	2-15

### Introduction

This chapter provides a brief introduction to starting and quitting MATLAB, and the tools and functions that help you to work with MATLAB variables and files. For more information about the topics covered here, see the corresponding topics under “Development Environment” in the MATLAB documentation, which is available online as well as in print.

## Starting and Quitting MATLAB

### Starting MATLAB

On a Microsoft Windows platform, to start MATLAB, double-click the MATLAB shortcut icon  on your Windows desktop.

On a UNIX platform, to start MATLAB, type `matlab` at the operating system prompt.

After starting MATLAB, the MATLAB desktop opens – see “MATLAB Desktop” on page 2-4.

You can change the directory in which MATLAB starts, define startup options including running a script upon startup, and reduce startup time in some situations.

### Quitting MATLAB

To end your MATLAB session, select **Exit MATLAB** from the **File** menu in the desktop, or type `quit` in the Command Window. To execute specified functions each time MATLAB quits, such as saving the workspace, you can create and run a `finish.m` script.

## MATLAB Desktop

When you start MATLAB, the MATLAB desktop appears, containing tools (graphical user interfaces) for managing files, variables, and applications associated with MATLAB.

The first time MATLAB starts, the desktop appears as shown in the following illustration, although your Launch Pad may contain different entries.

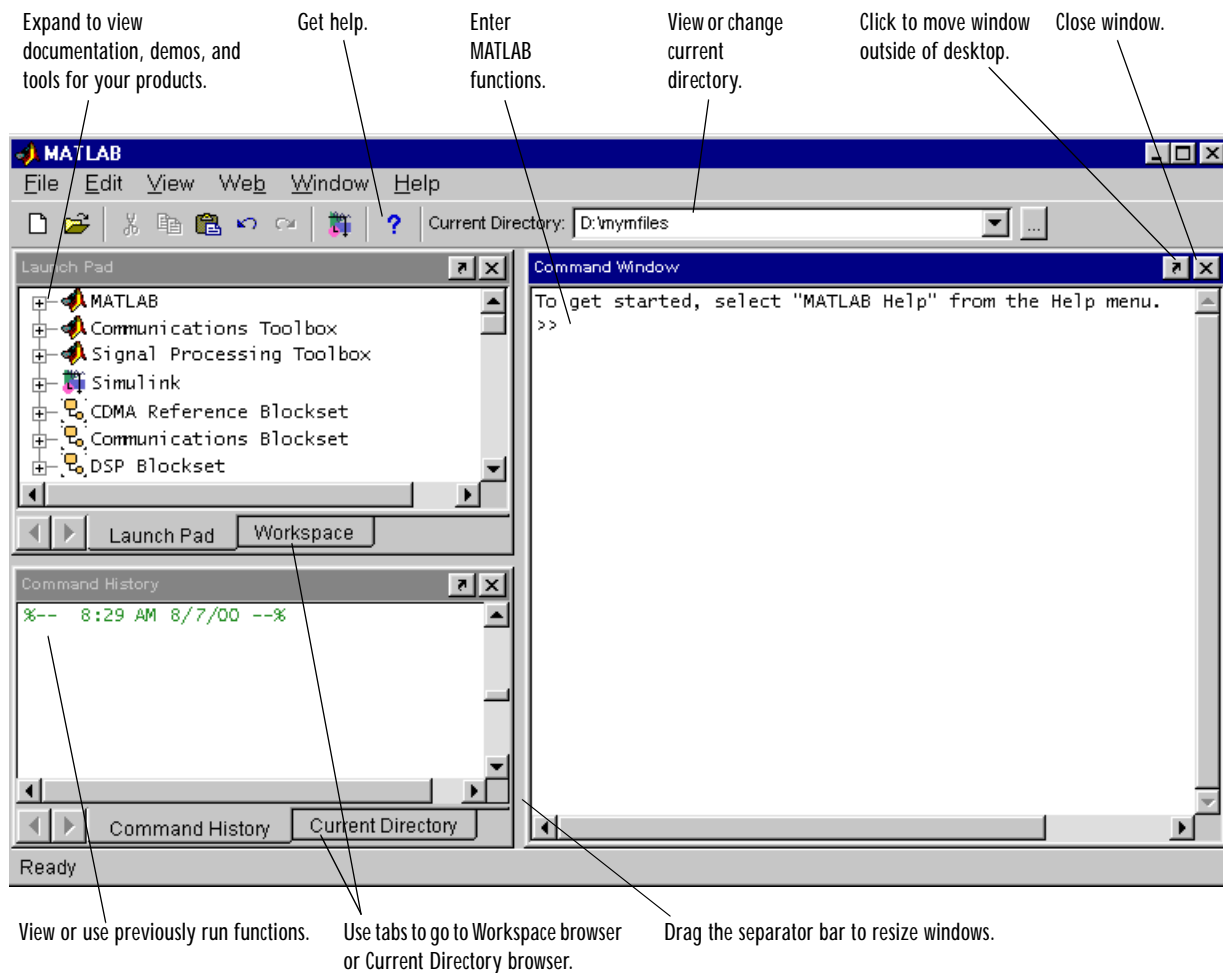



You can change the way your desktop looks by opening, closing, moving, and resizing the tools in it. You can also move tools outside of the desktop or return them back inside the desktop (docking). All the desktop tools provide common features such as context menus and keyboard shortcuts.

You can specify certain characteristics for the desktop tools by selecting **Preferences** from the **File** menu. For example, you can specify the font characteristics for Command Window text. For more information, click the **Help** button in the **Preferences** dialog box.

## Desktop Tools

This section provides an introduction to MATLAB's desktop tools. You can also use MATLAB functions to perform most of the features found in the desktop tools. The tools are:

- “Command Window”
- “Command History”
- “Launch Pad”
- “Help Browser”
- “Current Directory Browser”
- “Workspace Browser”
- “Array Editor”
- “Editor/Debugger”

### Command Window

Use the **Command Window** to enter variables and run functions and M-files. For more information on controlling input and output, see “Controlling Command Window Input and Output” on page 3-28.

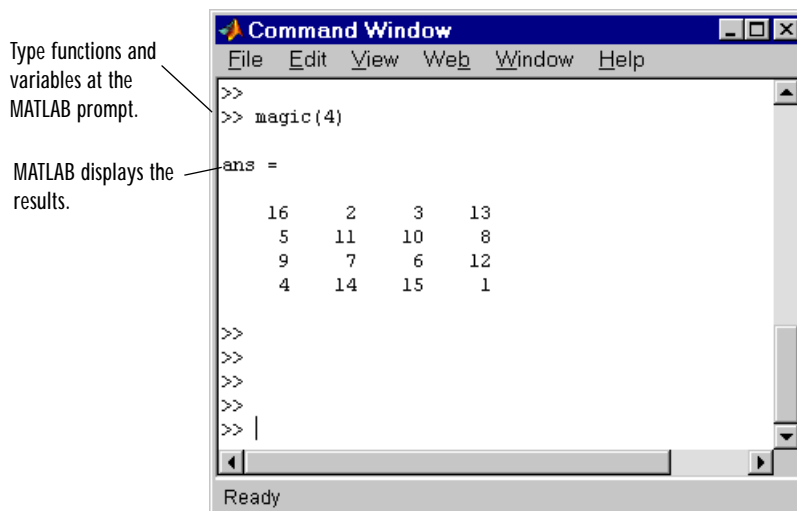

## Command History

Lines you enter in the Command Window are logged in the **Command History** window. In the Command History, you can view previously used functions, and copy and execute selected lines.

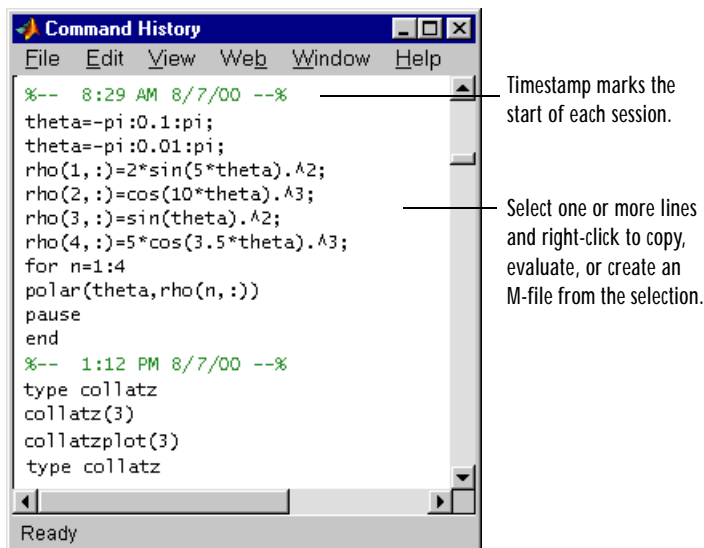

To save the input and output from a MATLAB session to a file, use the `diary` function.

## Running External Programs

You can run external programs from the MATLAB Command Window. The exclamation point character `!` is a shell escape and indicates that the rest of the input line is a command to the operating system. This is useful for invoking utilities or running other programs without quitting MATLAB. On Linux, for example,

```
!emacs magik.m
```

invokes an editor called `emacs` for a file named `magik.m`. When you quit the external program, the operating system returns control to MATLAB.

## Launch Pad

MATLAB's **Launch Pad** provides easy access to tools, demos, and documentation.

Sample of listings in Launch Pad – you'll see listings for all products installed on your system.

Help - double-click to go directly to documentation for the product.

Demos - double-click to display the demo launcher for the product.

Tools - double-click to open the tool.

Click + to show the listing for a product.

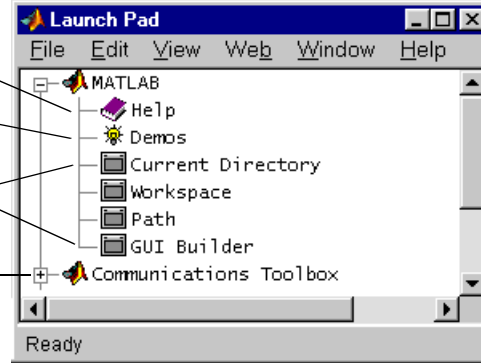

## Help Browser

Use the Help browser to search and view documentation for all your MathWorks products. The Help browser is a Web browser integrated into the MATLAB desktop that displays HTML documents.

To open the Help browser, click the help button  in the toolbar, or type helpbrowser in the Command Window.

Tabs in the Help Navigator pane provide different ways to find documentation. View documentation in the display pane.

Use the close box to hide the pane.

Drag the separator bar to adjust the width of the panes.

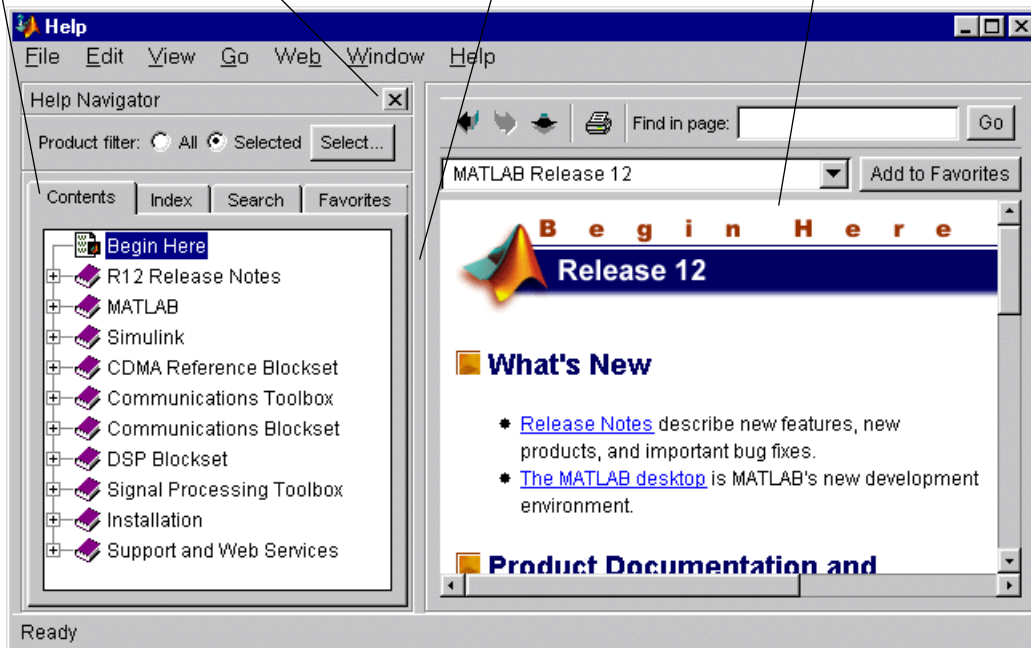

The Help browser consists of two panes, the Help Navigator, which you use to find information, and the display pane, where you view the information.

### Help Navigator

Use the Help Navigator to find information. It includes:

- **Product filter** – Set the filter to show documentation only for the products you specify.
- **Contents** tab – View the titles and tables of contents of documentation for your products.
- **Index** tab – Find specific index entries (selected keywords) in the MathWorks documentation for your products.
- **Search** tab – Look for a specific phrase in the documentation. To get help for a specific function, set the **Search type** to **Function Name**.
- **Favorites** tab – View a list of documents you previously designated as favorites.

### Display Pane

After finding documentation using the Help Navigator, view it in the display pane. While viewing the documentation, you can:

- Browse to other pages – Use the arrows at the tops and bottoms of the pages, or use the back and forward buttons in the toolbar.
- Bookmark pages – Click the **Add to Favorites** button in the toolbar.
- Print pages – Click the print button in the toolbar.
- Find a term in the page – Type a term in the **Find in page** field in the toolbar and click **Go**.

Other features available in the display pane are: copying information, evaluating a selection, and viewing Web pages.

### For More Help

In addition to the Help browser, you can use help functions. To get help for a specific function, use `doc`. For example, `doc format` displays help for the `format` function in the Help browser. Other means for getting help include contacting Technical Support (<http://www.mathworks.com/support>) and participating in the newsgroup for MATLAB users, `comp.soft-sys.matlab`.

## Current Directory Browser

MATLAB file operations use the current directory and the search path as reference points. Any file you want to run must either be in the current directory or on the search path.

A quick way to view or change the current directory is by using the **Current Directory** field in the desktop toolbar as shown below.

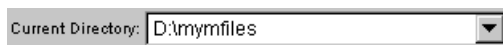

To search for, view, open, and make changes to MATLAB-related directories and files, use the MATLAB Current Directory browser. Alternatively, you can use the functions `dir`, `cd`, and `delete`.

Use the pathname edit box to view directories and their contents

Click the find button to search for content within M-files

Double-click a file to open it in an appropriate tool.

View the help portion of the selected M-file.

All files	File Type	Last Modified	Description
results	Folder	23-Jun-2000 4:55 PM	
bucky.m	M-file	27-Nov-1997 6:28 AM	BUCKY Con
caution.mdl	Model	13-Nov-1997 2:43 PM	
collatz.m	M-file	21-Jun-2000 1:21 PM	Collatz pro
collatzall.m	M-file	15-Jun-2000 4:51 PM	Plot lengtl
collatzplot.m	M-file	15-Jun-2000 4:42 PM	Plot lengtl
diary		20-Dec-1999 3:19 PM	
falling.m	M-file	10-Dec-1999 4:24 PM	
finish.m	M-file	06-Mar-2000 3:04 PM	FINISHDLG
knots.mat	MAT-file	19-Apr-2000 4:48 PM	

B = BUCKY is the 60-by-60 sparse adjacency matrix of the connectivity graph of the geodesic dome, the soccer ball, and the carbon-60 molecule.

## Search Path

To determine how to execute functions you call, MATLAB uses a *search path* to find M-files and other MATLAB-related files, which are organized in directories on your file system. Any file you want to run in MATLAB must reside in the current directory or in a directory that is on the search path. By default, the files supplied with MATLAB and MathWorks toolboxes are included in the search path.

To see which directories are on the search path or to change the search path, select **Set Path** from the **File** menu in the desktop, and use the **Set Path** dialog box. Alternatively, you can use the path function to view the search path, addpath to add directories to the path, and rmpath to remove directories from the path.

## Workspace Browser

The MATLAB workspace consists of the set of variables (named arrays) built up during a MATLAB session and stored in memory. You add variables to the workspace by using functions, running M-files, and loading saved workspaces.

To view the workspace and information about each variable, use the Workspace browser, or use the functions who and whos.

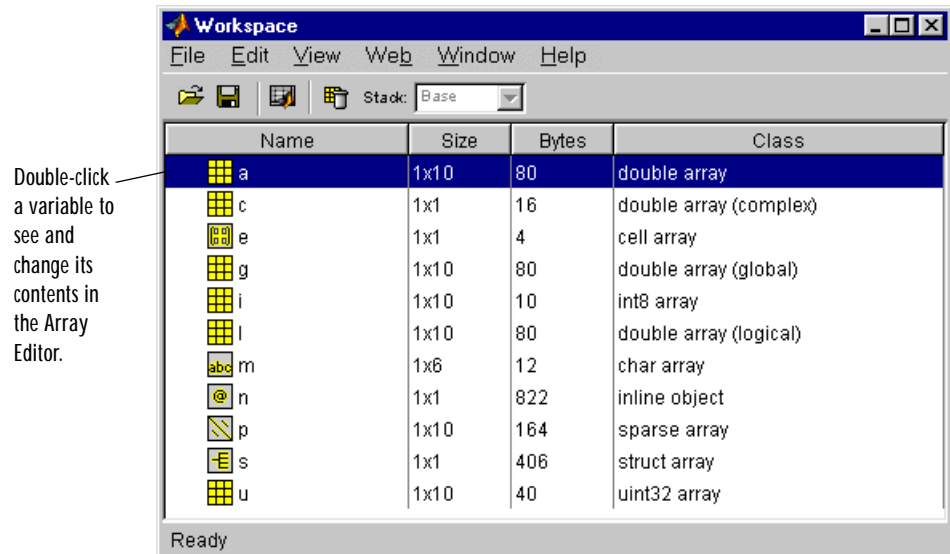



To delete variables from the workspace, select the variable and select **Delete** from the **Edit** menu. Alternatively, use the `clear` function.

The workspace is not maintained after you end the MATLAB session. To save the workspace to a file that can be read during a later MATLAB session, select **Save Workspace As** from the **File** menu, or use the `save` function. This saves the workspace to a binary file called a MAT-file, which has a `.mat` extension. There are options for saving to different formats. To read in a MAT-file, select **Import Data** from the **File** menu, or use the `load` function.

### Array Editor

Double-click on a variable in the Workspace browser to see it in the Array Editor. Use the Array Editor to view and edit a visual representation of one- or two-dimensional numeric arrays, strings, and cell arrays of strings that are in the workspace.

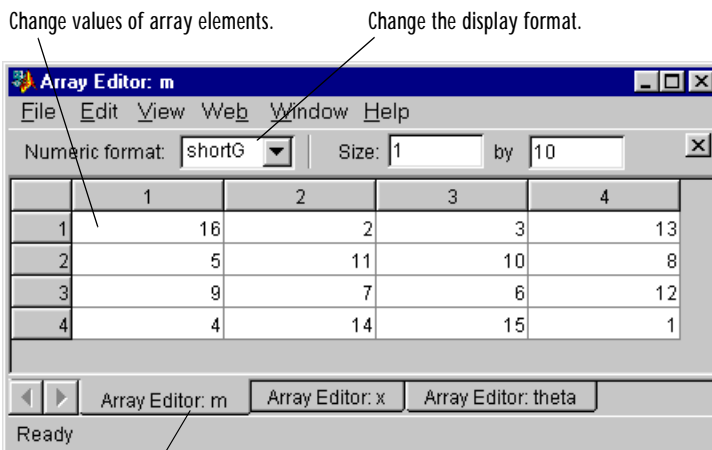

Use the tabs to view the variables you have open in the Array Editor.

## Editor/Debugger

Use the Editor/Debugger to create and debug M-files, which are programs you write to run MATLAB functions. The Editor/Debugger provides a graphical user interface for basic text editing, as well as for M-file debugging.

Comment selected lines and specify indenting style using the Text menu. Find and replace strings.

Set breakpoints where you want execution to pause so you can examine variables.

Hold the cursor over a variable and its current value appears (known as a datatip).

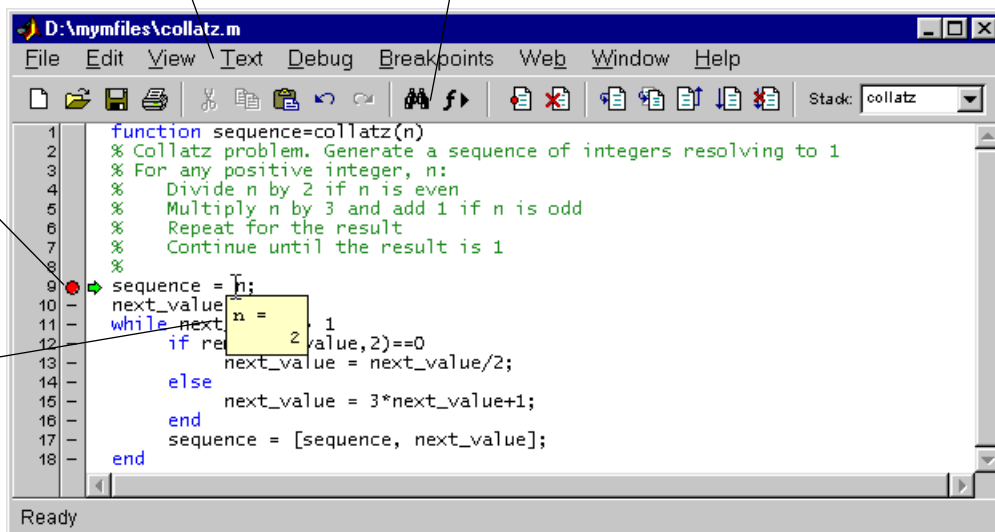

You can use any text editor to create M-files, such as Emacs, and can use preferences (accessible from the desktop **File** menu) to specify that editor as the default. If you use another editor, you can still use the MATLAB Editor/Debugger for debugging, or you can use debugging functions, such as `dbstop`, which sets a breakpoint.

If you just need to view the contents of an M-file, you can display it in the Command Window by using the `type` function.

## Other Development Environment Features

Additional development environment features are:

- **Importing and Exporting Data** – Techniques for bringing data created by other applications into the MATLAB workspace, including the Import Wizard, and packaging MATLAB workspace variables for use by other applications.
- **Improving M-File Performance** – The Profiler is a tool that measures where an M-file is spending its time. Use it to help you make speed improvements.
- **Interfacing with Source Control Systems** – Access your source control system from within MATLAB, Simulink<sup>®</sup>, and Stateflow<sup>®</sup>.
- **Using Notebook** – Access MATLAB's numeric computation and visualization software from within a word processing environment (Microsoft Word).



# Manipulating Matrices

---

<b>Matrices and Magic Squares . . . . .</b>	<b>3-2</b>
<b>Expressions . . . . .</b>	<b>3-10</b>
<b>Working with Matrices . . . . .</b>	<b>3-14</b>
<b>More About Matrices and Arrays . . . . .</b>	<b>3-18</b>
<b>Controlling Command Window Input and Output . . .</b>	<b>3-28</b>

## Matrices and Magic Squares

In MATLAB, a matrix is a rectangular array of numbers. Special meaning is sometimes attached to 1-by-1 matrices, which are scalars, and to matrices with only one row or column, which are vectors. MATLAB has other ways of storing both numeric and nonnumeric data, but in the beginning, it is usually best to think of everything as a matrix. The operations in MATLAB are designed to be as natural as possible. Where other programming languages work with numbers one at a time, MATLAB allows you to work with entire matrices quickly and easily. A good example matrix, used throughout this book, appears in the Renaissance engraving *Melancholia I* by the German artist and amateur mathematician Albrecht Dürer.



This image is filled with mathematical symbolism, and if you look carefully, you will see a matrix in the upper right corner. This matrix is known as a magic square and was believed by many in Dürer's time to have genuinely magical properties. It does turn out to have some fascinating characteristics worth exploring.

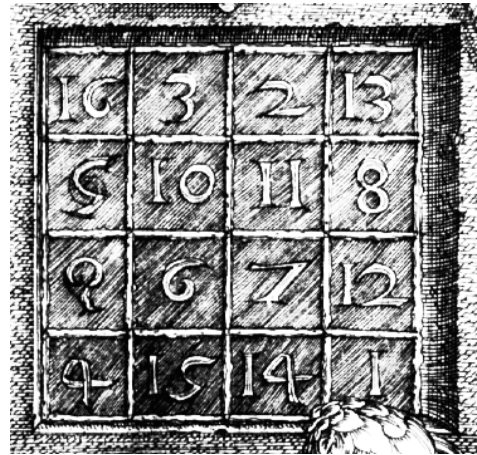

## Entering Matrices

The best way for you to get started with MATLAB is to learn how to handle matrices. Start MATLAB and follow along with each example.

You can enter matrices into MATLAB in several different ways:

- Enter an explicit list of elements.
- Load matrices from external data files.
- Generate matrices using built-in functions.
- Create matrices with your own functions in M-files.

Start by entering Dürer's matrix as a list of its elements. You have only to follow a few basic conventions:

- Separate the elements of a row with blanks or commas.
- Use a semicolon, `;`, to indicate the end of each row.
- Surround the entire list of elements with square brackets, `[ ]`.

To enter Dürer's matrix, simply type in the Command Window

```
A = [16 3 2 13; 5 10 11 8; 9 6 7 12; 4 15 14 1]
```

MATLAB displays the matrix you just entered.

```
A =  
    16     3     2    13  
     5    10    11     8  
     9     6     7    12  
     4    15    14     1
```

This exactly matches the numbers in the engraving. Once you have entered the matrix, it is automatically remembered in the MATLAB workspace. You can refer to it simply as *A*. Now that you have *A* in the workspace, take a look at what makes it so interesting. Why is it magic?

### sum, transpose, and diag

You're probably already aware that the special properties of a magic square have to do with the various ways of summing its elements. If you take the sum along any row or column, or along either of the two main diagonals, you will always get the same number. Let's verify that using MATLAB. The first statement to try is

```
sum(A)
```

MATLAB replies with

```
ans =  
    34    34    34    34
```

When you don't specify an output variable, MATLAB uses the variable *ans*, short for *answer*, to store the results of a calculation. You have computed a row vector containing the sums of the columns of *A*. Sure enough, each of the columns has the same sum, the *magic* sum, 34.

How about the row sums? MATLAB has a preference for working with the columns of a matrix, so the easiest way to get the row sums is to transpose the matrix, compute the column sums of the transpose, and then transpose the result. The transpose operation is denoted by an apostrophe or single quote, `'`. It flips a matrix about its main diagonal and it turns a row vector into a column vector. So

```
A'  
produces
```



```
ans =
    16     5     9     4
     3    10     6    15
     2    11     7    14
    13     8    12     1
```

And

```
sum(A')'
```

produces a column vector containing the row sums

```
ans =
    34
    34
    34
    34
```

The sum of the elements on the main diagonal is easily obtained with the help of the `diag` function, which picks off that diagonal.

```
diag(A)
```

produces

```
ans =
    16
    10
     7
     1
```

and

```
sum(diag(A))
```

produces

```
ans =
    34
```

The other diagonal, the so-called *antidiagonal*, is not so important mathematically, so MATLAB does not have a ready-made function for it. But a function originally intended for use in graphics, `fliplr`, flips a matrix from left to right.

```
sum(diag(fliplr(A)))
```

```
ans =  
    34
```

You have verified that the matrix in Dürer's engraving is indeed a magic square and, in the process, have sampled a few MATLAB matrix operations. The following sections continue to use this matrix to illustrate additional MATLAB capabilities.

## Subscripts

The element in row  $i$  and column  $j$  of  $A$  is denoted by  $A(i, j)$ . For example,  $A(4, 2)$  is the number in the fourth row and second column. For our magic square,  $A(4, 2)$  is 15. So it is possible to compute the sum of the elements in the fourth column of  $A$  by typing

```
A(1,4) + A(2,4) + A(3,4) + A(4,4)
```

This produces

```
ans =  
    34
```

but is not the most elegant way of summing a single column.

It is also possible to refer to the elements of a matrix with a single subscript,  $A(k)$ . This is the usual way of referencing row and column vectors. But it can also apply to a fully two-dimensional matrix, in which case the array is regarded as one long column vector formed from the columns of the original matrix. So, for our magic square,  $A(8)$  is another way of referring to the value 15 stored in  $A(4, 2)$ .

If you try to use the value of an element outside of the matrix, it is an error.

```
t = A(4,5)  
Index exceeds matrix dimensions.
```

On the other hand, if you store a value in an element outside of the matrix, the size increases to accommodate the newcomer.

```
X = A;  
X(4,5) = 17
```

```
X =
    16     3     2    13     0
     5    10    11     8     0
     9     6     7    12     0
     4    15    14     1    17
```

## The Colon Operator

The colon, `:`, is one of MATLAB's most important operators. It occurs in several different forms. The expression

```
1:10
```

is a row vector containing the integers from 1 to 10

```
1     2     3     4     5     6     7     8     9    10
```

To obtain nonunit spacing, specify an increment. For example,

```
100:-7:50
```

is

```
100    93    86    79    72    65    58    51
```

and

```
0:pi/4:pi
```

is

```
0    0.7854    1.5708    2.3562    3.1416
```

Subscript expressions involving colons refer to portions of a matrix.

```
A(1:k,j)
```

is the first  $k$  elements of the  $j$ th column of  $A$ . So

```
sum(A(1:4,4))
```

computes the sum of the fourth column. But there is a better way. The colon by itself refers to *all* the elements in a row or column of a matrix and the keyword `end` refers to the *last* row or column. So

```
sum(A(:,end))
```

computes the sum of the elements in the last column of A.

```
ans =  
    34
```

Why is the magic sum for a 4-by-4 square equal to 34? If the integers from 1 to 16 are sorted into four groups with equal sums, that sum must be

```
sum(1:16)/4
```

which, of course, is

```
ans =  
    34
```

## The magic Function

MATLAB actually has a built-in function that creates magic squares of almost any size. Not surprisingly, this function is named `magic`.

```
B = magic(4)  
  
B =  
    16     2     3    13  
     5    11    10     8  
     9     7     6    12  
     4    14    15     1
```

This matrix is almost the same as the one in the Dürer engraving and has all the same “magic” properties; the only difference is that the two middle columns are exchanged. To make this B into Dürer’s A, swap the two middle columns.

```
A = B(:, [1 3 2 4])
```

This says “for each of the rows of matrix B, reorder the elements in the order 1, 3, 2, 4.” It produces

```
A =  
    16     3     2    13  
     5    10    11     8  
     9     6     7    12  
     4    15    14     1
```

**Why would Dürer go to the trouble of rearranging the columns when he could have used MATLAB's ordering? No doubt he wanted to include the date of the engraving, 1514, at the bottom of his magic square.**

## Expressions

Like most other programming languages, MATLAB provides mathematical *expressions*, but unlike most programming languages, these expressions involve entire matrices. The building blocks of expressions are:

- Variables
- Numbers
- Operators
- Functions

### Variables

MATLAB does not require any type declarations or dimension statements. When MATLAB encounters a new variable name, it automatically creates the variable and allocates the appropriate amount of storage. If the variable already exists, MATLAB changes its contents and, if necessary, allocates new storage. For example,

```
num_students = 25
```

creates a 1-by-1 matrix named `num_students` and stores the value 25 in its single element.

Variable names consist of a letter, followed by any number of letters, digits, or underscores. MATLAB uses only the first 31 characters of a variable name. MATLAB is case sensitive; it distinguishes between uppercase and lowercase letters. `A` and `a` are *not* the same variable. To view the matrix assigned to any variable, simply enter the variable name.

### Numbers

MATLAB uses conventional decimal notation, with an optional decimal point and leading plus or minus sign, for numbers. *Scientific notation* uses the letter `e` to specify a power-of-ten scale factor. *Imaginary numbers* use either `i` or `j` as a suffix. Some examples of legal numbers are

```
3          -99          0.0001
9.6397238  1.60210e-20    6.02252e23
1i         -3.14159j     3e5i
```

All numbers are stored internally using the *long* format specified by the IEEE floating-point standard. Floating-point numbers have a finite *precision* of roughly 16 significant decimal digits and a finite *range* of roughly  $10^{-308}$  to  $10^{+308}$ .

## Operators

Expressions use familiar arithmetic operators and precedence rules.

+	Addition
-	Subtraction
*	Multiplication
/	Division
\	Left division (described in “Matrices and Linear Algebra” in <i>Using MATLAB</i> )
^	Power
'	Complex conjugate transpose
( )	Specify evaluation order

## Functions

MATLAB provides a large number of standard elementary mathematical functions, including `abs`, `sqrt`, `exp`, and `sin`. Taking the square root or logarithm of a negative number is not an error; the appropriate complex result is produced automatically. MATLAB also provides many more advanced mathematical functions, including Bessel and gamma functions. Most of these functions accept complex arguments. For a list of the elementary mathematical functions, type

```
help elfun
```

For a list of more advanced mathematical and matrix functions, type

```
help specfun  
help elmat
```

Some of the functions, like `sqrt` and `sin`, are *built-in*. They are part of the MATLAB core so they are very efficient, but the computational details are not readily accessible. Other functions, like `gamma` and `sinh`, are implemented in M-files. You can see the code and even modify it if you want.

Several special functions provide values of useful constants.

<code>pi</code>	3.14159265...
<code>i</code>	Imaginary unit, $\sqrt{-1}$
<code>j</code>	Same as <code>i</code>
<code>eps</code>	Floating-point relative precision, $2^{-52}$
<code>realmin</code>	Smallest floating-point number, $2^{-1022}$
<code>realmax</code>	Largest floating-point number, $(2-\epsilon)2^{1023}$
<code>Inf</code>	Infinity
<code>NaN</code>	Not-a-number

Infinity is generated by dividing a nonzero value by zero, or by evaluating well defined mathematical expressions that *overflow*, i.e., exceed `realmax`.

Not-a-number is generated by trying to evaluate expressions like `0/0` or `Inf-Inf` that do not have well defined mathematical values.

The function names are not reserved. It is possible to overwrite any of them with a new variable, such as

```
eps = 1.e-6
```

and then use that value in subsequent calculations. The original function can be restored with

```
clear eps
```



## Examples of Expressions

You have already seen several examples of MATLAB expressions. Here are a few more examples, and the resulting values.

```
rho = (1+sqrt(5))/2
rho =
    1.6180
```

```
a = abs(3+4i)
a =
    5
```

```
z = sqrt(besselk(4/3,rho-i))
z =
    0.3730+ 0.3214i
```

```
huge = exp(log(realmax))
huge =
    1.7977e+308
```

```
toobig = pi*huge
toobig =
    Inf
```

## Working with Matrices

This section introduces you to other ways of creating matrices.

### Generating Matrices

MATLAB provides four functions that generate basic matrices.

<code>zeros</code>	All zeros
<code>ones</code>	All ones
<code>rand</code>	Uniformly distributed random elements
<code>randn</code>	Normally distributed random elements

Here are some examples.

```
Z = zeros(2,4)
```

```
Z =  
    0    0    0    0  
    0    0    0    0
```

```
F = 5*ones(3,3)
```

```
F =  
    5    5    5  
    5    5    5  
    5    5    5
```

```
N = fix(10*rand(1,10))
```

```
N =  
    4    9    4    4    8    5    2    6    8    0
```

```
R = randn(4,4)
```

```
R =  
    1.0668    0.2944   -0.6918   -1.4410  
    0.0593   -1.3362    0.8580    0.5711  
   -0.0956    0.7143    1.2540   -0.3999  
   -0.8323    1.6236   -1.5937    0.6900
```

## The load Command

The `load` command reads binary files containing matrices generated by earlier MATLAB sessions, or reads text files containing numeric data. The text file should be organized as a rectangular table of numbers, separated by blanks, with one row per line, and an equal number of elements in each row. For example, outside of MATLAB, create a text file containing these four lines.

```
16.0    3.0    2.0    13.0
 5.0   10.0   11.0    8.0
 9.0    6.0    7.0   12.0
 4.0   15.0   14.0    1.0
```

Store the file under the name `magik.dat`. Then the command

```
load magik.dat
```

reads the file and creates a variable, `magik`, containing our example matrix.

An easy way to read data into MATLAB in many text or binary formats is to use Import Wizard.

## M-Files

You can create your own matrices using *M-files*, which are text files containing MATLAB code. Use the MATLAB Editor or another text editor to create a file containing the same statements you would type at the MATLAB command line. Save the file under a name that ends in `.m`.

For example, create a file containing these five lines.

```
A = [ ...
16.0    3.0    2.0    13.0
 5.0   10.0   11.0    8.0
 9.0    6.0    7.0   12.0
 4.0   15.0   14.0    1.0 ];
```

Store the file under the name `magik.m`. Then the statement

```
magik
```

reads the file and creates a variable, `A`, containing our example matrix.

## Concatenation

*Concatenation* is the process of joining small matrices to make bigger ones. In fact, you made your first matrix by concatenating its individual elements. The pair of square brackets, `[]`, is the concatenation operator. For an example, start with the 4-by-4 magic square, `A`, and form

$$B = [A \quad A+32; \quad A+48 \quad A+16]$$

The result is an 8-by-8 matrix, obtained by joining the four submatrices.

$$B = \begin{bmatrix} 16 & 3 & 2 & 13 & 48 & 35 & 34 & 45 \\ 5 & 10 & 11 & 8 & 37 & 42 & 43 & 40 \\ 9 & 6 & 7 & 12 & 41 & 38 & 39 & 44 \\ 4 & 15 & 14 & 1 & 36 & 47 & 46 & 33 \\ 64 & 51 & 50 & 61 & 32 & 19 & 18 & 29 \\ 53 & 58 & 59 & 56 & 21 & 26 & 27 & 24 \\ 57 & 54 & 55 & 60 & 25 & 22 & 23 & 28 \\ 52 & 63 & 62 & 49 & 20 & 31 & 30 & 17 \end{bmatrix}$$

This matrix is half way to being another magic square. Its elements are a rearrangement of the integers 1:64. Its column sums are the correct value for an 8-by-8 magic square.

$$\begin{aligned} \text{sum}(B) \\ \text{ans} = \\ 260 \quad 260 \quad 260 \quad 260 \quad 260 \quad 260 \quad 260 \quad 260 \end{aligned}$$

But its row sums, `sum(B')'`, are not all the same. Further manipulation is necessary to make this a valid 8-by-8 magic square.

## Deleting Rows and Columns

You can delete rows and columns from a matrix using just a pair of square brackets. Start with

```
X = A;
```

Then, to delete the second column of X, use

```
X(:,2) = []
```

This changes X to

```
X =  
    16     2    13  
     5    11     8  
     9     7    12  
     4    14     1
```

If you delete a single element from a matrix, the result isn't a matrix anymore. So, expressions like

```
X(1,2) = []
```

result in an error. However, using a single subscript deletes a single element, or sequence of elements, and reshapes the remaining elements into a row vector. So

```
X(2:2:10) = []
```

results in

```
X =  
    16     9     2     7    13    12     1
```

## More About Matrices and Arrays

This section shows you more about working with matrices and arrays, focusing on:

- Linear algebra
- Arrays
- Multivariate data

### Linear Algebra

Informally, the terms *matrix* and *array* are often used interchangeably. More precisely, a *matrix* is a two-dimensional numeric array that represents a *linear transformation*. The mathematical operations defined on matrices are the subject of *linear algebra*.

Dürer's magic square

```
A =  
    16     3     2    13  
     5    10    11     8  
     9     6     7    12  
     4    15    14     1
```

provides several examples that give a taste of MATLAB matrix operations. You've already seen the matrix transpose,  $A'$ . Adding a matrix to its transpose produces a *symmetric* matrix.

```
A + A'  
  
ans =  
    32     8    11    17  
     8    20    17    23  
    11    17    14    26  
    17    23    26     2
```

The multiplication symbol,  $*$ , denotes the *matrix* multiplication involving inner products between rows and columns. Multiplying the transpose of a matrix by the original matrix also produces a symmetric matrix.

```
A' * A
```

```
ans =
    378    212    206    360
    212    370    368    206
    206    368    370    212
    360    206    212    378
```

The determinant of this particular matrix happens to be zero, indicating that the matrix is *singular*.

```
d = det(A)
```

```
d =
     0
```

The reduced row echelon form of A is not the identity.

```
R = rref(A)
```

```
R =
     1     0     0     1
     0     1     0    -3
     0     0     1     3
     0     0     0     0
```

Since the matrix is singular, it does not have an inverse. If you try to compute the inverse with

```
X = inv(A)
```

you will get a warning message

```
Warning: Matrix is close to singular or badly scaled.
Results may be inaccurate. RCOND = 1.175530e-017.
```

Roundoff error has prevented the matrix inversion algorithm from detecting exact singularity. But the value of `rcond`, which stands for *reciprocal condition estimate*, is on the order of `eps`, the floating-point relative precision, so the computed inverse is unlikely to be of much use.

The eigenvalues of the magic square are interesting.

```
e = eig(A)
```

```
e =  
34.0000  
8.0000  
0.0000  
-8.0000
```

One of the eigenvalues is zero, which is another consequence of singularity. The largest eigenvalue is 34, the magic sum. That's because the vector of all ones is an eigenvector.

```
v = ones(4,1)
```

```
v =  
1  
1  
1  
1
```

```
A*v
```

```
ans =  
34  
34  
34  
34
```

When a magic square is scaled by its magic sum,

```
P = A/34
```

the result is a *doubly stochastic* matrix whose row and column sums are all one.

```
P =  
0.4706    0.0882    0.0588    0.3824  
0.1471    0.2941    0.3235    0.2353  
0.2647    0.1765    0.2059    0.3529  
0.1176    0.4412    0.4118    0.0294
```



Such matrices represent the transition probabilities in a *Markov process*. Repeated powers of the matrix represent repeated steps of the process. For our example, the fifth power

$$P^5$$

is

$$\begin{array}{cccc} 0.2507 & 0.2495 & 0.2494 & 0.2504 \\ 0.2497 & 0.2501 & 0.2502 & 0.2500 \\ 0.2500 & 0.2498 & 0.2499 & 0.2503 \\ 0.2496 & 0.2506 & 0.2505 & 0.2493 \end{array}$$

This shows that as  $k$  approaches infinity, all the elements in the  $k$ th power,  $P^k$ , approach  $1/4$ .

Finally, the coefficients in the characteristic polynomial

$$\text{poly}(A)$$

are

$$1 \quad -34 \quad -64 \quad 2176 \quad 0$$

This indicates that the characteristic polynomial

$$\det(A - \lambda I)$$

is

$$\lambda^4 - 34\lambda^3 - 64\lambda^2 + 2176\lambda$$

The constant term is zero, because the matrix is singular, and the coefficient of the cubic term is -34, because the matrix is magic!

## Arrays

When they are taken away from the world of linear algebra, matrices become two dimensional numeric arrays. Arithmetic operations on arrays are done element-by-element. This means that addition and subtraction are the same for arrays and matrices, but that multiplicative operations are different. MATLAB uses a dot, or decimal point, as part of the notation for multiplicative array operations.

The list of operators includes:

+	Addition
-	Subtraction
.*	Element-by-element multiplication
./	Element-by-element division
.\	Element-by-element left division
.^	Element-by-element power
.'	Unconjugated array transpose

If the Dürer magic square is multiplied by itself with array multiplication

```
A.*A
```

the result is an array containing the squares of the integers from 1 to 16, in an unusual order.

```
ans =
    256     9     4    169
     25    100    121    64
     81     36     49    144
     16    225    196     1
```

#### Building Tables

Array operations are useful for building tables. Suppose  $n$  is the column vector

```
n = (0:9)';
```

Then

```
pows = [n n.^2 2.^n]
```

builds a table of squares and powers of two.

```
pows =  
  0    0    1  
  1    1    2  
  2    4    4  
  3    9    8  
  4   16   16  
  5   25   32  
  6   36   64  
  7   49  128  
  8   64  256  
  9   81  512
```

The elementary math functions operate on arrays element by element. So

```
format short g  
x = (1:0.1:2)';  
logs = [x log10(x)]
```

builds a table of logarithms.

```
logs =  
  1.0          0  
  1.1    0.04139  
  1.2    0.07918  
  1.3    0.11394  
  1.4    0.14613  
  1.5    0.17609  
  1.6    0.20412  
  1.7    0.23045  
  1.8    0.25527  
  1.9    0.27875  
  2.0    0.30103
```

## Multivariate Data

MATLAB uses column-oriented analysis for multivariate statistical data. Each column in a data set represents a variable and each row an observation. The  $(i, j)$ th element is the  $i$ th observation of the  $j$ th variable.

As an example, consider a data set with three variables:

- Heart rate
- Weight
- Hours of exercise per week

For five observations, the resulting array might look like

```
D =  
    72    134    3.2  
    81    201    3.5  
    69    156    7.1  
    82    148    2.4  
    75    170    1.2
```

The first row contains the heart rate, weight, and exercise hours for patient 1, the second row contains the data for patient 2, and so on. Now you can apply many of MATLAB's data analysis functions to this data set. For example, to obtain the mean and standard deviation of each column:

```
mu = mean(D), sigma = std(D)  
  
mu =  
    75.8    161.8    3.48  
  
sigma =  
    5.6303    25.499    2.2107
```

For a list of the data analysis functions available in MATLAB, type

```
help datafun
```

If you have access to the Statistics Toolbox, type

```
help stats
```

## Scalar Expansion

Matrices and scalars can be combined in several different ways. For example, a scalar is subtracted from a matrix by subtracting it from each element. The average value of the elements in our magic square is 8.5, so

$$B = A - 8.5$$

forms a matrix whose column sums are zero.

$$B = \begin{bmatrix} 7.5 & -5.5 & -6.5 & 4.5 \\ -3.5 & 1.5 & 2.5 & -0.5 \\ 0.5 & -2.5 & -1.5 & 3.5 \\ -4.5 & 6.5 & 5.5 & -7.5 \end{bmatrix}$$

$$\text{sum}(B)$$

$$\text{ans} = \begin{bmatrix} 0 & 0 & 0 & 0 \end{bmatrix}$$

With scalar expansion, MATLAB assigns a specified scalar to all indices in a range. For example,

$$B(1:2,2:3) = 0$$

zeros out a portion of B

$$B = \begin{bmatrix} 7.5 & 0 & 0 & 4.5 \\ -3.5 & 0 & 0 & -0.5 \\ 0.5 & -2.5 & -1.5 & 3.5 \\ -4.5 & 6.5 & 5.5 & -7.5 \end{bmatrix}$$

## Logical Subscripting

The logical vectors created from logical and relational operations can be used to reference subarrays. Suppose  $X$  is an ordinary matrix and  $L$  is a matrix of the same size that is the result of some logical operation. Then  $X(L)$  specifies the elements of  $X$  where the elements of  $L$  are nonzero.

This kind of subscripting can be done in one step by specifying the logical operation as the subscripting expression. Suppose you have the following set of data.

```
x =
    2.1 1.7 1.6 1.5 NaN 1.9 1.8 1.5 5.1 1.8 1.4 2.2 1.6 1.8
```

The NaN is a marker for a missing observation, such as a failure to respond to an item on a questionnaire. To remove the missing data with logical indexing, use `finite(x)`, which is true for all finite numerical values and false for NaN and Inf.

```
x = x(finite(x))
x =
    2.1 1.7 1.6 1.5 1.9 1.8 1.5 5.1 1.8 1.4 2.2 1.6 1.8
```

Now there is one observation, 5.1, which seems to be very different from the others. It is an *outlier*. The following statement removes outliers, in this case those elements more than three standard deviations from the mean.

```
x = x(abs(x-mean(x)) <= 3*std(x))
x =
    2.1 1.7 1.6 1.5 1.9 1.8 1.5 1.8 1.4 2.2 1.6 1.8
```

For another example, highlight the location of the prime numbers in Dürer's magic square by using logical indexing and scalar expansion to set the nonprimes to 0.

```
A(~isprime(A)) = 0

A =
     0     3     2    13
     5     0    11     0
     0     0     7     0
     0     0     0     0
```

## The find Function

The `find` function determines the indices of array elements that meet a given logical condition. In its simplest form, `find` returns a column vector of indices. Transpose that vector to obtain a row vector of indices. For example,

```
k = find(isprime(A))'
```

picks out the locations, using one-dimensional indexing, of the primes in the magic square.

```
k =  
     2     5     9    10    11    13
```

Display those primes, as a row vector in the order determined by `k`, with

```
A(k)  
  
ans =  
     5     3     2    11     7    13
```

When you use `k` as a left-hand-side index in an assignment statement, the matrix structure is preserved.

```
A(k) = NaN  
  
A =  
    16    NaN    NaN    NaN  
    NaN    10    NaN     8  
     9     6    NaN    12  
     4    15    14     1
```

## Controlling Command Window Input and Output

So far, you have been using the MATLAB command line, typing commands and expressions, and seeing the results printed in the Command Window. This section describes how to:

- Control the appearance of the output values
- Suppress output from MATLAB commands
- Enter long commands at the command line
- Edit the command line

### The format Command

The `format` command controls the numeric format of the values displayed by MATLAB. The command affects only how numbers are displayed, not how MATLAB computes or saves them. Here are the different formats, together with the resulting output produced from a vector `x` with components of different magnitudes.

---

**Note** To ensure proper spacing, use a fixed-width font, such as Fixedsys or Courier.

---

```
x = [4/3 1.2345e-6]

format short

    1.3333    0.0000

format short e

    1.3333e+000    1.2345e-006

format short g

    1.3333    1.2345e-006
```



```
format long
    1.33333333333333  0.00000123450000
format long e
    1.33333333333333e+000  1.23450000000000e-006
format long g
    1.33333333333333  1.2345e-006
format bank
    1.33  0.00
format rat
    4/3  1/810045
format hex
    3ff5555555555555  3eb4b6231abfd271
```

If the largest element of a matrix is larger than  $10^3$  or smaller than  $10^{-3}$ , MATLAB applies a common scale factor for the short and long formats.

In addition to the format commands shown above

```
format compact
```

suppresses many of the blank lines that appear in the output. This lets you view more information on a screen or window. If you want more control over the output format, use the `sprintf` and `fprintf` functions.

## Suppressing Output

If you simply type a statement and press **Return** or **Enter**, MATLAB automatically displays the results on screen. However, if you end the line with a semicolon, MATLAB performs the computation but does not display any output. This is particularly useful when you generate large matrices. For example,

```
A = magic(100);
```

## Entering Long Command Lines

If a statement does not fit on one line, use three periods, . . . , followed by **Return** or **Enter** to indicate that the statement continues on the next line. For example,

```
s = 1 - 1/2 + 1/3 - 1/4 + 1/5 - 1/6 + 1/7 ...  
      - 1/8 + 1/9 - 1/10 + 1/11 - 1/12;
```

Blank spaces around the =, +, and - signs are optional, but they improve readability.

## Command Line Editing

Various arrow and control keys on your keyboard allow you to recall, edit, and reuse commands you have typed earlier. For example, suppose you mistakenly enter

```
rho = (1 + sqrt(5))/2
```

You have misspelled sqrt. MATLAB responds with

```
Undefined function or variable 'sqrt'.
```

Instead of retyping the entire line, simply press the  $\uparrow$  key. The misspelled command is redisplayed. Use the  $\leftarrow$  key to move the cursor over and insert the missing r. Repeated use of the  $\uparrow$  key recalls earlier lines. Typing a few characters and then the  $\uparrow$  key finds a previous line that begins with those characters. You can also copy previously executed commands from the Command History. For more information, see “Command History” on page 2-7.

The list of available command line editing keys is different on different computers. Experiment to see which of the following keys is available on your machine. (Many of these keys will be familiar to users of the Emacs editor.)

<b>↑</b>	<b>Ctrl+p</b>	Recall previous line
<b>↓</b>	<b>Ctrl+n</b>	Recall next line
<b>←</b>	<b>Ctrl+b</b>	Move back one character
<b>→</b>	<b>Ctrl+f</b>	Move forward one character
<b>Ctrl+→</b>	<b>Ctrl+r</b>	Move right one word
<b>Ctrl+←</b>	<b>Ctrl+l</b>	Move left one word
<b>Home</b>	<b>Ctrl+a</b>	Move to beginning of line
<b>End</b>	<b>Ctrl+e</b>	Move to end of line
<b>Esc</b>	<b>Ctrl+u</b>	Clear line
<b>Del</b>	<b>Ctrl+d</b>	Delete character at cursor
<b>Backspace</b>	<b>Ctrl+h</b>	Delete character before cursor
	<b>Ctrl+k</b>	Delete to end of line



# Graphics

---

<b>Basic Plotting</b> . . . . .	4-2
<b>Editing Plots</b> . . . . .	4-14
<b>Mesh and Surface Plots</b> . . . . .	4-18
<b>Images</b> . . . . .	4-22
<b>Printing Graphics</b> . . . . .	4-24
<b>Handle Graphics</b> . . . . .	4-26
<b>Graphics User Interfaces</b> . . . . .	4-33
<b>Animations</b> . . . . .	4-34

## Basic Plotting

MATLAB has extensive facilities for displaying vectors and matrices as graphs, as well as annotating and printing these graphs. This section describes a few of the most important graphics functions and provides examples of some typical applications.

### Creating a Plot

The `plot` function has different forms, depending on the input arguments. If `y` is a vector, `plot(y)` produces a piecewise linear graph of the elements of `y` versus the index of the elements of `y`. If you specify two vectors as arguments, `plot(x,y)` produces a graph of `y` versus `x`.

For example, these statements use the colon operator to create a vector of `x` values ranging from zero to  $2\pi$ , compute the sine of these values, and plot the result.

```
x = 0:pi/100:2*pi;  
y = sin(x);  
plot(x,y)
```

Now label the axes and add a title. The characters `\pi` create the symbol  $\pi$ .

```
xlabel('x = 0:2\pi')  
ylabel('Sine of x')  
title('Plot of the Sine Function','FontSize',12)
```

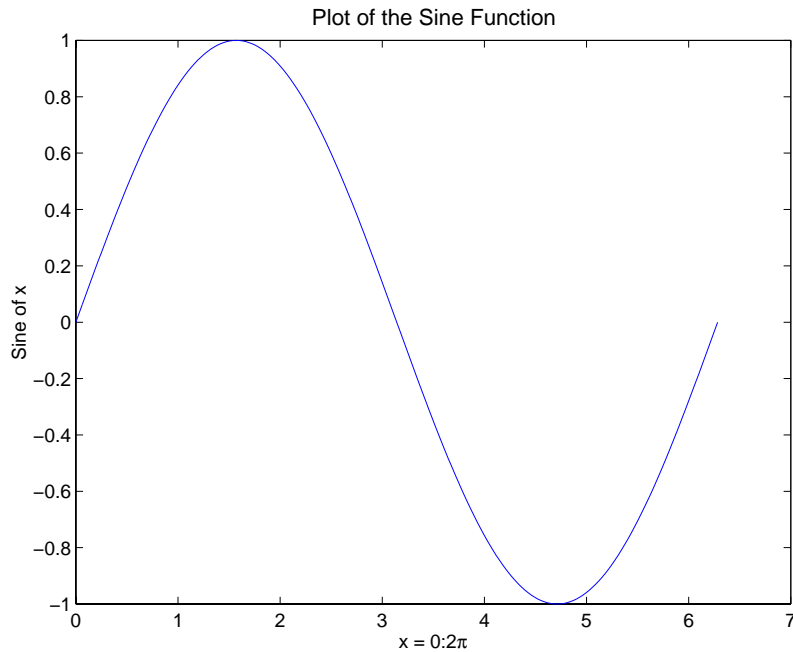

## Multiple Data Sets in One Graph

Multiple x-y pair arguments create multiple graphs with a single call to `plot`. MATLAB automatically cycles through a predefined (but user settable) list of colors to allow discrimination between each set of data. For example, these statements plot three related functions of  $x$ , each curve in a separate distinguishing color.

```
y2 = sin(x-.25);  
y3 = sin(x-.5);  
plot(x,y,x,y2,x,y3)
```

The `legend` command provides an easy way to identify the individual plots.

```
legend('sin(x)', 'sin(x-.25)', 'sin(x-.5)')
```

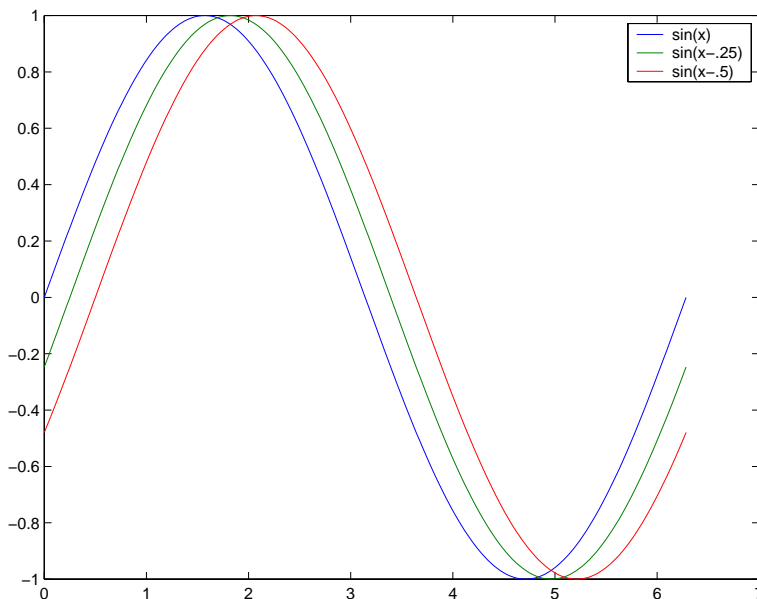

## Specifying Line Styles and Colors

It is possible to specify color, line styles, and markers (such as plus signs or circles) when you plot your data using the `plot` command.

```
plot(x,y,'color_style_marker')
```

`color_style_marker` is a string containing from one to four characters (enclosed in single quotation marks) constructed from a color, a line style, and a marker type:

- Color strings are 'c', 'm', 'y', 'r', 'g', 'b', 'w', and 'k'. These correspond to cyan, magenta, yellow, red, green, blue, white, and black.
- Linestyle strings are '-' for solid, '--' for dashed, ':' for dotted, '-.' for dash-dot. Omit the linestyle for no line.
- The marker types are '+', 'o', '\*', and 'x' and the filled marker types 's' for square, 'd' for diamond, '^' for up triangle, 'v' for down triangle, '>' for right triangle, and '<' for left triangle.



for right triangle, '<' for left triangle, 'p' for pentagram, 'h' for hexagram, and none for no marker.

You can also edit color, line style, and markers interactively. See “Editing Plots” on page 4-14 for more information.

## Plotting Lines and Markers

If you specify a marker type but not a linestyle, MATLAB draws only the marker. For example,

```
plot(x,y,'ks')
```

plots black squares at each data point, but does not connect the markers with a line.

The statement

```
plot(x,y,'r:+')
```

plots a red dotted line and places plus sign markers at each data point. You may want to use fewer data points to plot the markers than you use to plot the lines. This example plots the data twice using a different number of points for the dotted line and marker plots.

```
x1 = 0:pi/100:2*pi;  
x2 = 0:pi/10:2*pi;  
plot(x1,sin(x1),'r:',x2,sin(x2),'r+')
```

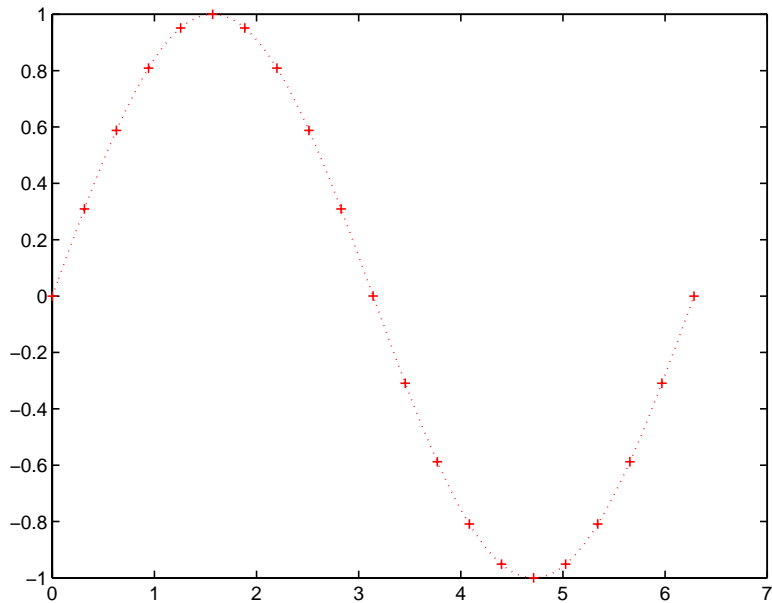

## Imaginary and Complex Data

When the arguments to `plot` are complex, the imaginary part is ignored *except* when `plot` is given a single complex argument. For this special case, the command is a shortcut for a plot of the real part versus the imaginary part. Therefore,

```
plot(Z)
```

where  $Z$  is a complex vector or matrix, is equivalent to

```
plot(real(Z), imag(Z))
```

For example,

```
t = 0:pi/10:2*pi;  
plot(exp(i*t), '-o')  
axis equal
```

draws a 20-sided polygon with little circles at the vertices. The command, `axis equal`, makes the individual tick mark increments on the  $x$ - and  $y$ -axes the same length, which makes this plot more circular in appearance.

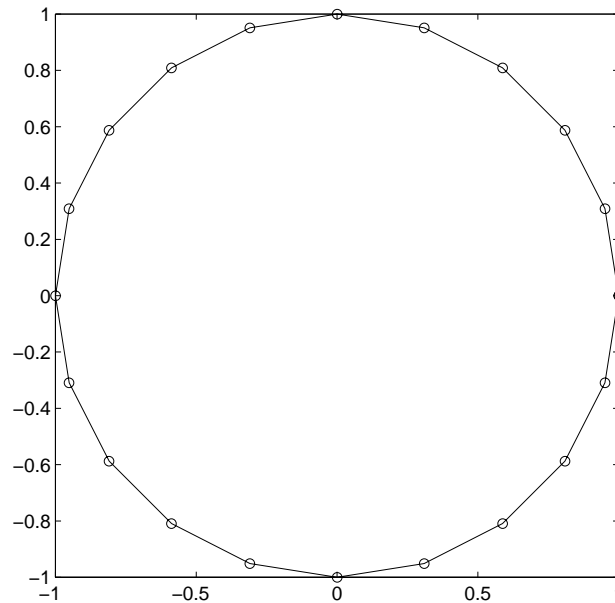

## Adding Plots to an Existing Graph

The `hold` command enables you to add plots to an existing graph. When you type

```
hold on
```

MATLAB does not replace the existing graph when you issue another plotting command; it adds the new data to the current graph, rescaling the axes if necessary.

For example, these statements first create a contour plot of the peaks function, then superimpose a pseudocolor plot of the same function.

```
[x,y,z] = peaks;  
contour(x,y,z,20,'k')  
hold on
```

```
pcolor(x,y,z)
shading interp
hold off
```

The `hold on` command causes the `pcolor` plot to be combined with the contour plot in one figure.

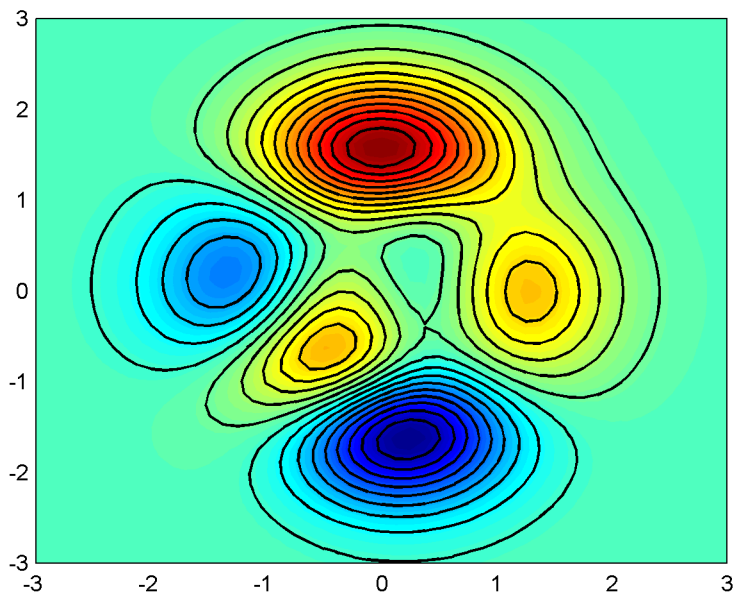

### Figure Windows

Graphing functions automatically open a new figure window if there are no figure windows already on the screen. If a figure window exists, MATLAB uses that window for graphics output. If there are multiple figure windows open, MATLAB targets the one that is designated the “current figure” (the last figure used or clicked in).

To make an existing figure window the current figure, you can click the mouse while the pointer is in that window or you can type

```
figure(n)
```

where  $n$  is the number in the figure title bar. The results of subsequent graphics commands are displayed in this window.

To open a new figure window and make it the current figure, type

```
figure
```

## Multiple Plots in One Figure

The `subplot` command enables you to display multiple plots in the same window or print them on the same piece of paper. Typing

```
subplot(m,n,p)
```

partitions the figure window into an  $m$ -by- $n$  matrix of small subplots and selects the  $p$ th subplot for the current plot. The plots are numbered along first the top row of the figure window, then the second row, and so on. For example, these statements plot data in four different subregions of the figure window.

```
t = 0:pi/10:2*pi;  
[X,Y,Z] = cylinder(4*cos(t));  
subplot(2,2,1); mesh(X)  
subplot(2,2,2); mesh(Y)  
subplot(2,2,3); mesh(Z)  
subplot(2,2,4); mesh(X,Y,Z)
```

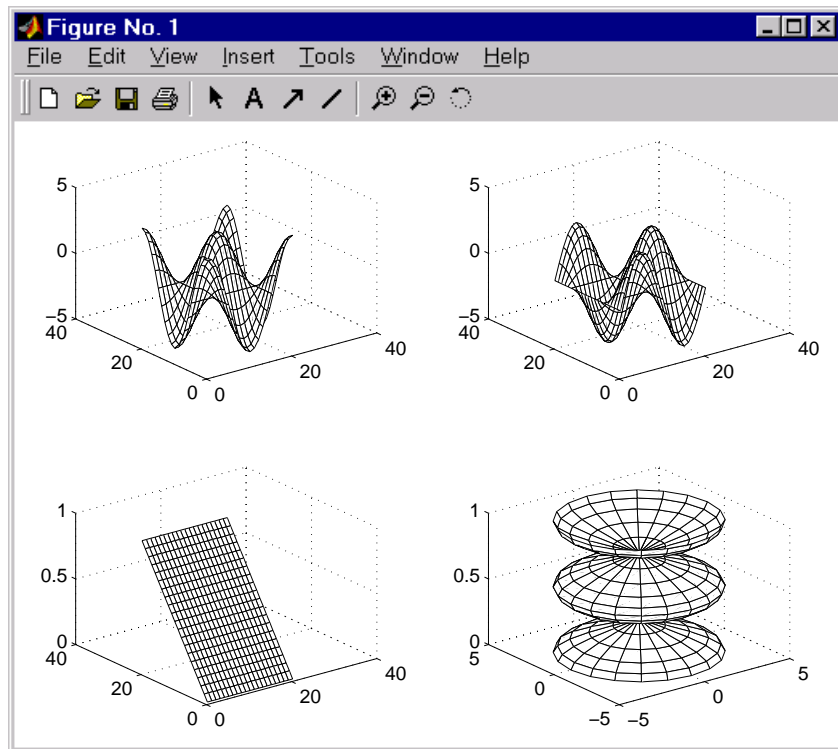

## Controlling the Axes

The axis command supports a number of options for setting the scaling, orientation, and aspect ratio of plots. You can also set these options interactively. See “Editing Plots” on page 4-14 for more information.

### Setting Axis Limits

By default, MATLAB finds the maxima and minima of the data to choose the axis limits to span this range. The axis command enables you to specify your own limits

```
axis([xmin xmax ymin ymax])
```

or for three-dimensional graphs,

```
axis([xmin xmax ymin ymax zmin zmax])
```

Use the command

```
axis auto
```

to re-enable MATLAB's automatic limit selection.

### Setting Axis Aspect Ratio

`axis` also enables you to specify a number of predefined modes. For example,

```
axis square
```

makes the  $x$ -axes and  $y$ -axes the same length.

```
axis equal
```

makes the individual tick mark increments on the  $x$ - and  $y$ -axes the same length. This means

```
plot(exp(i*[0:pi/10:2*pi]))
```

followed by either `axis square` or `axis equal` turns the oval into a proper circle.

```
axis auto normal
```

returns the axis scaling to its default, automatic mode.

### Setting Axis Visibility

You can use the `axis` command to make the axis visible or invisible.

```
axis on
```

makes the axis visible. This is the default.

```
axis off
```

makes the axis invisible.

### Setting Grid Lines

The `grid` command toggles grid lines on and off. The statement

```
grid on
```

turns the grid lines on and

```
grid off
```

turns them back off again.

### Axis Labels and Titles

The `xlabel`, `ylabel`, and `zlabel` commands add  $x$ -,  $y$ -, and  $z$ -axis labels. The `title` command adds a title at the top of the figure and the `text` function inserts text anywhere in the figure. A subset of TeX notation produces Greek letters. You can also set these options interactively. See “Editing Plots” on page 4-14 for more information.

```
t = -pi:pi/100:pi;  
y = sin(t);  
plot(t,y)  
axis([-pi pi -1 1])  
xlabel('-\pi \leq {\itt} \leq \pi')  
ylabel('sin(t)')  
title('Graph of the sine function')  
text(1,-1/3, '{\itNote the odd symmetry.}')
```



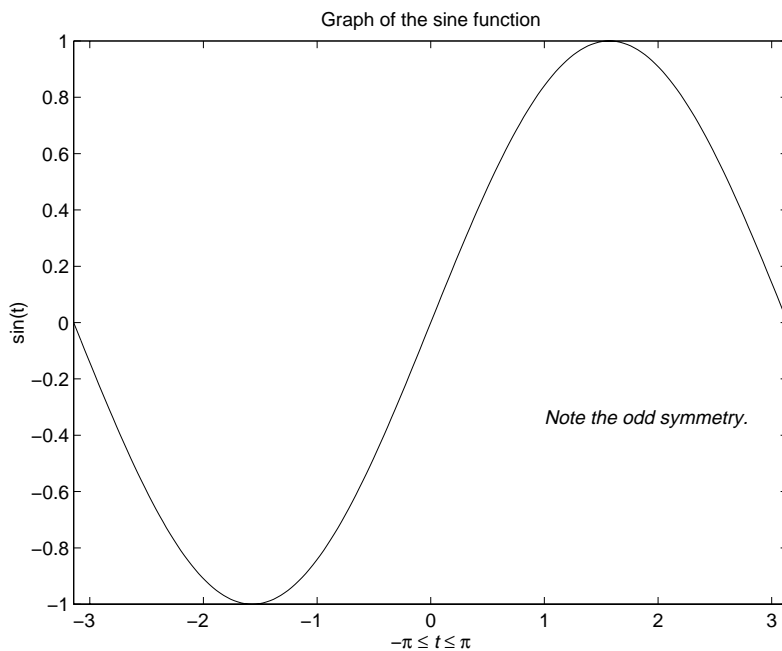

## Saving a Figure

To save a figure, select **Save** from the **File** menu. To save it using a graphics format, such as TIFF, for use with other applications, select **Export** from the **File** menu. You can also save from the command line – use the `saveas` command, including any options to save the figure in a different format.

## Editing Plots

MATLAB formats a graph to provide readability, setting the scale of axes, including tick marks on the axes, and using color and line style to distinguish the plots in the graph. However, if you are creating presentation graphics, you may want to change this default formatting or add descriptive labels, titles, legends and other annotations to help explain your data.

MATLAB supports two ways to edit the plots you create.

- Using the mouse to select and edit objects interactively
- Using MATLAB functions at the command-line or in an M-file

### Interactive Plot Editing

If you enable plot editing mode in the MATLAB figure window, you can perform point-and-click editing of the objects in your graph. In this mode, you select the object or objects you want to edit by double-clicking on it. This starts the Property Editor which provides access to properties of the object that control its appearance and behavior.

For more information about interactive editing, see “Using Plot Editing Mode” on page 4-15. For information about editing object properties in plot editing mode, see “Using the Property Editor” on page 4-16.

---

**Note** Plot editing mode provides an alternative way to access the properties of MATLAB graphic objects. However, you can only access a subset of object properties through this mechanism. You may need to use a combination of interactive editing and command line editing to achieve the effect you desire.

---

### Using Functions to Edit Graphs

If you prefer to work from the MATLAB command line or if you are creating an M-file, you can use MATLAB commands to edit the graphs you create. Taking advantage of MATLAB’s Handle Graphics system, you can use the `set` and `get` commands to change the properties of the objects in a graph. For more information about using command line, see “Handle Graphics” on page 4-26.

## Using Plot Editing Mode

The MATLAB figure window supports a point-and-click style editing mode that you can use to customize the appearance of your graph. The following illustration shows a figure window with plot editing mode enabled and labels the main plot editing mode features.

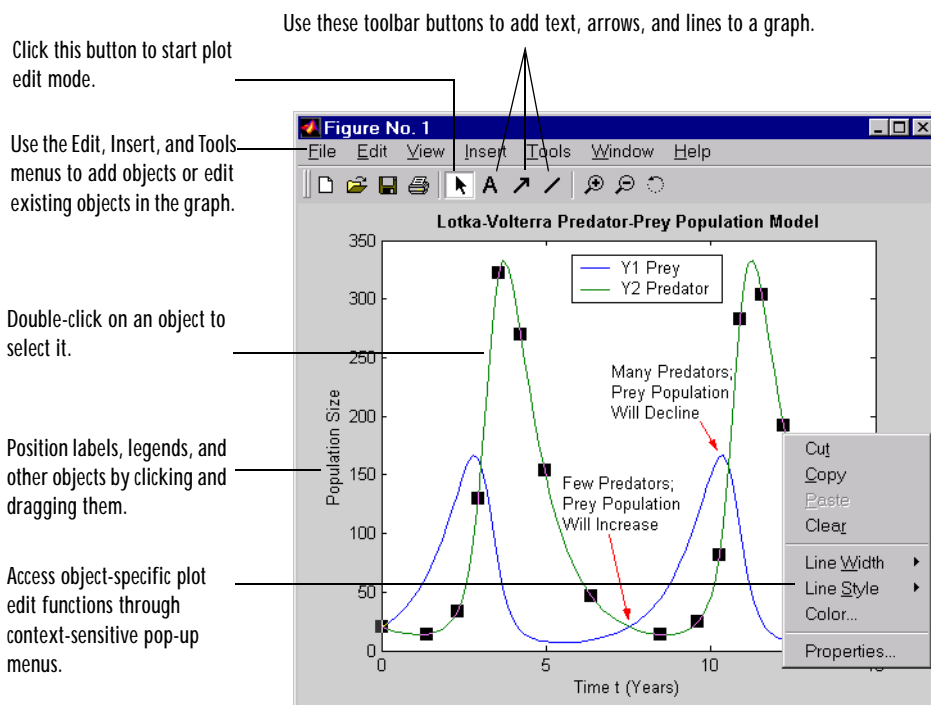

## Using the Property Editor

In plot editing mode, you can use a graphical user interface, called the Property Editor, to edit the properties of objects in the graph. The Property Editor provides access to many properties of the root, figure, axes, line, light, patch, image, surfaces rectangle, and text objects. For example, using the Property Editor, you can change the thickness of a line, add titles and axes labels, add lights, and perform many other plot editing tasks.

This figure shows the components of the Property Editor interface.

Use these buttons to move back and forth among the graphics objects you have edited.

Use the navigation bar to select the object you want to edit.

Click on a tab to view a group of properties.

Click here to view a list of values for this field.

Check this checkbox to see the effect of your changes as you make them..

Click OK to apply your changes and dismiss the Property Editor.

Click Cancel to dismiss the Property Editor without applying your changes.

Click Apply to apply your changes without dismissing the Property Editor.

Click Help to get information about particular properties.

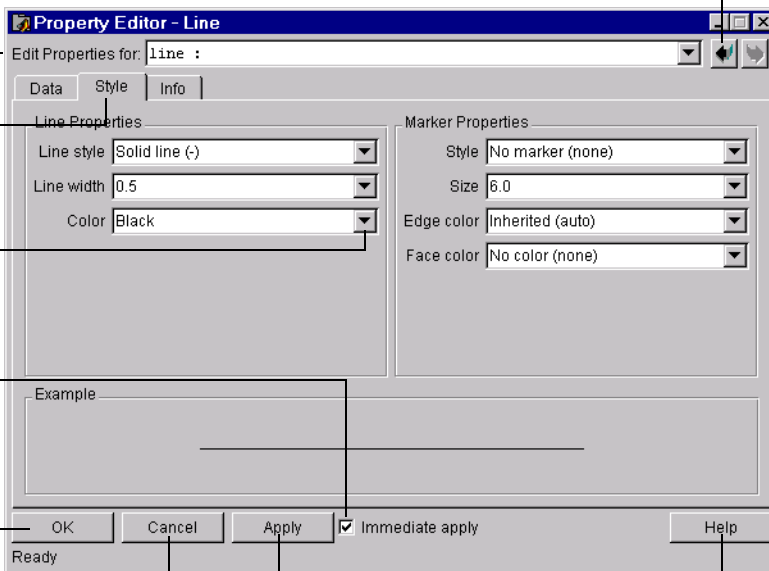

### Starting the Property Editor

You start the Property Editor by double-clicking on an object in a graph, such as a line, or by right-clicking on an object and selecting the **Properties** option from the object's context menu.

You can also start the Property Editor by selecting either the **Figure Properties**, **Axes Properties**, or **Current Object Properties** from the figure window **Edit** menu. These options automatically enable plot editing mode, if it is not already enabled.

Once you start the Property Editor, keep it open throughout an editing session. It provides access to all the objects in the graph. If you click on another object in the graph, the Property Editor displays the set of panels associated with that object type. You can also use the Property Editor's navigation bar to select an object in the graph to edit.

## Mesh and Surface Plots

MATLAB defines a surface by the  $z$ -coordinates of points above a grid in the  $x$ - $y$  plane, using straight lines to connect adjacent points. The `mesh` and `surf` plotting functions display surfaces in three dimensions. `mesh` produces wireframe surfaces that color only the lines connecting the defining points. `surf` displays both the connecting lines and the faces of the surface in color.

### Visualizing Functions of Two Variables

To display a function of two variables,  $z = f(x,y)$ :

- Generate  $X$  and  $Y$  matrices consisting of repeated rows and columns, respectively, over the domain of the function.
- Use  $X$  and  $Y$  to evaluate and graph the function.

The `meshgrid` function transforms the domain specified by a single vector or two vectors  $x$  and  $y$  into matrices  $X$  and  $Y$  for use in evaluating functions of two variables. The rows of  $X$  are copies of the vector  $x$  and the columns of  $Y$  are copies of the vector  $y$ .

#### Example – Graphing the sinc Function

This example evaluates and graphs the two-dimensional *sinc* function,  $\sin(r)/r$ , between the  $x$  and  $y$  directions.  $R$  is the distance from origin, which is at the center of the matrix. Adding `eps` (a MATLAB command that returns the smallest floating-point number on your system) avoids the indeterminate  $0/0$  at the origin.

```
[X,Y] = meshgrid(-8:.5:8);  
R = sqrt(X.^2 + Y.^2) + eps;  
Z = sin(R)./R;  
mesh(X,Y,Z, 'EdgeColor', 'black')
```

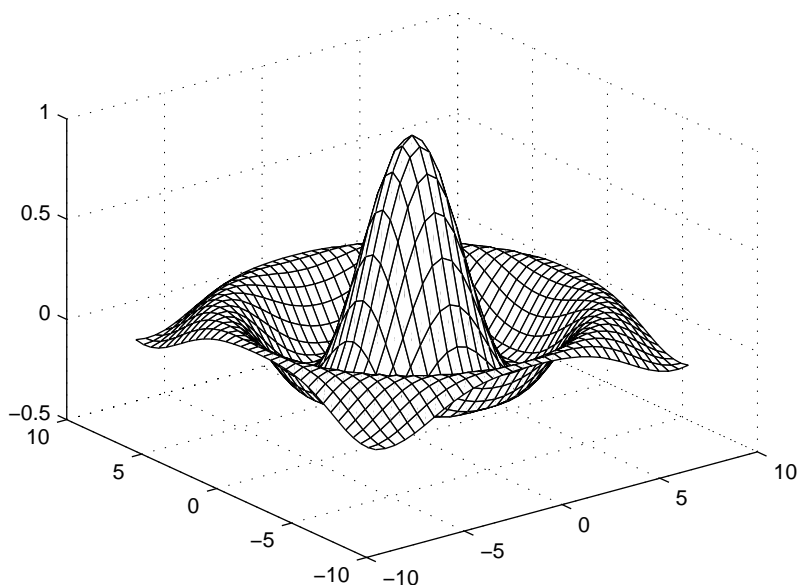

By default, MATLAB colors the mesh using the current colormap. However, this example uses a single-colored mesh by specifying the `EdgeColor` surface property. See the surface reference page for a list of all surface properties.

You can create a transparent mesh by disabling hidden line removal.

```
hidden off
```

See the hidden reference page for more information on this option.

### Example – Colored Surface Plots

A surface plot is similar to a mesh plot except the rectangular faces of the surface are colored. The color of the faces is determined by the values of  $Z$  and the colormap (a colormap is an ordered list of colors). These statements graph the *sinc* function as a surface plot, select a colormap, and add a color bar to show the mapping of data to color.

```
surf(X,Y,Z)  
colormap hsv  
colorbar
```

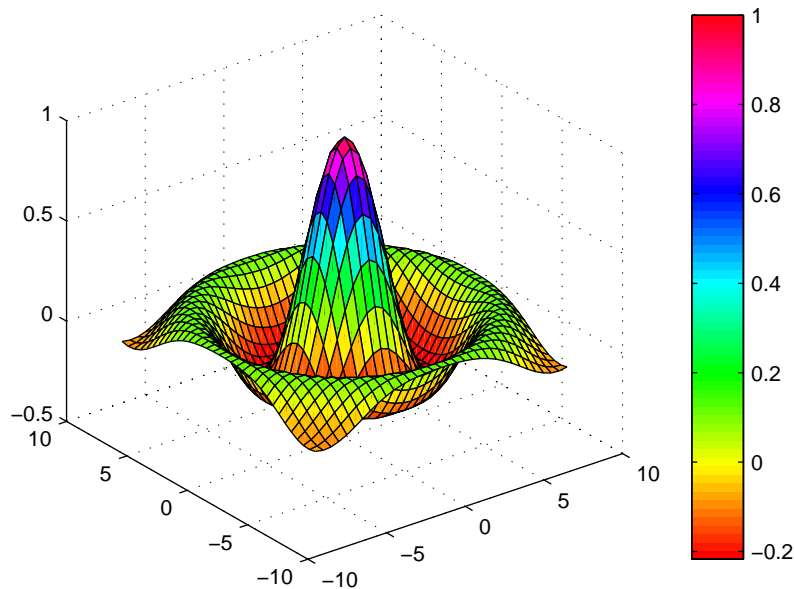

See the colormap reference page for information on colormaps.

### Surface Plots with Lighting

Lighting is the technique of illuminating an object with a directional light source. In certain cases, this technique can make subtle differences in surface shape easier to see. Lighting can also be used to add realism to three-dimensional graphs.

This example uses the same surface as the previous examples, but colors it red and removes the mesh lines. A light object is then added to the left of the “camera” (that is the location in space from where you are viewing the surface).



After adding the light and setting the lighting method to phong, use the view command to change the view point so you are looking at the surface from a different point in space (an azimuth of -15 and an elevation of 65 degrees). Finally, zoom in on the surface using the toolbar zoom mode.

```
surf(X,Y,Z,'FaceColor','red','EdgeColor','none');  
camlight left; lighting phong  
view(-15,65)
```

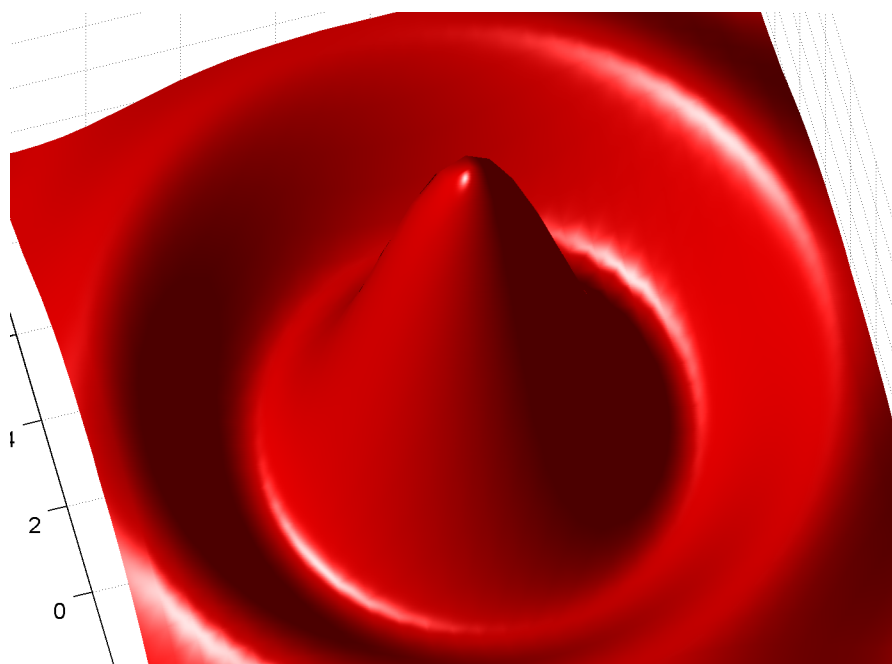

## Images

Two-dimensional arrays can be displayed as *images*, where the array elements determine brightness or color of the images. For example, the statements

```
load durer
whos
Name           Size           Bytes  Class
-----
X              648x509         2638656 double array
caption        2x28             112 char array
map            128x3            3072 double array
```

load the file `durer.mat`, adding three variables to the workspace. The matrix `X` is a 648-by-509 matrix and `map` is a 128-by-3 matrix that is the colormap for this image.

---

**Note** MAT-files, such as `durer.mat`, are binary files that can be created on one platform and later read by MATLAB on a different platform.

---

The elements of `X` are integers between 1 and 128, which serve as indices into the colormap, `map`. Then

```
image(X)
colormap(map)
axis image
```

reproduces Dürer's etching shown at the beginning of this book. A high resolution scan of the magic square in the upper right corner is available in another file. Type

```
load detail
```

and then use the uparrow key on your keyboard to reexecute the `image`, `colormap`, and `axis` commands. The statement

```
colormap(hot)
```

adds some twentieth century colorization to the sixteenth century etching. The function `hot` generates a colormap containing shades of reds, oranges, and

yellows. Typically a given image matrix has a specific colormap associated with it. See the colormap reference page for a list of other predefined colormaps.

## Printing Graphics

You can print a MATLAB figure directly on a printer connected to your computer or you can export the figure to one of the standard graphic file formats supported by MATLAB. There are two ways to print and export figures:

- Using the **Print** option under the **File** menu
- Using the print command

### Printing from the Menu

There are four menu options under the **File** menu that pertain to printing:

- The **Page Setup** option displays a dialog box that enables you to adjust characteristics of the figure on the printed page.
- The **Print Setup** option displays a dialog box that sets printing defaults, but does not actually print the figure.
- The **Print Preview** option enables you to view the figure the way it will look on the printed page.
- The **Print** option displays a dialog box that lets you select standard printing options and print the figure.

Generally, use **Print Preview** to determine whether the printed output is what you want. If not, use the **Page Setup** dialog box to change the output settings. Select the **Page Setup** dialog box **Help** button to display information on how to set up the page.

### Exporting Figure to Graphics Files

The **Export** option under the **File** menu enables you to export the figure to a variety of standard graphics file formats.

### Using the Print Command

The print command provides more flexibility in the type of output sent to the printer and allows you to control printing from M-files. The result can be sent directly to your default printer or stored in a specified file. A wide variety of output formats, including TIFF, JPEG, and PostScript, is available.

For example, this statement saves the contents of the current figure window as color Encapsulated Level 2 PostScript in the file called `magicsquare.eps`. It

also includes a TIFF preview, which enables most word processors to display the picture

```
print -depsc2 -tiff magicssquare.eps
```

To save the same figure as a TIFF file with a resolution of 200 dpi, use the command

```
print -dtiff -r200 magicssquare.tiff
```

If you type `print` on the command line,

```
print
```

MATLAB prints the current figure on your default printer.

## Handle Graphics

When you use a plotting command, MATLAB creates the graph using various graphics objects, such as lines, text, and surfaces (see “Graphics Objects” on page 4-26 for a complete list). All graphics objects have properties that control the appearance and behavior of the object. MATLAB enables you to query the value of each property and set the value of most properties.

Whenever MATLAB creates a graphics object, it assigns an identifier (called a handle) to the object. You can use this handle to access the object’s properties. Handle Graphics is useful if you want to:

- Modify the appearance of graphs.
- Create custom plotting commands by writing M-files that create and manipulate objects directly.

## Graphics Objects

Graphics objects are the basic elements used to display graphics and user interface elements. This table lists the graphics objects.

Object	Description
Root	Top of the hierarchy corresponding to the computer screen
Figure	Window used to display graphics and user interfaces
Axes	Axes for displaying graphs in a figure
Uicontrol	User interface control that executes a function in response to user interaction
Uimenu	User-defined figure window menu
Uicontextmenu	Pop-up menu invoked by right clicking on a graphics object
Image	Two-dimensional pixel-based picture
Light	Light sources that affect the coloring of patch and surface objects

Object	Description
Line	Line used by functions such as <code>plot</code> , <code>plot3</code> , <code>semilogx</code>
Patch	Filled polygon with edges
Rectangle	Two-dimensional shape varying from rectangles to ovals
Surface	Three-dimensional representation of matrix data created by plotting the value of the data as heights above the $x$ - $y$ plane
Text	Character string

### Object Hierarchy

The objects are organized in a tree structured hierarchy reflecting their interdependence. For example, line objects require axes objects as a frame of reference. In turn, axes objects exist only within figure objects. This diagram illustrates the tree structure.

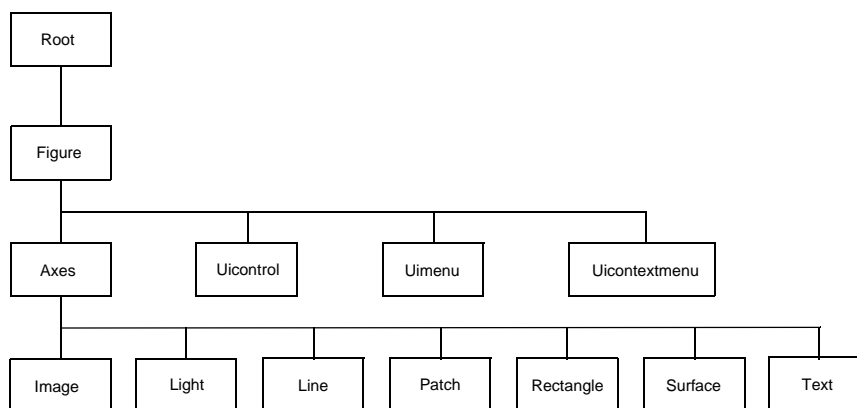

### Creating Objects

Each object has an associated function that creates the object. These functions have the same name as the objects they create. For example, the `text` function creates text objects, the `figure` function creates figure objects, and so on. MATLAB's high-level graphics functions (like `plot` and `surf`) call the

appropriate low-level function to draw their respective graphics. For more information about an object and a description of its properties, see the reference page for the object's creation function. Object creation functions have the same name as the object. For example, the object creation function for axes objects is called `axes`.

### Commands for Working with Objects

This table lists commands commonly used when working with objects.

Function	Purpose
<code>copyobj</code>	Copy graphics object
<code>delete</code>	Delete an object
<code>findobj</code>	Find the handle of objects having specified property values
<code>gca</code>	Return the handle of the current axes
<code>gcf</code>	Return the handle of the current figure
<code>gco</code>	Return the handle of the current object
<code>get</code>	Query the value of an objects properties
<code>set</code>	Set the value of an objects properties

### Setting Object Properties

All object properties have default values. However, you may find it useful to change the settings of some properties to customize your graph. There are two ways to set object properties:

- Specify values for properties when you create the object.
- Set the property value on an object that already exists.

### Setting Properties from Plotting Commands

You can specify object property values as arguments to object creation functions as well as with plotting function, such as `plot`, `mesh`, and `surf`.



For example, plotting commands that create lines or surfaces enable you to specify property name/property value pairs as arguments. The command

```
plot(x,y,'LineWidth',1.5)
```

plots the data in the variables *x* and *y* using lines having a `LineWidth` property set to 1.5 points (one point = 1/72 inch). You can set any line object property this way.

### Setting Properties of Existing Objects

To modify the property values of existing objects, you can use the `set` command or, if plot editing mode is enabled, the Property Editor. The Property Editor provides a graphical user interface to many object properties. This section describes how to use the `set` command. See “Using the Property Editor” on page 4-16 for more information.

Many plotting commands can return the handles of the objects created so you can modify the objects using the `set` command. For example, these statements plot a five-by-five matrix (creating five lines, one per column) and then set the `Marker` to a square and the `MarkerFaceColor` to green.

```
h = plot(magic(5));  
set(h,'Marker','s',MarkerFaceColor,'g')
```

In this case, *h* is a vector containing five handles, one for each of the five lines in the plot. The `set` statement sets the `Marker` and `MarkerFaceColor` properties of all lines to the same values.

### Setting Multiple Property Values

If you want to set the properties of each line to a different value, you can use cell arrays to store all the data and pass it to the `set` command. For example, create a plot and save the line handles.

```
h = plot(magic(5));
```

Suppose you want to add different markers to each line and color the marker's face color to the same color as the line. You need to define two cell arrays – one containing the property names and the other containing the desired values of the properties.

The `prop_name` cell array contains two elements.

```
prop_name(1) = {'Marker'};
```

```
prop_name(2) = {'MarkerFaceColor'};
```

The `prop_values` cell array contains 10 values – five values for the `Marker` property and five values for the `MarkerFaceColor` property. Notice that `prop_values` is a two-dimensional cell array. The first dimension indicates which handle in `h` the values apply to and the second dimension indicates which property the value is assigned to.

```
prop_values(1,1) = {'s'};  
prop_values(1,2) = {get(h(1), 'Color')};  
prop_values(2,1) = {'d'};  
prop_values(2,2) = {get(h(2), 'Color')};  
prop_values(3,1) = {'o'};  
prop_values(3,2) = {get(h(3), 'Color')};  
prop_values(4,1) = {'p'};  
prop_values(4,2) = {get(h(4), 'Color')};  
prop_values(5,1) = {'h'};  
prop_values(5,2) = {get(h(5), 'Color')};
```

The `MarkerFaceColor` is always assigned the value of the corresponding line's color (obtained by getting the line's `Color` property with the `get` command).

After defining the cell arrays, call `set` to specify the new property values.

```
set(h,prop_name,prop_values)
```

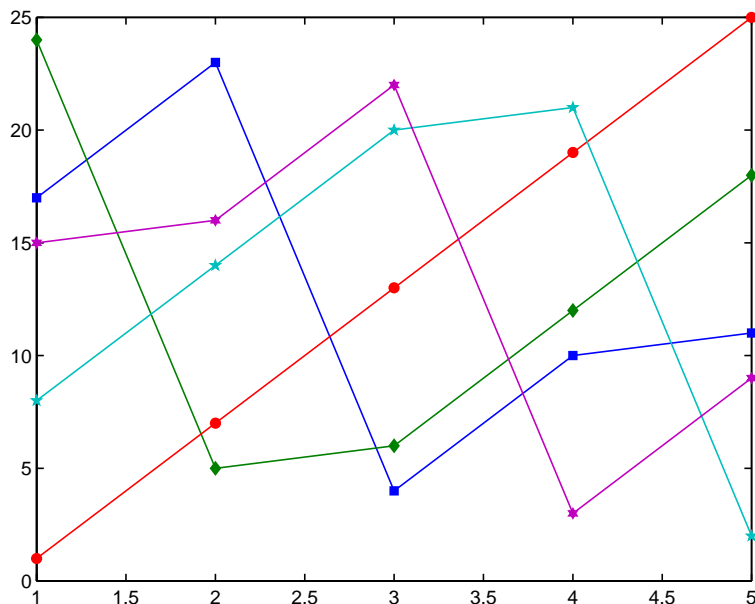

## Finding the Handles of Existing Objects

The `findobj` command enables you to obtain the handles of graphics objects by searching for objects with particular property values. With `findobj` you can specify the value of any combination of properties, which makes it easy to pick one object out of many. For example, you may want to find the blue line with square marker having blue face color.

You can also specify which figures or axes to search, if there is more than one. The following sections provide examples illustrating how to use `findobj`.

### Finding All Objects of a Certain Type

Since all objects have a `Type` property that identifies the type of object, you can find the handles of all occurrences of a particular type of object. For example,

```
h = findobj('Type','line');
```

finds the handles of all line objects.

### Finding Objects with a Particular Property

You can specify multiple properties to narrow the search. For example,

```
h = findobj('Type','line','Color','r','LineStyle',':');
```

finds the handles of all red, dotted lines.

### Limiting the Scope of the Search

You can specify the starting point in the object hierarchy by passing the handle of the starting figure or axes as the first argument. For example,

```
h = findobj(gca,'Type','text','String','\pi/2');
```

finds the string  $\pi/2$  only within the current axes.

### Using findobj as an Argument

Since `findobj` returns the handles it finds, you can use it in place of the handle argument. For example,

```
set(findobj('Type','line','Color','red'),'LineStyle',':')
```

finds all red lines and sets their line style to dotted.

## Graphics User Interfaces

Here is a simple example illustrating how to use Handle Graphics to build user interfaces. The statement

```
b = uicontrol('Style','pushbutton', ...  
            'Units','normalized', ...  
            'Position',[.5 .5 .2 .1], ...  
            'String','click here');
```

creates a pushbutton in the center of a figure window and returns a handle to the new object. But, so far, clicking on the button does nothing. The statement

```
s = 'set(b, 'Position',[.8*rand .9*rand .2 .1])';
```

creates a string containing a command that alters the pushbutton's position. Repeated execution of

```
eval(s)
```

moves the button to random positions. Finally,

```
set(b, 'Callback', s)
```

installs `s` as the button's callback action, so every time you click on the button, it moves to a new position.

### Graphical User Interface Design Tools

MATLAB provides GUI Design Environment (GUIDE) tools that simplify the creation of graphical user interfaces. To display the GUIDE Layout Editor, issue the `guide` command.

## Animations

MATLAB provides two ways of generating moving, animated graphics:

- Continually erase and then redraw the objects on the screen, making incremental changes with each redraw.
- Save a number of different pictures and then play them back as a movie.

### Erase Mode Method

Using the `EraseMode` property is appropriate for long sequences of simple plots where the change from frame to frame is minimal. Here is an example showing simulated Brownian motion. Specify a number of points, such as

```
n = 20
```

and a temperature or velocity, such as

```
s = .02
```

The best values for these two parameters depend upon the speed of your particular computer. Generate  $n$  random points with  $(x,y)$  coordinates between  $-1/2$  and  $+1/2$ .

```
x = rand(n,1)-0.5;  
y = rand(n,1)-0.5;
```

Plot the points in a square with sides at  $-1$  and  $+1$ . Save the handle for the vector of points and set its `EraseMode` to `xor`. This tells the MATLAB graphics system not to redraw the entire plot when the coordinates of one point are changed, but to restore the background color in the vicinity of the point using an “exclusive or” operation.

```
h = plot(x,y, '.');  
axis([-1 1 -1 1])  
axis square  
grid off  
set(h, 'EraseMode', 'xor', 'MarkerSize', 18)
```

Now begin the animation. Here is an infinite `while` loop, which you can eventually exit by typing **Ctrl+c**. Each time through the loop, add a small amount of normally distributed random noise to the coordinates of the points.

Then, instead of creating an entirely new plot, simply change the XData and YData properties of the original plot.

```
while 1
    drawnow
    x = x + s*randn(n,1);
    y = y + s*randn(n,1);
    set(h, 'XData',x, 'YData',y)
end
```

How long does it take for one of the points to get outside of the square? How long before all of the points are outside the square?

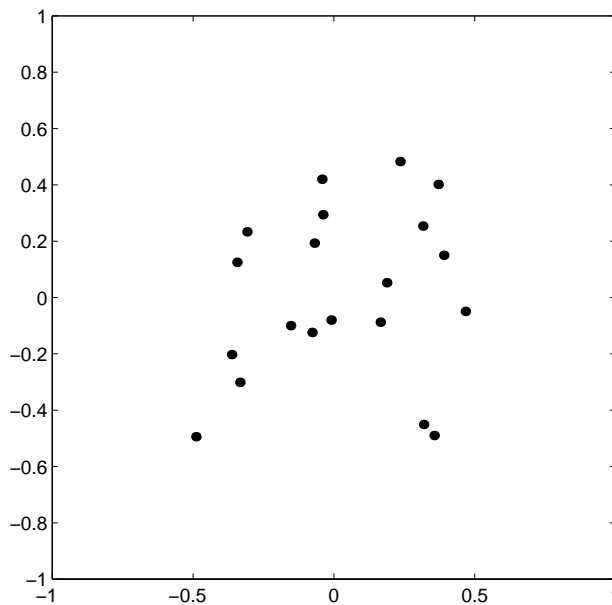

## Creating Movies

If you increase the number of points in the Brownian motion example to something like  $n = 300$  and  $s = .02$ , the motion is no longer very fluid; it takes too much time to draw each time step. It becomes more effective to save a predetermined number of frames as bitmaps and to play them back as a *movie*.

First, decide on the number of frames, say

```
nframes = 50;
```

Next, set up the first plot as before, except using the default EraseMode (normal).

```
x = rand(n,1)-0.5;  
y = rand(n,1)-0.5;  
h = plot(x,y, '.');  
set(h, 'MarkerSize', 18);  
axis([-1 1 -1 1])  
axis square  
grid off
```

Generate the movie and use getframe to capture each frame.

```
for k = 1:nframes  
    x = x + s*randn(n,1);  
    y = y + s*randn(n,1);  
    set(h, 'XData', x, 'YData', y)  
    M(k) = getframe;  
end
```

Finally, play the movie 30 times.

```
movie(M,30)
```



# Programming with MATLAB

---

<b>Flow Control . . . . .</b>	<b>5-2</b>
<b>Other Data Structures . . . . .</b>	<b>5-7</b>
<b>Scripts and Functions . . . . .</b>	<b>5-17</b>
<b>Demonstration Programs Included with MATLAB . . .</b>	<b>5-27</b>

## Flow Control

MATLAB has several flow control constructs:

- if statements
- switch statements
- for loops
- while loops
- continue statements
- break statements

### if

The `if` statement evaluates a logical expression and executes a group of statements when the expression is *true*. The optional `elseif` and `else` keywords provide for the execution of alternate groups of statements. An `end` keyword, which matches the `if`, terminates the last group of statements. The groups of statements are delineated by the four keywords – no braces or brackets are involved.

MATLAB's algorithm for generating a magic square of order  $n$  involves three different cases: when  $n$  is odd, when  $n$  is even but not divisible by 4, or when  $n$  is divisible by 4. This is described by

```
if rem(n,2) ~= 0
    M = odd_magic(n)
elseif rem(n,4) ~= 0
    M = single_even_magic(n)
else
    M = double_even_magic(n)
end
```

In this example, the three cases are mutually exclusive, but if they weren't, the first *true* condition would be executed.

It is important to understand how relational operators and `if` statements work with matrices. When you want to check for equality between two variables, you might use

```
if A == B, ...
```

This is legal MATLAB code, and does what you expect when A and B are scalars. But when A and B are matrices, `A == B` does not test *if* they are equal, it tests *where* they are equal; the result is another matrix of 0's and 1's showing element-by-element equality. In fact, if A and B are not the same size, then `A == B` is an error.

The proper way to check for equality between two variables is to use the `isequal` function,

```
if isequal(A,B), ...
```

Here is another example to emphasize this point. If A and B are scalars, the following program will never reach the unexpected situation. But for most pairs of matrices, including our magic squares with interchanged columns, none of the matrix conditions `A > B`, `A < B` or `A == B` is true for *all* elements and so the `else` clause is executed.

```
if A > B
    'greater'
elseif A < B
    'less'
elseif A == B
    'equal'
else
    error('Unexpected situation')
end
```

Several functions are helpful for reducing the results of matrix comparisons to scalar conditions for use with `if`, including

```
isequal
isempty
all
any
```

## switch and case

The `switch` statement executes groups of statements based on the value of a variable or expression. The keywords `case` and `otherwise` delineate the groups. Only the first matching case is executed. There must always be an `end` to match the `switch`.

The logic of the magic squares algorithm can also be described by

```
switch (rem(n,4)==0) + (rem(n,2)==0)
    case 0
        M = odd_magic(n)
    case 1
        M = single_even_magic(n)
    case 2
        M = double_even_magic(n)
    otherwise
        error('This is impossible')
end
```

---

**Note** Unlike the C language switch statement, MATLAB's switch does not fall through. If the first case statement is *true*, the other case statements do not execute. So, break statements are not required.

---

## for

The for loop repeats a group of statements a fixed, predetermined number of times. A matching end delineates the statements.

```
for n = 3:32
    r(n) = rank(magic(n));
end
r
```

The semicolon terminating the inner statement suppresses repeated printing, and the `r` after the loop displays the final result.

It is a good idea to indent the loops for readability, especially when they are nested.

```
for i = 1:m
    for j = 1:n
        H(i,j) = 1/(i+j);
    end
end
```

## while

The `while` loop repeats a group of statements an indefinite number of times under control of a logical condition. A matching `end` delineates the statements.

Here is a complete program, illustrating `while`, `if`, `else`, and `end`, that uses interval bisection to find a zero of a polynomial.

```
a = 0; fa = -Inf;
b = 3; fb = Inf;
while b-a > eps*b
    x = (a+b)/2;
    fx = x^3-2*x-5;
    if sign(fx) == sign(fa)
        a = x; fa = fx;
    else
        b = x; fb = fx;
    end
end
x
```

The result is a root of the polynomial  $x^3 - 2x - 5$ , namely

```
x =
    2.09455148154233
```

The cautions involving matrix comparisons that are discussed in the section on the `if` statement also apply to the `while` statement.

## continue

The `continue` statement passes control to the next iteration of the `for` or `while` loop in which it appears, skipping any remaining statements in the body of the loop. In nested loops, `continue` passes control to the next iteration of the `for` or `while` loop enclosing it.

The example below shows a `continue` loop that counts the lines of code in the file, `magic.m`, skipping all blank lines and comments. A `continue` statement is used to advance to the next line in `magic.m` without incrementing the count whenever a blank line or comment line is encountered.

```
fid = fopen('magic.m','r');
count = 0;
while ~feof(fid)
```

```
        line = fgetl(fid);
        if isempty(line) | strcmp(line,'% ',1)
            continue
        end
        count = count + 1;
    end
    disp(sprintf('%d lines',count));
```

## **break**

The `break` statement lets you exit early from a `for` or `while` loop. In nested loops, `break` exits from the innermost loop only.

Here is an improvement on the example from the previous section. Why is this use of `break` a good idea?

```
a = 0; fa = -Inf;
b = 3; fb = Inf;
while b-a > eps*b
    x = (a+b)/2;
    fx = x^3-2*x-5;
    if fx == 0
        break
    elseif sign(fx) == sign(fa)
        a = x; fa = fx;
    else
        b = x; fb = fx;
    end
end
x
```

## Other Data Structures

This section introduces you to some other data structures in MATLAB, including:

- Multidimensional arrays
- Cell arrays
- Characters and text
- Structures

### Multidimensional Arrays

Multidimensional arrays in MATLAB are arrays with more than two subscripts. They can be created by calling `zeros`, `ones`, `rand`, or `randn` with more than two arguments. For example,

```
R = randn(3,4,5);
```

creates a 3-by-4-by-5 array with a total of  $3 \times 4 \times 5 = 60$  normally distributed random elements.

A three-dimensional array might represent three-dimensional physical data, say the temperature in a room, sampled on a rectangular grid. Or, it might represent a sequence of matrices,  $A^{(k)}$ , or samples of a time-dependent matrix,  $A(t)$ . In these latter cases, the  $(i, j)$ th element of the  $k$ th matrix, or the  $t_k$ th matrix, is denoted by  $A(i, j, k)$ .

MATLAB's and Dürer's versions of the magic square of order 4 differ by an interchange of two columns. Many different magic squares can be generated by interchanging columns. The statement

```
p = perms(1:4);
```

generates the  $4! = 24$  permutations of  $1:4$ . The  $k$ th permutation is the row vector,  $p(k, :)$ . Then

```
A = magic(4);  
M = zeros(4,4,24);  
for k = 1:24  
    M(:, :, k) = A(:, p(k, :));  
end
```

stores the sequence of 24 magic squares in a three-dimensional array, M. The size of M is

```
size(M)

ans =
     4     4    24
```

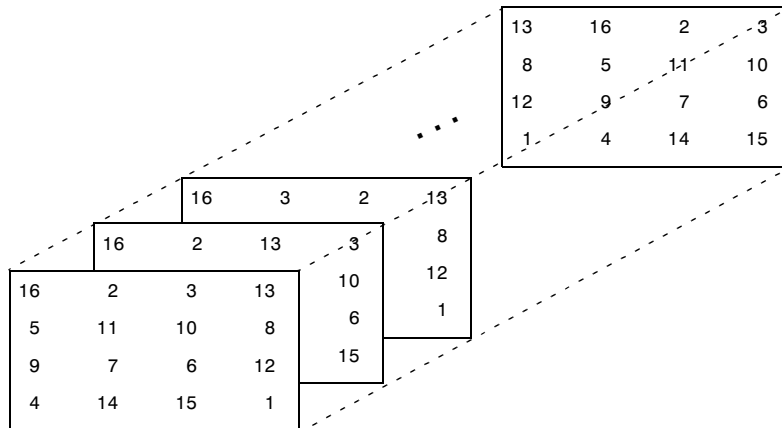

It turns out that the third matrix in the sequence is Dürer's.

```
M(:, :, 3)

ans =
    16     3     2    13
     5    10    11     8
     9     6     7    12
     4    15    14     1
```

The statement

```
sum(M, d)
```

computes sums by varying the dth subscript. So

```
sum(M, 1)
```

is a 1-by-4-by-24 array containing 24 copies of the row vector

```
34    34    34    34
```



and

```
sum(M,2)
```

is a 4-by-1-by-24 array containing 24 copies of the column vector

```
34
34
34
34
```

Finally,

```
S = sum(M,3)
```

adds the 24 matrices in the sequence. The result has size 4-by-4-by-1, so it looks like a 4-by-4 array.

```
S =
    204    204    204    204
    204    204    204    204
    204    204    204    204
    204    204    204    204
```

## Cell Arrays

Cell arrays in MATLAB are multidimensional arrays whose elements are copies of other arrays. A cell array of empty matrices can be created with the `cell` function. But, more often, cell arrays are created by enclosing a miscellaneous collection of things in curly braces, `{}`. The curly braces are also used with subscripts to access the contents of various cells. For example,

```
C = {A sum(A) prod(prod(A))}
```

produces a 1-by-3 cell array. The three cells contain the magic square, the row vector of column sums, and the product of all its elements. When `C` is displayed, you see

```
C =
    [4x4 double]    [1x4 double]    [20922789888000]
```

This is because the first two cells are too large to print in this limited space, but the third cell contains only a single number,  $16!$ , so there is room to print it.

Here are two important points to remember. First, to retrieve the contents of one of the cells, use subscripts in curly braces. For example, `C{1}` retrieves the magic square and `C{3}` is 16!. Second, cell arrays contain *copies* of other arrays, not *pointers* to those arrays. If you subsequently change A, nothing happens to C.

Three-dimensional arrays can be used to store a sequence of matrices of the *same* size. Cell arrays can be used to store a sequence of matrices of *different* sizes. For example,

```
M = cell(8,1);
for n = 1:8
    M{n} = magic(n);
end
M
```

produces a sequence of magic squares of different order.

```
M =
     [          1]
     [ 2x2  double]
     [ 3x3  double]
     [ 4x4  double]
     [ 5x5  double]
     [ 6x6  double]
     [ 7x7  double]
     [ 8x8  double]
```

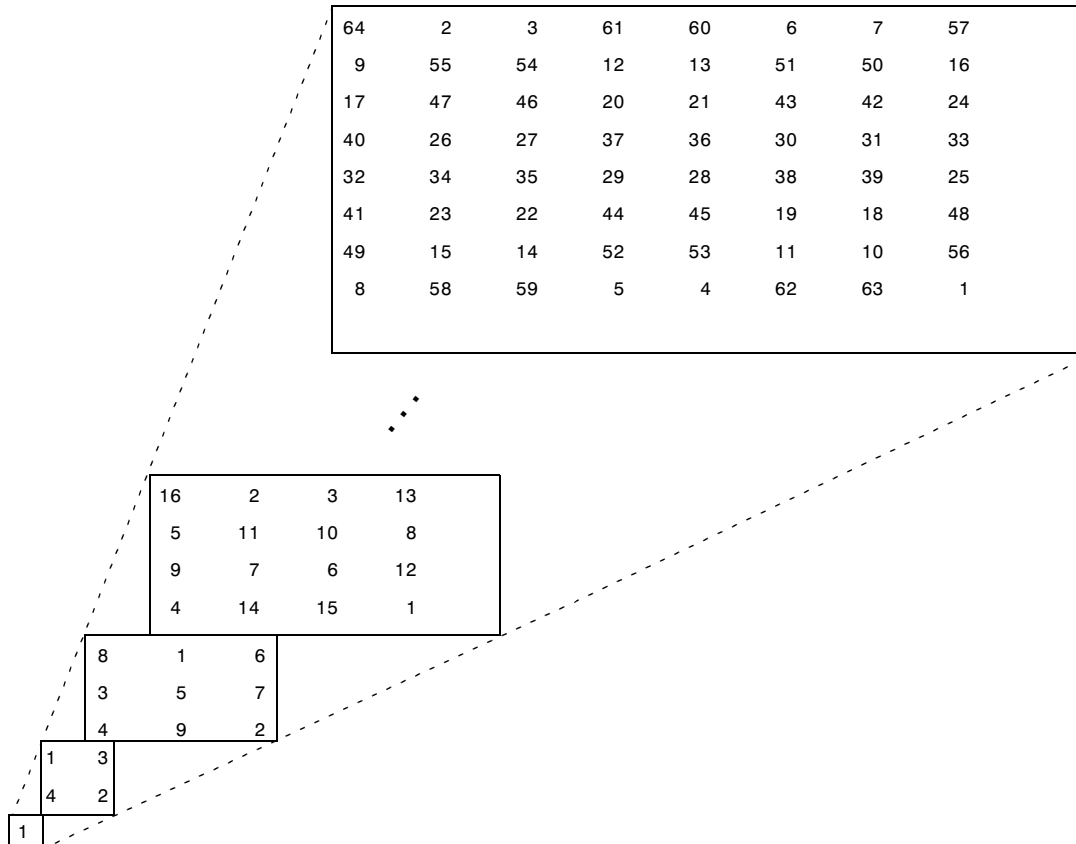

You can retrieve our old friend with

```
M{4}
```

## Characters and Text

Enter text into MATLAB using single quotes. For example,

```
s = 'Hello'
```

The result is not the same kind of numeric matrix or array we have been dealing with up to now. It is a 1-by-5 character array.

Internally, the characters are stored as numbers, but not in floating-point format. The statement

```
a = double(s)
```

converts the character array to a numeric matrix containing floating-point representations of the ASCII codes for each character. The result is

```
a =
    72    101    108    108    111
```

The statement

```
s = char(a)
```

reverses the conversion.

Converting numbers to characters makes it possible to investigate the various fonts available on your computer. The printable characters in the basic ASCII character set are represented by the integers 32:127. (The integers less than 32 represent nonprintable control characters.) These integers are arranged in an appropriate 6-by-16 array with

```
F = reshape(32:127,16,6)';
```

The printable characters in the extended ASCII character set are represented by F+128. When these integers are interpreted as characters, the result depends on the font currently being used. Type the statements

```
char(F)
char(F+128)
```

and then vary the font being used for the MATLAB Command Window. Select **Preferences** from the **File** menu. Be sure to try the **Symbol** and **Wingdings** fonts, if you have them on your computer. Here is one example of the kind of output you might obtain.

```
!"#$%&'()*+,-./
0123456789:;<=>?
@ABCDEFGHIJKLMNO
PQRSTUVWXYZ[\]^_
`abcdefghijklmnop
qrstuvwxyz{|}~-
†°£$•¶ß@©™´¨|ÆØ
```

```

x±ōŠ¥μ 1 2 3 1/2 a 0 3/4 æø
ł i - ð f Ÿ « » ... þ Å Ã Ö œ
-- " ' ' ÷ þ Ÿ € , , ? ?
‡ · , , % Â Ê Ä Ë Ì Í Î Ï Ó
š Ő Ū Ū Ū ^ ~ - ° „ ” Ÿ

```

Concatenation with square brackets joins text variables together into larger strings. The statement

```
h = [s, ' world']
```

joins the strings horizontally and produces

```
h =
  Hello world
```

The statement

```
v = [s; 'world']
```

joins the strings vertically and produces

```
v =
  Hello
  world
```

Note that a blank has to be inserted before the 'w' in h and that both words in v have to have the same length. The resulting arrays are both character arrays; h is 1-by-11 and v is 2-by-5.

To manipulate a body of text containing lines of different lengths, you have two choices – a padded character array or a cell array of strings. The char function accepts any number of lines, adds blanks to each line to make them all the same length, and forms a character array with each line in a separate row. For example,

```
S = char('A', 'rolling', 'stone', 'gathers', 'momentum.')
```

produces a 5-by-9 character array.

```
S =
  A
rolling
stone
gathers
momentum.
```

There are enough blanks in each of the first four rows of `S` to make all the rows the same length. Alternatively, you can store the text in a cell array. For example,

```
C = {'A'; 'rolling'; 'stone'; 'gathers'; 'momentum.'}
```

is a 5-by-1 cell array.

```
C =  
    'A'  
    'rolling'  
    'stone'  
    'gathers'  
    'momentum.'
```

You can convert a padded character array to a cell array of strings with

```
C = cellstr(S)
```

and reverse the process with

```
S = char(C)
```

## Structures

Structures are multidimensional MATLAB arrays with elements accessed by textual *field designators*. For example,

```
S.name = 'Ed Plum';  
S.score = 83;  
S.grade = 'B+'
```

creates a scalar structure with three fields.

```
S =  
    name: 'Ed Plum'  
    score: 83  
    grade: 'B+'
```

Like everything else in MATLAB, structures are arrays, so you can insert additional elements. In this case, each element of the array is a structure with several fields. The fields can be added one at a time,

```
S(2).name = 'Toni Miller';
S(2).score = 91;
S(2).grade = 'A-';
```

or, an entire element can be added with a single statement.

```
S(3) = struct('name','Jerry Garcia',...
             'score',70,'grade','C')
```

Now the structure is large enough that only a summary is printed.

```
S =
1x3 struct array with fields:
    name
    score
    grade
```

There are several ways to reassemble the various fields into other MATLAB arrays. They are all based on the notation of a *comma separated list*. If you type

```
S.score
```

it is the same as typing

```
S(1).score, S(2).score, S(3).score
```

This is a comma separated list. Without any other punctuation, it is not very useful. It assigns the three scores, one at a time, to the default variable `ans` and dutifully prints out the result of each assignment. But when you enclose the expression in square brackets,

```
[S.score]
```

it is the same as

```
[S(1).score, S(2).score, S(3).score]
```

which produces a numeric row vector containing all of the scores.

```
ans =
    83    91    70
```

Similarly, typing

```
S.name
```

just assigns the names, one at time, to ans. But enclosing the expression in curly braces,

```
{S.name}
```

creates a 1-by-3 cell array containing the three names.

```
ans =  
    'Ed Plum'    'Toni Miller'    'Jerry Garcia'
```

And

```
char(S.name)
```

calls the char function with three arguments to create a character array from the name fields,

```
ans =  
Ed Plum  
Toni Miller  
Jerry Garcia
```



## Scripts and Functions

MATLAB is a powerful programming language as well as an interactive computational environment. Files that contain code in the MATLAB language are called M-files. You create M-files using a text editor, then use them as you would any other MATLAB function or command.

There are two kinds of M-files:

- Scripts, which do not accept input arguments or return output arguments. They operate on data in the workspace.
- Functions, which can accept input arguments and return output arguments. Internal variables are local to the function.

If you're a new MATLAB programmer, just create the M-files that you want to try out in the current directory. As you develop more of your own M-files, you will want to organize them into other directories and personal toolboxes that you can add to MATLAB's search path.

If you duplicate function names, MATLAB executes the one that occurs first in the search path.

To view the contents of an M-file, for example, `myfunction.m`, use

```
type myfunction
```

### Scripts

When you invoke a *script*, MATLAB simply executes the commands found in the file. Scripts can operate on existing data in the workspace, or they can create new data on which to operate. Although scripts do not return output arguments, any variables that they create remain in the workspace, to be used in subsequent computations. In addition, scripts can produce graphical output using functions like `plot`.

For example, create a file called `magicrank.m` that contains these MATLAB commands.

```
% Investigate the rank of magic squares
r = zeros(1,32);
for n = 3:32
    r(n) = rank(magic(n));
end
```

```
r  
bar(r)
```

### Typing the statement

```
magicrank
```

causes MATLAB to execute the commands, compute the rank of the first 30 magic squares, and plot a bar graph of the result. After execution of the file is complete, the variables `n` and `r` remain in the workspace.

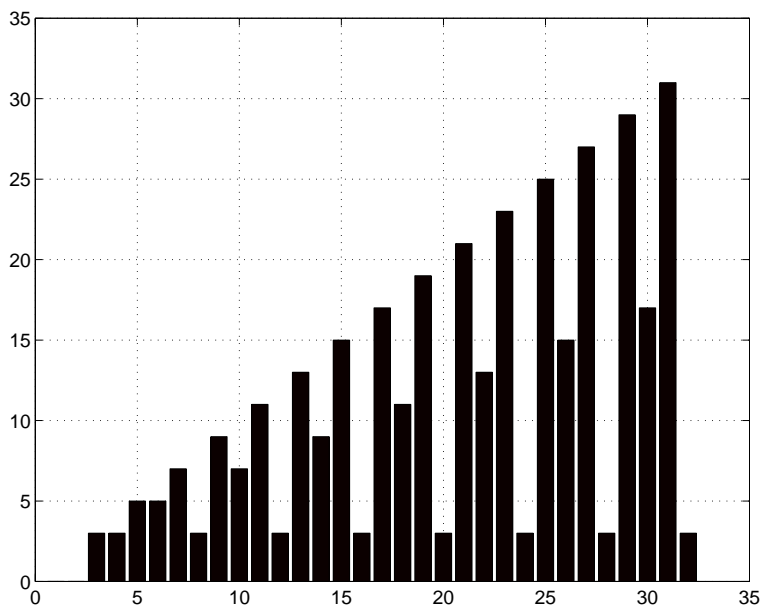

## Functions

Functions are M-files that can accept input arguments and return output arguments. The name of the M-file and of the function should be the same. Functions operate on variables within their own workspace, separate from the workspace you access at the MATLAB command prompt.

A good example is provided by `rank`. The M-file `rank.m` is available in the directory

```
toolbox/matlab/matfun
```

You can see the file with

```
type rank
```

Here is the file.

```
function r = rank(A,tol)
% RANK Matrix rank.
% RANK(A) provides an estimate of the number of linearly
% independent rows or columns of a matrix A.
% RANK(A,tol) is the number of singular values of A
% that are larger than tol.
% RANK(A) uses the default tol = max(size(A)) * norm(A) * eps.

s = svd(A);
if nargin==1
    tol = max(size(A)') * max(s) * eps;
end
r = sum(s > tol);
```

The first line of a function M-file starts with the keyword `function`. It gives the function name and order of arguments. In this case, there are up to two input arguments and one output argument.

The next several lines, up to the first blank or executable line, are comment lines that provide the help text. These lines are printed when you type

```
help rank
```

The first line of the help text is the H1 line, which MATLAB displays when you use the `lookfor` command or request help on a directory.

The rest of the file is the executable MATLAB code defining the function. The variable `s` introduced in the body of the function, as well as the variables on the first line, `r`, `A` and `tol`, are all *local* to the function; they are separate from any variables in the MATLAB workspace.

This example illustrates one aspect of MATLAB functions that is not ordinarily found in other programming languages – a variable number of arguments. The rank function can be used in several different ways.

```
rank(A)
r = rank(A)
r = rank(A,1.e-6)
```

Many M-files work this way. If no output argument is supplied, the result is stored in `ans`. If the second input argument is not supplied, the function computes a default value. Within the body of the function, two quantities named `nargin` and `nargout` are available which tell you the number of input and output arguments involved in each particular use of the function. The rank function uses `nargin`, but does not need to use `nargout`.

## Global Variables

If you want more than one function to share a single copy of a variable, simply declare the variable as `global` in all the functions. Do the same thing at the command line if you want the base workspace to access the variable. The global declaration must occur before the variable is actually used in a function. Although it is not required, using capital letters for the names of global variables helps distinguish them from other variables. For example, create an M-file called `falling.m`.

```
function h = falling(t)
global GRAVITY
h = 1/2*GRAVITY*t.^2;
```

Then interactively enter the statements

```
global GRAVITY
GRAVITY = 32;
y = falling((0:.1:5)');
```

The two global statements make the value assigned to `GRAVITY` at the command prompt available inside the function. You can then modify `GRAVITY` interactively and obtain new solutions without editing any files.

## Passing String Arguments to Functions

You can write MATLAB functions that accept string arguments without the parentheses and quotes. That is, MATLAB interprets

```
foo a b c
```

as

```
foo('a', 'b', 'c')
```

However, when using the unquoted form, MATLAB cannot return output arguments. For example,

```
legend apples oranges
```

creates a legend on a plot using the strings `apples` and `oranges` as labels. If you want the `legend` command to return its output arguments, then you must use the quoted form.

```
[leg,h,objh] = legend('apples','oranges');
```

In addition, you cannot use the unquoted form if any of the arguments are not strings.

### Constructing String Arguments in Code

The quoted form enables you to construct string arguments within the code. The following example processes multiple data files, `August1.dat`, `August2.dat`, and so on. It uses the function `int2str`, which converts an integer to a character, to build the filename.

```
for d = 1:31
    s = ['August' int2str(d) '.dat'];
    load(s)
    % Code to process the contents of the d-th file
end
```

### A Cautionary Note

While the unquoted syntax is convenient, it can be used incorrectly without causing MATLAB to generate an error. For example, given a matrix `A`,

```
A =
     0     -6     -1
     6      2    -16
    -5     20    -10
```

The `eig` command returns the eigenvalues of `A`.

```
eig(A)
ans =
   -3.0710
  -2.4645+17.6008i
  -2.4645-17.6008i
```

The following statement is not allowed because A is not a string, however MATLAB does not generate an error.

```
eig A
ans =
    65
```

MATLAB actually takes the eigenvalues of ASCII numeric equivalent of the letter A (which is the number 65).

## The eval Function

The eval function works with text variables to implement a powerful text macro facility. The expression or statement

```
eval(s)
```

uses the MATLAB interpreter to evaluate the expression or execute the statement contained in the text string s.

The example of the previous section could also be done with the following code, although this would be somewhat less efficient because it involves the full interpreter, not just a function call.

```
for d = 1:31
    s = ['load August' int2str(d) '.dat'];
    eval(s)
    % Process the contents of the d-th file
end
```

## Vectorization

To obtain the most speed out of MATLAB, it's important to vectorize the algorithms in your M-files. Where other programming languages might use for or DO loops, MATLAB can use vector or matrix operations. A simple example involves creating a table of logarithms.

```
x = .01;
for k = 1:1001
    y(k) = log10(x);
    x = x + .01;
end
```

A vectorized version of the same code is

```
x = .01:.01:10;  
y = log10(x);
```

For more complicated code, vectorization options are not always so obvious. When speed is important, however, you should always look for ways to vectorize your algorithms.

## Preallocation

If you can't vectorize a piece of code, you can make your for loops go faster by preallocating any vectors or arrays in which output results are stored. For example, this code uses the function `zeros` to preallocate the vector created in the for loop. This makes the for loop execute significantly faster.

```
r = zeros(32,1);  
for n = 1:32  
    r(n) = rank(magic(n));  
end
```

Without the preallocation in the previous example, the MATLAB interpreter enlarges the `r` vector by one element each time through the loop. Vector preallocation eliminates this step and results in faster execution.

## Function Handles

You can create a handle to any MATLAB function and then use that handle as a means of referencing the function. A function handle is typically passed in an argument list to other functions, which can then execute, or *evaluate*, the function using the handle.

Construct a function handle in MATLAB using the *at* sign, `@`, before the function name. The following example creates a function handle for the `sin` function and assigns it to the variable `fhandle`.

```
fhandle = @sin;
```

Evaluate a function handle using the MATLAB `feval` function. The function `plot_fhandle`, shown below, receives a function handle and data, and then performs an evaluation of the function handle on that data using `feval`.

```
function x = plot_fhandle(fhandle, data)  
plot(data, feval(fhandle, data))
```

When you call `plot_fhandle` with a handle to the `sin` function and the argument shown below, the resulting evaluation produces a sine wave plot.

```
plot_fhandle(@sin, -pi:0.01:pi)
```

## Function Functions

A class of functions, called “function functions,” works with nonlinear functions of a scalar variable. That is, one function works on another function. The function functions include:

- Zero finding
- Optimization
- Quadrature
- Ordinary differential equations

MATLAB represents the nonlinear function by a function M-file. For example, here is a simplified version of the function `humps` from the `matlab/demos` directory.

```
function y = humps(x)
y = 1./((x-.3).^2 + .01) + 1./((x-.9).^2 + .04) - 6;
```

Evaluate this function at a set of points in the interval  $0 \leq x \leq 1$  with

```
x = 0:.002:1;
y = humps(x);
```

Then plot the function with

```
plot(x,y)
```



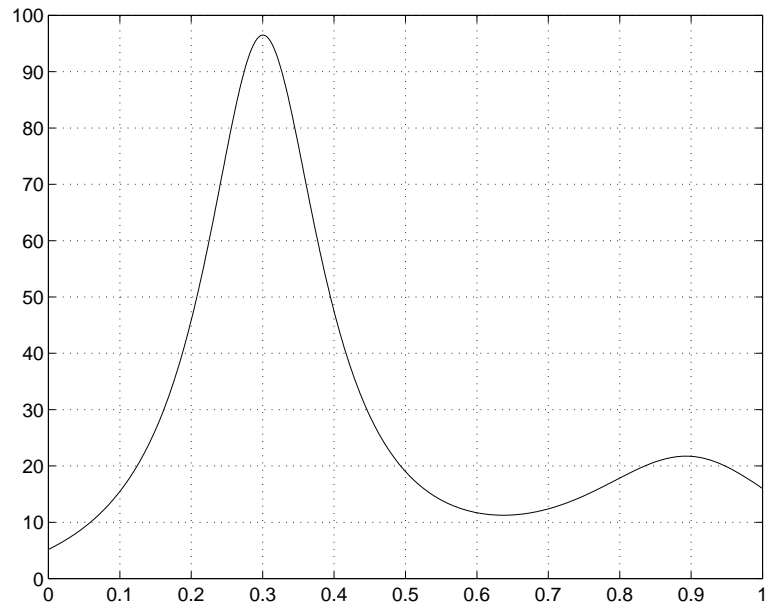

The graph shows that the function has a local minimum near  $x = 0.6$ . The function `fminsearch` finds the *minimizer*, the value of  $x$  where the function takes on this minimum. The first argument to `fminsearch` is a function handle to the function being minimized and the second argument is a rough guess at the location of the minimum.

```
p = fminsearch(@humps, .5)
p =
    0.6370
```

To evaluate the function at the minimizer,

```
humps(p)
ans =
    11.2528
```

Numerical analysts use the terms *quadrature* and *integration* to distinguish between numerical approximation of definite integrals and numerical

integration of ordinary differential equations. MATLAB's quadrature routines are `quad` and `quadl`. The statement

```
Q = quadl(@humps,0,1)
```

computes the area under the curve in the graph and produces

```
Q =  
29.8583
```

Finally, the graph shows that the function is never zero on this interval. So, if you search for a zero with

```
z = fzero(@humps,.5)
```

you will find one outside of the interval

```
z =  
-0.1316
```

## Demonstration Programs Included with MATLAB

MATLAB includes many demonstration programs that highlight various features and functions. For a complete list of the demos, at the command prompt type

```
help demos
```

To view a specific file, for example, `airfoil`, type

```
edit airfoil
```

To run a demonstration, type the filename at the command prompt. For example, to run the `airfoil` demonstration, type

```
airfoil
```

---

**Note** Many of the demonstrations use multiple windows and require you to press a key in the MATLAB Command Window to continue through the demonstration.

---

The following tables list some of the current demonstration programs that are available, organized into these categories:

- Matrix demos
- Numeric demos
- Visualization demos
- Language demos
- ODE suite demos
- Gallery demos
- Game demos
- Miscellaneous demos
- Helper function demos

**MATLAB Matrix Demonstration Programs**

airfoil	Graphical demonstration of sparse matrix from NASA airfoil.
buckydem	Connectivity graph of the Buckminster Fuller geodesic dome.
delsqdemo	Finite difference Laplacian on various domains.
eigmovie	Symmetric eigenvalue movie.
eigshow	Graphical demonstration of matrix eigenvalues.
intro	Introduction to basic matrix operations in MATLAB.
inverter	Demonstration of the inversion of a large matrix.
matmanip	Introduction to matrix manipulation.
rrefmovie	Computation of reduced row echelon form.
sepdemo	Separators for a finite element mesh.
sparsity	Demonstration of the effect of sparsity orderings.
svdshow	Graphical demonstration of matrix singular values.

**MATLAB Numeric Demonstration Programs**

bench	MATLAB benchmark.
census	Prediction of the U.S. population in the year 2000.
e2pi	Two-dimensional, visual solution to the problem "Which is greater, $e^\pi$ or $\pi^e$ ?"
fftdemo	Use of the FFT function for spectral analysis.
fitdemo	Nonlinear curve fit with simplex algorithm.
fplotdemo	Demonstration of plotting a function.

**MATLAB Numeric Demonstration Programs (Continued)**

funfuncs	Demonstration of functions operating on other functions.
lotkadem	Example of ordinary differential equation solution.
quaddemo	Adaptive quadrature.
quake	Loma Prieta earthquake.
spline2d	Demonstration of ginput and spline in two dimensions.
sunspots	Demonstration of the fast Fourier transform (FFT) function in MATLAB used to analyze the variations in sunspot activity.
zerodemo	Zero finding with fzero.

**MATLAB Visualization Demonstration Programs**

colormenu	Demonstration of adding a colormap to the current figure.
cplxdemo	Maps of functions of a complex variable.
earthmap	Graphical demonstrations of earth's topography.
graf2d	Two-dimensional XY plots in MATLAB.
graf2d2	Three-dimensional XYZ plots in MATLAB.
grafcplx	Demonstration of complex function plots in MATLAB.
imagedemo	Demonstration of MATLAB's image capability.
imageext	Demonstration of changing and rotating image colormaps.
lorenz	Graphical demonstration of the orbit around the Lorenz chaotic attractor.

**MATLAB Visualization Demonstration Programs (Continued)**

penny	Several views of the penny data.
vibes	Vibrating L-shaped membrane movie.
xfourier	Graphical demonstration of Fourier series expansion.
xpklein	Klein bottle demo.
xpsound	Demonstration of MATLAB's sound capability.

**MATLAB Language Demonstration Programs**

graf3d	Demonstration of Handle Graphics for surface plots.
hndlaxis	Demonstration of Handle Graphics for axes.
hndlgraf	Demonstration of Handle Graphics for line plots.
xplang	Introduction to the MATLAB language.

**MATLAB ODE Suite Demonstration Programs**

a2ode	Stiff problem, linear with real eigenvalues.
a3ode	Stiff problem, linear with real eigenvalues.
b5ode	Stiff problem, linear with complex eigenvalues.
ballode	Equations of motion for a bouncing ball used by BALLDEMO.
besslode	Bessel's equation of order 0 used by BESSLDEMO.
brussode	Stiff problem, modelling a chemical reaction (Brusselator).
buiode	Stiff problem, analytical solution due to Bui.
chm6ode	Stiff problem CHM6 from Enright and Hull.

**MATLAB ODE Suite Demonstration Programs (Continued)**

chm7ode	Stiff problem CHM7 from Enright and Hull.
chm9ode	Stiff problem CHM9 from Enright and Hull.
d1ode	Stiff problem, nonlinear with real eigenvalues.
fem1ode	Stiff problem with a time-dependent mass matrix.
fem2ode	Stiff problem with a time-independent mass matrix.
gearode	Stiff problem due to Gear as quoted by van der Houwen.
hb1ode	Stiff problem 1 of Hindmarsh and Byrne.
hb2ode	Stiff problem 2 of Hindmarsh and Byrne.
hb3ode	Stiff problem 3 of Hindmarsh and Byrne.
odedemo	Demonstration of the ODE suite integrators.
orbitode	Restricted 3 body problem used by ORBITDEMO.
orbt2ode	Nonstiff problem D5 of Hull et al.
rigidode	Euler equations of a rigid body without external forces.
sticode	Spring-driven mass stuck to surface, used by STICDEMO.
vdpode	Parameterizable van der Pol equation (stiff for large $\mu$ ).

**MATLAB Gallery Demonstration Programs**

cruller	Graphical demonstration of a cruller.
klein1	Graphical demonstration of a Klein bottle.
knot	Tube surrounding a three-dimensional knot.
logo	Graphical demonstration of the MATLAB L-shaped membrane logo.

**MATLAB Gallery Demonstration Programs (Continued)**

modes	Graphical demonstration of 12 modes of the L-shaped membrane.
quivdemo	Graphical demonstration of the quiver function.
spharm2	Graphical demonstration of spherical surface harmonic.
tori4	Graphical demonstration of four-linked, unknotted tori.
finddemo	Command that finds available demos for individual toolboxes.
helpfun	Utility function for displaying help text conveniently.
membrane	The MathWorks logo.
peaks	Sample function of two variables.
pltmat	Command that displays a matrix in a figure window.

**MATLAB Game Demonstration Programs**

bblwrap	Bubblewrap.
life	Conway's Game of Life.
soma	Soma cube.
xpbombs	Minesweeper game.

**MATLAB Miscellaneous Demonstration Programs**

codec	Alphabet transposition coder/decoder.
crulspin	Spinning cruller movie.
logospin	Movie of the MathWorks logo spinning.



**MATLAB Miscellaneous Demonstration Programs (Continued)**

makevase	Demonstration of a surface of revolution.
quatdemo	Quaternion rotation.
spinner	Colorful lines spinning through space.
travel	Traveling salesman problem.
truss	Animation of a bending bridge truss.
wrldtrv	Great circle flight routes around the globe.
xphide	Visual perception of objects in motion.
xpquad	Superquadrics plotting demonstration.

**MATLAB Helper Functions Demonstration Programs**

bucky	Graph of the Buckminster Fuller geodesic dome.
cmdlnbgn	Set up for command line demos.
cmdlnend	Clean up after command line demos.
cmdlnwin	Demo gateway routine for running command line demos.
finddemo	Command that finds available demos for individual toolboxes.
helpfun	Utility function for displaying help text conveniently.
membrane	The MathWorks logo.
peaks	Sample function of two variables.
pltmat	Command that displays a matrix in a figure window.

### Getting More Information

The MathWorks Web site ([www.mathworks.com](http://www.mathworks.com)) contains numerous M-files that have been written by users and MathWorks staff. These are accessible by selecting **Downloads**. Also, **Technical Notes**, which is accessible from our Technical Support Web site ([www.mathworks.com/support](http://www.mathworks.com/support)), contains numerous examples on graphics, mathematics, API, Simulink, and others.

## Symbols

: operator 3-7

## A

algorithms

vectorizing 5-22

animation 4-34

annotating plots 4-14

ans 3-4

Application Program Interface (API) 1-3

Array Editor 2-13

array operators 3-22

arrays 3-18, 3-21

cell 5-9

character 5-11

columnwise organization 3-24

concatenating 3-16

creating in M-files 3-15

deleting rows and columns 3-17

deleting rows or columns 3-17

elements 3-10

generating with functions and operators 3-14

listing contents 3-10

loading from external data files 3-15

multidimensional 5-7

notation for elements 3-10

preallocating 5-23

structure 5-14

variable names 3-10

aspect ratio of axes 4-11

axes 4-10

axis

labels 4-12

titles 4-12

axis 4-10

## B

bookmarking documentation 2-10

break 5-6

## C

case 5-3

cell arrays 5-9

char 5-13

character arrays 5-11

characteristic polynomial 3-21

colon operator 3-7

colormap 4-20

colors

lines for plotting 4-4

Command History 2-7

command line editing 3-30

Command Window 2-6

complex numbers, plotting 4-6

concatenating

arrays 3-16

strings 5-13

concatenation 3-16

configuring the desktop 2-5

constants

special 3-12

contents in Help browser 2-10

continue 5-5

continuing statements on multiple lines 3-30

current directory 2-11

Current Directory browser 2-11

## D

debugging M-files 2-14

deleting array elements 3-17

- demonstration programs 5-27
- demos 5-27
- demos, running from the Launch Pad 2-8
- desktop for MATLAB 2-4
- desktop tools 2-6
- determinant of matrix 3-19
- development environment 2-2
- diag 3-5
- display pane in Help browser 2-10
- documentation 2-8

## E

- editing command lines 3-30
- editing plots
  - interactively 4-15
- Editor/Debugger 2-14
- eigenvalue 3-20
- eigenvector 3-20
- elements of arrays 3-10
- entering matrices 3-3
- environment 2-2
- erase mode 4-34
- eval 5-22
- executing MATLAB 2-3
- exiting MATLAB 2-3
- exporting data 2-15
- expressions 3-10, 3-13
  - evaluating 5-22
- external programs, running from MATLAB 2-7

## F

- favorites in Help browser 2-10
- figure 4-8
- figure windows 4-8
  - with multiple plots 4-9

- find 3-27
- finding in a page 2-10
- finding object handles 4-31
- flip1r 3-5
- floating-point numbers 3-11
- flow control 5-2
- for 5-4
- format
  - of output display 3-28
- format 3-28
- function 5-19
- function functions 5-24
- function handles
  - defined 5-23
  - using 5-25
- function M-file 5-17, 5-18
- function of two variables 4-18
- functions 3-11, 5-18
  - built-in 3-12
  - variable number of arguments 5-19

## G

- global variables 5-20
- graphical user interface 4-33
- graphics
  - 2-D 4-2
  - files 4-24
  - handle graphics 4-26
  - objects 4-26
  - printing 4-24
- grids 4-12

## H

- Handle Graphics 1-3, 4-26
  - finding handles 4-31

Help browser 2-8  
help functions 2-10  
Help Navigator 2-10  
hierarchy of graphics objects 4-27  
hold 4-7

**I**

if 5-2  
images 4-22  
imaginary number 3-10  
Import Wizard 2-15  
importing data 2-15  
index in Help browser 2-10

**L**

Launch Pad 2-8  
legend 4-3  
legend, adding to plot 4-3  
library  
    mathematical function 1-3  
lighting 4-20  
limits, axes 4-10  
line continuation 3-30  
line styles of plots 4-4  
load 3-15  
loading arrays 3-15  
local variables 5-19  
log of functions used 2-7  
logical vectors 3-26

**M**

magic 3-8  
magic square 3-4  
markers 4-5

MAT-file 4-22  
mathematical function library 1-3  
mathematical functions  
    listing advanced 3-11  
    listing elementary 3-11  
    listing matrix 3-11

**MATLAB**

    Application Program Interface 1-3  
    history 1-2  
    language 1-3  
    mathematical function library 1-3  
    overview 1-2  
matrices 3-18  
    creating 3-14  
    entering 3-3  
matrix 3-2  
    antidiagonal 3-5  
    determinant 3-19  
    main diagonal 3-5  
    singular 3-19  
    swapping columns 3-8  
    symmetric 3-18  
    transpose 3-4  
matrix multiplication 3-18  
mesh plot 4-18  
M-file 1-2, 3-15, 5-17  
    creating 5-17  
    for creating arrays 3-15  
    function 5-17, 5-18  
    script 5-17  
M-file performance 2-15  
M-files 2-14  
Microsoft Word and access to MATLAB 2-15  
movies 4-35  
multidimensional arrays 5-7  
multiple data sets, plotting 4-3  
multiple plots per figure 4-9

multivariate data, organizing 3-24

## N

newsgroup for MATLAB users 2-10

Notebook 2-15

numbers 3-10

floating-point 3-11

## O

object properties 4-28

objects

finding handles 4-31

graphics 4-26

online help, viewing 2-8

operator 3-11

colon 3-7

output

controlling format 3-28

suppressing 3-30

overlying plots 4-7

## P

path 2-12

performance of M-files 2-15

plot 4-2

plot editing mode

overview 4-15

plots

editing 4-14

plotting

adding legend 4-3

adding plots 4-7

annotating 4-14

basic 4-2

complex data 4-6

complex numbers 4-6

contours 4-7

line colors 4-4

line styles 4-4

lines and markers 4-5

mesh and surface 4-18

multiple data sets 4-3

multiple plots 4-9

PostScript 4-24

preallocation 5-23

preferences 2-5

print 4-24

printing

graphics 4-24

profiler 2-15

Property Editor

interface 4-16

## Q

quitting MATLAB 2-3

## R

revision control systems, interfacing to MATLAB  
2-15

running functions 2-6

running MATLAB 2-3

**S**

- scalar expansion 3-25
- scientific notation 3-10
- script M-file 5-17
- scripts 5-17
- search path 2-12
- searching documentation 2-10
- semicolon to suppress output 3-30
- shutting down MATLAB 2-3
- singular matrix 3-19
- source control systems, interfacing to MATLAB 2-15
- special constants 3-12
  - infinity 3-12
  - not-a-number 3-12
- starting MATLAB 2-3
- statements
  - continuing on multiple lines 3-30
  - executing 5-22
- strings
  - concatenating 5-13
- structures 5-14
- subplot 4-9
- subscripting
  - with logical vectors 3-26
- subscripts 3-6
- sum 3-4
- suppressing output 3-30
- surface plot 4-18
- switch 5-3
- symmetric matrix 3-18

**T**

- text 5-11
- TIFF 4-25

**title**

- figure 4-12
- toolbox 1-2
- tools in the desktop 2-6
- transpose 3-4

**U**

- user interface 4-33
  - building 4-33

**V**

- variables 3-10
  - global 5-20
  - local 5-19
- vector 3-2
  - logical 3-26
  - preallocating 5-23
- vectorization 5-22
- version control systems, interfacing to MATLAB 2-15
- viewing documentation 2-10
- visibility of axes 4-11

**W**

- while 5-5
- windows for plotting 4-8
- windows in MATLAB 2-4
- wireframe 4-18
  - surface 4-18
- Word and access to MATLAB 2-15
- word processing access to MATLAB 2-15
- workspace 2-12
- Workspace browser 2-12

**X**

xor erase mode 4-34