

MATLAB[®]

The Language of Technical Computing

- Computation
- Visualization
- Programming

Using MATLAB[®] Graphics

Version 7



How to Contact The MathWorks:



www.mathworks.com	Web
comp.soft-sys.matlab	Newsgroup



support@mathworks.com	Technical support
suggest@mathworks.com	Product enhancement suggestions
bugs@mathworks.com	Bug reports
doc@mathworks.com	Documentation error reports
service@mathworks.com	Order status, license renewals, passcodes
info@mathworks.com	Sales, pricing, and general information



508-647-7000	Phone
--------------	-------



508-647-7001	Fax
--------------	-----



The MathWorks, Inc. 3 Apple Hill Drive Natick, MA 01760-2098	Mail
--	------

For contact information about worldwide offices, see the MathWorks Web site.

Using MATLAB Graphics

© COPYRIGHT 1984 - 2004 by The MathWorks, Inc.

The software described in this document is furnished under a license agreement. The software may be used or copied only under the terms of the license agreement. No part of this manual may be photocopied or reproduced in any form without prior written consent from The MathWorks, Inc.

FEDERAL ACQUISITION: This provision applies to all acquisitions of the Program and Documentation by, for, or through the federal government of the United States. By accepting delivery of the Program or Documentation, the government hereby agrees that this software or documentation qualifies as commercial computer software or commercial computer software documentation as such terms are used or defined in FAR 12.212, DFARS Part 227.72, and DFARS 252.227-7014. Accordingly, the terms and conditions of this Agreement and only those rights specified in this Agreement, shall pertain to and govern the use, modification, reproduction, release, performance, display, and disclosure of the Program and Documentation by the federal government (or other entity acquiring for or through the federal government) and shall supersede any conflicting contractual terms or conditions. If this License fails to meet the government's needs or is inconsistent in any respect with federal procurement law, the government agrees to return the Program and Documentation, unused, to The MathWorks, Inc.

MATLAB, Simulink, Stateflow, Handle Graphics, and Real-Time Workshop are registered trademarks, and TargetBox is a trademark of The MathWorks, Inc.

Other product or brand names are trademarks or registered trademarks of their respective holders.

Printing History:	January 1997	First printing	New for MATLAB 5.1
	January 1998	Second printing	Revised for MATLAB 5.2
	January 1999	Third printing	Revised for MATLAB 5.3 (Release 11)
	September 2000	Fourth printing	Revised for MATLAB 6.0 (Release 12)
	June 2001	Online only	Revised for MATLAB 6.1 (Release 12.1)
	July 2002	Online only	Revised for MATLAB 6.5 (Release 13)
	June 2004	Fifth printing	Revised for MATLAB 7.0 (Release 14)

Graphics

MATLAB Plotting Tools

1

Anatomy of a Graph	1-2
Figure ToolBars	1-2
Plotting Tools — Interactive Plotting	1-4
Starting the Plotting Tools	1-4
Plotting Tools Interface Overview	1-4
The Figure Palette	1-7
The Plot Browser	1-11
The Property Editor	1-15
Accessing All Object Properties — Property Inspector	1-16
Example — Working with Plotting Tools	1-18
Adding a Subplot	1-20
Example — Plotting Workspace Variables	1-25
Plotting Expressions	1-27
Example — Specifying a Data Source	1-30
Creating the Graph	1-30
Varying the Data Source	1-30
Data Sources for Multiobject Graphs	1-32
Example — Generating M-Code to Reproduce a Graph ..	1-34
Data Arguments	1-35
Limitations	1-35
Editing Plots	1-36
Interactive Plot Editing	1-36

Using Functions to Edit Graphs	1-36
Using Plot Edit Mode	1-37
Starting Plot Edit Mode	1-38
Exiting Plot Edit Mode	1-38
Selecting Objects in a Graph	1-38
Cutting, Copying, and Pasting Objects	1-39
Moving and Resizing Objects	1-39
Setting Object Properties	1-40
Undo/Redo — Eliminating Mistakes	1-40
Saving Your Work	1-42
Saving a Graph in MAT-File Format	1-42
Saving to a Different Format — Exporting Figures	1-43
Printing Figures	1-44
Generating an M-File to Recreate a Graph	1-44

Data Exploration Tools

2

Ways to Explore Graphical Data	2-2
Types of Tools	2-2
Data Cursor — Displaying Data Values Interactively	2-3
Enabling Data Cursor Mode	2-3
Display Style — Datatip or Cursor Window	2-7
Selection Style — Select Data Points or	
Interpolate Points on Graph	2-8
Exporting Data Value to Workspace Variable	2-9
Zooming in 2-D and 3-D	2-11
Zooming in 2-D Views	2-11
Panning — Moving Your View of the Graph	2-14
2-D vs. 3-D Panning	2-14
Rotate 3D — Interactive Rotation of 3-D Views	2-15

Enabling Rotate 3D	2-15
Selecting Predefined Views	2-15
Rotation Style for Complex Graphs	2-15
Undo/Redo — Eliminating Mistakes	2-17
Analyzing Graphical Data	2-18
Basic Curve Fitting	2-18
Adding Plots of Basic Statistics to Graphs	2-20
Examples	2-21
Example — Plotting the Mean of a Data Set	2-21
Formatting Plots of Data Statistics	2-23
Statistics Plotted by the Data Statistics Tool	2-24
Viewing Statistics for Multiple Plots	2-25
Saving Statistics to the MATLAB Workspace	2-26

Annotating Graphs

3

How to Annotate Graphs	3-2
Graph Annotation Features	3-2
Enclosing Regions of a Graph in a Rectangle or an Ellipse	3-5
Textbox Annotations	3-7
Annotation Lines and Arrows	3-9
Adding a Colorbar to a Graph	3-13
Adding a Legend to a Graph	3-15
Pinning — Attaching to a Point in the Figure	3-16
Alignment Tool — Aligning and Distributing Objects	3-19
Example — Vertical Distribute, Horizontal Align	3-20
Align/Distribute Menu Options	3-22
Snap to Grid — Aligning Objects on a Grid	3-24
Adding Titles to Graphs	3-26
Using the Title Option on the Insert Menu	3-27
Using the Property Editor to Add a Title	3-27
Using the title Function	3-28

Adding Axis Labels to Graphs	3-29
Using the Label Options on the Insert Menu	3-30
Using the Property Editor to Add Axis Labels	3-30
Using Axis-Label Commands	3-32
Adding Text Annotations to Graphs	3-35
Creating Text Annotations with the text or gtext Command .	3-36
Text Alignment	3-39
Example — Aligning Text	3-40
Editing Text Objects	3-41
Mathematical Symbols, Greek Letters, and TEX Characters .	3-42
Using Character and Numeric Variables in Text	3-44
Example — Multiline Text	3-45
Drawing Text in a Box	3-46
Adding Arrows and Lines to Graphs	3-48
Creating Arrows and Lines in Plot Editing Mode	3-48
Editing Arrows and Line Annotations	3-49

Basic Plotting Commands

4

Basic Plotting Commands	4-2
Plotting Steps	4-2
Creating Line Plots	4-3
Specifying Line Style	4-5
Specifying the Color and Size of Lines	4-7
Adding Plots to an Existing Graph	4-8
Plotting Only the Data Points	4-9
Plotting Markers and Lines	4-10
Line Styles for Black and White Output	4-11
Setting Default Line Styles	4-12
Line Plots of Matrix Data	4-14
Plotting Imaginary and Complex Data	4-16

Plotting with Two Y-Axes	4-17
Combining Linear and Logarithmic Axes	4-17
Setting Axis Parameters	4-20
Axis Limits and Ticks	4-20
Example — Specifying Ticks and Tick Labels	4-23
Setting Aspect Ratio	4-24
Figure Windows	4-27
Displaying Multiple Plots per Figure	4-27
Specifying the Target Axes	4-29
Default Color Scheme	4-29

Creating Specialized Plots

5

Bar and Area Graphs	5-2
Types of Bar Graphs	5-2
Stacked Bar Graphs to Show Contributing Amounts	5-5
Specifying X-Axis Data	5-7
Overlaying Plots on Bar Graphs	5-9
Area Graphs	5-11
Comparing Data Sets with Area Graphs	5-12
Pie Charts	5-14
Removing a Piece from a Pie Chart	5-16
Histograms	5-17
Histograms in Cartesian Coordinate Systems	5-17
Histograms in Polar Coordinates	5-19
Specifying Number of Bins	5-20
Discrete Data Graphs	5-22
Two-Dimensional Stem Plots	5-22
Combining Stem Plots with Line Plots	5-25
Three-Dimensional Stem Plots	5-26
Stairstep Plots	5-29

Direction and Velocity Vector Graphs	5-31
Compass Plots	5-31
Feather Plots	5-32
Two-Dimensional Quiver Plots	5-34
Three-Dimensional Quiver Plots	5-35
Contour Plots	5-37
Creating Simple Contour Plots	5-37
Labeling Contours	5-39
Filled Contours	5-40
Drawing a Single Contour Line at a Desired Level	5-41
The Contouring Algorithm	5-42
Changing the Offset of a Contour	5-43
Displaying Contours in Polar Coordinates	5-44
Interactive Plotting	5-48
Animation	5-50
Movies	5-50
Example — Visualizing an FFT as a Movie	5-51
Erase Modes	5-52

Displaying Bit-Mapped Images

6

Overview	6-2
Images in MATLAB	6-4
Bit Depth Support	6-4
Data Types	6-4
Image Types	6-6
Indexed Images	6-6
Intensity Images	6-7
RGB (Truecolor) Images	6-9
Working with 8-Bit and 16-Bit Images	6-11

8-Bit and 16-Bit Indexed Images	6-11
8-Bit and 16-Bit Intensity Images	6-12
8-Bit and 16-Bit RGB Images	6-12
Mathematical Operations Support for uint8 and uint16	6-13
Other 8-Bit and 16-Bit Array Support	6-13
Converting an 8-Bit RGB Image to Grayscale	6-14
Summary of Image Types and Numeric Classes	6-16
Reading, Writing, and Querying Graphics Image Files ...	6-17
Reading a Graphics Image	6-17
Writing a Graphics Image	6-18
Obtaining Information About Graphics Files	6-18
Displaying Graphics Images	6-20
Summary of Image Types and Display Methods	6-21
Controlling Aspect Ratio and Display Size	6-21
The Image Object and Its Properties	6-25
Image CData	6-25
Image CDataMapping	6-25
XData and YData	6-26
EraseMode	6-28
Printing Images	6-30
Converting the Data or Graphic Type of Images	6-31

Printing and Exporting

7

Overview of Printing and Exporting	7-2
Print and Export Operations	7-2
Graphical User Interfaces	7-2
Command Line Interface	7-3
Specifying Parameters and Options	7-5
Default Settings and How to Change Them	7-6

How to Print or Export	7-9
Using Print Preview	7-9
Printing a Figure	7-11
Printing to a File	7-15
Exporting to a File	7-17
Exporting to the Windows Clipboard	7-27
Examples of Basic Operations	7-30
Printing a Figure at Screen Size	7-30
Printing with a Specific Paper Size	7-31
Printing a Centered Figure	7-32
Exporting in a Specific Graphics Format	7-33
Exporting in EPS Format with a TIFF Preview	7-34
Exporting a Figure to the Clipboard	7-35
Changing a Figure's Settings	7-38
Selecting the Figure	7-40
Selecting the Printer	7-40
Setting the Figure Size and Position	7-41
Setting the Paper Size or Type	7-45
Setting the Paper Orientation	7-46
Selecting a Renderer	7-48
Setting the Resolution	7-51
Setting the Axes Ticks and Limits	7-54
Setting the Background Color	7-56
Setting Line and Text Characteristics	7-57
Setting the Line and Text Color	7-59
Setting CMYK Color	7-61
Excluding User Interface Controls	7-62
Producing Uncropped Figures	7-62
Choosing a Graphics Format	7-64
Frequently Used Graphics Formats	7-65
Factors to Consider in Choosing a Format	7-66
Properties Affected by Choice of Format	7-68
Impact of Rendering Method on the Output	7-70
Description of Selected Graphics Formats	7-70
How to Specify a Format for Exporting	7-74
Choosing a Printer Driver	7-75

Types of Printer Drivers	7-75
Factors to Consider in Choosing a Driver	7-76
Driver-Specific Information	7-79
How to Specify the Printer Driver to Use	7-83
Troubleshooting	7-85
Printing Problems	7-86
Exporting Problems	7-89
General Problems	7-92

Handle Graphics Objects

8

Organization of Graphics Objects	8-3
Types of Graphics Objects	8-4
Information on Specific Graphics Objects	8-4
Graphics Windows — the Figure	8-5
Figures Used for Graphing Data	8-6
Figures Used for GUIs	8-6
Root Object — the Figure Parent	8-7
More Information on Figures	8-7
Core Graphics Objects	8-8
Description of Core Graphics Objects	8-11
Example — Creating Core Graphics Objects	8-12
Parenting	8-14
High-Level Versus Low-Level	8-14
Simplified Calling Syntax	8-15
Plot Objects	8-17
Creating a Plot Object	8-18
Identifying Plot Objects Programmatically	8-19
Linking Graphs to Variables — Data Source Properties	8-19
Plot Objects and Backward Compatibility	8-20

Annotation Objects	8-22
Annotation Object Properties	8-22
Example — Enclosing Subplots with an Annotation Rectangle	8-22
Group Objects	8-25
Creating a Group	8-25
Transforming Objects	8-26
Example — Transforming a Hierarchy of Objects	8-31
Object Properties	8-35
Storing Object Information	8-35
Changing Values	8-35
Default Values	8-35
Properties Common to All Objects	8-36
Setting and Querying Property Values	8-38
Setting Property Values	8-38
Querying Property Values	8-40
Factory-Defined Property Values	8-42
Setting Default Property Values	8-43
How MATLAB Searches for Default Values	8-43
Defining Default Values	8-45
Examples — Setting Default Line Styles	8-46
Accessing Object Handles	8-50
The Current Figure, Axes, and Object	8-50
Searching for Objects by Property Values — findobj	8-52
Copying Objects	8-56
Deleting Objects	8-58
Controlling Graphics Output	8-60
Specifying the Target for Graphics Output	8-60
Preparing Figures and Axes for Graphics	8-60
Targeting Graphics Output with newplot	8-62
Example — Using newplot	8-63
Testing for Hold State	8-65
Protecting Figures and Axes	8-66
The Figure Close Request Function	8-68

Handle Validity Versus Handle Visibility	8-69
Saving Handles in M-Files	8-71
Properties Changed by Built-In Functions	8-72
Objects That Can Contain Other Objects	8-75
Using Panel Containers in Figures — UIPanels	8-75
Example — Using Figure Panels	8-76
Grouping Objects Within Axes — hgtransform	8-80
Callback Properties for Graphics Objects	8-84
Graphics Object Callbacks	8-84
User Interface Object Callbacks	8-84
Figure Callbacks	8-84
Function Handle Callbacks	8-86
Function Handle Syntax	8-86
Why Use Function Handle Callbacks	8-88
Example — Using Function Handles in GUIs	8-90
Complete Example Code	8-90
The GUI Layout	8-90
Initialize the GUI	8-91
The Callback Functions	8-92

Figure Properties

9

Figure Objects	9-2
Related Information About Figures	9-2
Docking Figures in the Desktop	9-3
Figure Properties That Affect Docking	9-4
Creating a Nondockable Figure	9-4
Positioning Figures	9-5

The Position Vector	9-5
Example — Specifying Figure Position	9-7
Figure Colormaps — The Colormap Property	9-9
Specifying the Figure Colormap	9-9
Selecting Drawing Methods	9-10
Backing Store	9-10
Double Buffering	9-10
Selecting a Renderer	9-11
Specifying the Figure Pointer	9-13
Defining Custom Pointers	9-14

Axes Properties

10

Axes Objects — Defining Coordinate Systems for Graphs	10-2
Labeling and Appearance Properties	10-3
Creating Axes with Specific Characteristics	10-3
Positioning Axes	10-5
The Position Vector	10-5
Position Units	10-6
Automatic Axes Resize	10-7
Multiple Axes per Figure	10-13
Placing Text Outside the Axes	10-13
Multiple Axes for Different Scaling	10-14
Individual Axis Control	10-16
Setting Axis Limits	10-17
Setting Tick Mark Locations	10-18
Changing Axis Direction	10-19

Using Multiple X- and Y-Axes	10-22
Example — Double Axis Graphs	10-22
Automatic-Mode Properties	10-25
Colors Controlled by Axes	10-28
Specifying Axes Colors	10-28
Axes Color Limits — the CLim Property	10-30
Example — Simulating Multiple Colormaps in a Figure ...	10-31
Calculating Color Limits	10-32
Defining the Color of Lines for Plotting	10-35
Line Styles Used for Plotting — LineStyleOrder	10-37

3-D Visualization

Creating 3-D Graphs

11

A Typical 3-D Graph	11-2
Line Plots of 3-D Data	11-3
Representing a Matrix as a Surface	11-5
Mesh and Surface Plots	11-5
Visualizing Functions of Two Variables	11-6
Surface Plots of Nonuniformly Sampled Data	11-8
Parametric Surfaces	11-10
Hidden Line Removal	11-12
Coloring Mesh and Surface Plots	11-13
Coloring Techniques	11-13
Types of Color Data	11-13
Colormaps	11-14
Indexed Color Surfaces — Direct and Scaled Colormapping	11-16
Example — Mapping Surface Curvature to Color	11-17

Altering Colormaps	11-19
Truecolor Surfaces	11-20
Texture Mapping	11-22

Defining the View

12

Viewing Overview	12-2
Positioning the Viewpoint	12-2
Setting the Aspect Ratio	12-2
Default Views	12-3
Setting the Viewpoint with Azimuth and Elevation	12-4
Azimuth and Elevation	12-4
Defining Scenes with Camera Graphics	12-8
View Control with the Camera Toolbar	12-9
Camera Toolbar	12-9
Camera Motion Controls	12-12
Orbit Camera	12-12
Orbit Scene Light	12-13
Pan/Tilt Camera	12-14
Move Camera Horizontally/Vertically	12-15
Move Camera Forward and Backward	12-15
Zoom Camera	12-17
Camera Roll	12-18
Camera Graphics Functions	12-19
Example — Dollying the Camera	12-20
Example — Moving the Camera Through a Scene	12-22
Summary of Techniques	12-22
Graphing the Volume Data	12-22
Setting Up the View	12-23
Specifying the Light Source	12-23

Selecting a Renderer	12-24
Defining the Camera Path as a Stream Line	12-24
Implementing the Fly-Through	12-24
Low-Level Camera Properties	12-28
Default Viewpoint Selection	12-29
Moving In and Out on the Scene	12-29
Making the Scene Larger or Smaller	12-31
Revolving Around the Scene	12-31
Rotation Without Resizing of Graphics Objects	12-31
Rotation About the Viewing Axis	12-32
View Projection Types	12-34
Projection Types and Camera Location	12-35
Understanding Axes Aspect Ratio	12-39
Stretch-to-Fill	12-39
Specifying Axis Scaling	12-39
Specifying Aspect Ratio	12-40
Example — axis Command Options	12-41
Additional Commands for Setting Aspect Ratio	12-43
Axes Aspect Ratio Properties	12-44
Default Aspect Ratio Selection	12-45
Overriding Stretch-to-Fill	12-47
Effects of Setting Aspect Ratio Properties	12-48
Example — Displaying Real Objects	12-52

Lighting as a Visualization Tool

13

Lighting Overview	13-2
Lighting Examples	13-2
Lighting Commands	13-3
Light Objects	13-4

Adding Lights to a Scene	13-5
Properties That Affect Lighting	13-8
Selecting a Lighting Method	13-10
Face and Edge Lighting Methods	13-10
Reflectance Characteristics of Graphics Objects	13-11
Specular and Diffuse Reflection	13-11
Ambient Light	13-12
Specular Exponent	13-13
Specular Color Reflectance	13-14
Back Face Lighting	13-14
Positioning Lights in Data Space	13-17

Transparency

14

Making Objects Transparent	14-2
Specifying Transparency	14-3
Specifying a Single Transparency Value	14-5
Example — Transparent Isosurface	14-5
Mapping Data to Transparency — Alpha Data	14-7
Size of the Alpha Data Array	14-8
Mapping Alpha Data to the Alphamap	14-8
Example — Mapping Data to Color or Transparency	14-8
Selecting an Alphamap	14-10
Example — Modifying the Alphamap	14-12

Creating 3-D Models with Patches

15

Introduction to Patch Objects	15-2
Defining Patches	15-2
Behavior of the patch Function	15-2
Creating a Single Polygon	15-4
Multifaceted Patches	15-6
Example — Defining a Cube	15-6
Specifying Patch Coloring	15-11
Patch Color Properties	15-11
Patch Edge Coloring	15-13
Example — Specifying Flat Edge and Face Coloring	15-13
Coloring Edges with Shared Vertices	15-14
Interpreting Indexed and Truecolor Data	15-16
Indexed Color Data	15-16
Truecolor Patches	15-19
Interpolating in Indexed Color Versus Truecolor	15-19

Volume Visualization Techniques

16

Overview of Volume Visualization	16-3
Examples of Volume Data	16-3
Selecting Visualization Techniques	16-3
Steps to Create a Volume Visualization	16-4
Volume Visualization Functions	16-5
Functions for Scalar Data	16-5
Functions for Vector Data	16-6
Visualizing Scalar Volume Data	16-7
Techniques for Visualizing Scalar Data	16-7

Visualizing MRI Data	16-8
Example — Ways to Display MRI Data	16-8
Exploring Volumes with Slice Planes	16-14
Example — Slicing Fluid Flow Data	16-14
Modifying the Color Mapping	16-17
Connecting Equal Values with Isosurfaces	16-19
Example — Isosurfaces in Fluid Flow Data	16-19
Isocaps Add Context to Visualizations	16-21
Defining Isocaps	16-22
Example — Adding Isocaps to an Isosurface	16-23
Visualizing Vector Volume Data	16-26
Using Scalar Techniques with Vector Data	16-26
Specifying Starting Points for Stream Plots	16-27
Accessing Subregions of Volume Data	16-30
Stream Line Plots of Vector Data	16-32
Displaying Curl with Stream Ribbons	16-34
Displaying Divergence with Stream Tubes	16-36
Creating Stream Particle Animations	16-39
Vector Field Displayed with Cone Plots	16-42

Index

Graphics

This section discusses techniques for plotting data and provides examples showing how to plot, annotate, and print graphs.

MATLAB Plotting Tools	Creating plots and setting graphic object properties
Data Exploration Tools	Tools to extract information from graphs interactively
Annotating Graphs	Adding annotations, axis labels, titles, and legends to graphs
Basic Plotting Commands	Plotting vector and matrix data in 2-D representations
Creating Specialized Plots	Creating bar graphs, histograms, contour plots, and other specialized plots
Displaying Bit-Mapped Images	Displaying and modifying bit-mapped images with MATLAB
Printing and Exporting	Printing graphs on paper and exporting graphs to standard graphic file formats
Handle Graphics Objects	MATLAB graphics objects and properties
Figure Properties	How to use figure properties
Axes Properties	How to use axes properties

Related Information

These other sections provide additional information about plotting.

3-D Visualization	Using viewing and lighting techniques to achieve complex graphic effects
Creating Graphical User Interfaces	How to include menus, push buttons, text boxes, and other user interface objects in MATLAB applications

MATLAB Plotting Tools

Anatomy of a Graph (p. 1-2)	Describes the basic components of a MATLAB® graph
Plotting Tools — Interactive Plotting (p. 1-4)	Introduces the interactive tools you can use for creating graphs and setting properties
Example — Working with Plotting Tools (p. 1-18)	Shows how to work with the Plotting Tools
Example — Plotting Workspace Variables (p. 1-25)	Access workspace variables from the Plotting Tools
Example — Specifying a Data Source (p. 1-30)	Link graph data to workspace variables
Example — Generating M-Code to Reproduce a Graph (p. 1-34)	Save all the property settings and other steps used to create a graph
Editing Plots (p. 1-36)	Overview of plot editing options.
Using Plot Edit Mode (p. 1-37)	Modify graph appearance interactively
Saving Your Work (p. 1-42)	Ways to save graphs

Anatomy of a Graph

MATLAB[®] plotting functions and tools direct their output to a window that is separate from the Command Window. In MATLAB this window is referred to as a *figure*. For example, the following picture illustrates a graph of the Bessel function, highlighting the basic components of the graph.

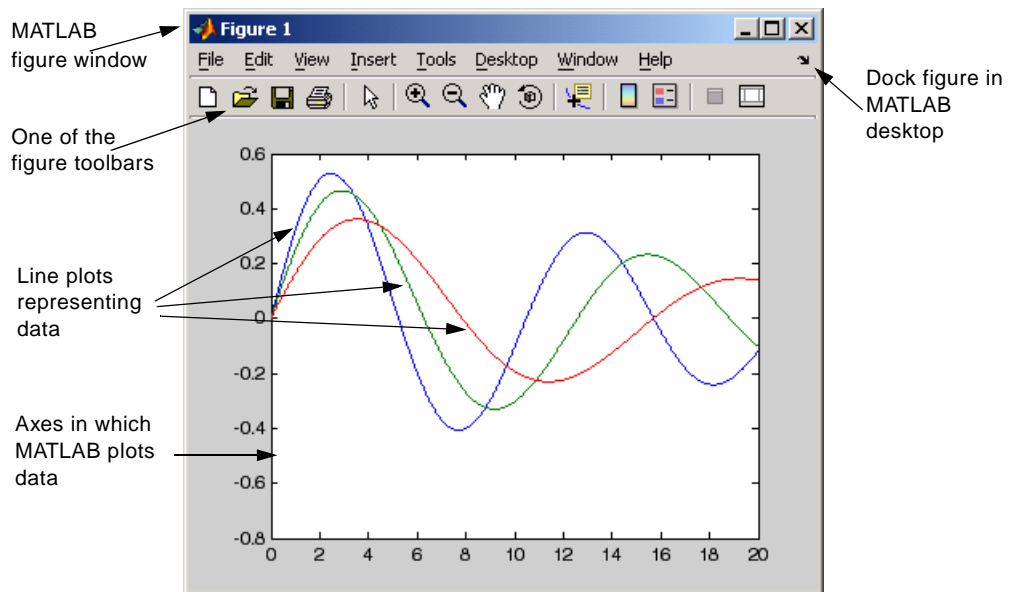

By default, MATLAB uses line style and color to distinguish the data sets plotted in the graph. However, you can change the appearance of these graphic components or add annotations to the graph to help explain your data for presentation.

Figure ToolBars

The figure's default toolbar provides shortcuts to commonly used features. The following picture shows the features available from this toolbar.

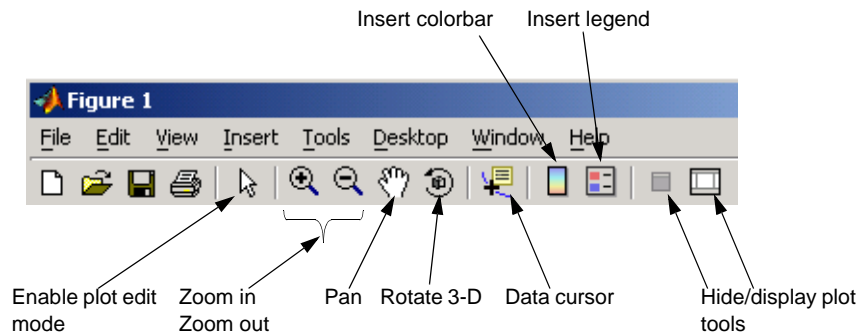

Note that you can enable two other toolbars from the **View** menu:

- Camera Toolbar — Use for manipulating 3-D views. See “View Control with the Camera Toolbar” for more information.
- Plot Edit Toolbar — Use for annotation and setting object properties. See “Annotation Tools on the Plot Edit Toolbar” on page 3-2 for more information.

Plotting Tools – Interactive Plotting

MATLAB provides a collection of plotting tools that form an interactive plotting environment. This environment enables you to

- Create various type of graphs
- Select variables to plot directly from a workspace browser
- Easily create and manipulate subplots in the figure
- Add annotations such as arrows, lines, and text
- Set properties on graphics objects

Starting the Plotting Tools

To create a figure with the plotting tools attached, use the `plottools` command. You can also start the plotting tools from the figure toolbar by clicking the Show Plot Tools icon .

Remove the plotting tools from a figure using the Hide Plot Tools icon .

You can display the three basic plotting tools from the **View** menu by selecting **Figure Palette**, **Plot Browser**, or **Property Editor**.

The next section describes the individual components making up the plotting tools.

Plotting Tools Interface Overview

The Plotting Tools interface includes three panels that are associated with a figure.

- **Figure Palette** — Use to create and arrange subplot axes, view and plot workspace variables, and add annotations. Display the Figure Palette using the `figurepalette` command.
- **Plot Browser** — Use to select and control the visibility of the axes or graphic objects plotted in the figure. You can also add data to any selected axes by clicking the **Add Data** button. Display the Plot Browser using the `plotbrowser` command.
- **Property Editor** — Use to set common properties of the selected object. You can also click the **Inspector** button to display the Property Inspector,

which provides access to all object properties. Display the Property Editor using the `propertyeditor` command.

Plotting Tools

This picture shows the plotting tools attached to a figure that contains two subplots.

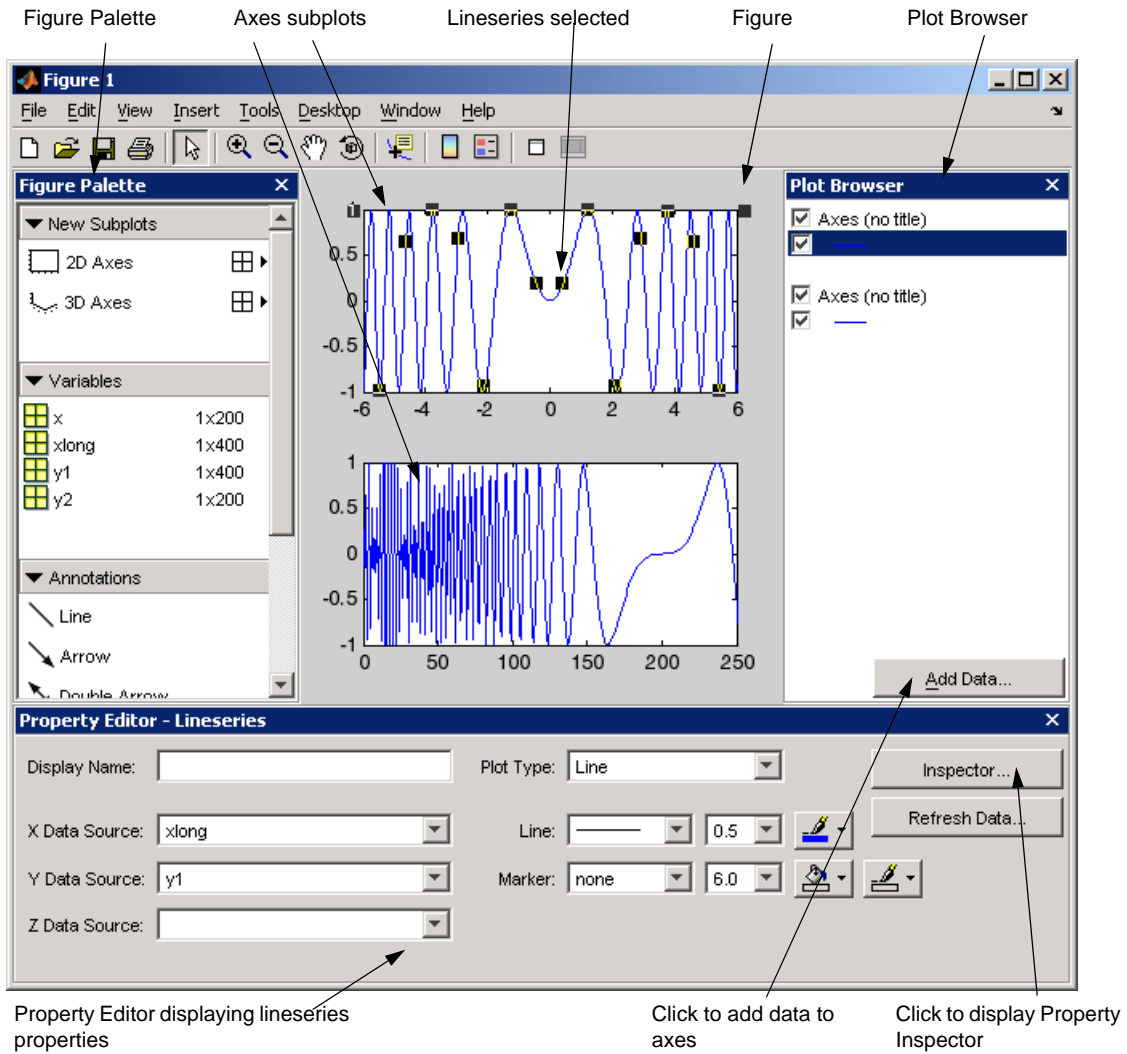

The Figure Palette

The Figure Palette contains three panels. Select the panel you want to view by clicking the respective button, which twists down the panel and exposes its contents.

The Figure Palette enables you to perform the following tasks with these panels:

- **New Subplots** — Add 2-D or 3-D axes to the figure.
- **Variables** — Browse and plot workspace variables.
- **Annotations** — Add annotations to graphs.

Adding Subplot Axes

The **New Subplots** panel enables you to create a grid of either 2-D or 3-D axes. To display the selector, click the grid icon next to the axes type. MATLAB displays the selector grid.

As you move the cursor, squares darken to indicate the layout of axes that will be created if you release the mouse button. Click **Cancel** at the bottom of the grid to leave the figure unchanged.

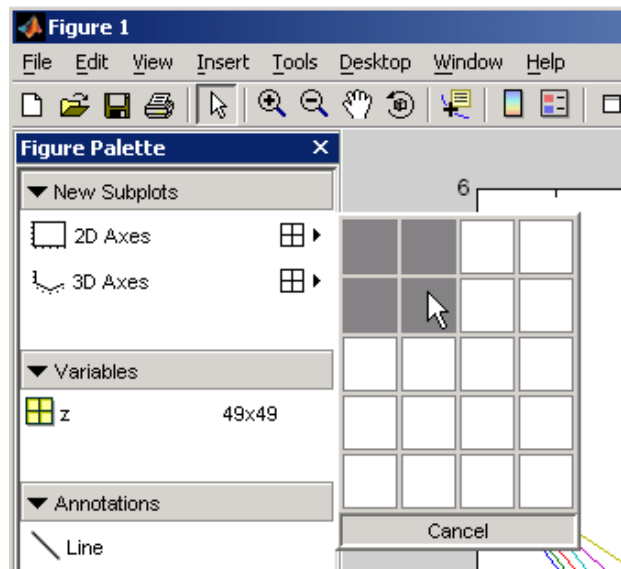

The picture above shows the **New Subplots** panel selected to display four equally sized axes in the figure. Existing axes resize as required to accommodate the new layout.

Plotting Workspace Variables

The **Variables** panel displays current workspace variables. Double-clicking a variable in this panel opens that variable in the Array Editor. If you select a variable and right-click to display the context menu, you can select a graphics function to plot the variable.

For example, the following picture illustrates how to plot the columns of variable Z. This is equivalent to passing a matrix to the plot function.

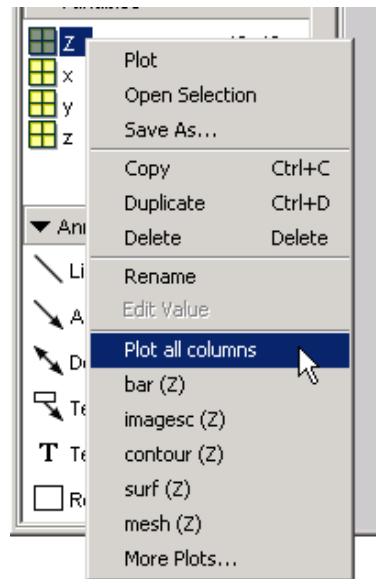

The context menu contains a list of possible plot types based on the variable you select and also enables you to perform certain operation on the variable, such as opening it in the Array Editor, saving, copying, and so on.

Note that the context menu items may change when you select different variables because a particular variable might be incompatible some of the plot types.

Drag and Drop Plotting

You can also drag the variable directly into an axes, in which case MATLAB selects the first appropriate plot type for that variable. If there are multiple axes, you must first select the one you want to plot in and then drag the variable to that axes.

In the previous example, the variable Z would be plotted using the `plot` function if you were to drag it into an axes.

If the desired plotting function is not available from the context menu, you can select **More Plots** to display the Plot Catalog tool.

The Plot Catalog Tool

The Plot Catalog tool provides access to most of the MATLAB plotting functions. You can type any workspace variables in the **Plotted Variables** field, which are then passed to the selected plotting function as arguments. Separate variables with a comma.

You can also enter a MATLAB expression using any workspace variables shown in the Figure Palette.

The following picture shows the Plot Catalog tool and describes its components.

Comma-separated list of variables or expressions is passed to selected function.

Help provides information on function arguments and links to more information.

Select a category of plotting functions.

Select a plotting function from the category.

Plot in the current figure or a new figure.

Plot Catalog

Plotted Variables:

Categories

- Line Plots
- Stem and Stair Plots
- Bar Plots
- Scatter Plots**
- Pie Charts
- Histograms
- Polar Plots
- Contour Plots
- Images
- 3D Surfaces
- Volumetrics
- Vector Fields
- Analytic Plots

Plot Types

- scatter**
- scatter3
- spy
- plotmatrix

Description

2-D Scatter Graph

Display markers at x - and y -coordinates specified in two variables

Plotted Variables

- Two variables -- plot circular markers at x - and y -coordinates specified in variables. Must be equal-sized vectors.
- Three variables -- third argument specifies area of each marker (points^2). Must be scalar or vector same size as coordinate arguments.
- Four variables -- fourth argument specifies marker colors. Can be scalar [ColorSpec](#), a vector the same size as coordinate arguments, or an n -by-3 array of RGB values, where n is the same length as coordinate arguments

Plot Plot in New Figure Close

Adding Annotations to Graphs

The **Annotations** panel enables you to insert annotation objects into a plot. To add an object, first select the object you want to add, and then click and drag the mouse to position and size the object.

See “How to Annotate Graphs” on page 3-2 for more information about the various types of annotation objects.

The Plot Browser

The Plot Browser provides a legend of all the graphs in the figure. It lists each axes and the objects (lines, surfaces, etc.) used to create the graph.

For example, suppose you plot an 11-by-11 matrix z . The `plot` function creates one line for each column in z .

```
plot(z, 'DisplayName', 'z')
```

When you set the `DisplayName` property, the Plot Browser indicates which line corresponds to which column.

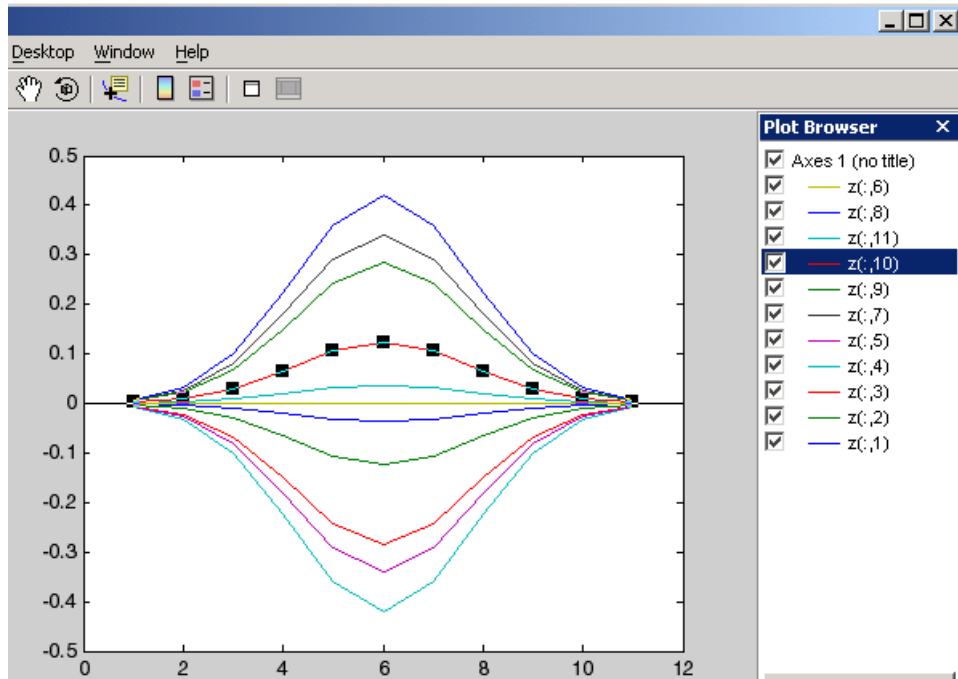

If you want to set the properties of an individual line, double-click on the line in the Plot Browser. Its properties are displayed in the Property Editor, which opens on the bottom of the figure.

You can select a line in the graph, and the corresponding entry in the Plot Browser is highlighted, enabling you to see which column in the variable produced the line.

Controlling Object Visibility

The check box next to each item in the Plot Browser controls the object's visibility. For example, suppose you want to plot only certain columns of data in z , perhaps the positive values. You can uncheck the columns you do not want to display. The graph updates as you uncheck each box and rescales the axes as required.

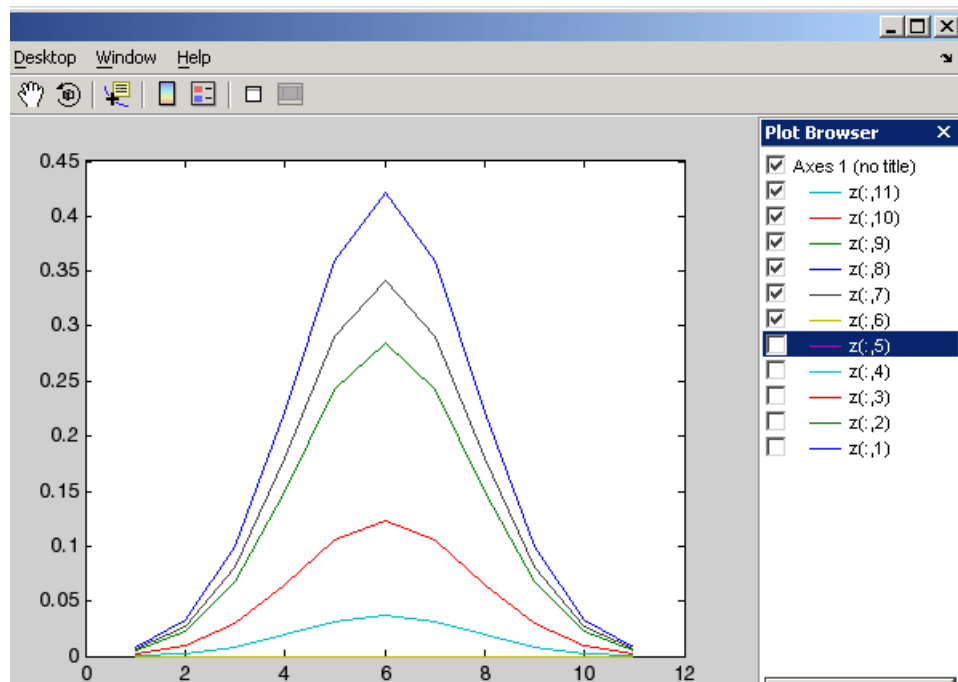

Deleting Objects

You can delete any selected item in the Plot Browser by selecting **Delete** from the right-click context menu.

Adding Data to Axes

The Plot Browser provides the mechanism by which you add data to axes. The procedure is as follows:

- 1 Select a 2-D or 3-D axes from the **New Subplots** subpanel.
- 2 After creating the axes, select it in the Plot Browser panel to enable the **Add Data** button at the bottom of the panel.
- 3 Click the **Add Data** button to display the Add Data to Axes dialog.

The Add Data to Axes dialog enables you to select a plot type and specify the workspace variables to pass to the plotting function. You can also specify a MATLAB expression, which is evaluated to produce the data to plot.

Selecting Workspace Variables to Create a Graph. Suppose you want to create a surface graph from three workspace variables defining the XData, YData, and ZData (see the surf function for more information on this type of graph).

In the workspace you have defined three variables, x, y, and z. To create the graph, configure the Add Data to Axes dialog as shown in the following picture.

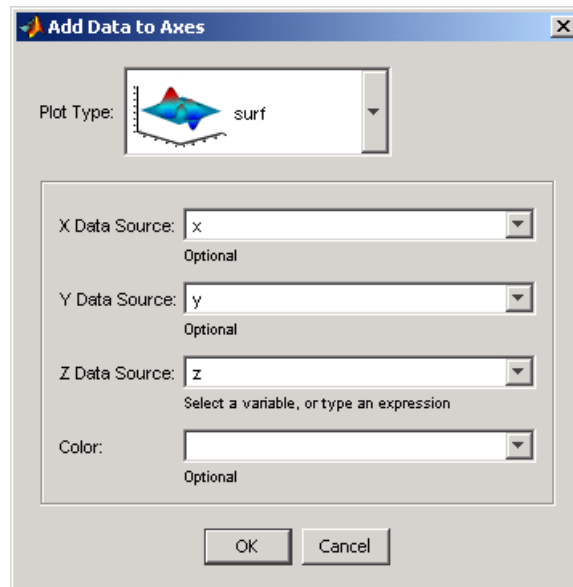

Using a MATLAB Expression to Create a Graph. The following picture shows the Add Data to Axes dialog specifying a workspace variable x for the plot's x data and a MATLAB expression $(x.^2 + 3*x + 5)$ for the y data.

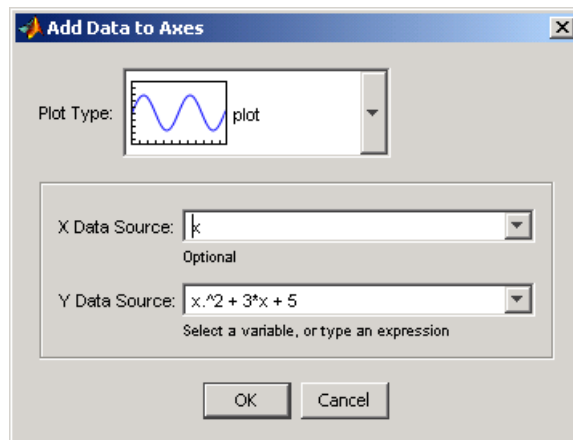

You can use the default **X Data** value of index if you do not want to specify **x** data. In this case, MATLAB plots the **y** data vs. the index of the **y** data value, which is equivalent to calling the `plot` command with only one argument.

The Property Editor

The Properties Editor enables you to access a subset of the selected object's properties. When no object is selected, the Property Editor displays the figure's properties.

Ways to Display the Property Editor

There are a variety of ways to display the Property Editor:

- Double-click an object when plot edit mode is enabled.
- Select an object and right-click to display its context menu, then select **Properties**.
- Select **Property Editor** from the **View** menu.
- Use the `propertyeditor` command.

Changing Plot Types

You can use the property editor to change the type of plot used to display data. For example, you can change the following line graph to a stem, stairs, area, or bar graph by changing the **Plot Type** field.

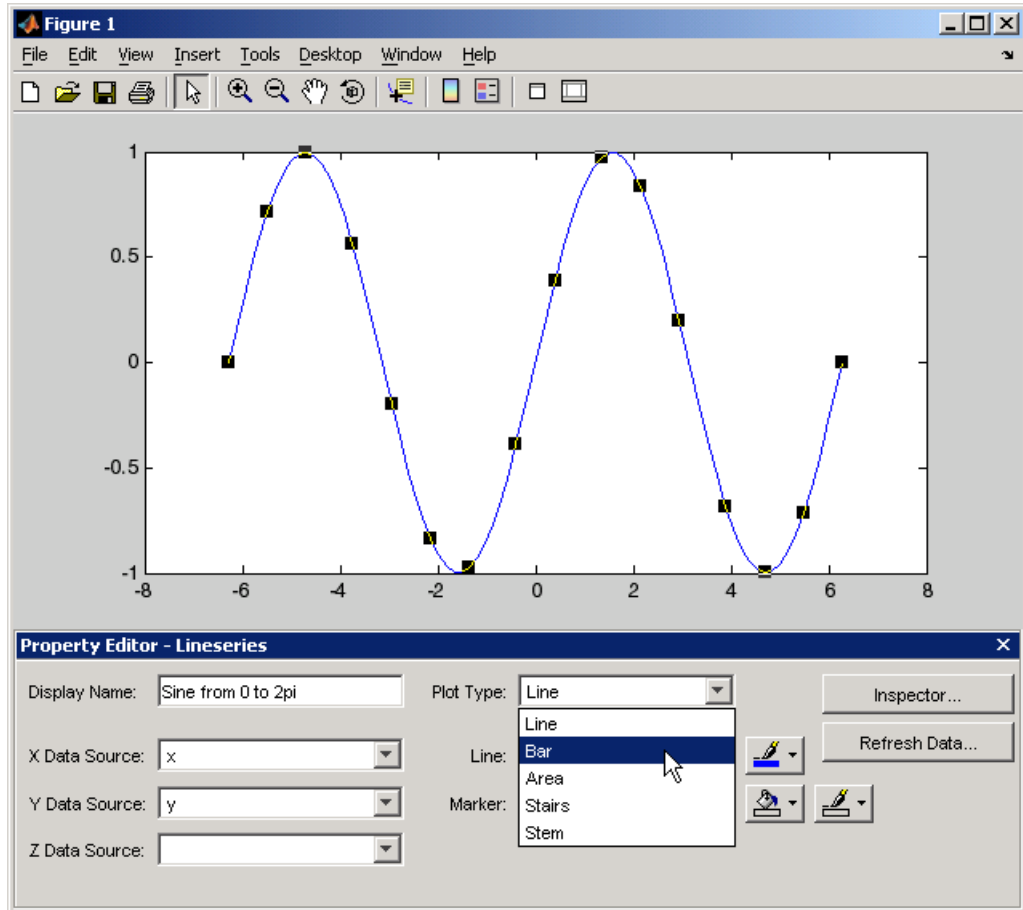

Accessing All Object Properties – Property Inspector

The Property Editor enables you to change the most commonly used object properties. If you want to access all object properties, use the Property Inspector. To display the Property Inspector, click the **Inspect** button on any Property Editor panel. The following picture shows the Property Inspector

displaying the properties of the same lineseries object as that in the previous picture.

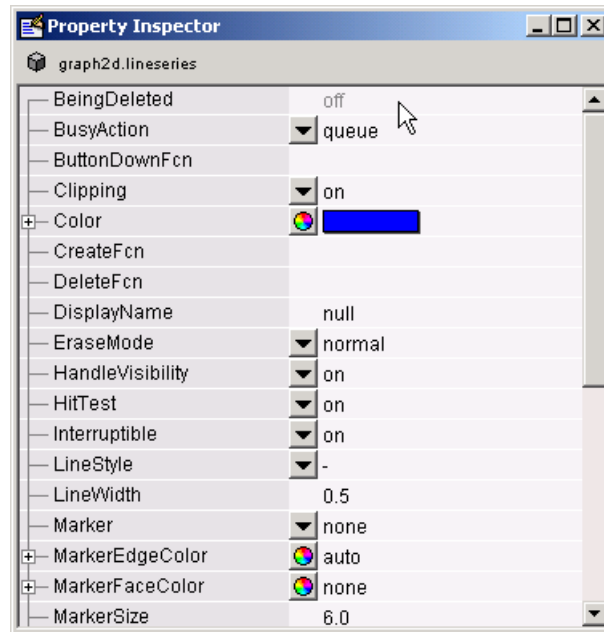

For descriptions of the properties of graphics objects, use the Graphics Property Browser.

Accessing Objects You Cannot Click

If you want to access the properties of light or uicontextmenus objects, you need to get the handle using MATLAB commands, because you cannot click on these objects.

For example, to get the handles of all light objects in the current axes, use `findobj`.

```
h = findobj(gca,'Type','light');
```

Then use the `inspect` command to display the Property Inspector.

```
inspect(h)    % Inspect all light objects
inspect(h(1)) % Inspect the first light object in list
```

Example – Working with Plotting Tools

This example illustrates how to use the plotting tools to graph a workspace variable vs. an expression typed into the **Add Data to Axes** dialog.

Create a variable in the workspace,

```
x = -2*pi:pi/25:2*pi;
```

Use the `plottools` command to create a figure with the plotting tools attached.

```
plottools
```

Click **2D Axes** in the **New Subplot** panel of the Figure Palette.

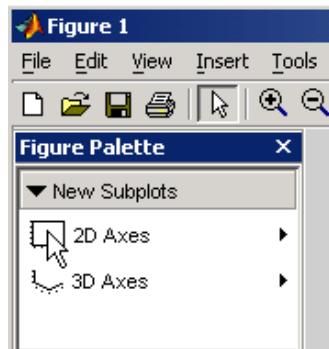

Once the axes appears, the **Add Data** button on the Plot Browser is activated. Click this button to display the Add Data to Axes dialog.

When the Add Data to Axes dialog is displayed, enter the following values:

- Select plot as the **Plot Type**.
- Set **X Data Source** to `x`.
- Set **Y Data Source** to `sin(x).^2`.
- Click **OK** to plot this data.

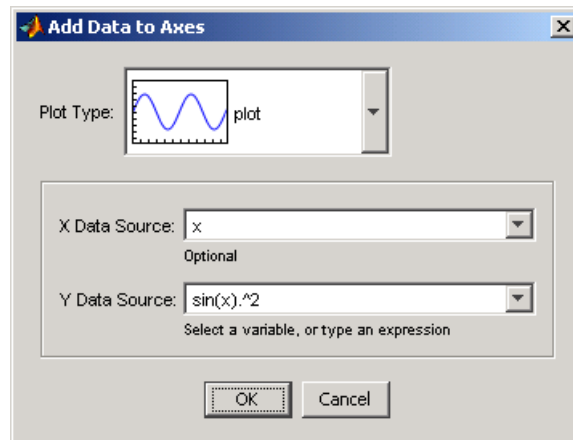

MATLAB draws a plot of $\sin(x) \cdot ^2$ vs. x .

Now add another plot to the same axes. Click **Add Data** again and specify the data to plot:

- Set **X Data Source** to x .
- Set **Y Data Source** set to $\sin(x) \cdot ^8$.
- Click **OK** to plot this data.

Select the last plot (the green line) and set the **Plot Type** in the Property Editor to Stem. The plot should now look like the following picture.

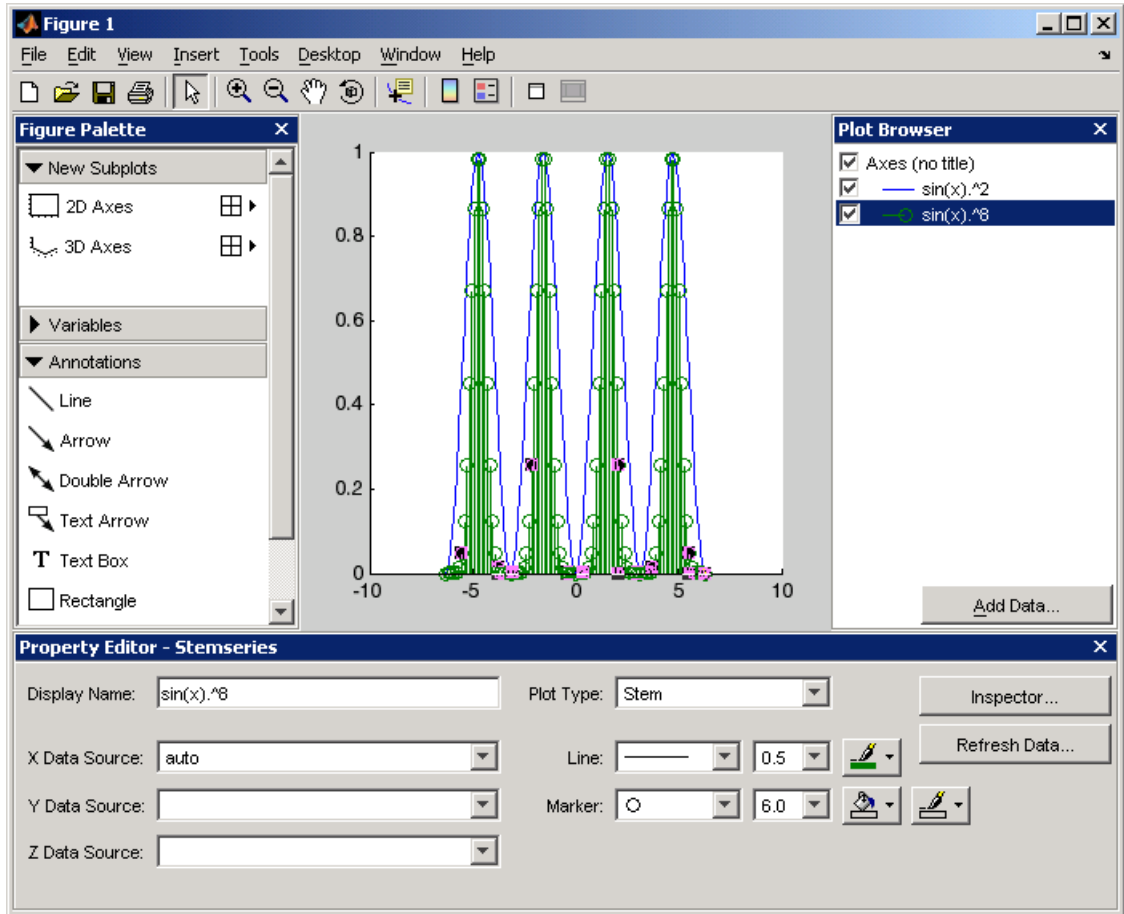

Adding a Subplot

Add a second axes below the current axes using the **New Subplots** panel. Click the right-facing arrowhead next to **2D Axes** and move the mouse to darken two squares, one on top of the other. This creates a subplot axes below the existing axes. MATLAB resizes the existing axes so both fit in the figure.

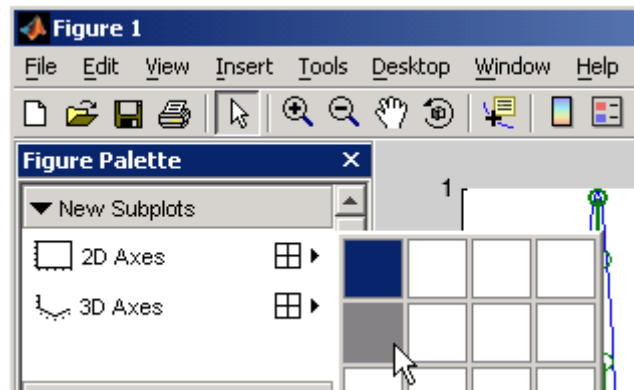

Once MATLAB inserts the new axes, select its entry in the Plot Browser and then click **Add Data**.

When the Add Data to Axes dialog is displayed, enter the following values:

- Set **X Data Source** to x .
- Set **Y Data Source** to $\sin(x).^3$.
- Click **OK** to plot this data.

Now add another plot overlaid on the first by clicking **Add Data** again and specify the data to plot:

- Set **X Data Source** to x .
- Set **Y Data Source** to $\sin(x).^9$.
- Click **OK** to plot this data.

Select the plot labeled $\sin(x).^9$ under the second axes in the Plot Browser. Set the **Plot Type** in the Property Editor to Area.

Setting Axis Limits

Adjust the x -axis in both axes using the Property Editor.

- Select the first axes in the Plot Browser.
- Change **X Limits** to -7 and 7.

Repeat these steps for the second axes.

Adding Titles and Labels

Select the first axes in the Plot Browser and set the following properties in the Property Editor:

- Set **Title** to Even Powers.
- Set **X Label** to X.
- Click the **Y Axis** tab and set **Y Label** to Sine of X.

Select the second axes in the Plot Browser and set the following properties in the properties panel:

- Set **Title** to Odd Powers.
- Set **Axis label** to Sine of X.
- On the **Y Axis** tab, set **Axis label** to Sine of X.

Note that the Plot Browser reflects the new axes names.

The following picture shows the result of these steps.

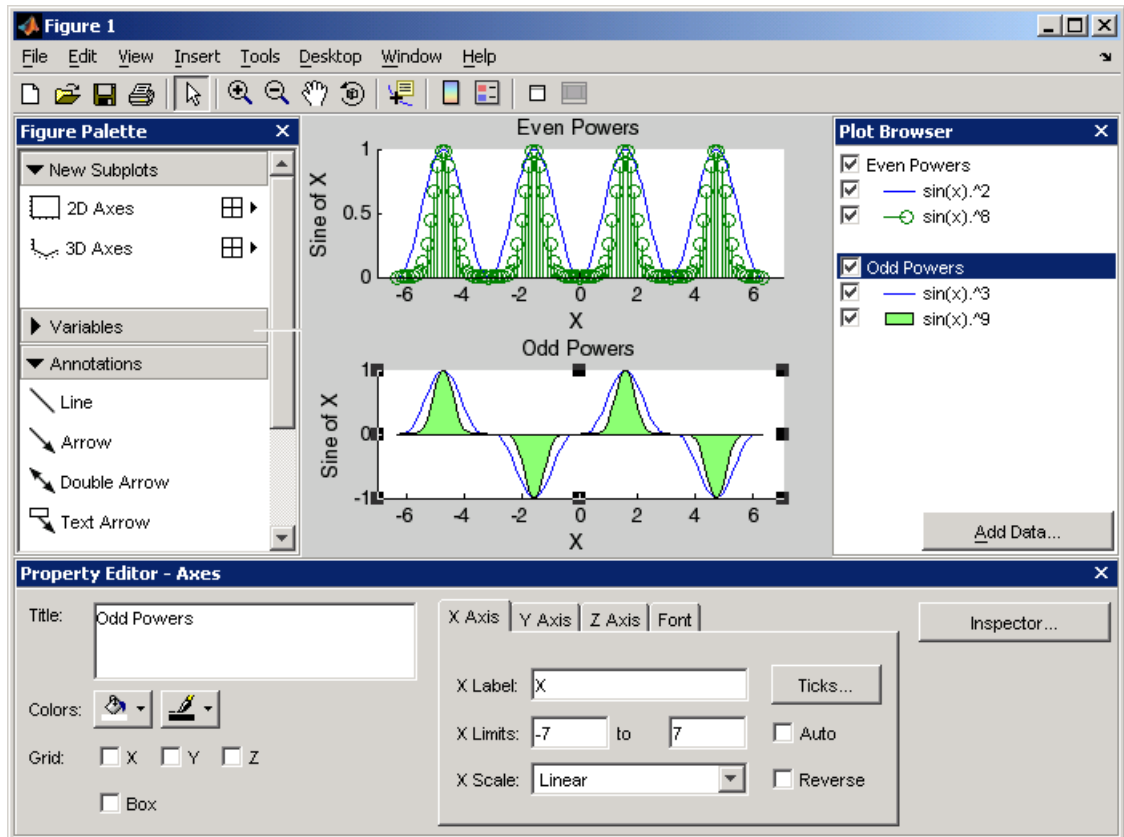

Select the text of the y-axis label on the first axes (now labeled **Even Powers** in the Plot Browser) and click the **Inspector** button on the Property Editor. Set the Rotation property to 0 and reposition the text by hand.

To make more space for the y-axis label, which is now in a horizontal position, select the axes and move it to the right with the mouse.

Repeat this process for the second axes (labeled **Odd Powers** in the Plot Browser).

The repositioned text label now looks like the following picture.

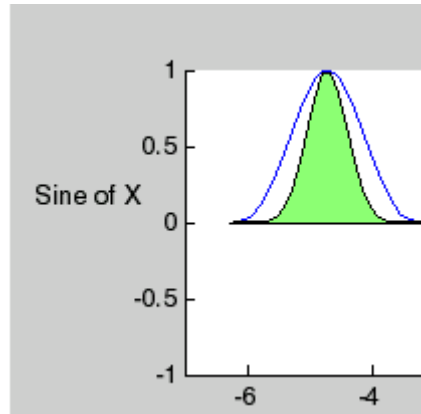

Note You can always undo your last change to the graph by selecting **Undo** from the **Edit** menu.

Example — Plotting Workspace Variables

This example shows how to use the Figure Palette to select variables to plot. Suppose you have three variables in your workspace (x, y, z) created by the following statements:

```
[x,y] = meshgrid([-2:.2:2]);
z = x.*exp(-x.^2-y.^2);
```

You decide to visualize this data as a surface/contour plot (as produced by the `surf` function).

The first step is to display a figure with the Figure Palette tool attached. You can do this with the `figurepalette` command.

```
figurepalette
```

Expand the **Variables** panel and **shift-click** (for multiple selection) on the three variables you want to pass the plotting function. Since `surf` is not in the list, select **More Plots**.

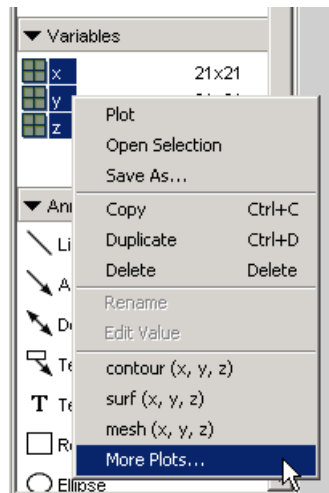

From the Plot Catalog tool, select the **3D Surfaces** in the **Categories** column and **surf** as the **Plot Type**, as shown in the following picture. To create the plot, click the **Plot** button.

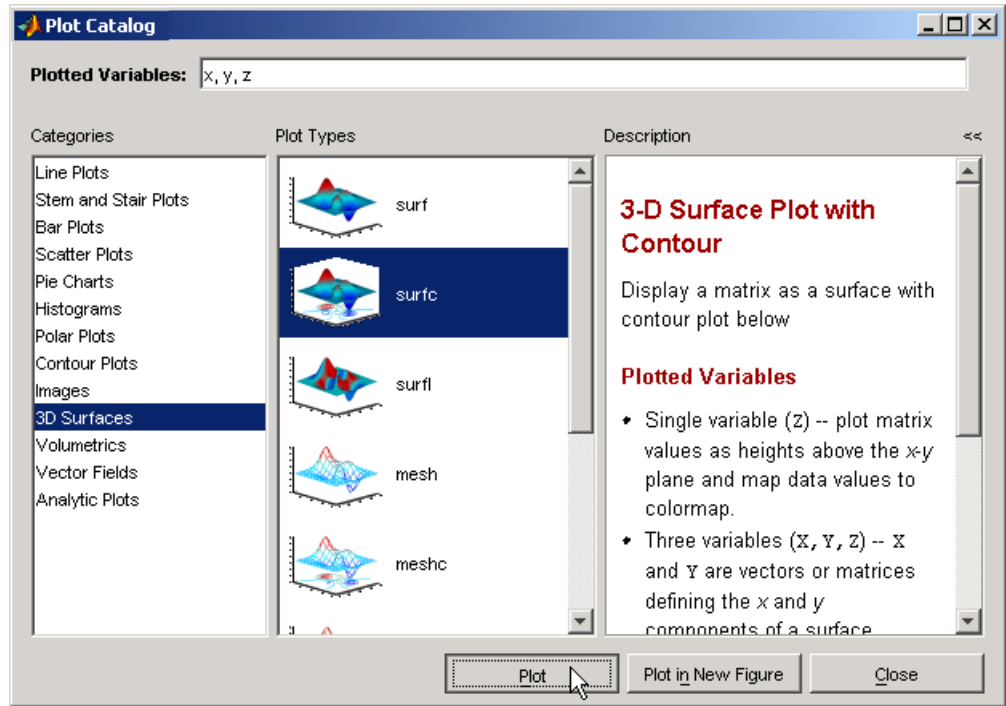

MATLAB creates the following graph.

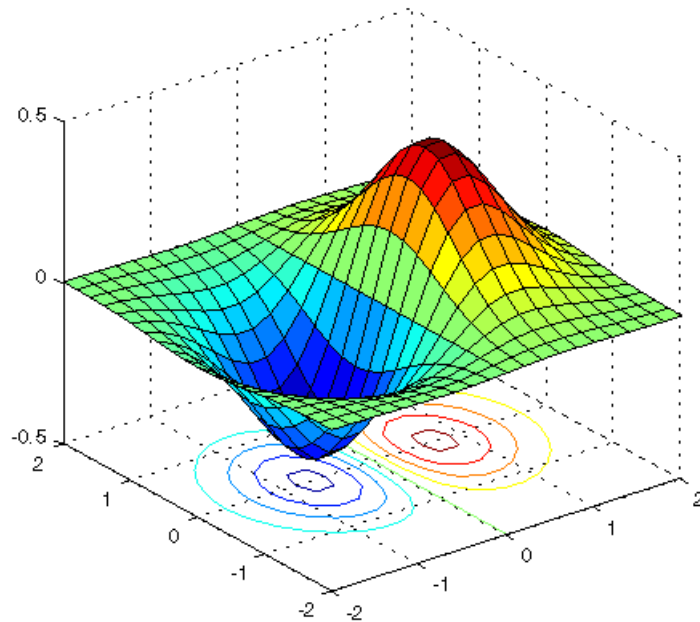

Plotting Expressions

You can enter MATLAB expressions in the Plot Catalog tool, as well as variables. For example, suppose you have created the following variables in the workspace.

```
t = 0:.01:20;  
alpha = .055;
```

and you want to plot t vs. this expression:

```
exp(-alpha*t).*sin(.5*t)
```

The first step is to display a figure with the Figure Palette tool attached. You can do this with the `figurepalette` command.

```
figurepalette
```

First select the variable t and right-click to display the context menu. Select **More Plots**.

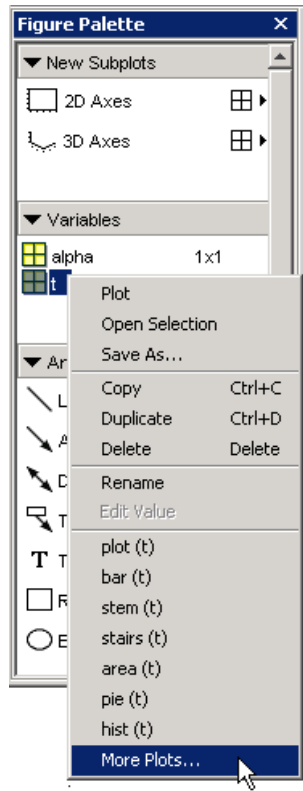

When the Plot Catalog tool is displayed, add the expression to the **Plotted Variables** text field. Note that you can reference the variable **alpha** because you created it in the base workspace. See **MATLAB Workspace** for information about variables in the MATLAB workspace.

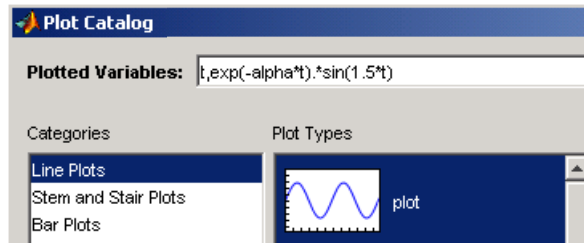

Click the **Plot** button to create the graph. Note that the previous step is the equivalent of issuing the following command:

```
plot(t,exp(-alpha*t).*sin(.5*t))
```

Example – Specifying a Data Source

Plot objects have properties that enable you to specify the source of the data that defines the object. For example, you can specify a workspace variable name or a MATLAB expression as the value of the `XDataSource`, `YDataSource`, or `ZDataSource` property for a line in a plot (i.e., a lineseries object). You can then use the Property Editor to change the variable name or alter the expression, and the plot is updated to reflect the change.

Creating the Graph

First define two variables by issuing these statements in the command window.

```
t = 0:.01:20;  
alpha = .055;
```

Next plot `t` vs. the expression `exp(-alpha*t).*sin(.5*t)` using the `plot` function or the plot tools.

```
plot(t,exp(-alpha*t).*sin(.5*t))
```

Varying the Data Source

After creating the graph, you can use the Property Editor to couple the plotted line to the MATLAB expression.

- 1 Double-click on the plotted line to display its property panel.
- 2 Enter the MATLAB expression in the **Y Data Source** text field.

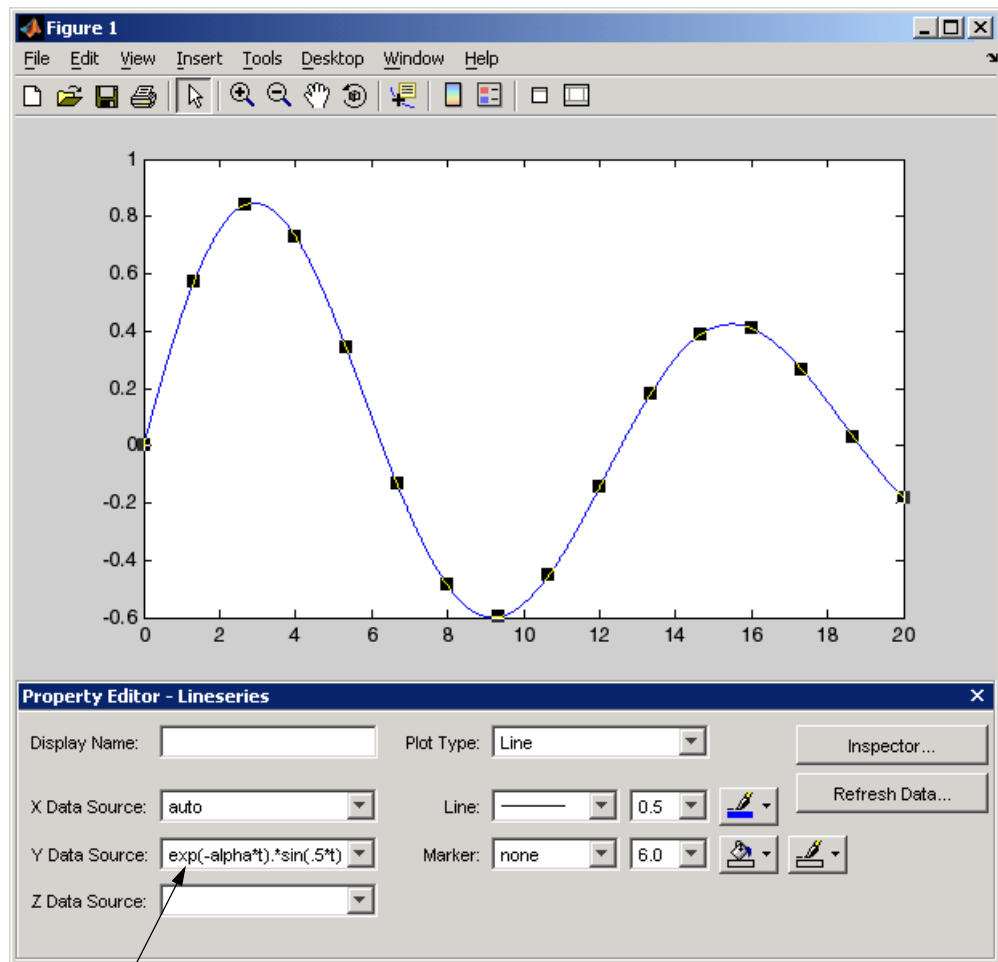

Enter the expression in the **Y Data Source** text field.

You can now modify the expression in the **Y Data Source** text field and observe how the graph changes. After changing the text, click the **Refresh Data** button to update the data.

In the following picture, alpha is no longer negated, so the function grows instead of decays. Also the period has been shortened by changing $\sin(.5*t)$ to $\sin(1.5*t)$.

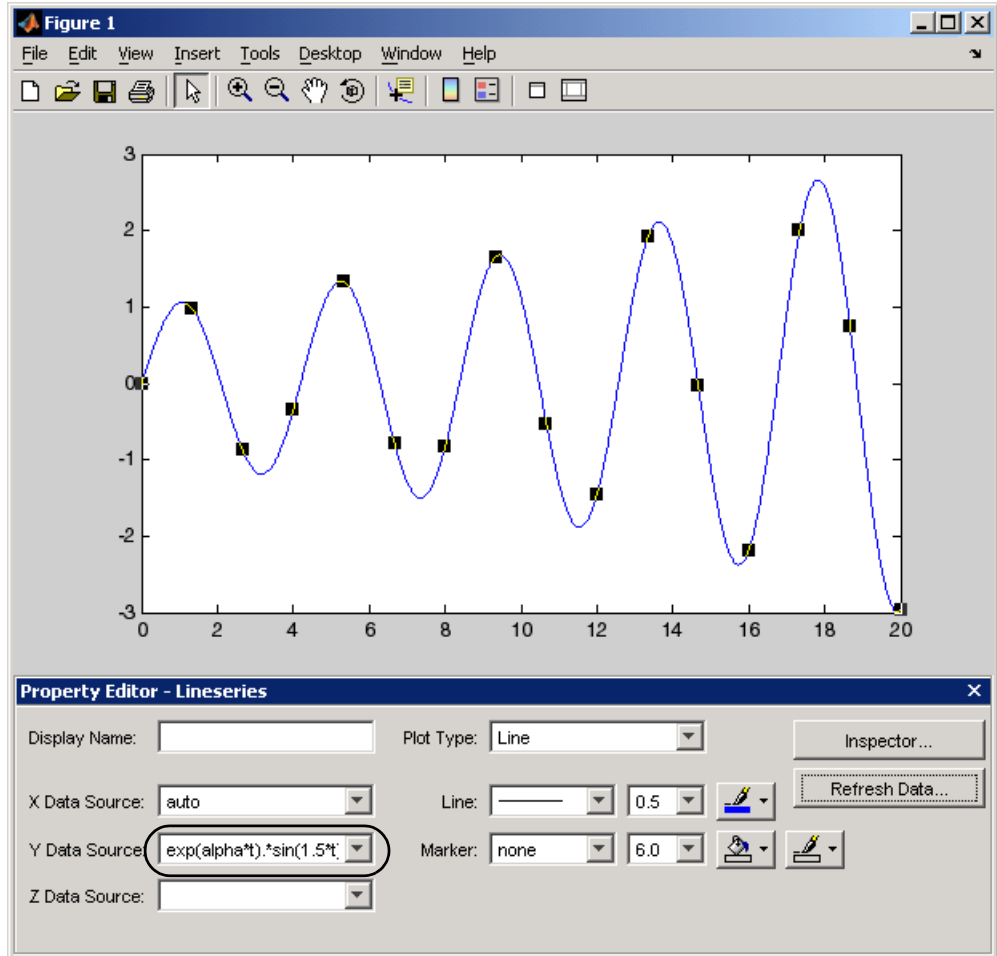

Data Sources for Multiobject Graphs

Suppose you create a line graph from matrix data. For example,

```
z = peaks;  
h = plot(z, 'YDataSource', 'z');
```

Because MATLAB creates one lineseries object for each column of z , the following is true.

The data source for $h(1)$ is $z(:,1)$.

The data source for $h(2)$ is $z(:,2)$.

...

The data source for $h(n)$ is $z(:,n)$.

Example – Generating M-Code to Reproduce a Graph

Suppose you have created the following graph.

```
t = 0:.2:20;  
alpha = .055;  
stem(t,exp(-alpha*t).*sin(5*t))
```

You then use the Property Editor to modify the graph to look like the following picture.

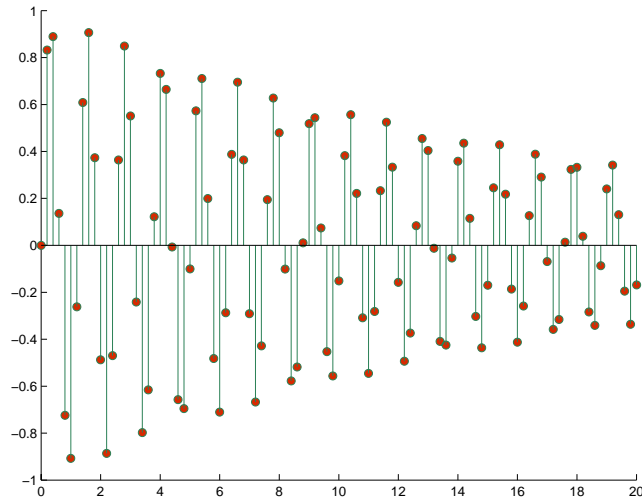

You can generate code to reproduce this graph by selecting **Generate M-File** from the **Figure** menu. MATLAB creates a function that recreates the graph and opens the generated M-File in the editor.

This feature is particularly useful for capturing property settings and other modifications made using the plot tools GUI.

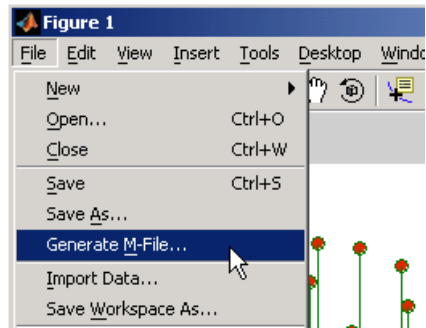

Data Arguments

You must supply the data arguments t and $\exp(-\alpha t) \cdot \sin(5t)$ to the function. Generated functions do not store the data necessary to recreate the graph.

Limitations

Attempting to generate code for graphs containing a large number of graphics objects (e.g., greater than 20 plotted lines) might be impractical.

Editing Plots

MATLAB formats a graph to provide readability, setting the scale of axes, including tick marks on the axes, and using color and line style to distinguish the plots in the graph. However, if you are creating presentation graphics, you might want to change this default formatting or add descriptive labels, titles, legends, and other annotations to help explain your data.

MATLAB supports two ways to edit the plots you create:

- Using the mouse to select and edit objects interactively
- Using MATLAB functions at the command line or in an M-file

Interactive Plot Editing

If you enable plot editing mode in the MATLAB figure window, you can perform point-and-click editing of your graph. In this mode, you can modify the appearance of a graphics object by double-clicking on the object and changing the values of its properties. You access the properties through a graphical user interface called the Property Editor.

For more information about interactive editing, see “Using Plot Edit Mode” on page 1-37.

For information about editing object properties in plot editing mode, see “The Property Editor” on page 1-15.

Using Functions to Edit Graphs

If you prefer to work from the MATLAB command line or if you are creating an M-file, you can use MATLAB commands to edit the graphs you create. Taking advantage of the MATLAB Handle Graphics® system, you can use the set and get commands to change the properties of the objects in a graph.

Note Plot editing mode provides an alternative way to access the properties of MATLAB graphic objects. However, you can only access a subset of object properties through this mechanism. You might need to use a combination of interactive editing and command-line editing to achieve the effect you desire.

Using Plot Edit Mode

To start plot edit mode, click this button.

Use the **Edit**, **Insert**, and **Tools** menus to add objects or edit existing objects in a graph.

Use these toolbar buttons to add a legend, text, and arrows.

Double-click on an object to select it.

Position labels, legends, and other objects by clicking and dragging.

Access object-specific plot edit functions through context-sensitive pop-up menus.

The MATLAB figure window supports a point-and-click editing mode that you can use to customize the appearance of your graph. This section describes how to start plot edit mode and perform basic editing tasks, including

- “Selecting Objects in a Graph” on page 1-38
- “Cutting, Copying, and Pasting Objects” on page 1-39
- “Moving and Resizing Objects” on page 1-39
- “Setting Object Properties” on page 1-40
- “Saving Your Work” on page 1-42

Starting Plot Edit Mode

Before you can select objects in a figure by clicking on them, you must activate plot editing mode. There are several ways to activate plot edit mode:

- Choose the **Edit Plot** option on the figure window **Tools** menu.
- Click the selection button in the figure window toolbar.

Click this button to start plot edit mode.



- Choose an option from the **Edit** or **Insert** menu. For example, if you choose the **Axes Properties** option on the **Edit** menu, MATLAB activates plot edit mode and the axes appear selected.
- Run the `plotedit` command in the MATLAB Command Window.
- Start the plotting tools with the `plottools` command.

When a figure window is in plot edit mode, the **Edit Plot** option on the **Tools** menu is checked and the selection button in the toolbar is depressed.

Exiting Plot Edit Mode

To exit plot edit mode, click the selection button or click the **Edit Plot** option on the **Tools** menu. When plot edit mode is turned off, the selection button is no longer depressed.

Selecting Objects in a Graph

To select an object in a graph,

- 1 Start plot edit mode.
- 2 Move the cursor over the object and click it.

Selection handles appear on the selected object.

Selecting Multiple Objects

To select multiple objects at the same time,

- 1 Start plot edit mode.
- 2 Move the cursor over an object and **shift+click** to select it. Repeat for each object you want to select.

You can perform actions on all the selected objects. For example, to remove a textbox annotation and an arrow annotation from a graph, select the objects and then select **Cut** from the **Edit** menu.

Deselecting Objects

To deselect an object, move the cursor off the object onto the figure window background and click the left mouse button. You can also **shift+click** on a selected object to deselect it.

Cutting, Copying, and Pasting Objects

To cut an object from a graph, or copy and paste an object in a graph, perform these steps:

- 1 Start plot edit mode.
- 2 Select the object.
- 3 Select the **Cut**, **Copy**, or **Paste** option from the **Edit** menu or use standard shortcut keys for your platform.

Alternatively, with plot edit mode enabled, you can right-click on an object and then select an editing command from the context menu associated with the object.

Moving and Resizing Objects

To move or resize an object in a graph, perform these steps:

- 1 Start plot edit mode.
- 2 For axes objects only: unlock the axes by right-clicking on an empty region and choosing **Unlock Axes Position** from the context menu.
- 3 Select the object. Selection handles appear on the object.

To move the object, drag it to the new location.

To resize the object, drag a selection handle.

Note You can move text objects, but you cannot resize them.

Setting Object Properties

In MATLAB, every object in a graph supports a set of properties that control the graph's appearance and behavior. For example, line objects have properties that control thickness, color, and line style.

Double-clicking on an object displays the Property Editor. To edit the properties of the axes or figure, double-click on a region that does not contain other objects.

See “The Property Editor” on page 1-15 for more information.

Undo/Redo – Eliminating Mistakes

The figure **Edit** menu contains two items that enable you to undo recent operation.

Undo — Remove the effect of the last operation.

Redo — Perform again the last operation that you removed by selecting **Undo**.

For example, if you create a plot, zoom in, pan the view, and then undo the pan operation, the menu looks as follows:

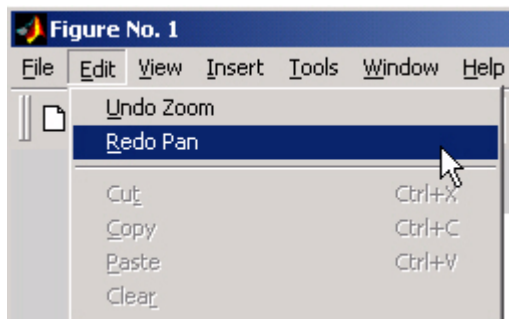

You could now undo the previous zoom operation or redo the pan operation you just undid.

Saving Your Work

After editing a graph, you can

- Save your work in a format that can be opened during another MATLAB session
- Save your work in a format that can be used by other applications

Saving a Graph in MAT-File Format

Note To save a figure in a format that is compatible with MATLAB versions before MATLAB 7, refer to “Plot Objects and Backward Compatibility” on page 8-20 for more information.

MATLAB supports a binary format in which you can save figures so that they can be opened in subsequent MATLAB sessions. MATLAB assigns these files the `.fig` filename extension.

To save a graph in a figure file,

- 1** Select **Save** from the figure window **File** menu or click the **Save** button on the toolbar. If this is the first time you are saving the file, the **Save As** dialog box appears.
- 2** Make sure that the **Save as type** is **Fig-File**.
- 3** Specify the name you want assigned to the figure file.
- 4** Click **OK**.

The graph is saved as a figure file (`.fig`), which is a binary file format used to store figures.

You can also use the `saveas` command.

Use the `hgsave` command to create backward compatible Fig-Files.

If you want to save the figure in a format that can be used by another application, see “Saving to a Different Format — Exporting Figures” on page 1-43.

Opening a Figure File

To open a figure file, perform these steps:

- 1 Select **Open** from the **File** menu or click the **Open** button on the toolbar.
- 2 Select the figure file you want to open and click **OK**.

The figure file appears in a new figure window.

You can also use the open command.

Saving to a Different Format – Exporting Figures

To save a figure in a format that can be used by another application, such as the standard graphics file formats TIFF or EPS, perform these steps:

- 1 Select **Export Setup** from the **File** menu. This dialog provides options you can specify for the output file, such as the figure size, fonts, line size and style, and output format.
- 2 Select **Export** from the Export Setup dialog. A standard Save As dialog appears.
- 3 Select the format from the list of formats in the **Save as type** drop-down menu. This selects the format of the exported file and adds the standard filename extension given to files of that type.
- 4 Enter the name you want to give the file, less the extension.
- 5 Click **Save**.

Copying a Figure to the Clipboard

On Windows systems, you can also copy a figure to the clipboard and then paste it into another application:

- 1 Select **Copy Options** from the **Edit** menu. The **Copying Options** page of the **Preferences** dialog box appears.
- 2 Complete the fields on the **Copying Options** page and click **OK**.

- 3** Select **Copy Figure** from the **Edit** menu.

The figure is copied to the Windows clipboard. You can then paste the figure from the Windows clipboard into a file in another application.

Printing Figures

Before printing a figure,

- 1** Select **Page Setup** from the **File** menu to set printing options.

The **Page Setup** dialog box opens.

- 2** Make changes in the dialog box. If you want the printed output to match the annotated plot you see on the screen exactly,
 - a** On the **Size and Position** tab, click **Use screen size, centered on page**.
 - b** On the **Axes and Figure** tab, click **Keep screen limits and ticks**.

For information about other options for page setup, click the **Help** button in the dialog box.

To print a figure, select **Print** from the figure window **File** menu and complete the **Print** dialog box that appears.

You can also use the `print` command.

Generating an M-File to Recreate a Graph

You can generate an M-file from a graph, which you can then use to regenerate the graph. This approach is a useful way to generate M-code for work you have performed with the plotting tools. To use this option,

- 1** Select **Generate M-file** from the **File** menu.

MATLAB displays the generated code in the MATLAB Editor.

- 2** Save the M-file using **Save As** from the Editor **File** menu.

Running the Saved M-File

Most of the generated M-files require you to pass in data as arguments. The M-file assumes you are using the same data originally used to create the graph.

Comments at the beginning of the M-file state the type of data expected. For example, the following statements illustrate a case where three input vectors are required.

```
function createplot(X1, Y1, Y2)
%CREATEPLOT(X1,Y1,Y2)
% X1: vector of x data
% Y1: vector of y data
% Y2: vector of y data
```

See “Example — Generating M-Code to Reproduce a Graph” on page 1-34 for another example.

Data Exploration Tools

Ways to Explore Graphical Data (p. 2-2)	Overview of tools for exploring graph data
Data Cursor — Displaying Data Values Interactively (p. 2-3)	Data cursors enable you to read data directly off a graph, save it in the workspace, and label data points
Zooming in 2-D and 3-D (p. 2-11)	Behavior of zoom tools in 2- and 3-D
Panning — Moving Your View of the Graph (p. 2-14)	Tool that grabs the graph with the mouse and moves it within the axes
Rotate 3D — Interactive Rotation of 3-D Views (p. 2-15)	Move the viewpoint around 3-D objects
Analyzing Graphical Data (p. 2-18)	Performing curve fitting and basic statistical analysis on graphs

Ways to Explore Graphical Data

After determining what type of graph best represents your data, you can further enhance the visual display of information using the tools discussed in this section. These tools enable you to explore data interactively, eliminating the need to set the plethora of graphics properties required to achieve the same results using MATLAB commands.

Once you have achieved the desired results, you can then generate the MATLAB code necessary to reproduce the graph you created interactively. See “Example — Generating M-Code to Reproduce a Graph” on page 1-34 for more information.

Types of Tools

See the following sections for information on specific tools.

- “Data Cursor — Displaying Data Values Interactively” on page 2-3
- “Zooming in 2-D and 3-D” on page 2-11
- “Panning — Moving Your View of the Graph” on page 2-14
- “Rotate 3D — Interactive Rotation of 3-D Views” on page 2-15
- Camera Toolbar — Interacting with 3-D Views

Data Cursor — Displaying Data Values Interactively

Topics in this section:

- “Enabling Data Cursor Mode” on page 2-3
- “Selection Style — Select Data Points or Interpolate Points on Graph” on page 2-8
- “Display Style — Datatip or Cursor Window” on page 2-7
- “Exporting Data Value to Workspace Variable” on page 2-9

Data cursors enable you to read data directly from a graph by displaying the values of points you select on plotted lines, surfaces, images, and so on.

When data cursor mode is enabled, you can

- Click on any graphics object defined by data values and display the x, y, and z (if 3-D) values of the nearest data point.
- Interpolate the values of points between data points.
- Display multiple data tips on graphs.
- Display the data values in a cursor window that you can locate anywhere in the figure window or as a data tip (small text box) located next to the data point.
- Export data values as workspace variables.
- Print or export the graph with data tip or cursor window displayed for annotation purposes.

Enabling Data Cursor Mode

Select the data cursor icon in the figure toolbar  or select the **Data Cursor** item in the **Tools** menu.

Once data cursor mode is enabled, clicking the mouse on a line or other graph object returns the data value of the point clicked. For example, in the following picture, the black square is the point selected and the values are displayed in the data tip next to the point.

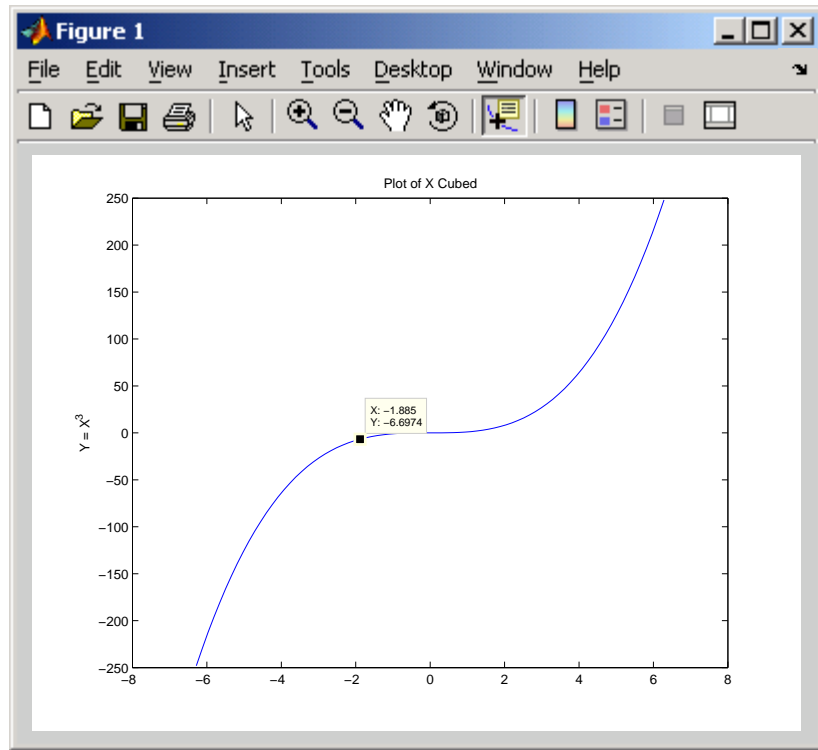

Moving the Marker

You can move the marker using the arrow keys and the mouse. The up and right arrows move the marker to data points having greater index values in the data arrays. The down and left arrow keys move the marker to data points having lesser index values.

Positioning the Datatip Text Box

You can position the data tip text box in any one of four positions with respect to the data point: upper right (the default), upper left, lower left, and lower right.

To position the datatip, press, but do not release the mouse button while over the datatip text box and drag it to one of the four positions.

You can move a datatip using the arrow keys as well as the mouse.

Dragging the Datatip to Different Locations

You can drag the datatip to different locations on the graph object by clicking down on the datatip and dragging the mouse. You can also use the arrow keys to move the datatip.

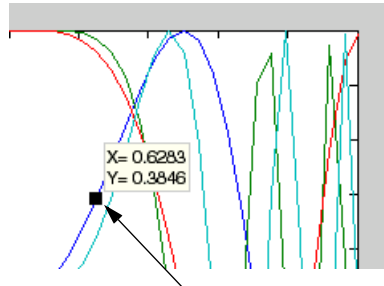

Click on the square and drag the data tip along the blue line.

Datatips on Image Objects

Datatips on images display the x - and y -coordinates as well as the RGB values.

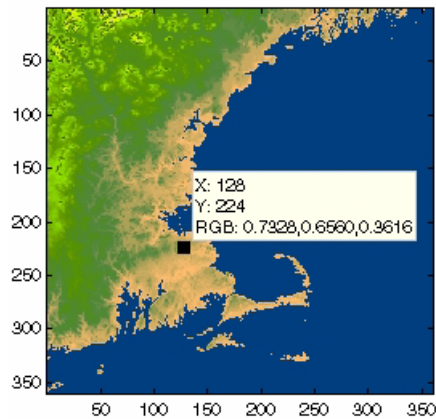

Datatypes on 3-D Objects

You can use datatips to read data points on 3-D graphs as well. In 3-D views, data tips display the x -, y - and z -coordinates.

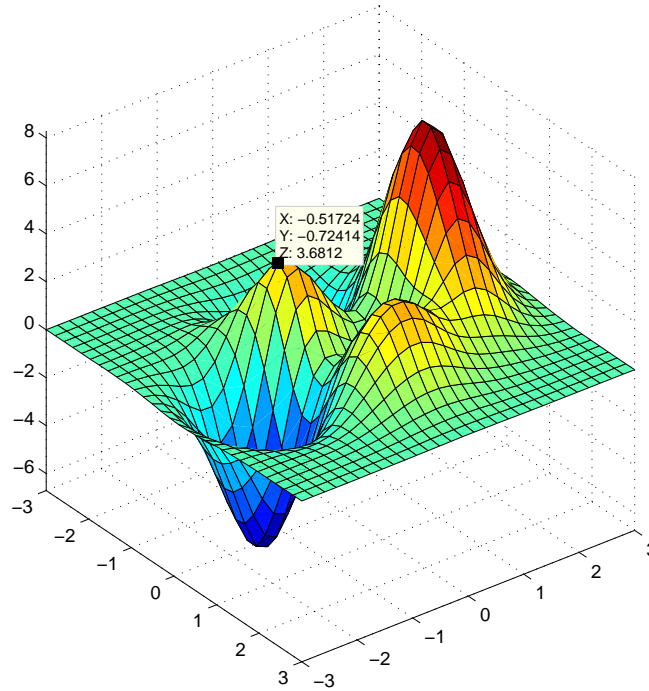

Creating Multiple Data Tips

Normally, there is only one datatip displayed at one time. However, you can display multiple datatips simultaneously on a graph. This is a simple way to annotate a number of points on a graph.

Use the following procedure to create multiple datatips.

- 1 Enable data cursor mode from the figure toolbar. The cursor changes to a cross.
- 2 Click on the graph to insert a datatip.
- 3 Right-click to display the context menu. Select **Create New Datatip**.

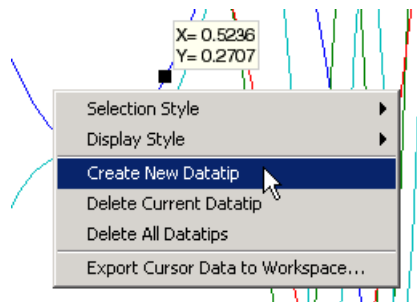

4 Click on the graph to place the second datatip.

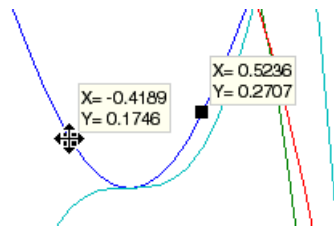

Customizing Data Cursor Text

You can customize the text displayed by the data cursor using the `datacursormode` function. See the Examples section of the `datacursormode` reference page for more information.

Deleting Datatips

You can remove the most recently added datatip or all datatips. When in data cursor mode, right-click to display the context menu.

- Select **Delete Current Datatip** to delete the last datatip that you added.
- Select **Delete All Datatips** to delete all datatips.

Display Style — Datatip or Cursor Window

By default, the data cursor displays values as a datatip (small text box located next to the data point). You can also display the data values in a cursor

window. You can place multiple datatips on a graph, which makes this display style useful for annotations.

To use the cursor window, change the display style as follows:

- 1 While in data cursor mode, right-click to display the context menu.
- 2 Mouse over the **Display Style** item.
- 3 Select **Window Inside Figure**.

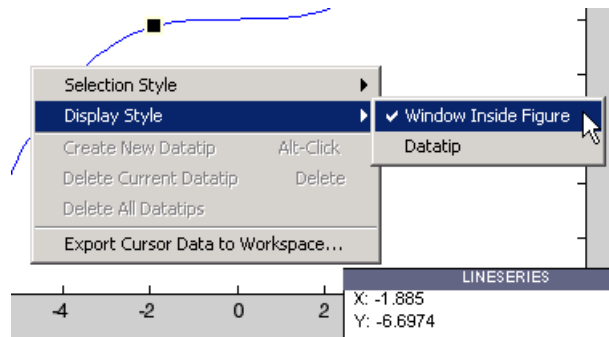

Selection Style – Select Data Points or Interpolate Points on Graph

By default, the data cursor displays the values of the data point nearest to the point you click with the mouse, and the data marker snaps to this point. The data cursor can also determine the values of points that lie in between the data defining the graph, by linearly interpolating between the two data points closest to the location you click the mouse.

Enabling Interpolation Mode

If you want to be able to select any point along a graph and display its value, use the following procedure:

- 1 While in data cursor mode, right-click to display the context menu.
- 2 Mouse over the **Selection Style** item.

3 Select Mouse Position.

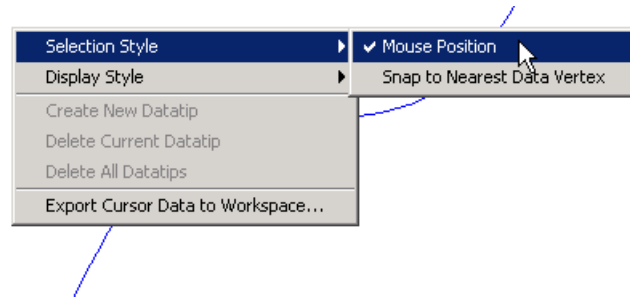

Note that interpolation mode does not work when you are using the arrow keys.

Exporting Data Value to Workspace Variable

You can export the values displayed with the data cursor to MATLAB workspace variables. To do this, display the right-click context menu while in data cursor mode and select **Export Cursor Data to Workspace**.

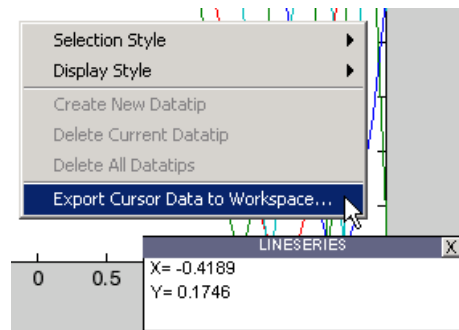

MATLAB then displays a dialog that enables you to name the workspace variable.

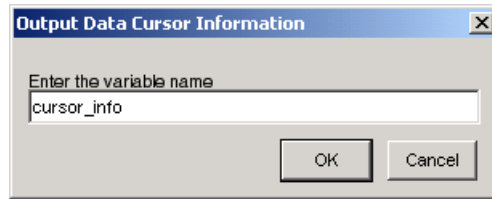

When you click **OK**, MATLAB creates a structure with the specified name in your base workspace, containing the following fields:

- **Target** — Handle of the graphics object containing the data point
- **Position** — x - and y - (and z -) coordinates of the data cursor location in axes data units

Line and lineseries objects have an additional field:

- **DataIndex** — A scalar index into the data arrays that correspond to the nearest data point. The value is the same for each array.

For example, if you saved the workspace variable as `cursor_info`, then you would access the position data by referencing the `Position` field.

```
cursor_info.Position
ans =
    0.4189 0.1746 0
```

Zooming in 2-D and 3-D

Zooming changes your view of a graph. Zooming is useful to see greater detail in a smaller area. Zoom behaves differently depending on whether it is applied to a 2-D or 3-D view.

Enable zooming by clicking one of the zoom icons . Select + to zoom in and - to zoom out.

Note, when in zoom in mode, you can use **Alt-Click** to zoom out (i.e., press and hold down the **Alt** key while clicking the mouse).

Zooming in 2-D Views

In 2-D views, click the area of the axes where you want to zoom in, or drag the cursor to draw a box around the area you want to zoom in on. MATLAB redraws the axes, changing the limits to display the specified area.

For example, selecting the region of the following plot,

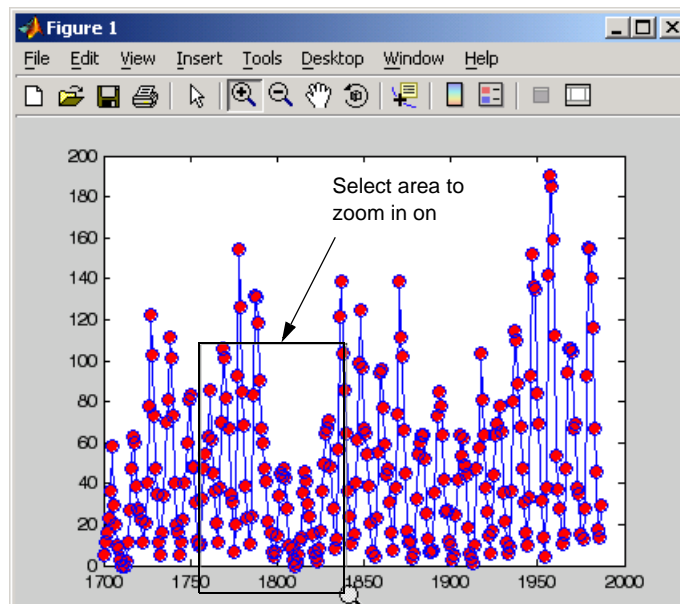

results in a rescaling of the axes to display only that region.

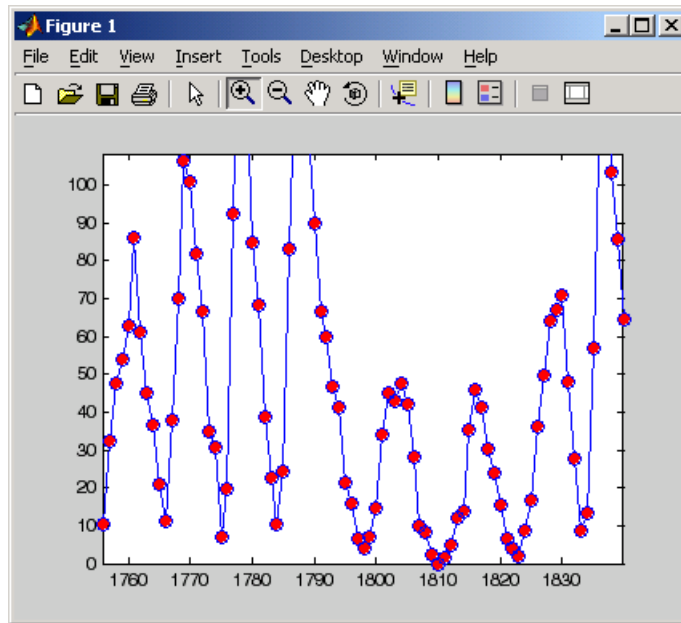

Undoing Zoom Actions

If you want to reset the graph to its original view, right-click to display the context menu and select **Reset to Original View**. You can also use the **Undo** item on the **Edit** menu to undo each operation you performed on your graph.

Zoom Constrained to Horizontal or Vertical

In 2-D views, you can constrain zoom to operate in either the horizontal or vertical direction. To do this, right-click to display the context menu while in zoom mode and select the desired zoom option.

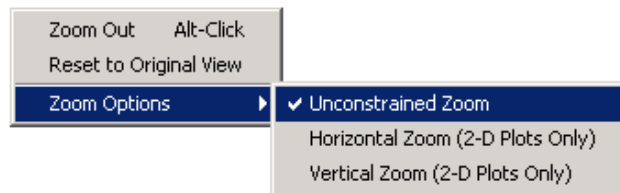

Zooming in 3-D Views

In 3-D views, moving the cursor up or to the right zooms in, while moving the cursor down or to the left zooms out. Both toolbar icons enable the same behavior. 3-D zooming does not change the axes limits, as in 2-D zooming. Instead it changes the view (specifically, the axes `CameraViewAngle` property) as if you were looking through a camera with a zoom lens.

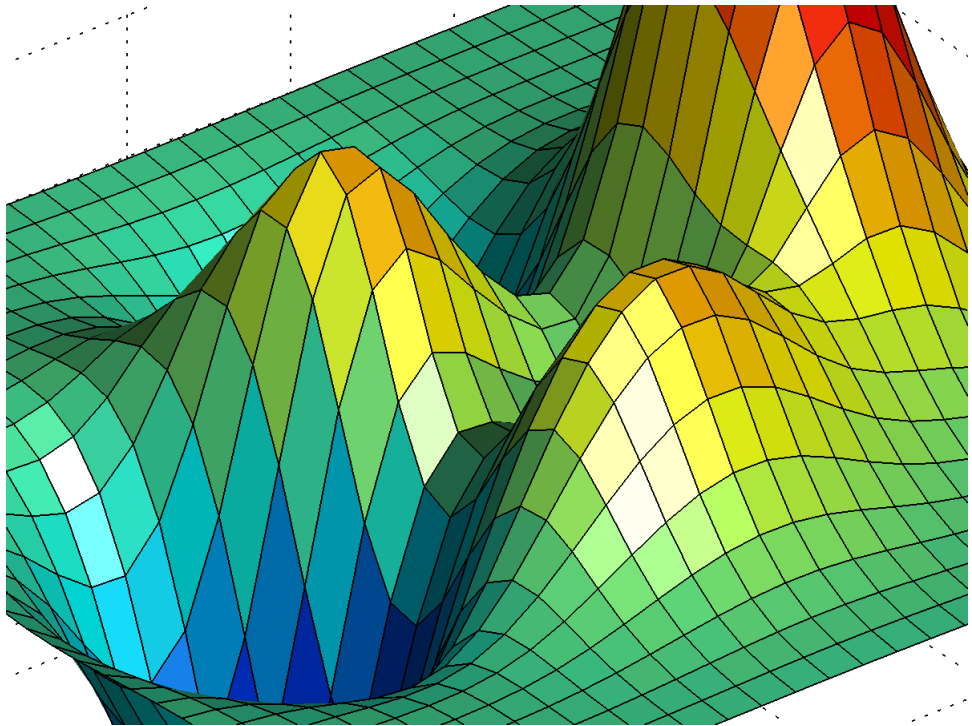

Panning – Moving Your View of the Graph

You can move your view of a graph up and down as well as left and right with the pan tool. Panning is useful when you have zoomed in on a graph and want to translate the plot to view different portions.

Click this icon on the figure toolbar to enable panning .

2-D vs. 3-D Panning

2-D panning has the effect of changing the axis limits that you are viewing, but it does not change the actual limits of the plot. For example, suppose you have a time-series waveform that you want to zoom in on to view detail, but you also want to be able to scan the entire plot.

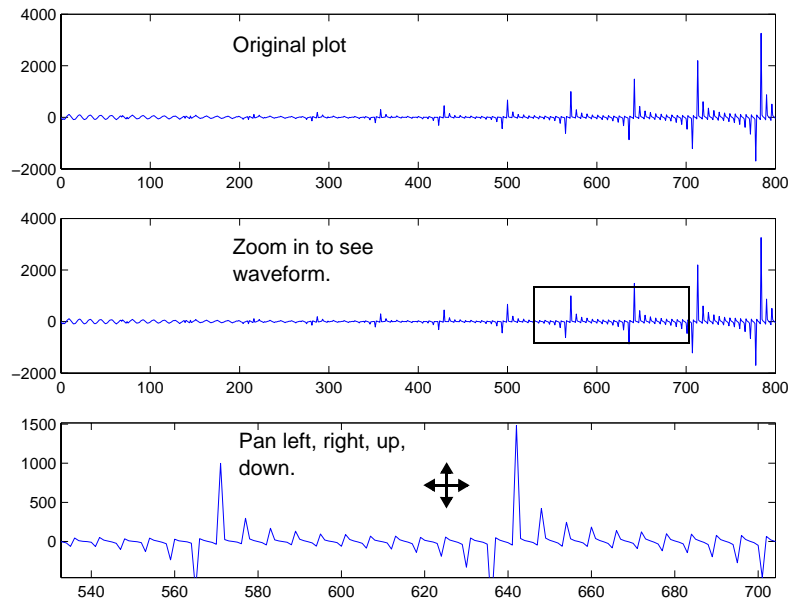

3-D panning moves the axes with the object, because the 3-D view is not aligned to the x -, y -, or z -axis. The axes limits do not change as in 2-D panning.

Rotate 3D — Interactive Rotation of 3-D Views

MATLAB enables you to rotate graphs to any orientation with the mouse. Rotation involves the reorientation of the axes and all the graphics objects it contains. Therefore none of the data defining the graphics objects is affected by rotation; instead the orientation of the x -, y -, and z -axes changes with respect to the viewer.

Enabling Rotate 3D

There are three ways to enable Rotate 3D mode:

- Select **Rotate 3D** from the **Tools** menu.
- Click the Rotate 3D icon in the figure toolbar .
- Execute the `rotate3d` command.

Once the mode is enabled, you press and hold the mouse button while moving the cursor to rotate the graph.

Selecting Predefined Views

When Rotate 3D mode is enabled, you can control various rotation options from the right-click context menu.

You can rotate to predefined views on the right-click context menu:

- **Reset to Original View** — Reset to the default MATLAB view (azimuth -37.5° , elevation 30°).
- **Go to X-Y View** — View graph along the z -axis (azimuth 0° , elevation 90°).
- **Go to X-Z View** — View graph along the y -axis (azimuth 0° , elevation 0°).
- **Go to Y-Z View** — View graph along the x -axis (azimuth 90° , elevation 0°).

Rotation Style for Complex Graphs

You can select from two rotation styles on the right-click context menu's **Rotation Options** submenu:

- **Plot Box Rotate** — Display only the axes bounding box for faster rotation of complex objects. Use this option if the default **Continuous Rotate** style is unacceptably slow.

- **Continuous Rotate** — Display all graphics during rotation.

Axes Behavior During Rotation

You can select two types of behavior with respect to the aspect ratio of axes during rotation:

- **Stretch-to-Fill Axes** – Default axes behavior is optimized for 2-D plots. Graphs fit the rectangular shape of the figure.
- **Fixed Aspect Ratio Axes** – Maintains a fixed shape of objects in the axes as they are rotated. Use this setting when rotating 3-D plots.

The following pictures illustrate a sphere as it is rotated with **Stretch-to-Fill Axes** selected. Note that the sphere is not round.

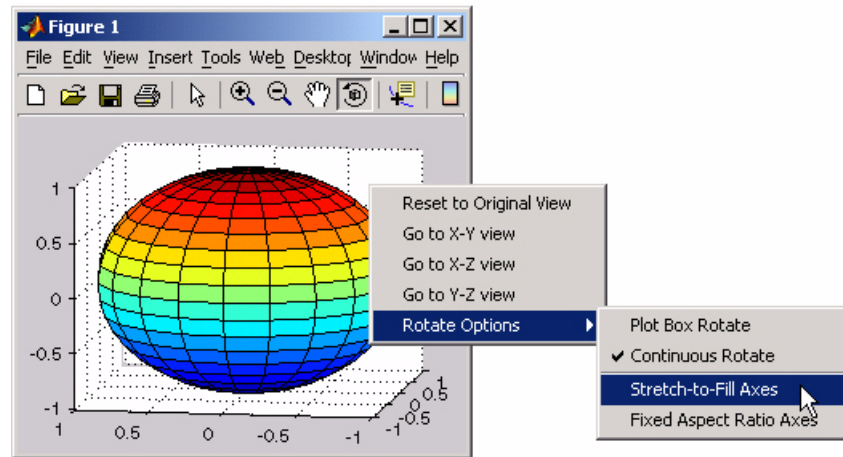

The next picture shows how the **Fixed Aspect Ratio Axes** option results in a sphere that maintains its proper shape as it is rotated.

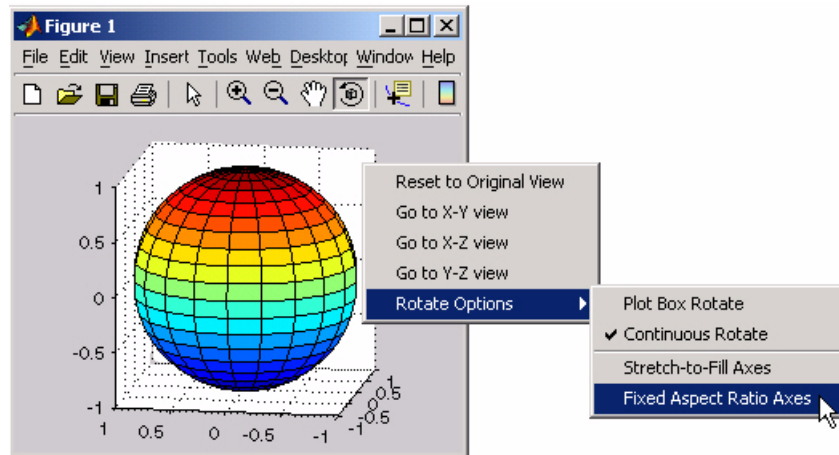

Undo/Redo — Eliminating Mistakes

The figure **Edit** menu contains two items that enable you to undo any zoom, pan, or rotate operation.

Undo — Remove the effect of the last operation.

Redo — Perform again the last operation that you removed by selecting **Undo**.

For example, if you create a plot, zoom in, pan the view, and then undo the pan operation, the menu looks as follows:

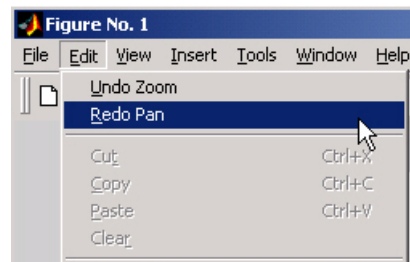

You could now undo the previous zoom operation or redo the pan operation you just undid.

Analyzing Graphical Data

You can perform some analysis directly on graphs with the following tools:

- “Basic Curve Fitting” on page 2-18
- “Adding Plots of Basic Statistics to Graphs” on page 2-20

“Data Analysis and Statistics” section describes more data analysis options.

Basic Curve Fitting

Suppose you have recorded the following values of y at the corresponding intervals of t and you want to fit the data to a polynomial.

```
y = [-5.00 -5.74 -6.41 -5.67 -4.10 -1];  
t = [0 .40 .80 1.20 1.60 2.00];
```

First graph the data:

```
plot(t,y)
```

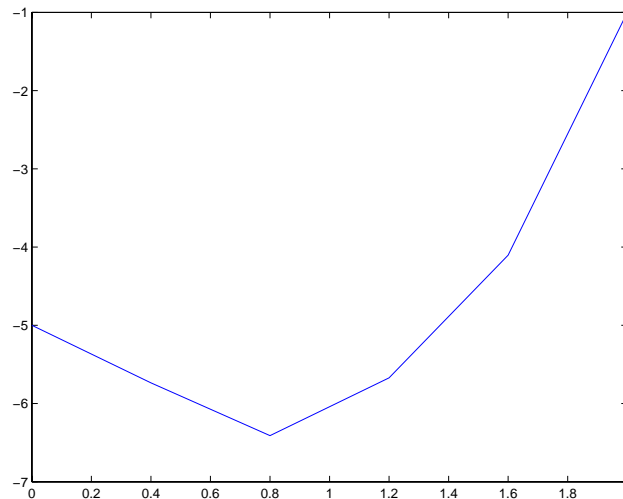

Next display the Basic Fitting tool by selecting **Basic Fitting** from the **Tools** menu. Try to fit the data to a cubic polynomial.

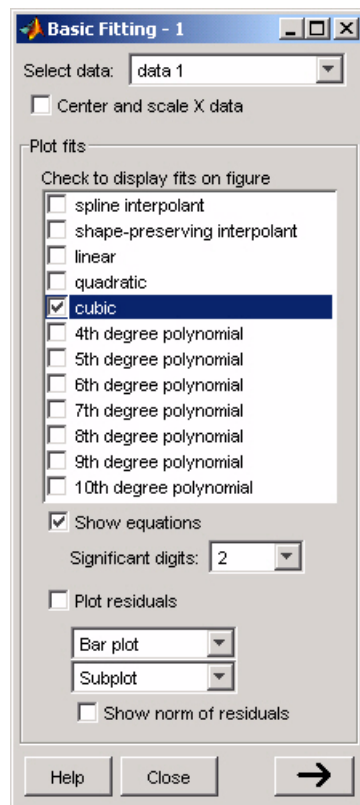

When you check cubic, the Basic Fitting tool fits the data to a cubic polynomial and displays a graph of the polynomial over the same range as your data. The tool also (optionally) displays the equation showing the coefficients used to fit the data.

Click the tool's **Help** button for more information.

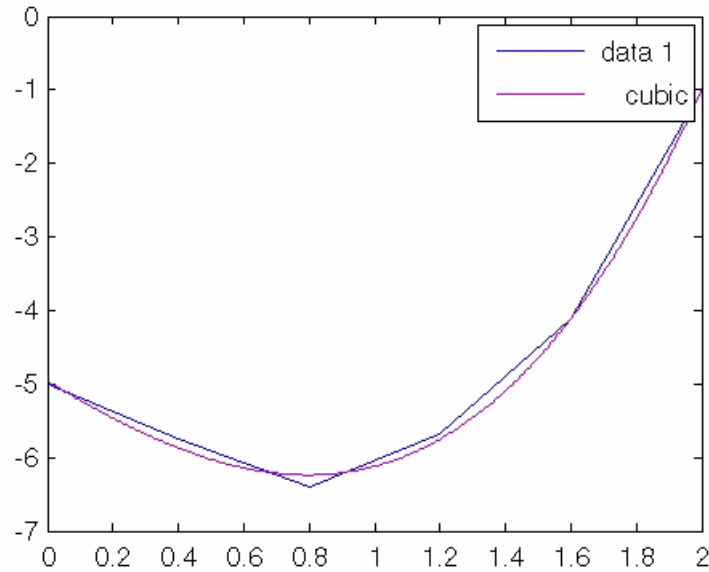

Adding Plots of Basic Statistics to Graphs

The MATLAB Data Statistics tool calculates basic statistics about the central tendency and variability of data plotted in a graph and then plots these statistics in the same graph.

To obtain statistics, select **Data Statistics** from the MATLAB figure window **Tools** menu. MATLAB calculates the statistics for each data set plotted in the graph and displays the results in the **Data Statistics** dialog box.

For example, the following plot indicates the mean directly on the plot of the distribution.

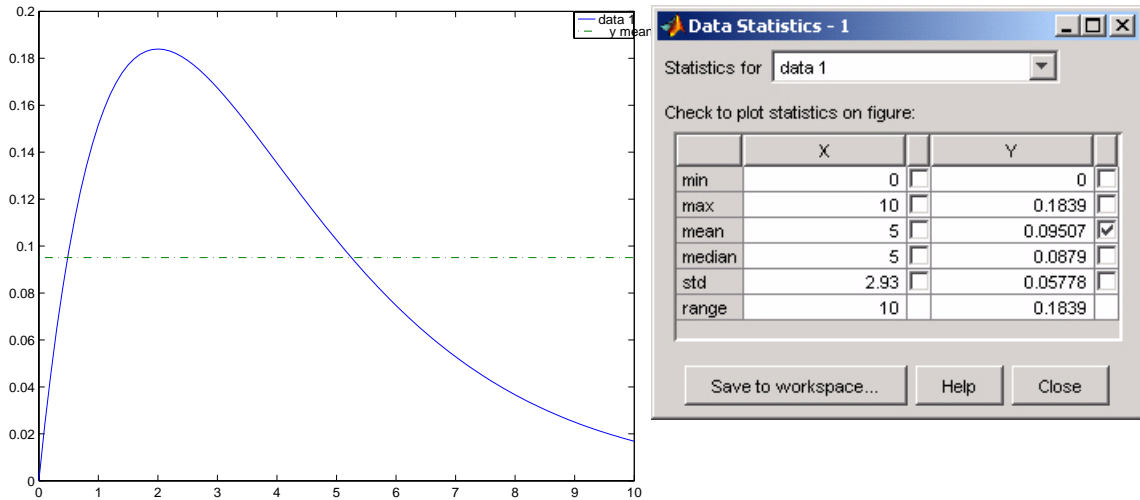

Saving Statistics to the Workspace

To save a set of statistics as a workspace variable, click the **Save to workspace** button. The Data Statistics tool saves the statistics as a structure.

Examples

The following sections provide more information about using the Data Statistics tool:

- “Example — Plotting the Mean of a Data Set” on page 2-21
- “Formatting Plots of Data Statistics” on page 2-23
- “Statistics Plotted by the Data Statistics Tool” on page 2-24
- “Viewing Statistics for Multiple Plots” on page 2-25
- “Saving Statistics to the MATLAB Workspace” on page 2-26

Example — Plotting the Mean of a Data Set

To add a plot of the mean of a data set to a graph,

- 1 Plot your data. For example, use these commands to plot historical population data from the United States census.

```
load census
plot(cdate, pop, '+' )
```

- 2 Select the **Data Statistics** option from the figure window **Tools** menu.

The Data Statistics tool calculates basic statistics on the *x*-data and *y*-data of the plot in the graph and displays the results in a dialog box.

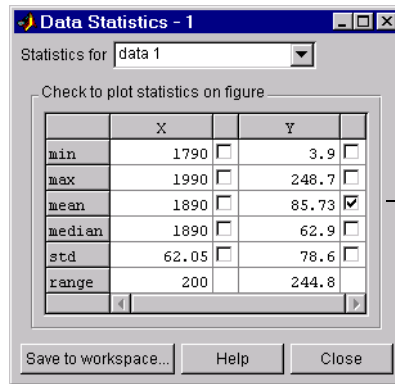

Select the statistic you want to plot by clicking in its check box.

- 3 Select the statistic you want to plot in your graph by clicking in the check box next to the value.

For example, to add a plot of the mean of the population data (*y*-data) to the graph, click in the check box next to the value (as shown in the figure). The Data Statistics tool adds the plot of the mean to the graph.

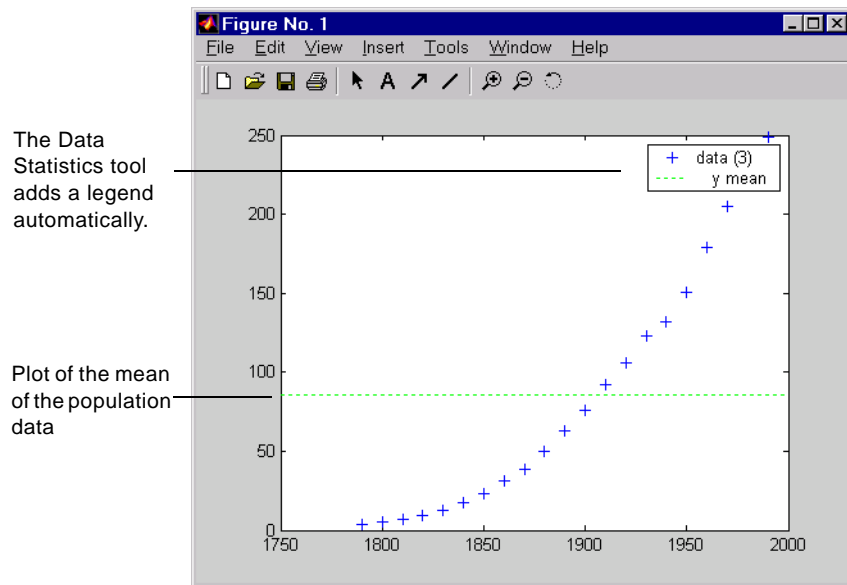

Using a Legend with Data Statistics

When you activate the Data Statistics tool, it calculates statistics for the plotted data and automatically adds a legend to the graph, if the graph doesn't already have one.

When you add a plot of one or more statistics to the graph, the Data Statistics tool adds an entry in the legend for the new plot. The Data Statistics tool assigns the plotted statistic a descriptive name that identifies it in the legend. In the example, the plotted statistic has the name *y mean* in the legend.

Formatting Plots of Data Statistics

The Data Statistics tool uses color and line style to distinguish the plots of statistics from the other plots in a graph. However, as with any other plot in a graph, you can change these characteristics.

Note Do not edit the format of the plots of data statistics until you are finished adding them to a graph. If you edit a plot of data statistics, delete the plot, and then add it back, any formatting you did to the plotted statistics will be lost.

To modify the properties of a plotted statistic,

- 1 Enable plot editing mode in the figure window.
- 2 Double-click on the plot of the statistic. This starts the Property Editor, which provides access to properties of the line object used to plot the statistic.

You can also access a subset of these properties by right-clicking on the plot. This brings up the plot's context menu, which includes options for specifying line width, line style, and color.

- 3 Change the properties of the plot and click **Apply**.

Statistics Plotted by the Data Statistics Tool

Note You can only use the Data Statistics tool to generate statistics for two-dimensional data (vectors and matrices).

The following table lists the statistics calculated by the Data Statistics tool. The table includes the name of the MATLAB function used to calculate the statistic. For more information about these statistical functions, see “Basic Data Analysis Functions” in the MATLAB Math documentation.

Statistic	Description	MATLAB Function
Maximum	Largest value in the data set	max
Minimum	Smallest value in the data set	min

Statistic	Description	MATLAB Function
Mean	Average of all the values in the data set	mean
Median	Middle value in the data set	median
Range	Interval between the lowest value and the highest value in the data set. The Data Statistic tool does not plot the range statistic.	n/a
Standard deviation	<p>A measure characterizing the amount of variation among the values in the data set</p> <p>Note: The Data Statistics tool uses two lines to plot the standard deviation in a graph. The lines represent the boundaries of one standard deviation on either side of the mean of the data set.</p>	std

Automatic Updating of Statistics

If you have the Data Statistics tool displayed and you change the x -data or y -data of a plot, the Data Statistics tool automatically regenerates the statistics for that plot.

Viewing Statistics for Multiple Plots

The Data Statistics tool calculates basic statistics for every 2-D plot in a graph, but displays the statistics for only one plot at time.

To view the statistics for a particular plot in a graph,

- 1 Click the **Statistics for** menu in the Data Statistics dialog box.

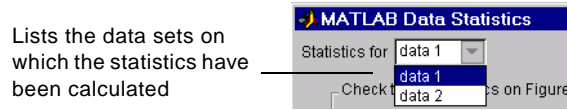

This menu lists all the data sets plotted in the graph, identifying each data set by its tag. (A tag is a user-defined text string that can be associated with any graphics object.) For plots in the graph that do not have tags, the Data Statistics tool uses data1 to identify the first plot, data2 to identify the second plot, and so on.

- 2 Select a plot from the list. The Data Statistics tool updates the values displayed in the dialog box.

Saving Statistics to the MATLAB Workspace

To save the statistics generated by the Data Statistics tool to the MATLAB workspace, follow this procedure:

Note You must repeat this procedure for each plot in a graph containing multiple plots.

- 1 Click the **Save to Workspace** button.
- 2 In the **Save Statistics to Workspace** dialog box, specify the sets of statistics you want to save, x -data or y -data, and specify the names you want to assign to the variables in which the statistics will be stored.

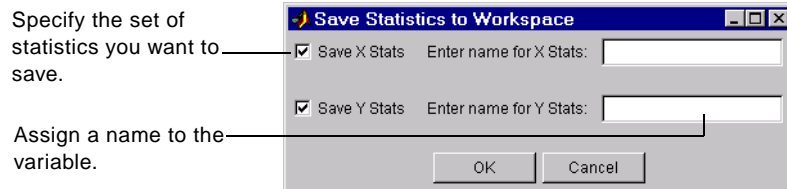

The Data Statistics tool saves each set of statistics in a structure. For example, if you save the set of statistics on the x -data in the census in the variable `census_dates`, the contents of the structure looks like this.

```
census_dates =  
    min: 1790  
    max: 1990  
    mean: 1890  
median: 1890  
    std: 62.0484  
    range: 200
```

Annotating Graphs

How to Annotate Graphs (p. 3-2)	Summary of the options for formatting graphs
Alignment Tool — Aligning and Distributing Objects (p. 3-19)	How to arrange axes and annotations within a graph
Adding Titles to Graphs (p. 3-26)	Illustrates the procedure for adding a title to a graph
Adding Axis Labels to Graphs (p. 3-29)	Illustrates the procedure for adding axis labels to a graph, and how to add, position, modify, and remove legends from graphs
Adding Text Annotations to Graphs (p. 3-35)	Techniques for using text with graphs, including alignment, symbols and Greek letters, using variables in text strings, multiline text, and text background color
Adding Arrows and Lines to Graphs (p. 3-48)	Illustrates the procedure for adding callout arrows and lines to graphs

How to Annotate Graphs

Annotating graphs with text and other explanatory material can improve the graph's ability to convey information. This section describes techniques available in MATLAB for creating annotations.

Graph Annotation Features

MATLAB provides a variety of features for annotating graphs, including those that

- Add text, lines and arrows, rectangles, ellipses, and other annotation objects anywhere on the figure
- Anchor annotations to locations in data space
- Add a legend and colorbar
- Add axis labels and titles
- Edit the properties of graphics objects

The following sections provide more information.

- “Enclosing Regions of a Graph in a Rectangle or an Ellipse” on page 3-5
- “Textbox Annotations” on page 3-7
- “Annotation Lines and Arrows” on page 3-9
- “Adding a Colorbar to a Graph” on page 3-13
- “Adding a Legend to a Graph” on page 3-15
- “Pinning — Attaching to a Point in the Figure” on page 3-16

Annotation Tools on the Plot Edit Toolbar

Select **Plot Edit Toolbar** from the **View** menu to display the toolbar.

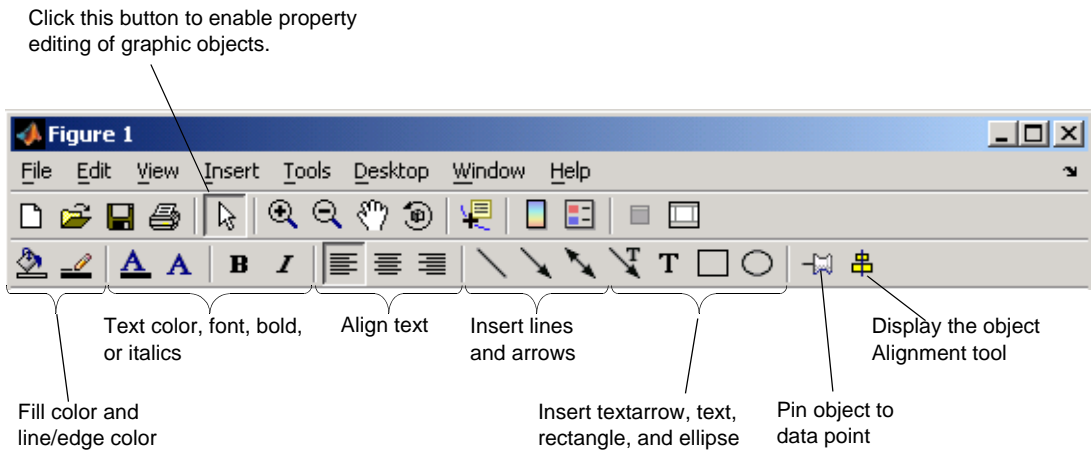

Annotation Tools on the Figure Palette

Basic annotation tools are available from the figure palette. Select **Figure Palette** from the **View** menu to display the figure palette.

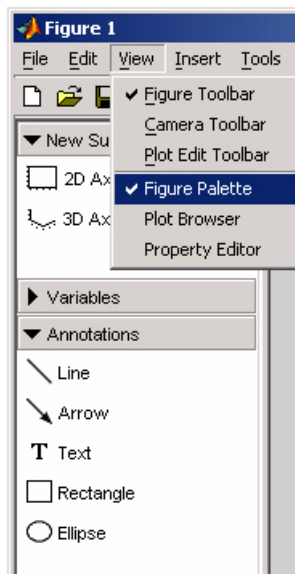

Adding Annotations from the Insert Menu

Annotation features are available from the **Insert** menu.

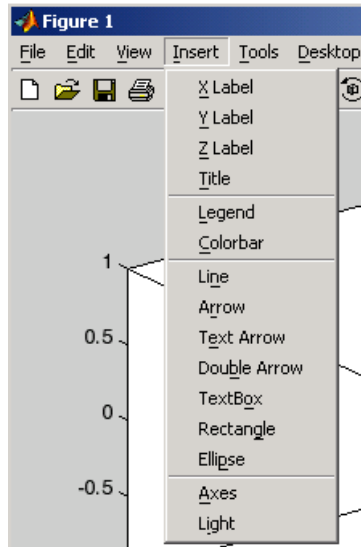

Command Interface

You can add annotations using MATLAB commands. The following table lists the functions used to create annotations.

MATLAB Functions for Creating Annotations

Function	Purpose
annotation	Create annotations including lines, arrows, text arrows, double arrows, text boxes, rectangles, and ellipses
xlabel, ylabel, zlabel	Add a text label to the respective axis
title	Add a title to a graph
colorbar	Add a colorbar to a graph
legend	Add a legend to a graph

Enclosing Regions of a Graph in a Rectangle or an Ellipse

You can add a rectangle or an ellipse to draw attention to a specific region of a graph. While either object is selected, you can move and resize it as well as display a right-click context menu that enables you to modify behavior and appearance.

Insert the rectangle or ellipse by clicking the corresponding icon in the plot edit toolbar



or by selecting **Rectangle** or **Ellipse** from the **Insert** menu. MATLAB changes the cursor to a cross indicating you can click down, drag, and release the left mouse button to define the size and shape of the object.

Pinning Rectangles and Ellipses

You can attach the rectangle to a particular point in the figure by pinning it to that point. There are three ways to pin the rectangle:

- Right-click on the rectangle to display its context menu.
- Select the pin icon in the figure toolbar (see “Pinning — Attaching to a Point in the Figure” on page 3-16).
- Select **Pin Object** from the **Edit** menu.

By default, pinning attaches the lower left corner of the rectangle or ellipse to its current location in the axes data units. You can move the point of attachment by clicking on the corner and dragging the anchor to another point. The cursor changes to a pin while you are dragging.

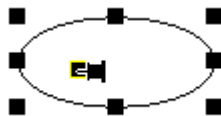

Note that you cannot drag or resize a rectangle or an ellipse when it is pinned.

Modifying the Rectangle or Ellipse from the Context Menu

Right-click on the rectangle or ellipse to display its context menu.

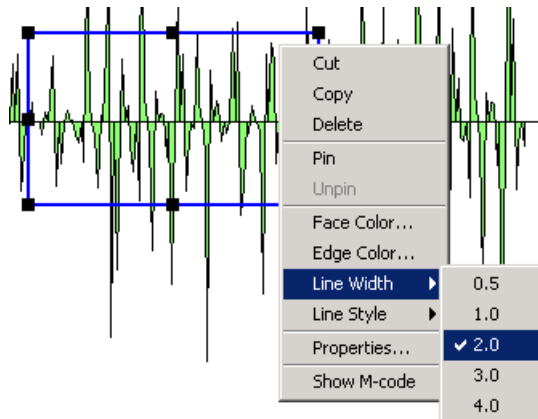

The menu contains the following options:

- **Cut, Copy, Delete** — Cut to clipboard, copy to clipboard, or delete the selected object.
- **Pin to axes** — Pin the lower left corner to the current location (you can move the point of attachment by clicking and dragging the point while in plot edit mode).
- **Unpin** — Detach the rectangle from the attachment point.
- **Face Color** — Fill color for the rectangle or ellipse
- **Edge Color** — Color of the line used to draw the rectangle or ellipse
- **Line Width** — Width of the line used to draw the rectangle or ellipse
- **Line Style** — Type of line used to draw the rectangle or ellipse
- **Properties** — Display the Property Editor with textbox properties.
- **Show M-code** — Create M-code that recreates the graph.

Setting Rectangle and Ellipse Properties

You can use the Property Editor to set rectangle and ellipse properties by selecting **Properties** from the context menu. The Property Editor displays the same properties that are described above in the context menu section.

You can click the **Inspector** button on the Property Editor to display the Property Inspector. The Property Inspector displays all properties for the selected annotation object. However, you should not change some of these

properties because doing so can affect the proper functioning of the annotation object. See the following sections for descriptions of the properties you can change on the respective objects.

- Annotation Rectangle Properties
- Annotation Ellipse Properties

Textbox Annotations

A textbox is a rectangle that can contain multiline text. You can attach the textbox to any point in the figure.

Insert a textbox by clicking the textbox icon in the figure toolbar , then click where you want to place the text string. You can resize the textbox after typing the text or click and drag the box when you create it.

You can also select **TextBox** from the **Insert** menu.

Selecting Textbox Objects

The selection behavior of the textbox object differs from other annotation objects.

- To move a textbox, click once on the text to select it.
- To edit the a textbox, double click within the box.
- To display the Property Editor with textbox properties, right-click to display the context menu and select **Properties**.

Pinning the Textbox

You can attach the textbox to a particular point in the figure by pinning it to that point. There are three ways to pin the textbox:

- Right-click within the textbox to display its context menu.
- Select the pin icon in the figure toolbar (See “Pinning — Attaching to a Point in the Figure” on page 3-16).
- Select **Pin Object** from the **Edit** menu.

By default, pinning attaches the lower left corner of the textbox to its location in the axes data space. You can move the point of attachment by clicking on the corner and dragging the anchor to another point. The cursor changes to the pin while dragging.

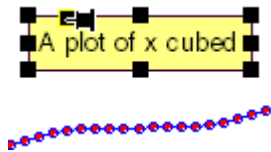

Note that you cannot drag the textbox when it is pinned.

Modifying the Textbox from the Context Menu

Right-clicking in a textbox displays its context menu, which enables you to perform a number of operations on the textbox. In the following picture, the textbox **Background Color** has been set to yellow using the context menu.

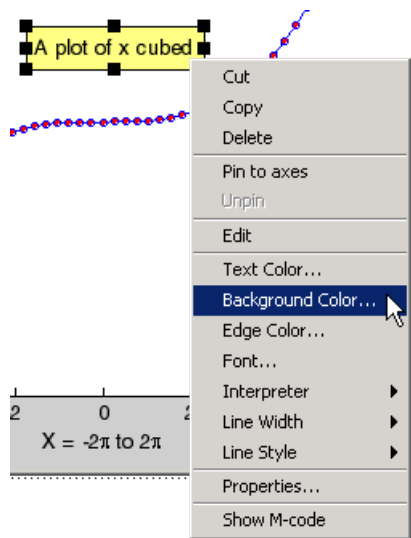

The menu contains the following options:

- **Cut, Copy, Delete** — Cut to clipboard, copy to clipboard, or delete the textbox.
- **Pin to axes** — Pin the textbox to the current location (you can move the point of attachment by clicking and dragging the point while in plot edit mode).
- **Unpin** — Detach the textbox from the attachment point.

- **Edit** — Enable edit mode to change the text. You can also double-click the textbox with the left mouse button to enable edit mode.
- **Text Color** — Color of the text characters
- **Background Color** — Fill color of the rectangle enclosing the text
- **Edge Color** — Color of the textbox edge line (you must set **Line Style** to a value other than none to display edges)
- **Font** — Type of font used for the text
- **Interpreter** — Interpret characters as T_EX (latex or tex) or as literal characters (none).
- **Line Width** — Width of the textbox edge line
- **Line Style** — Style of line used for the textbox edge
- **Properties** — Display the Property Editor with textbox properties.
- **Show M-code** — Create M-code that recreates the graph.

Setting Textbox Properties

You can use the Property Editor to set textbox properties by selecting **Properties** from the textbox context menu. It displays the same properties that are described above in the context menu section.

You can click the **Inspector** button on the Property Editor to display the Property Inspector. The Property Inspector displays all textbox properties. However, you should not change some of these properties because doing so can affect the proper functioning of the textbox.

See “Textbox Properties” in the reference documentation for a description of the properties you can change.

Annotation Lines and Arrows

You can add lines and three types of arrows to a graph and attach them to any point in the figure. The three types of arrows include

- Single-headed arrow
- Arrow with attached text box
- Double-headed arrow

Insert a line or arrow by clicking the appropriate icon in the figure toolbar, then



click down, drag the line or arrow to the desired point, and release the mouse. The arrowhead appears at the terminal end.

With the line or arrow selected, right-click to display the context menu, which provides access to a number of options.

Inserting a Text Arrow

A text arrow combines a textbox with an arrow. It is useful for labeling points on a graph. Add a text arrow to a graph by selecting the arrow icon that has a T above the arrow. Insert the text arrow and type text in the box.



Pinning the Arrowhead End

You can attach the arrowhead end to the point of interest on the graph while letting the text box automatically reposition itself as you zoom or pan the graph.

There are three ways to pin annotations:

- Right-click on the object to display its context menu and select **Pin**.
- Select the pin icon in the plot edit toolbar (See “Pinning — Attaching to a Point in the Figure” on page 3-16).
- Select **Pin Object** from the **Edit** menu.

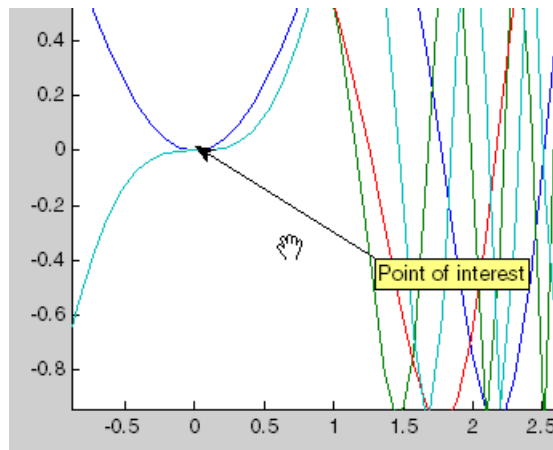

You can pin the arrowhead and then pan the graph to get the desired view.

Modifying the Text Arrow from the Context Menu

Right-clicking on a text arrow displays its context menu, which enables you to perform a number of operations on the text arrow. The context menus for lines, arrows, and double arrows contain similar items:

- **Cut, Copy, Delete** — Cut to clipboard, copy to clipboard, or delete the textbox.
- **Pin to axes** — Pin the textbox to the current location (you can move the point of attachment by clicking and dragging the point while in plot edit mode).
- **Unpin** — Detach the textbox from the attachment point.
- **Reverse Direction** — Swap the arrow head and the textbox or move the arrowhead to the other end of a plain arrow.
- **Edit Text** — Enable edit mode to change the text characters.
- **Color** — Color of the text characters, textbox edge, and arrow
- **Text Background Color** — Color of the rectangle enclosing the text
- **Font** — Type of font used for the text
- **Line Width** — Width of the textbox edge line
- **Line Style** — Style of line used for the textbox edge
- **Head Style** — Type of arrowhead to use
- **Head Size** — Size of the arrowhead in points

- **Properties** — Display the Property Editor with textbox properties.
- **Show M-code** — Create M-code that recreates the graph.

For example, the following illustration shows the text border enabled and the text background color set to yellow.

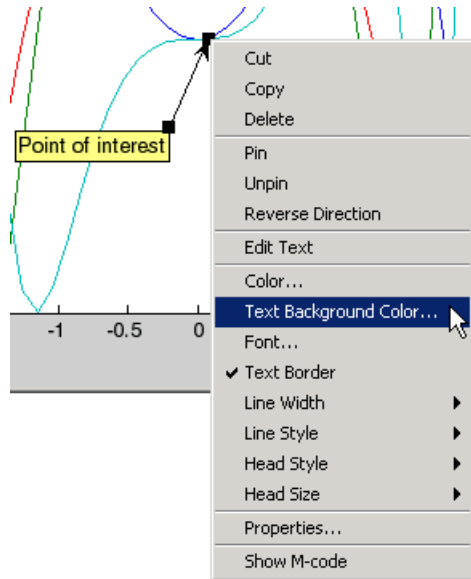

Setting Line and Arrow Properties

You can use the Property Editor to set line and arrow properties by selecting **Properties** from the context menu. The Property Editor displays the same properties that are described above in the context menu section.

You can click the **Inspector** button on the Property Editor to display the Property Inspector. The Property Inspector displays all properties for the selected annotation object. However, you should not change some of these properties, because doing so can affect the proper functioning of the annotation. See the following sections in the reference documentation for descriptions of the properties you can change on the respective objects.

- Annotation Line Properties
- Annotation Arrow Properties

- Annotation Textarrow Properties
- Annotation Doublearrow Properties

Adding a Colorbar to a Graph

Colorbars display the current colormap and indicate the mapping from data values to colors. The following picture shows a surface plot with 2-D contour lines below. Note how the colorbar at the right indicates how the z -axis data values correspond to colors in both the surface and contour graphs.

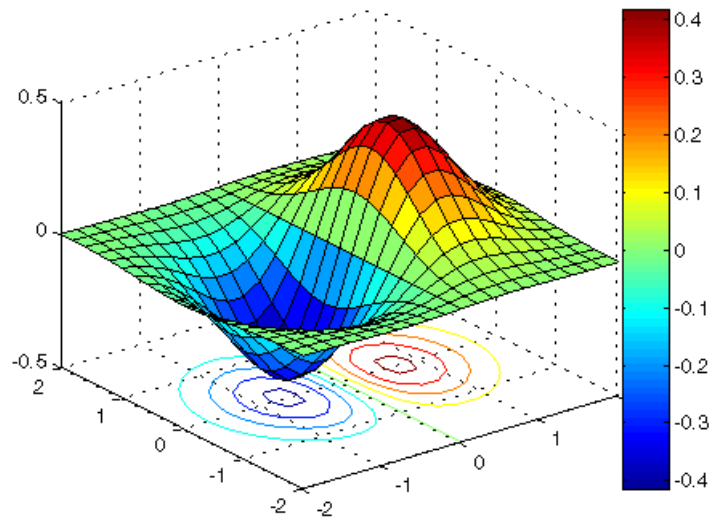

Add a colorbar by clicking the colorbar icon in the toolbar  or by selecting **Colorbar** from the **Insert** menu. When plot editing is enabled, you can select and then move and resize the colorbar.

You can also use the colorbar command to add a colorbar to a graph.

Positioning Options for Colorbars

There are a variety of ways to reposition a colorbar in the figure.

- Enable plot edit mode, then select and drag the colorbar to the desired location.

- Right-click over the colorbar to display its context menu. Mouse over **Locations** and select one of the predefined locations for the colorbar.
- Right-click over the colorbar to display its context menu and select **Properties**. This displays the Property Editor, which provides a graphical positioning device for the colorbar.

Selecting a Different Colormap

If you change the figure colormap, the colorbar updates automatically. Use one of the following methods to change the colormap.

- Right-click over the colorbar to display its context menu. Mouse over **Standard Colormaps** and select from the displayed list.
- Right-click over the colorbar to display its context menu and select **Properties**. Click on the figure background to load the figure properties into the Property Editor. Select the colormap from the pull-down list.
- Use the colormap command.

Modifying the Colormap

You can use a colorbar to modify the current colormap. To do this, select **Interactive Colormap Shift** from the right-click context menu. In this mode, you can left-click down on any color in the colorbar and, by dragging the mouse, shift the color-to-data mapping.

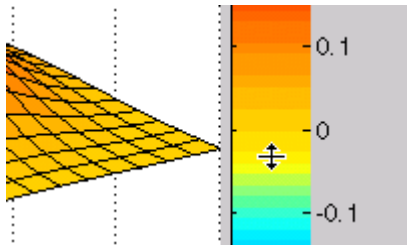

To perform more sophisticated operations on the colormap, launch the colormap editor by selecting **Launch Colormap Editor** from the colorbar's context menu. See the colormapeditor reference page for more information.

Adding a Legend to a Graph

Legends provide a key to the various data plotted on a graph. The following picture shows the legend for a graph of four functions of a variable plotted with lines of different colors. Note how you can assign an appropriate string to each line in the legend.

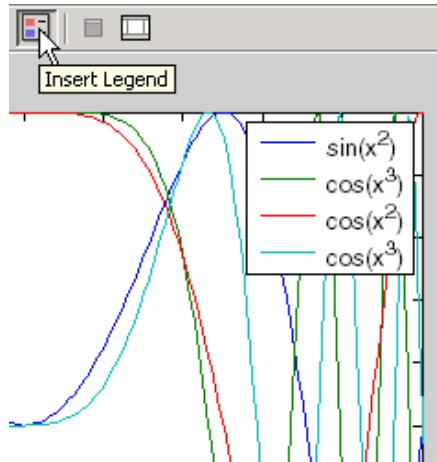

Add a legend by clicking the legend icon in the toolbar  or by selecting **Legend** from the **Insert** menu. When plot editing is enabled, you can select and then move and resize the legend.

You can also use the legend command to add a legend to a graph.

Specifying the Text

By default, the legend labels each plotted object (line, surface, etc.) with the strings data1, data2, etc. You can change this text by double-clicking on the text to enable edit mode. In edit mode, you can retype the text string.

You can use $\text{T}_\text{E}\text{X}$ characters in the text strings to produce symbols. You can disable interpretation of characters as $\text{T}_\text{E}\text{X}$ sequences by selecting **none** from the **Interpreter** submenu of the legend's right-click context menu.

See the the Table of $\text{T}_\text{E}\text{X}$ symbols in the Text Properties reference documentation for more information.

Positioning the Legend

There are a number of ways to position the legend.

- Enable plot edit mode, select the legend, and drag it to the desired location.
- Right-click on the legend to display its context menu, mouse over **Location**, and select one of the predefined locations from the submenu.
- Right-click on the legend to display its context menu and select **Properties** to display the Property Editor, which provides a graphical device for positioning the legend.

You can also select a vertical or horizontal orientation for the legend. Use the **Orientation** item in the context menu to make this selection.

Changing the Appearance of the Legend

You can specify the following legend characteristics from the context menu:

- **Color** — Set the background color of the legend.
- **Edge Color** — Set the color of the line enclosing the legend box.
- **Line Width** — Set the width of the edge line.
- **Font** — Set the font, font style, and font size of the text used in the legend.
- **Interpreter** — Set the text Interpreter property to use $T_{E}X$ or plain text.
- **Orientation** — Orient the legend entries side by side (horizontal) or on top of each other.
- **Properties** — Display the Property Editor with legend properties.
- **Show M-code** — Generates M-Code for recreating the legend.

Pinning – Attaching to a Point in the Figure

Pinning is the attachment of an object to a particular point in the figure. Pinning enables you to pan or resize the figure while keeping annotations associated with the same point. For example, the following picture shows regions in two different graphs associated by pinning both ends of a double arrow.

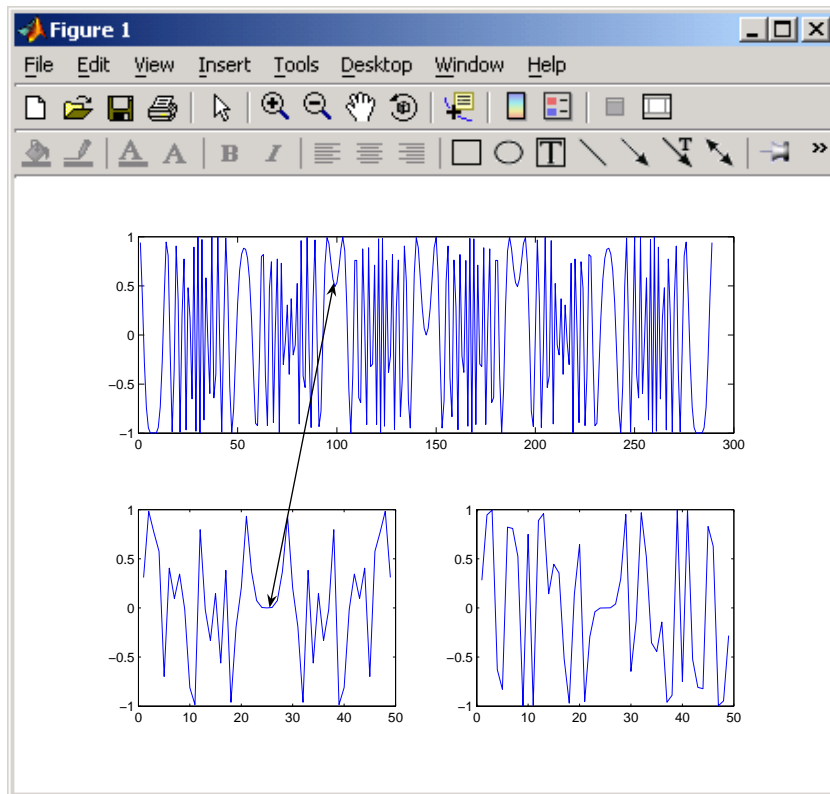

If you perform a horizontal zoom on the top axes (select **Horizontal Zoom** from the **Options** submenu of the **Tools** menu) and then pan the graph to show the first 120 seconds of the data, the double arrow continues to point to the same locations on the graph.

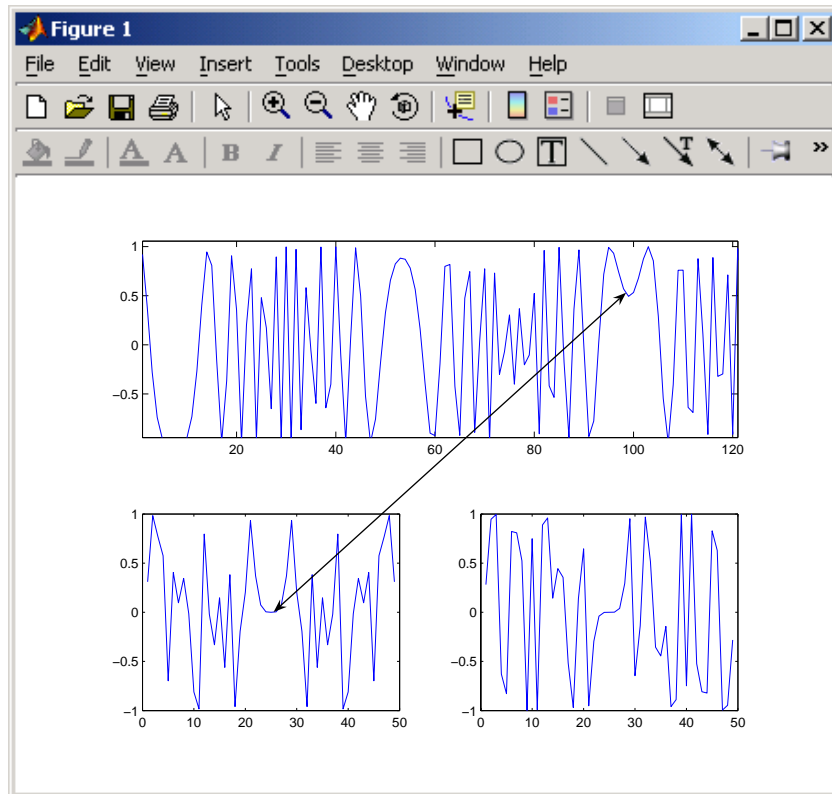

Pinning Objects

To pin an object, first enable pinning mode by clicking the pin object icon  in the plot edit toolbar or select **Pin Object** from the **Edit** menu. Then click the point you want to pin.

To unpin an object, right-click to display the context menu and select **Unpin**.

You can pin annotation lines, arrows, rectangles, ellipses, and textboxes.

When this mode is enabled, axes, rectangle, arrows, and lines automatically align their upper left corners to the grid. As you move or resize one of these objects, the size or position snaps to the next grid location.

Alignment Tool — Aligning and Distributing Objects

The Alignment Tool enables you to position objects with respect to each other and to adjust the spacing between selected objects. The specified align/distribute operations apply to all components that are selected when you click the **Apply** or **OK** buttons.

Display the Alignment Tool by clicking the Align/Distribute icon  or by selecting **Align Distribute Tool** from the **Tools** menu.

Alignment Tool Functionality

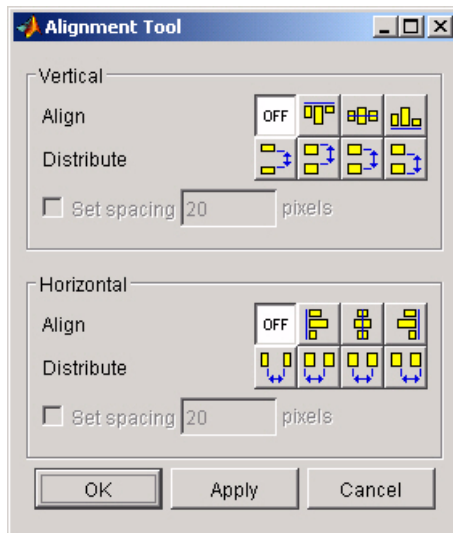

The Alignment Tool provides two types of positioning operations:

- **Align** — Align all selected objects to a single reference line.
- **Distribute** — Space all selected objects uniformly with respect to each other.

You can align and distribute objects in the vertical and horizontal directions. The following sections provide more information.

- “Example — Vertical Distribute, Horizontal Align” on page 3-20
- “Align/Distribute Menu Options” on page 3-22

- “Snap to Grid — Aligning Objects on a Grid” on page 3-24

Example — Vertical Distribute, Horizontal Align

This example illustrates how to align three textboxes with three corresponding axes. In this example, the text boxes were just plunked down close to the desired position and then right aligned and distributed to have 40 pixels between them.

The following picture shows the initial layout.

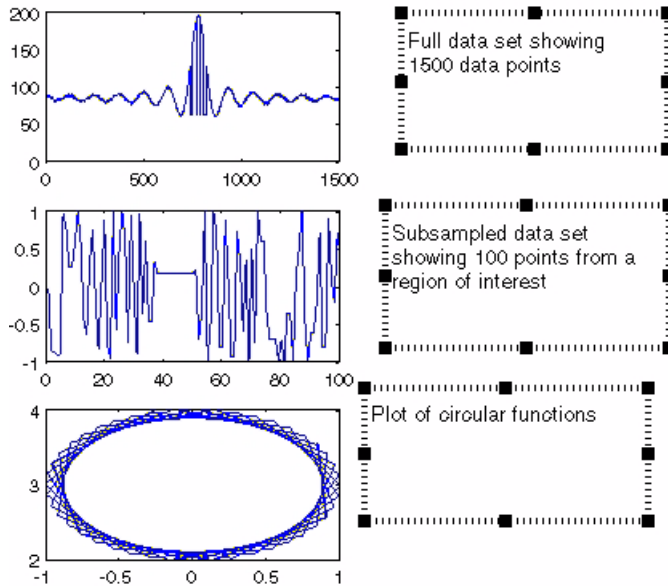

Use **Shift+click** to select all three textboxes and then configure the Alignment Tool as shown in the following picture.

- Set vertical distribution to 40 pixels.
- Set horizontal alignment to right-aligned.
- Click **Apply**.

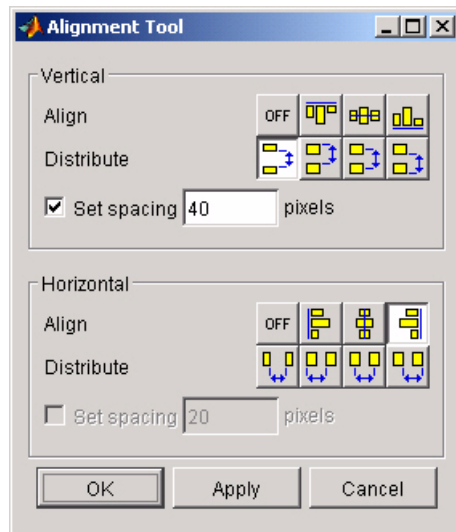

The following picture shows the result.

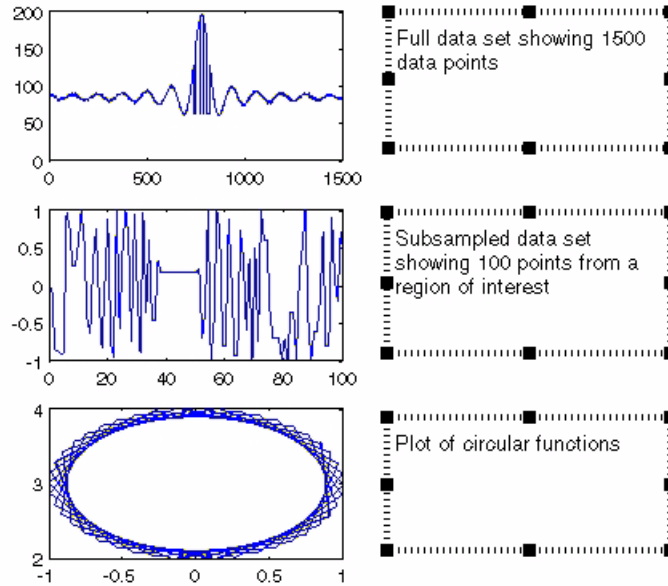

Align/Distribute Menu Options

The **Tools** menu contains the alignment and distribution options that are available via the Alignment Tool.

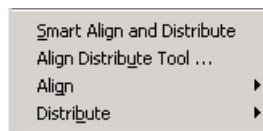

The **Smart Align and Distribute** option aligns objects into rows and columns with equal spacing between each object. It is useful when you have a number of objects to align that can be positioned in an m-by-n grid.

For example, the following figure contains six axes that have been placed approximately into two columns in the figure.

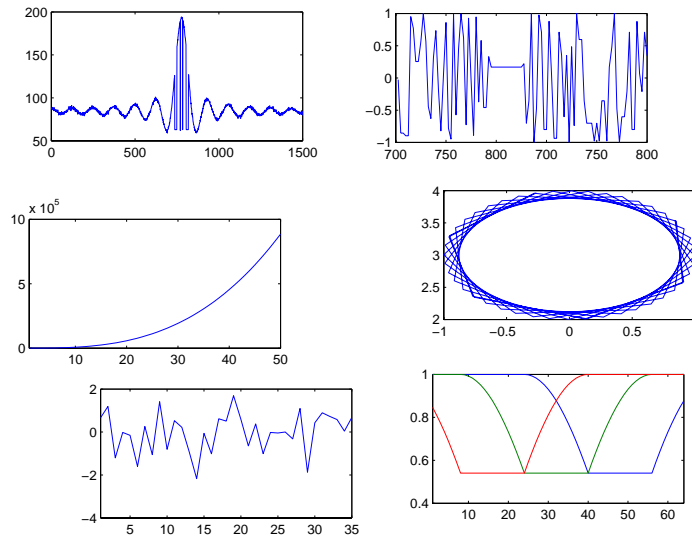

To align all axes in a grid, select each axes (**Shift+click** on each one), then select **Smart Align and Distribute** from the **Tools** menu. The resulting alignment and distribution of the axes are shown below.

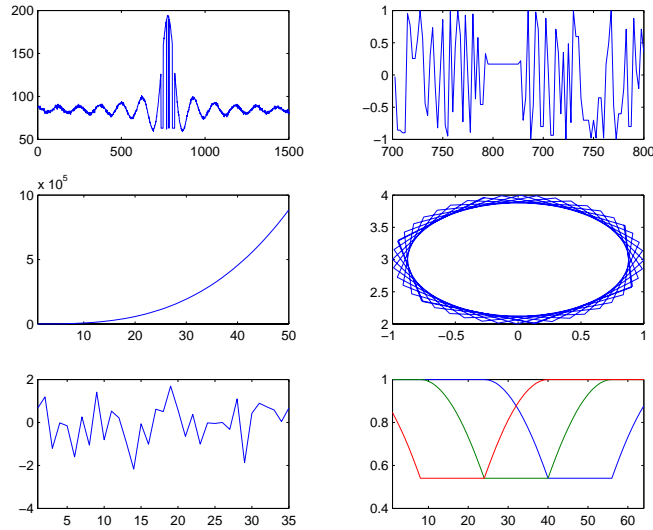

Snap to Grid – Aligning Objects on a Grid

Figures have a layout grid that can aid the hand layout of objects displayed in the figure. You can also enable a snap-to-grid feature that forces objects to align with the grid increments when moved.

To display the grid on the figure background, select **View Layout Grid** from the **Tools** menu.

To force objects to align with the grid, select **Snap To Layout Grid** from the **Tools** menu.

To move objects in the figure, enable Plot Edit mode by selecting **Edit Plot** from the **Tools** menu. Click to select an object and then drag it to the desired location.

The following picture illustrates a figure with four subplots. You can select any of the four axes and move them. Note that all axis labels and the title move with the axes. Annotation objects move independently of the plot axes.

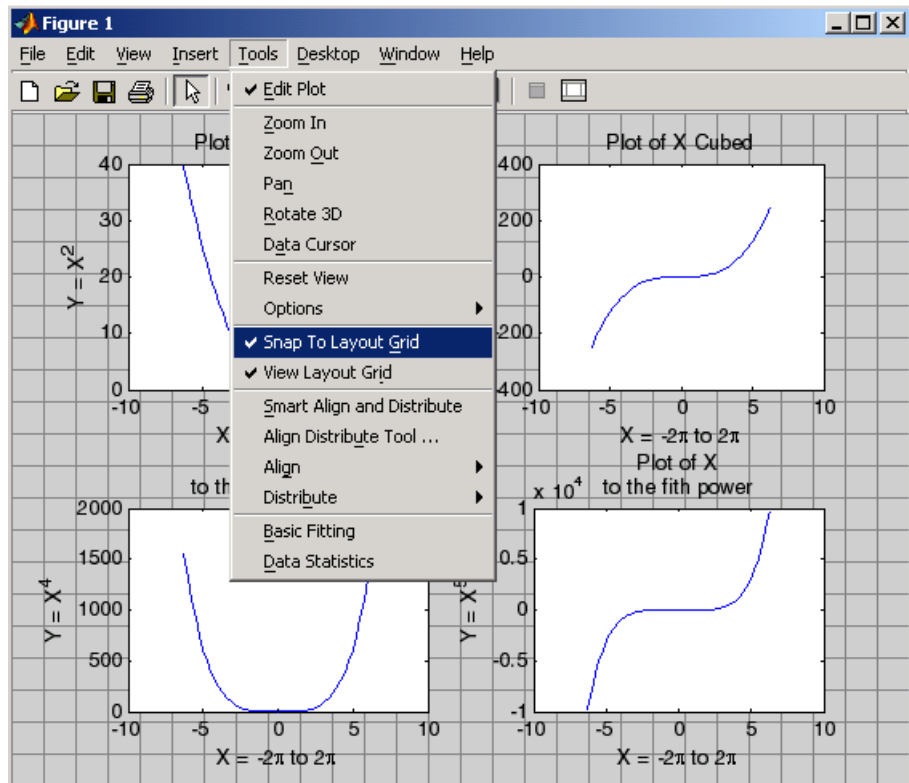

Adding Titles to Graphs

In MATLAB, a title is a text string at the top of an axes. Titles typically define the subject of the graph.

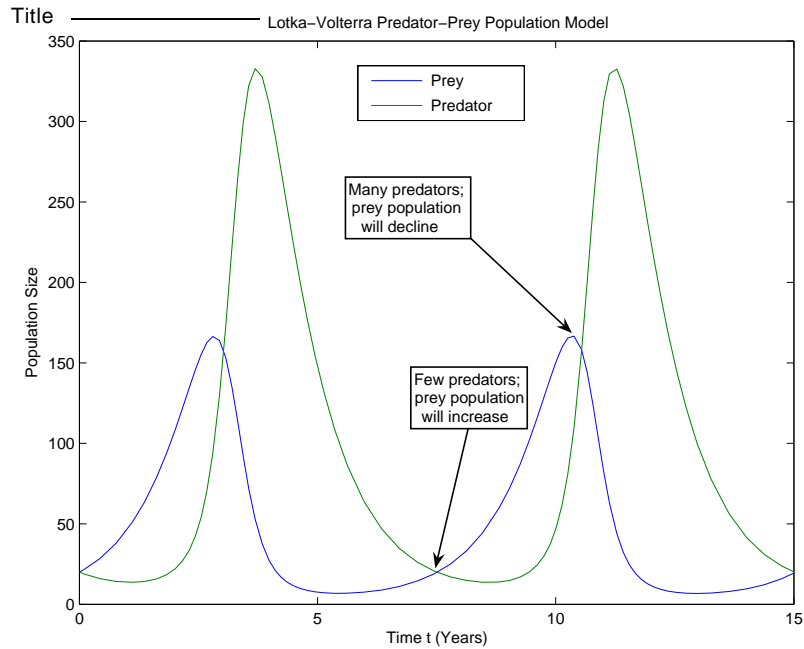

There are several ways to add a title to a graph:

- “Using the Title Option on the Insert Menu” on page 3-27
- “Using the Property Editor to Add a Title” on page 3-27
- “Using the title Function” on page 3-28

Note While you can use text annotations to create a title for your graph, it is not recommended. Titles are anchored to the top of the axes they describe; text annotations are not. If you move or resize your axes, the title remains at the top. Additionally, if you cut a title and then paste it back into a figure, the title is no longer anchored to the axes.

Using the Title Option on the Insert Menu

To add a title to a graph using the **Insert** menu,

- 1 Click the **Insert** menu in the figure menu bar and choose **Title**. MATLAB opens a text entry box at the top of the axes.

Note When you select the **Title** option, MATLAB enables plot editing mode automatically.

- 2 Enter the text of the label.
- 3 When you are finished entering text, click anywhere in the figure background to close the text entry box around the title. If you click on another object in the figure, such as an axes or line, you close the title text entry box and also automatically select the object you clicked.

To change the font used in the title to bold, you must edit the title. You can edit the title as you would any other text object in a graph.

Using the Property Editor to Add a Title

To add a title to a graph using the Property Editor,

- 1 Start plot editing mode by selecting **Edit Plot** from the figure **Tools** menu.
- 2 Double-click on an empty region of the axes in the graph. This starts the Property Editor. You can also start the Property Editor by right-clicking on

the axes and selecting **Properties** from the context menu or by selecting **Property Editor** from the **View** menu.

The Property Editor displays a property panel specific to axes objects. Titles are a property of axes objects.

- 3 Type the text of your title in the **Title** text entry box.

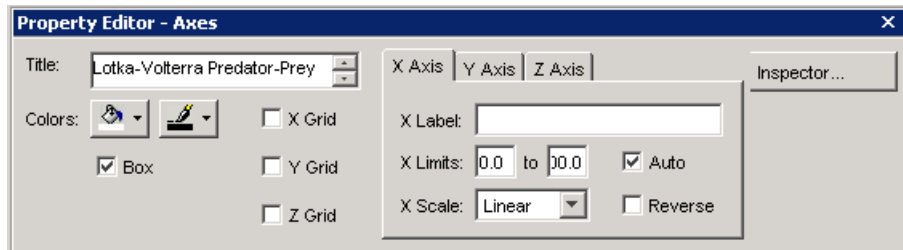

You can change the font, font style, position, and many other aspects of the title format.

- To move the title, select the text and drag it to the desired position.
- To edit the text, double-click the title and type new characters.
- To change the font and other text properties, select the title and right-click to display the context menu.

Using the title Function

To add a title to a graph at the MATLAB command prompt or from an M-file, use the `title` function.

For example, the following code adds a title to the current axes and sets the value of the `FontWeight` property to bold.

```
title('Lotka-Volterra Predator-Prey Population Model',...  
      'FontWeight','bold')
```

To edit a title from the MATLAB command prompt or from an M-file, use the `set` function.

Adding Axis Labels to Graphs

In MATLAB, an axis label is a text string aligned with the x -, y -, or z -axis in a graph. Axis labels can help explain the meaning of the units that each axis represents.

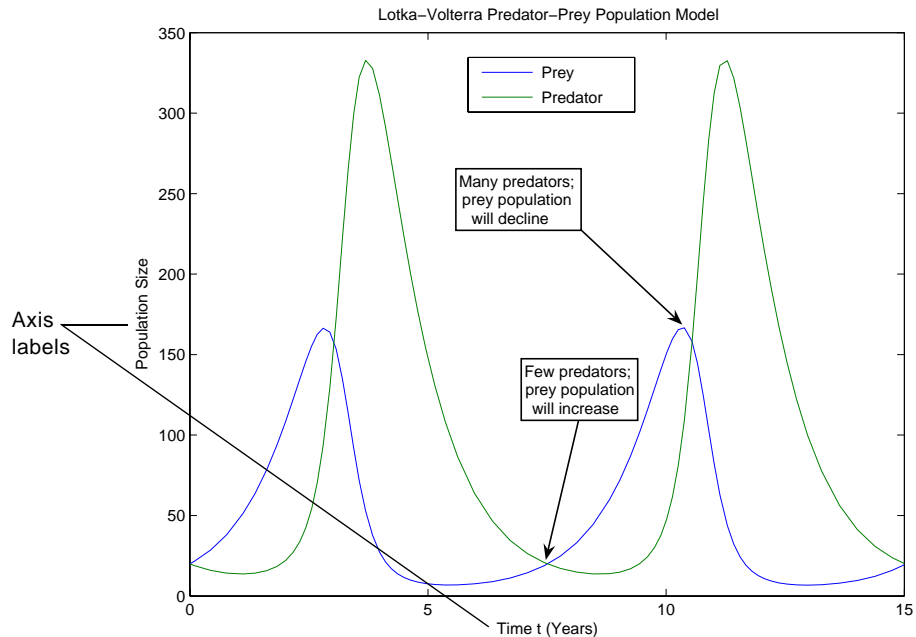

Note While you can use freeform text annotations to create axes labels, it is not recommended. Axis labels are anchored to the axes they describe; text annotations are not. If you move or resize your axes, the labels automatically move with the axes. Additionally, if you cut a label and then paste it back into a figure, the label is no longer anchored to the axes.

To add axis labels to a graph, you can use any of these mechanisms:

- “Using the Label Options on the Insert Menu” on page 3-30

- “Using the Property Editor to Add Axis Labels” on page 3-30
- “Using Axis-Label Commands” on page 3-32

Using the Label Options on the Insert Menu

- 1 Click the **Insert** menu and choose the label option that corresponds to the axis you want to label: **X Label**, **Y Label**, or **Z Label**. MATLAB opens a text entry box along the axis or around an existing axis label.

Note MATLAB opens up a horizontal text editing box for the y - and z -axis labels and automatically rotates the label into alignment with the axis when you finish entering text.

- 2 Enter the text of the label, or edit the text of an existing label.
- 3 Click anywhere else in the figure background to close the text entry box around the label. If you click on another object in the figure, such as an axes or line, you close the label text entry box but also automatically select the object you clicked.

Note After you use the **Insert** menu to add an axis label, plot edit mode is enabled in the figure, if it was not already enabled.

Using the Property Editor to Add Axis Labels

To add labels to a graph using the Property Editor,

- 1 Start plot editing mode by selecting **Edit Plot** from the figure **Tools** menu.
- 2 Start the Property Editor by double-clicking on the axes in the graph. You can also start the Property Editor by right-clicking on the axes and selecting

Properties from the context menu or by selecting **Property Editor** from the **View** menu.

The Property Editor displays the set of property panels specific to axes objects.

- 3 Select the **X Axis**, **Y Axis**, or **Z Axis** panel, depending on which axis label you want to add. Enter the label text in the text entry box.

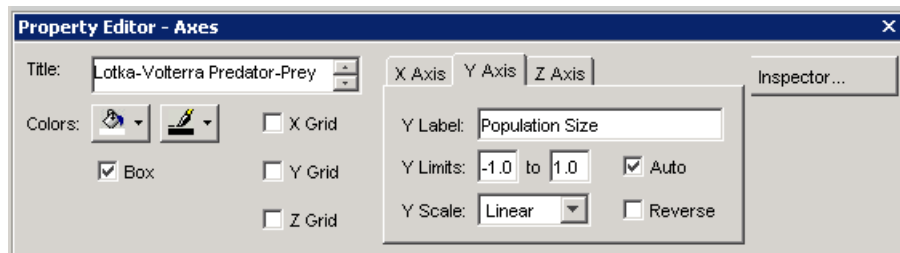

Rotating Axis Labels

You can rotate axis labels using the Property Editor:

- 1 Start plot editing mode by selecting **Edit Plot** from the figure **Tools** menu.
- 2 Display the Property Editor by selecting (left-clicking) the axis label you want to rotate. Right-click over the selected text, then choose **Properties** from the context menu.
- 3 Click the **Inspector** button to display the Property Inspector.

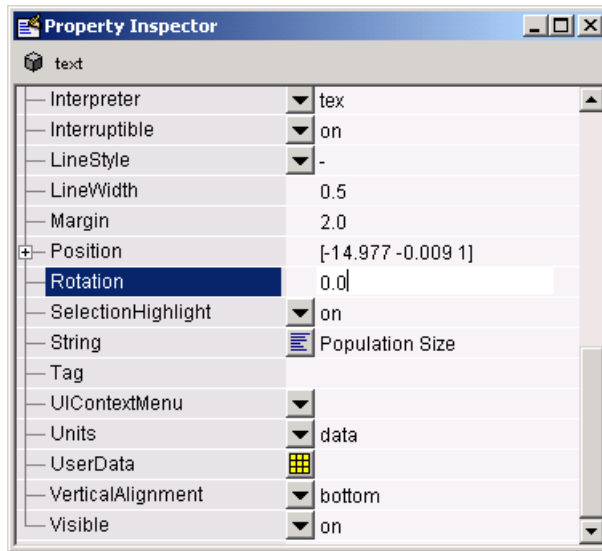

- 4 Select the **Rotation** property text field. A value of 0 degrees orients the label in the horizontal position.
- 5 With the left mouse button down on the selected label, drag the text to the desired location and release.

Using Axis-Label Commands

You can add x -, y -, and z -axis labels using the `xlabel`, `ylabel`, and `zlabel` commands. For example, these statements label the axes and add a title.

```
xlabel('t = 0 to 2\pi','FontSize',16)
ylabel('sin(t)','FontSize',16)
title('\it{Value of the Sine from Zero to Two Pi}','FontSize',16)
```

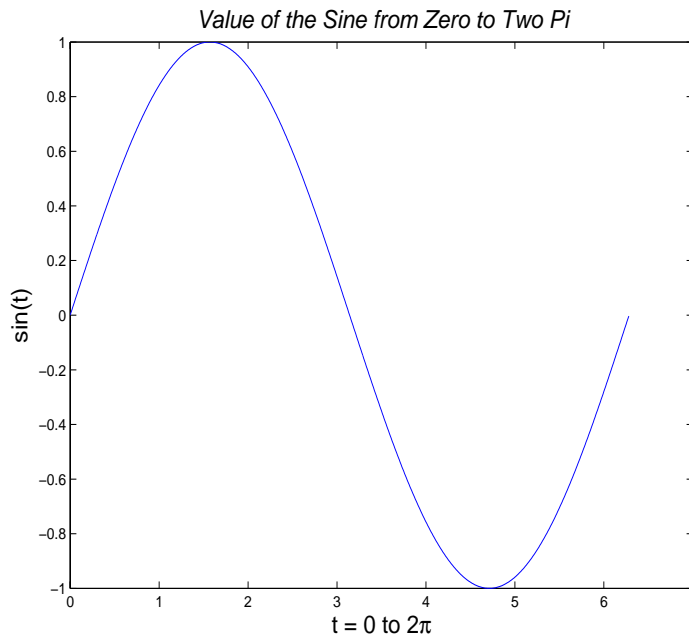
The labeling commands automatically position the text string appropriately. MATLAB interprets the characters immediately following the backslash (`\`) as TeX commands. These commands draw symbols such as Greek letters and arrows.

See the text `String` property for a list of TeX character sequences. See also the `textlabel` function for converting MATLAB expressions to TeX symbols.

Rotating Axis Labels Using Commands

Axis labels are text objects that you can rotate by specifying a value for the object's `Rotation` property. The handles of the x -, y -, and z -axis labels are stored in the axes `XLabel`, `YLabel`, and `ZLabel` properties respectively.

Therefore, to rotate the y -axis label so that the text is horizontal:

- 1 Get the handle of the text object using the axes `YLabel` property.
- 2 Set the `Rotation` property to 0.0 degrees.

For example, this statement rotates the text of the y -axis label on the current axes:

```
set(get(gca, 'YLabel'), 'Rotation', 0.0)
```

Repositioning Axis Labels

You can reposition an axis label by dragging the text.

- 1 Start plot editing mode by selecting **Edit Plot** from the figure **Tools** menu.
- 2 Select the text of the label you want to reposition (handles appear around the text object).
- 3 With the left mouse button down on the selected label, drag the text to the desired location and release.

Adding Text Annotations to Graphs

You can add freeform text annotations anywhere in a MATLAB figure to help explain your data or bring attention to specific points in your data sets.

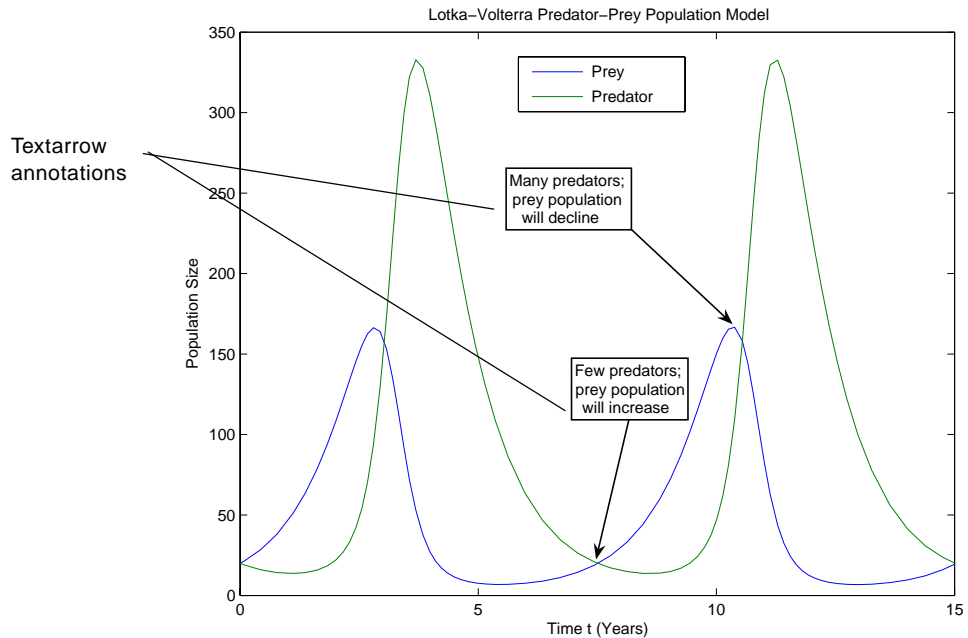

If you enable plot editing mode, you can create text annotations by clicking in an area of the graph or the figure background and entering text. You can also add text annotations from the command line, using the `text` or `gtext` command.

Using plot editing mode or `gtext` makes it easy to place a text annotation anywhere in a graph. Use the `text` command when you want to position a text annotation at a specific point in a data set.

Note Text annotations created using the `text` or `gtext` command are anchored to the axes. Text annotations created in plot edit mode are not. If you move or resize your axes, you will have to reposition your text annotations.

Creating Text Annotations with the `text` or `gtext` Command

To create a text annotation using the `text` function, you must specify the text and its location in the graph, using x - and y -coordinates. You specify the coordinates in the units of the graph.

Use the `gtext` command when you want to position a text annotation at a specific point in the data space with the mouse.

For example, the following code creates text annotations at specific points in the Lotka-Volterra Predator-Prey Population Model graph.

```
str1(1) = {'Many Predators;'};
str1(2) = {'Prey Population'};
str1(3) = {'Will Decline'};
text(7,220,str1)
```

```
str2(1) = {'Few Predators;'};
str2(2) = {'Prey Population'};
str2(3) = {'Will Increase'};
text(5.5,125,str2)
```

This example also illustrates how to create multiline text annotations with cell arrays.

Calculating the Positions of Text Annotations

You can also calculate the positions of text annotations in a graph. The following code adds annotations at three data points on a graph.

```
text(3*pi/4,sin(3*pi/4),...
    '\leftarrowsin(t) = .707',...
    'FontSize',16)

text(pi,sin(pi),'\leftarrowsin(t) = 0',...
```

```

        'FontSize',16)

text(5*pi/4,sin(5*pi/4),'sin(t) = -.707\rightarrow',...
     'HorizontalAlignment','right',...
     'FontSize',16)

```

The `HorizontalAlignment` of the text string `'sin(t) = -.707 \rightarrow'` is set to `right` to place it on the left side of the point $[5\pi/4, \sin(5\pi/4)]$ on the graph. For more information about aligning text annotations, see “Text Alignment” on page 3-39.

Defining Symbols. For information on using symbols in text strings, see “Mathematical Symbols, Greek Letters, and TEX Characters” on page 3-42.

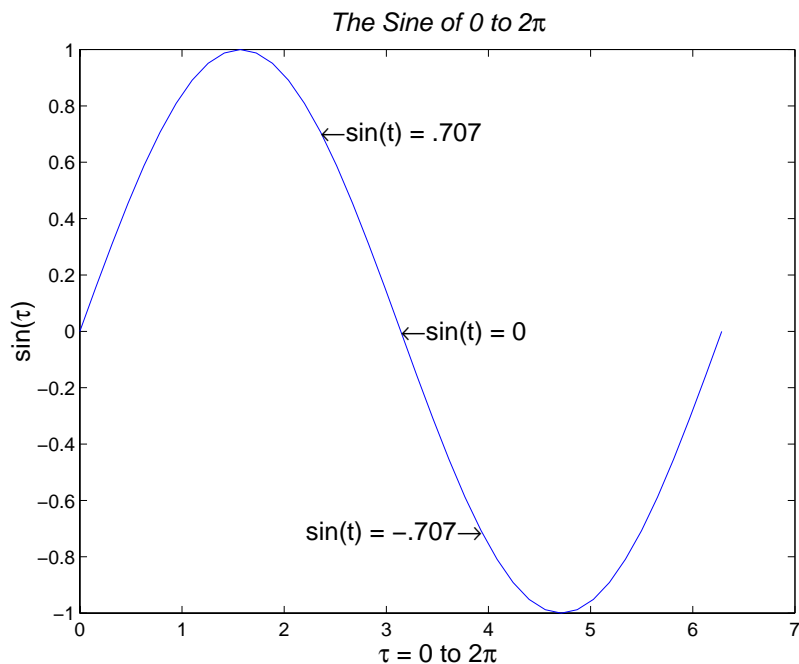

You can use text objects to annotate axes at arbitrary locations. MATLAB locates text in the data units of the axes. For example, suppose you plot the function $y = Ae^{-\alpha t}$ with $A = 0.25$, $\alpha = 0.005$, and $t = 0$ to 900.

```
t = 0:900;
plot(t,0.25*exp(-0.005*t))
```

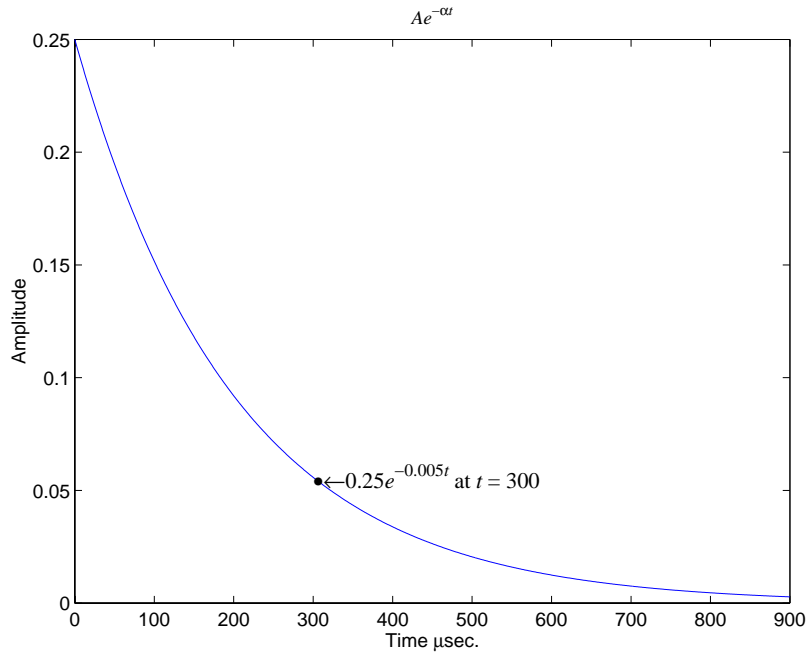

To annotate the point where the value of $t = 300$, calculate the text coordinates using the function you are plotting.

```
text(300, .25*exp(-0.005*300), ...
'\bullet\leftarrow\fontname{times}0.25{\ite}^{-0.005{\itt}} at {\itt} =
300', ...
'FontSize',14)
```

This statement defines the text Position property as

$$x = 300, \quad y = 0.25e^{-0.005t}$$

The default text alignment places this point to the left of the string and centered vertically with the rectangle defined by the text Extent property. The following section provides more information about changing the default text alignment.

Text Alignment

The `HorizontalAlignment` and the `VerticalAlignment` properties control the placement of the text characters with respect to the specified x -, y -, and z -coordinates. The following diagram illustrates the options for each property and the corresponding placement of the text.

Text `HorizontalAlignment` property viewed with the `VerticalAlignment` property set to `middle` (the default).

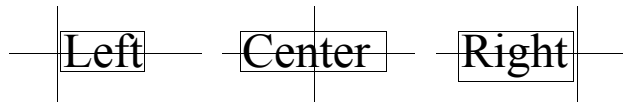

Text `VerticalAlignment` property viewed with the `HorizontalAlignment` property set to `left` (the default).

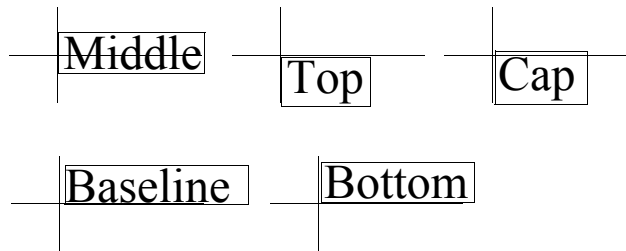

The default alignment is

- `HorizontalAlignment = left`
- `VerticalAlignment = middle`

MATLAB does not place the text `String` exactly on the specified `Position`. For example, the previous section showed a plot with a point annotated with text. Zooming in on the plot enables you to see the actual positioning of the text.

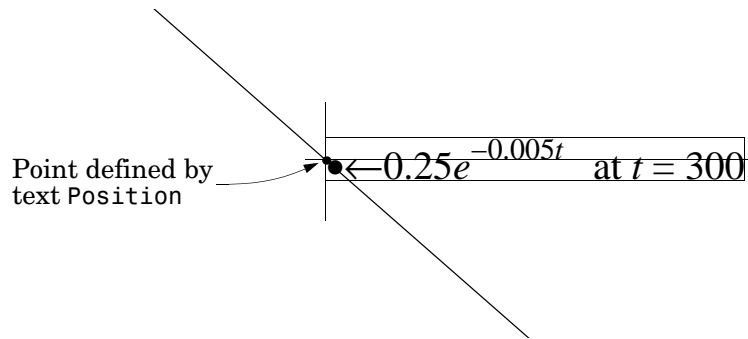

The small dot is the point specified by the text `Position` property. The larger dot is the bullet defined as the first character in the text `String` property.

Example – Aligning Text

Suppose you want to label the minimum and maximum values in a plot with text that is anchored to these points and that displays the actual values. This example uses the plotted data to determine the location of the text and the values to display on the graph. One column from the peaks matrix generates the data to plot.

```
Z = peaks;
h = plot(Z(:,33));
```

The first step is to find the indices of the minimum and maximum values to determine the coordinates needed to position the text at these points (`get`, `find`). Then create the string by concatenating the values with a description of what the values are.

```
x = get(h,'XData'); % Get the plotted data
y = get(h,'YData');
imin = find(min(y) == y); % Find the index of the min and max
imax = find(max(y) == y);
text(x(imin),y(imin),[' Minimum = ',num2str(y(imin))],...
     'VerticalAlignment','middle',...
     'HorizontalAlignment','left',...
     'FontSize',14)
text(x(imax),y(imax),['Maximum = ',num2str(y(imax))],...
     'VerticalAlignment','bottom',...
     'HorizontalAlignment','right',...)
```



```
'FontSize',14)
```

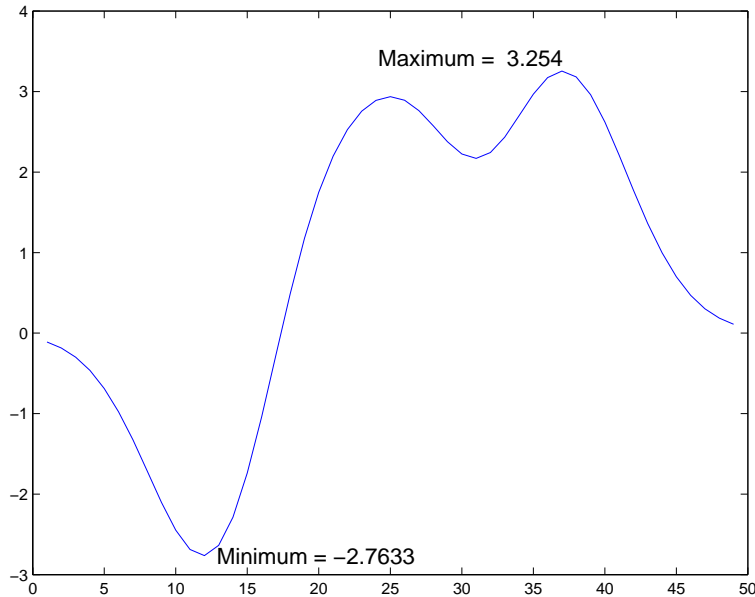

The text function positions the string relative to the point specified by the coordinates, in accordance with the settings of the alignment properties. For the minimum value, the string appears to the right of the text position point; for the maximum value the string appears above and to the left of the text position point. The text always remains in the plane of the computer screen, regardless of the view.

Editing Text Objects

You can edit any of the text labels or annotations in a graph:

- 1 Start plot edit mode.
- 2 Double-click on the string. Or right-click on the string and select **String** from the context menu.

An editing box appears around the text.

- 3 Make any changes to the text.
- 4 Click anywhere outside the text edit box to end text editing.

Note To create special characters in text, such as Greek letters or mathematical symbols, use T_EX sequences. See the text string property for a table of characters you can use. If you create special characters by using the **Edit Font Properties** dialog box and selecting the Symbol font family, you will not be able to edit that text object using MATLAB commands.

Mathematical Symbols, Greek Letters, and T_EX Characters

You can include mathematical symbols and Greek letters in text using T_EX-style character sequences. This section describes how to construct a T_EX character sequence.

Two Levels of T_EX Support

MATLAB provides two levels of T_EX support, controlled by the text Interpreter property.

- `tex` — Support for a subset of T_EX markup
- `latex` — Support T_EX and LaT_EX markup

If you do not want the characters interpreted as T_EX markup, then set the interpreter property to none.

Available Symbols and Greek Letters

For a list of symbols and the character sequences used to define them, see the table of available T_EX characters in the Text Properties reference page.

In general, you can define text that includes symbols and Greek letters using the text function, assigning the character sequence to the String property of text objects. You can also include these character sequences in the string arguments of the `title`, `xlabel`, `ylabel`, and `zlabel` commands.

Example — Using a Mathematical Expression to Title a Graph

This example uses T_EX character sequences to create graph labels. The following statements add a title and x - and y -axis labels to an existing graph.

```
title({'\itAe}^{\-\alpha\itt}sin\beta{\\itt} \alpha<<\beta')
xlabel('Time \musec.')
ylabel('Amplitude')
```

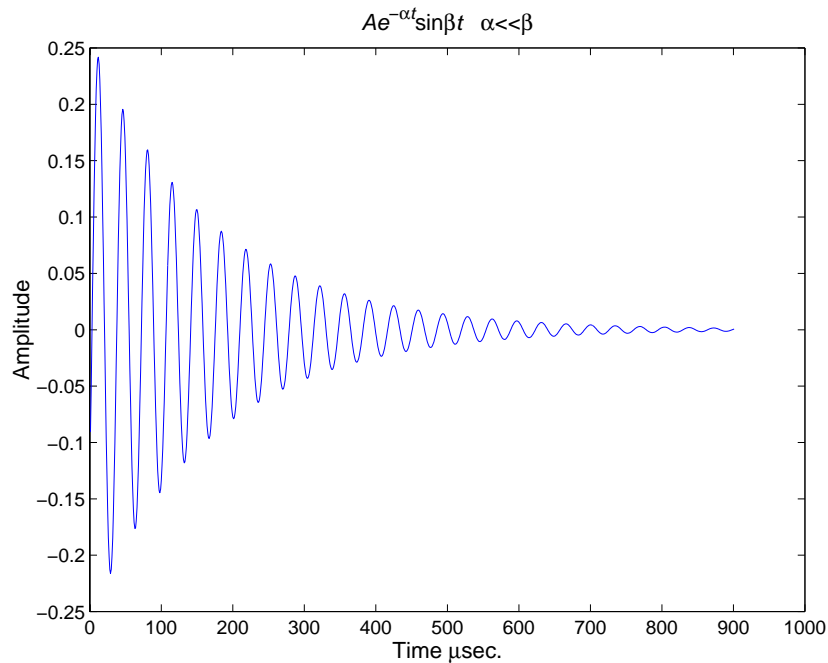

The backslash character (\backslash) precedes all T_EX character sequences. Looking at the string defining the title illustrates how to use these characters.

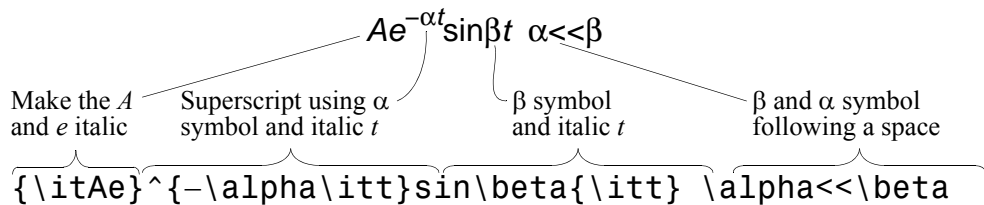

Controlling the Interpretation of T_EX Characters

The text Interpreter property controls the interpretation of T_EX characters. If you set this property to none, MATLAB interprets the special characters literally.

Using Character and Numeric Variables in Text

Any string variable is a valid specification for the text String property. This section illustrates how to use matrix, cell array, and numeric variables as arguments to the text function.

Character Variables

For example, each row of the matrix PersonalData contains specific information about a person (note that all but the longest row are padded with a space so that each has the same number of columns).

```
PersonalData = ['Jack Straw  '; '489 Main St.'; 'Wichita KN  '];
```

To display the data, index into the desired row.

```
text(x1,y1,['Name: ',PersonalData(1,:)])
text(x2,y2,['Address: ',PersonalData(2,:)])
text(x3,y3,['City and State: ',PersonalData(3,:)])
```

Cell Arrays

Using a cell array enables you to create multiline text with a single text object. Each cell does not need to be the same number of characters. For example, the following statements,

```
key(1)={'{\itAe}^{\-\alpha\itt}sin\beta{\itt}'};
key(2)={'Time in \musec'};
key(3)={'Amplitude in volts'};
text(x,y,key)
```

produce this output.

```
Ae-αtsinβt
Time in μsec
Amplitude in volts
```

Numeric Variables

You can specify numeric variables in text strings using the `num2str` (number to string) function. For example, if you type on the command line

```
x = 21;
['Today is the ',num2str(x),'st day.']
```

MATLAB concatenates the three separate strings into one.

```
Today is the 21st day.
```

Since the result is a valid string, you can specify it as a value for the text String property.

```
text(xcoord,ycoord,['Today is the ',num2str(x),'st day.'])
```

Example – Multiline Text

MATLAB supports multiline text strings using cell arrays. Simply define a string variable as a cell array with one line per cell. This example defines two cell arrays, one used for a `uicontrol` and the other as `text`.

```
str1(1) = {'Center each line in the Uicontrol'};
str1(2) = {'Also check out the textwrap function'};

str2(1) = {'Each cell is a quoted string'};
str2(2) = {'You can specify how the string is aligned'};
str2(3) = {'You can use LaTeX symbols like \pi \chi \xi'};
str2(4) = {'\bfOr use bold \rm\itOr italic font\rm'};
str2(5) = {'\fontname{courier}Or even change fonts'};
plot(0:6,sin(0:6))
uicontrol('Style','text','Position',[80 80 200 30],...
         'String',str1);
text(5.75,sin(2.5),str2,'HorizontalAlignment','right')
```

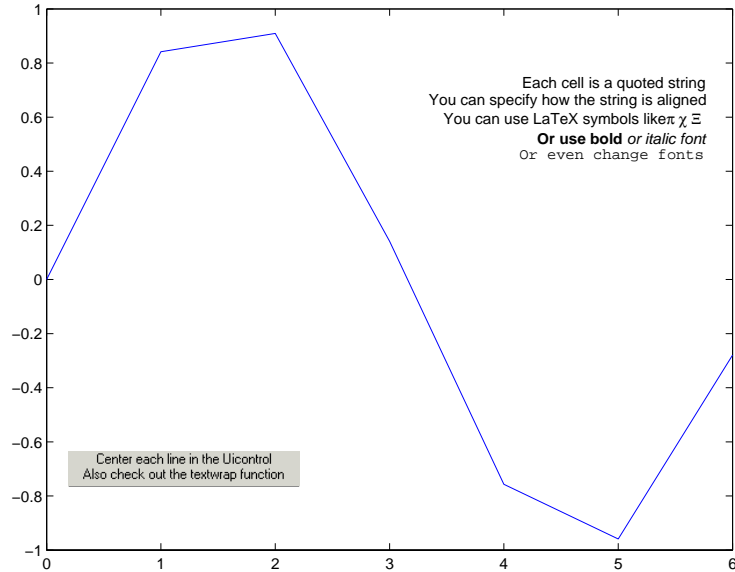

Drawing Text in a Box

When you use the `text` command to display a character string, the string's position is defined by a rectangle called the Extent of the text. You can display this rectangle either as a box or a filled area. For example, you can highlight contour labels to make the text easier to read.

```
[x,y] = meshgrid(-1:.01:1);  
z = x.*exp(-x.^2-y.^2);;  
[c,h]=contour(x,y,z);  
h = clabel(c,h);  
set(h, 'BackgroundColor', [1 1 .6])
```

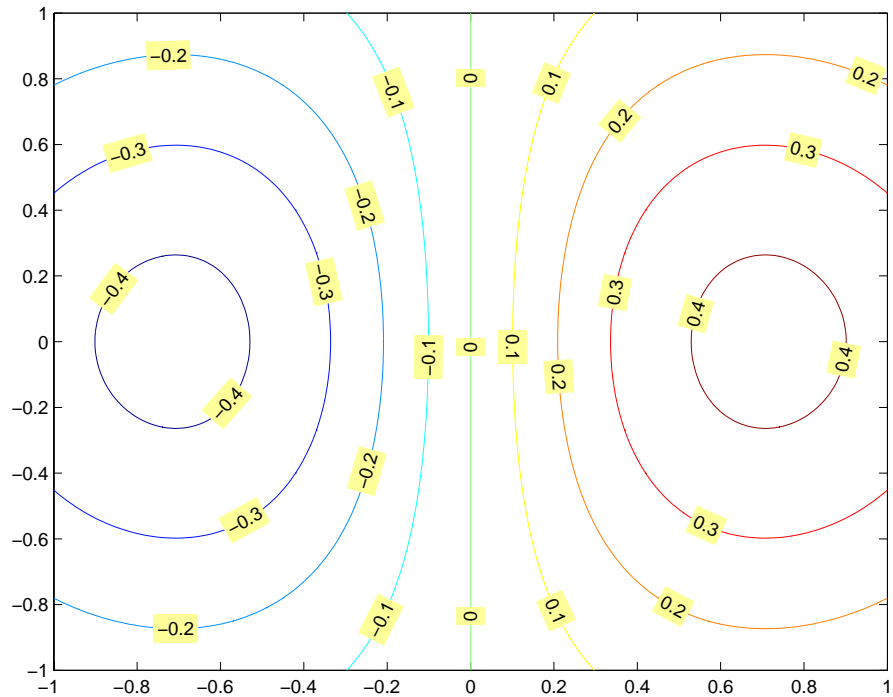

For additional features, see the following text properties:

- `BackgroundColor` — Color of the rectangle's interior (none by default)
- `EdgeColor` — Color of the rectangle's edge (none by default)
- `LineStyle` — Style of the rectangle's edge line (first set `EdgeColor`)
- `LineWidth` — Width of the rectangle's edge line (first set `EdgeColor`)
- `Margin` — Increase the size of the rectangle by adding a margin to the text extent.

Adding Arrows and Lines to Graphs

With plot editing mode enabled, you can add arrows and lines anywhere in a figure window.

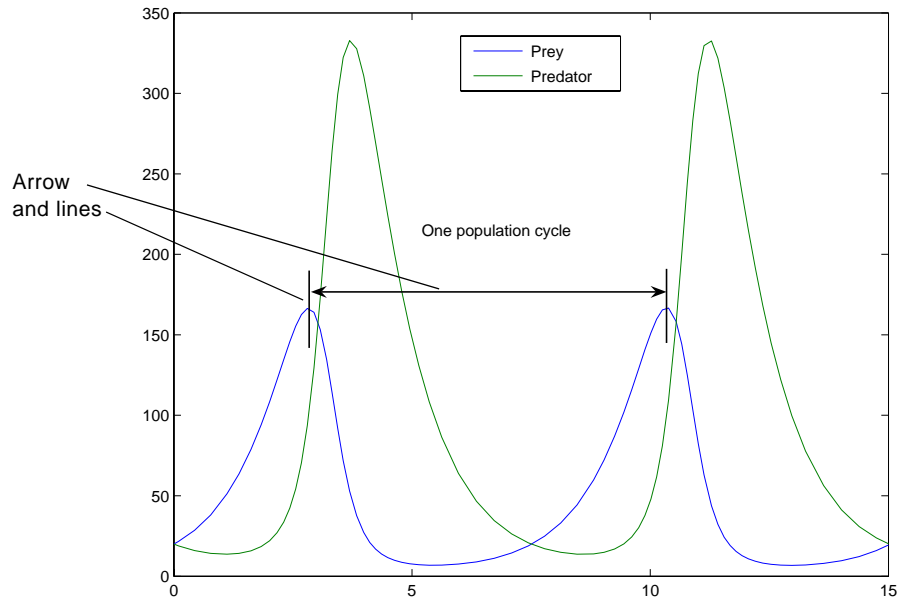

You can also use arrow characters (TeX characters) to create arrows using the text command. However, arrows created this way can only point to the left or right, horizontally. See “Calculating the Positions of Text Annotations” on page 3-36 for an example.

Creating Arrows and Lines in Plot Editing Mode

To add an arrow or line annotation to a graph,

- 1 Click the **Insert** menu and choose the **Arrow** or **Line** option, or click the Arrow or Line button in the Plot Edit toolbar.

MATLAB changes the cursor to a cross-hair.

- 2 Position the cursor in the figure where you want to start the line or arrow and press either mouse button. Hold the button down and move the mouse to define the length and direction of the line or arrow.
- 3 Release the mouse button.

Note After you add an arrow or line, plot edit mode is enabled in the figure, if it was not already enabled.

Editing Arrows and Line Annotations

You can edit the appearance of arrow and line annotations using the context menu.

With plot editing mode enabled, right-click on the arrow or line annotation to display its context menu.



For more options, select **Properties** to display the Property Editor.

Basic Plotting Commands

Basic Plotting Commands (p. 4-2)	Basic commands for creating line plots, specifying line styles, colors, and markers, and setting defaults
Line Plots of Matrix Data (p. 4-14)	Line plots of the rows or column of matrices
Plotting Imaginary and Complex Data (p. 4-16)	How the plot command handles complex data as a special case
Plotting with Two Y-Axes (p. 4-17)	Creating line plots that have left and right y -axes
Setting Axis Parameters (p. 4-20)	Specifying axis ticks location, tick labels, and axes aspect ratio
Figure Windows (p. 4-27)	Displaying multiple plots per figure, targeting a specific axes, figure color schemes

Basic Plotting Commands

MATLAB provides a variety of functions for displaying vector data as line plots, as well as functions for annotating and printing these graphs. The following table summarizes the functions that produce basic line plots. These functions differ in the way they scale the plot's axes. Each accepts input in the form of vectors or matrices and automatically scales the axes to accommodate the data.

Function	Description
plot	Graph 2-D data with linear scales for both axes
plot3	Graph 3-D data with linear scales for both axes
loglog	Graph with logarithmic scales for both axes
semilogx	Graph with a logarithmic scale for the x -axis and a linear scale for the y -axis
semilogy	Graph with a logarithmic scale for the y -axis and a linear scale for the x -axis
plotyy	Graph with y -tick labels on the left and right side

Plotting Steps

The process of constructing a basic graph to meet your presentation graphics requirements is outlined in the following table. The table shows seven typical steps and some example code for each.

If you are performing analysis only, you may want to view various graphs just to explore your data. In this case, steps 1 and 3 may be all you need. If you are creating presentation graphics, you may want to fine-tune your graph by

positioning it on the page, setting line styles and colors, adding annotations, and making other such improvements.

Step	Typical Code
1 Prepare your data	<pre>x = 0:0.2:12; y1 = bessell(1,x); y2 = bessell(2,x); y3 = bessell(3,x);</pre>
2 Select a window and position a plot region within the window	<pre>figure(1) subplot(2,2,1)</pre>
3 Call elementary plotting function	<pre>h = plot(x,y1,x,y2,x,y3);</pre>
4 Select line and marker characteristics	<pre>set(h,'LineWidth',2,{'LineStyle'},{'--';':';'-.'}) set(h,{'Color'},{'r';'g';'b'})</pre>
5 Set axis limits, tick marks, and grid lines	<pre>axis([0 12 -0.5 1]) grid on</pre>
6 Annotate the graph with axis labels, legend, and text	<pre>xlabel('Time') ylabel('Amplitude') legend(h,'First','Second','Third') title('Bessel Functions') [y,ix] = min(y1); text(x(ix),y,'First Min \rightarrow',... 'HorizontalAlignment','right')</pre>
7 Export graph	<pre>print -depsc -tiff -r200 myplot</pre>

Creating Line Plots

The `plot` function has different forms depending on the input arguments. For example, if `y` is a vector, `plot(y)` produces a linear graph of the elements of `y` versus the index of the elements of `y`. If you specify two vectors as arguments, `plot(x,y)` produces a graph of `y` versus `x`.

For example, the following statements create a vector of values in the range $[0, 2\pi]$ in increments of $\pi/100$ and then use this vector to evaluate the sine function

over that range. MATLAB plots the vector on the x -axis and the value of the sine function on the y -axis.

```
t = 0:pi/100:2*pi;  
y = sin(t);  
plot(t,y)  
grid on % Turn on grid lines for this plot
```

MATLAB automatically selects appropriate axis ranges and tick mark locations.

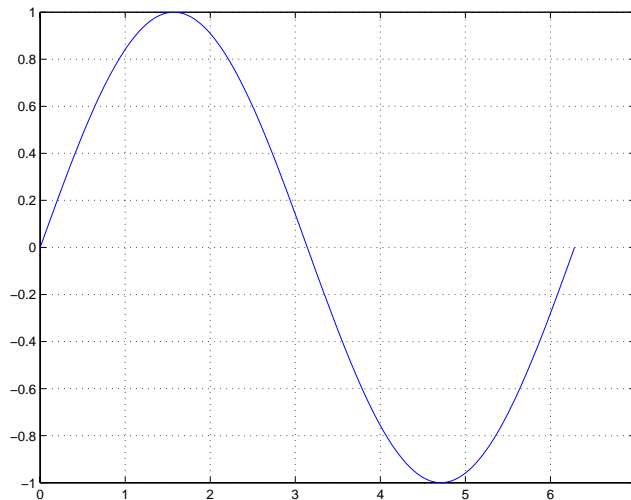

You can plot multiple graphs in one call to `plot` using x - y pairs. MATLAB automatically cycles through a predefined list of colors (determined by the `ColorOrder` property) to allow discrimination between sets of data. Plotting three curves as a function of t produces

```
y = sin(t);  
y2 = sin(t-0.25);  
y3 = sin(t-0.5);  
plot(t,y,t,y2,t,y3)
```

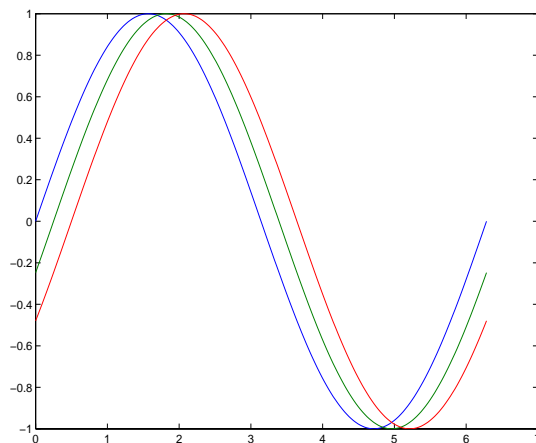

Specifying Line Style

You can assign different line styles to each data set by passing line style identifier strings to `plot`. For example,

```
t = 0:pi/100:2*pi;  
y = sin(t);  
y2 = sin(t-0.25);  
y3 = sin(t-0.5);  
plot(t,y,'-',t,y2,'--',t,y3,':')
```

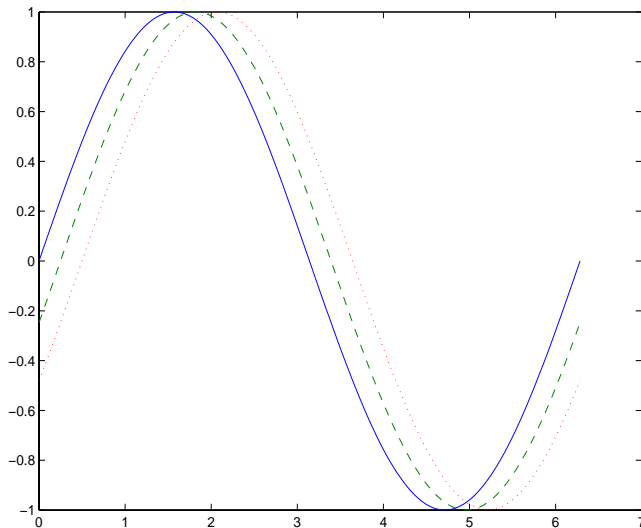

Colors, Line Styles, and Markers

The basic plotting functions accept character-string arguments that specify various line styles, marker symbols, and colors for each vector plotted. In the general form,

```
plot(x,y,'linestyle_marker_color')
```

`linestyle_marker_color` is a character string (delineated by single quotation marks) constructed from

- A line style (e.g., dashed, dotted, etc.)
- A marker type (e.g., x, *, o, etc.)
- A predefined color specifier (c, m, y, k, r, g, b, w)

For example,

```
plot(x,y,':squarey')
```

plots a yellow dotted line and places square markers at each data point. If you specify a marker type, but not a line style, MATLAB draws only the marker.

The specification can consist of one or none of each specifier in any order. For example, the string

```
'go- -'
```

defines a dashed line with circular markers, both colored green.

You can also specify the size of the marker and, for markers that are closed shapes, you can specify separately the colors of the edges and the face.

See the `LineStyleSpec` discussion for more information.

Specifying the Color and Size of Lines

You can control a number of line style characteristics by specifying values for line properties:

- `LineWidth` — Width of the line in units of points
- `MarkerEdgeColor` — Color of the marker or the edge color for filled markers (circle, square, diamond, pentagram, hexagram, and the four triangles)
- `MarkerFaceColor` — Color of the face of filled markers
- `MarkerSize` — Size of the marker in units of points

For example, these statements,

```
x = -pi:pi/10:pi;
y = tan(sin(x)) - sin(tan(x));
plot(x,y,'--rs','LineWidth',2,...
      'MarkerEdgeColor','k',...
      'MarkerFaceColor','g',...
      'MarkerSize',10)
```

produce a graph with

- A red dashed line with square markers
- A line width of two points
- The edge of the marker colored black
- The face of the marker colored green
- The size of the marker set to 10 points

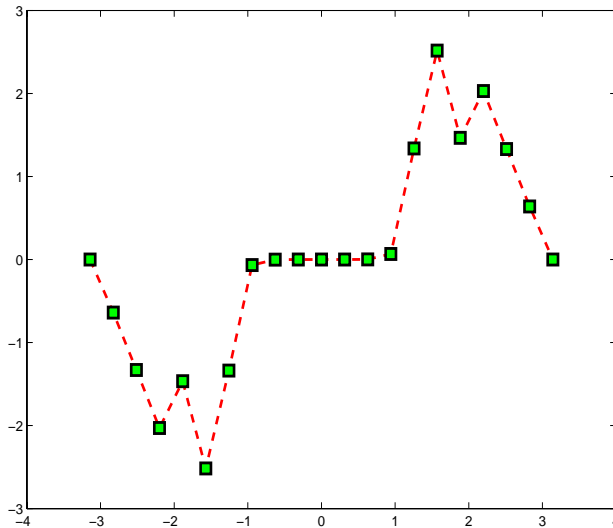

Adding Plots to an Existing Graph

You can add plots to an existing graph using the `hold` command. When you set `hold` to on, MATLAB does not remove the existing graph; it adds the new data to the current graph, rescaling if the new data falls outside the range of the previous axis limits.

For example, these statements first create a semilogarithmic plot, then add a linear plot.

```
semilogx(1:100, '+')
hold all % hold plot and cycle line colors
plot(1:3:300, 1:100, '--')
hold off
grid on % Turn on grid lines for this plot
```

While MATLAB resets the x -axis limits to accommodate the new data, it does not change the scaling from logarithmic to linear.

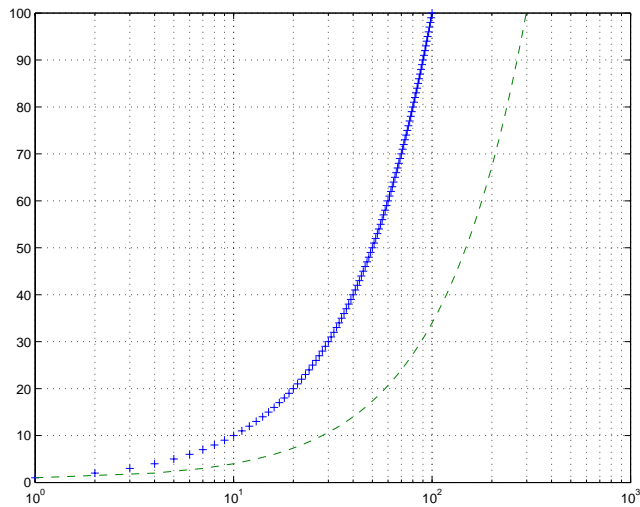

Plotting Only the Data Points

To plot a marker at each data point without connecting the markers with lines, use a specification that does not contain a line style. For example, given two vectors,

```
x = 0:pi/15:4*pi;  
y = exp(2*cos(x));
```

calling `plot` with only a color and marker specifier

```
plot(x,y, 'r+')
```

plots a red plus sign at each data point.

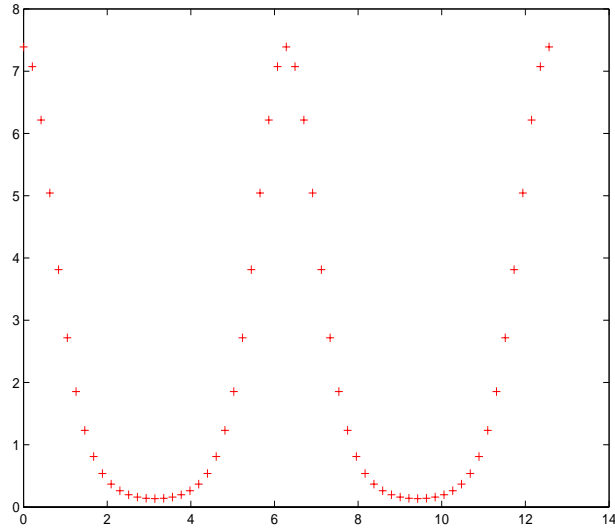

See `LineStyle` for a list of available line styles, markers, and colors.

Plotting Markers and Lines

To plot both markers and the lines that connect them, specify a line style and a marker type. For example, the following command plots the data as a red, solid line and then adds circular markers with black edges at each data point.

```
x = 0:pi/15:4*pi;  
y = exp(2*cos(x));  
plot(x,y, '-r',x,y, 'ok')
```

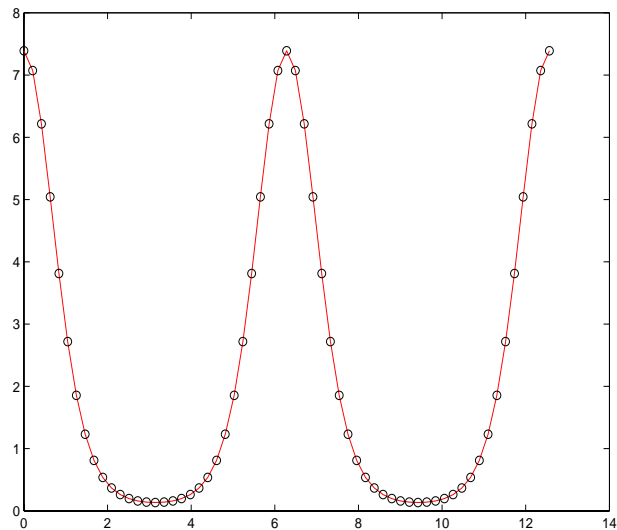

Line Styles for Black and White Output

Line styles and markers enable you to discriminate different plots on the same graph when color is not available. For example, the following statements create a graph using a solid ('-k') line with asterisk markers colored black and a dash-dot ('-.ok') line with circular markers colored black.

```
x = 0:pi/15:4*pi;  
y1 = exp(2*cos(x));  
y2 = exp(2*sin(x));  
plot(x,y1,'-k',x,y2,'-.ok')
```

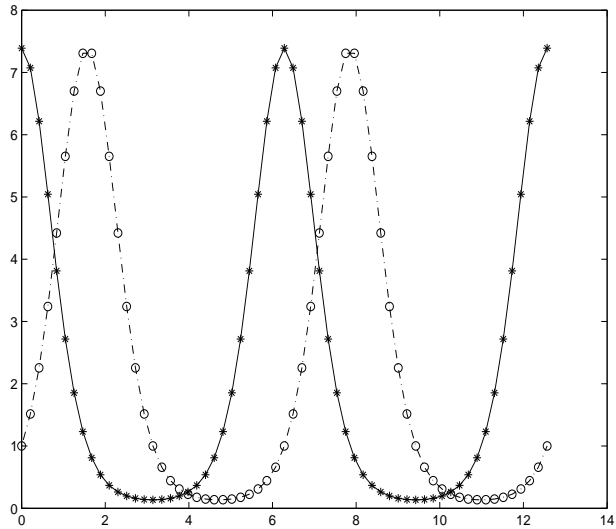

Setting Default Line Styles

You can configure MATLAB to use line styles instead of colors for multiline plots by setting a default value for the axes `LineStyleOrder` property. For example, the command

```
set(0,'DefaultAxesLineStyleOrder',{ '-o', ':s', '--+' })
```

defines three line styles and makes them the default for all plots.

To set the default line color to dark gray, use the statement

```
set(0,'DefaultAxesColorOrder',[0.4,0.4,0.4])
```

See `ColorSpec` for information on how to specify color as a three-element vector of RGB values.

Now the plot command uses the line styles and colors you have defined as defaults. For example, these statements create a multiline plot.

```
x = 0:pi/10:2*pi;  
y1 = sin(x);
```

```
y2 = sin(x-pi/2);  
y3 = sin(x-pi);  
plot(x,y1,x,y2,x,y3)
```

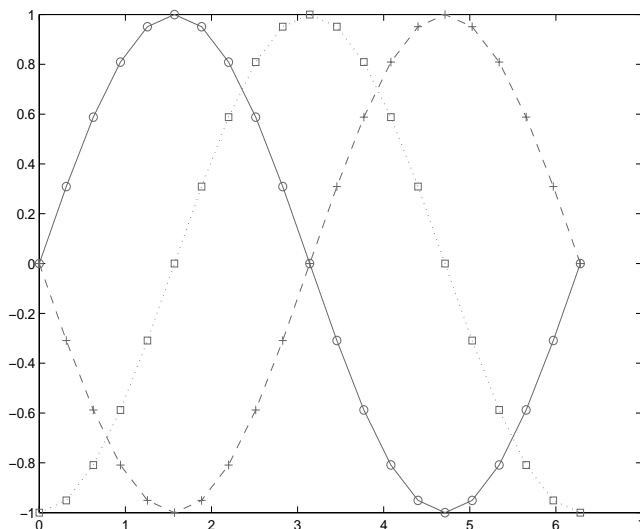

The default values persist until you quit MATLAB. To remove default values during your MATLAB session, use the reserved word `remove`.

```
set(0,'DefaultAxesLineStyleOrder','remove')  
set(0,'DefaultAxesColorOrder','remove')
```

See “Setting Default Property Values” on page 8-43 for more information.

Line Plots of Matrix Data

When you call the `plot` function with a single matrix argument

```
plot(Y)
```

MATLAB draws one line for each column of the matrix. The x -axis is labeled with the row index vector $1:m$, where m is the number of rows in Y . For example,

```
Z = peaks;
```

returns a 49-by-49 matrix obtained by evaluating a function of two variables. Plotting this matrix

```
plot(Z)
```

produces a graph with 49 lines.

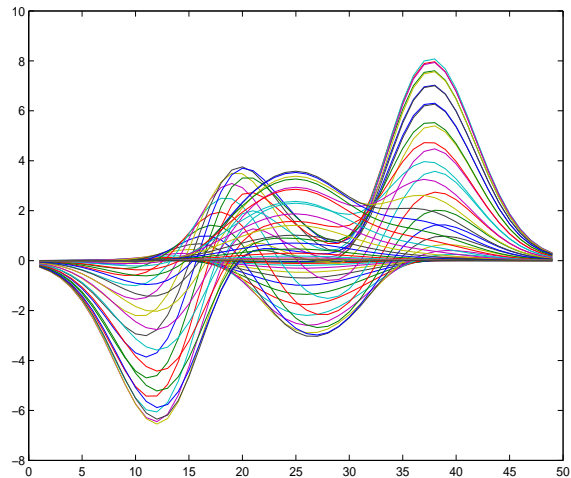

In general, if `plot` is used with two arguments and if either X or Y has more than one row or column, then

- If Y is a matrix, and x is a vector, `plot(x, Y)` successively plots the rows or columns of Y versus vector x , using different colors or line types for each. The

row or column orientation varies depending on whether the number of elements in x matches the number of rows in Y or the number of columns. If Y is square, its columns are used.

- If X is a matrix and y is a vector, `plot(X,y)` plots each row or column of X versus vector y . For example, plotting the peaks matrix versus the vector `1:length(peaks)` rotates the previous plot.

```
y = 1:length(peaks);
plot(peaks,y)
```

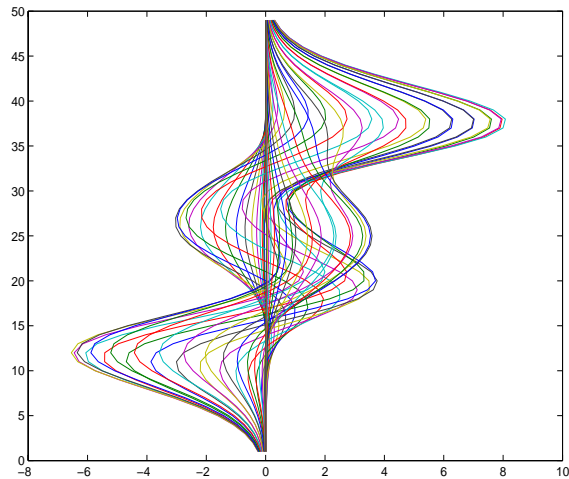

- If X and Y are both matrices of the same size, `plot(X,Y)` plots the columns of X versus the columns of Y .

You can also use the `plot` function with multiple pairs of matrix arguments.

```
plot(X1,Y1,X2,Y2,...)
```

This statement graphs each X - Y pair, generating multiple lines. The different pairs can be of different dimensions.

Plotting Imaginary and Complex Data

When the arguments to `plot` are complex (i.e., the imaginary part is nonzero), MATLAB ignores the imaginary part *except* when `plot` is given a single complex data argument. For this special case, the command is a shortcut for a plot of the real part versus the imaginary part. Therefore,

```
plot(Z)
```

where `Z` is a complex vector or matrix, is equivalent to

```
plot(real(Z), imag(Z))
```

For example, this statement plots the distribution of the eigenvalues of a random matrix using circular markers to indicate the data points.

```
plot(eig(randn(20,20)), 'o', 'MarkerSize', 6)
```

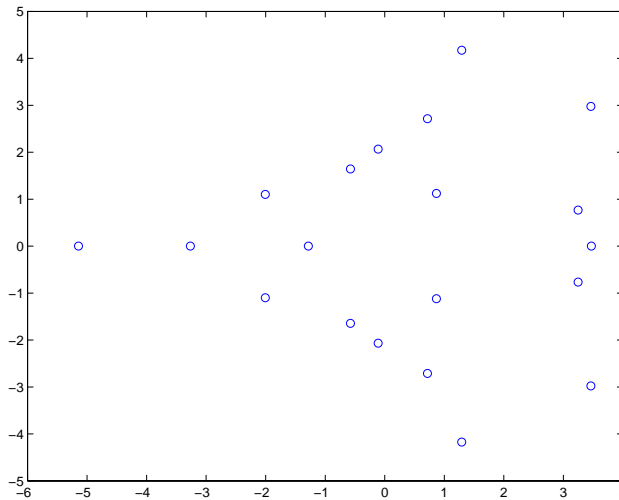

To plot more than one complex matrix, there is no shortcut; the real and imaginary parts must be taken explicitly.

Plotting with Two Y-Axes

The `plotyy` command enables you to create plots of two data sets and use both left and right side y -axes. You can also apply different plotting functions to each data set. For example, you can combine a line plot with a stem plot of the same data.

```
t = 0:pi/20:2*pi;
y = exp(sin(t));
plotyy(t,y,t,y,'plot','stem')
```

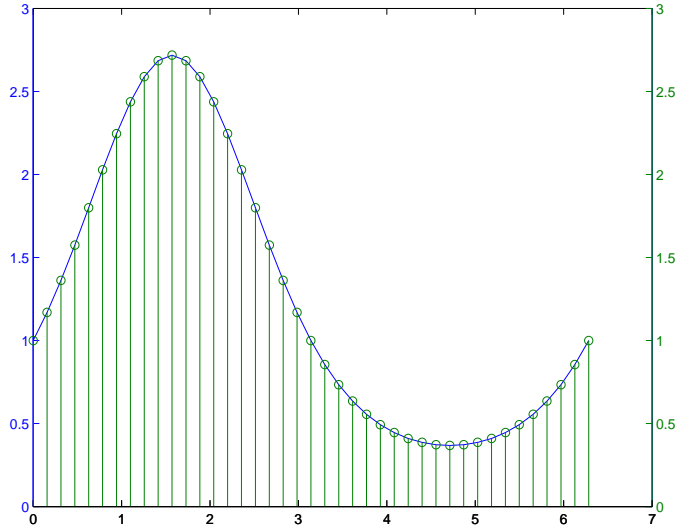

Combining Linear and Logarithmic Axes

You can use `plotyy` to apply linear and logarithmic scaling to compare two data sets having different ranges of values.

```
t = 0:900; A = 1000; a = 0.005; b = 0.005;
z1 = A*exp(-a*t);
z2 = sin(b*t);
[haxes,hline1,hline2] = plotyy(t,z1,t,z2,'semilogy','plot');
```

This example saves the handles of the lines and axes created to adjust and label the graph. First, label the axes whose y value ranges from 10 to 1000. This is the first handle in `haxes` because it was specified first in the call to `plotyy`. Use the `axes` command to make `haxes(1)` the current axes, which is then the target for the `ylabel` command.

```
axes(haxes(1))  
ylabel('Semilog Plot')
```

Now make the second axes current and call `ylabel` again.

```
axes(haxes(2))  
ylabel('Linear Plot')
```

You can modify the characteristics of the plotted lines in a similar way. For example, to change the line style of the second line plotted to a dashed line, use the statement

```
set(hline2, 'LineStyle', '--')
```

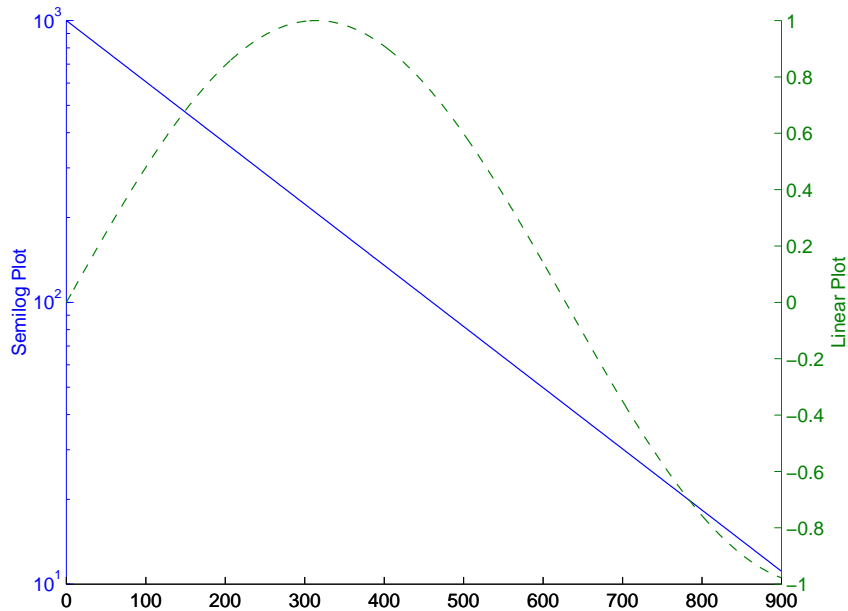

See “Using Multiple X- and Y-Axes” on page 10-22 for an example that employs double x - and y -axes.

See `LineStyle` for additional line properties.

Setting Axis Parameters

When you create a graph, MATLAB automatically selects the axis limits and tick-mark spacing based on the data plotted. However, you can also specify your own values for axis limits and tick marks with the following commands:

- `axis` — Sets values that affect the current axes object (the most recently created or the last clicked on).
- `axes` — (Not `axis`) creates a new axes object with the specified characteristics.
- `get` and `set` — Enable you to query and set a wide variety of properties of existing axes.
- `gca` — Returns the handle (identifier) of the current axes. If there are multiple axes in the figure window, the current axes is the last graph created or the last graph you clicked on with the mouse. The following two sections provide more information and examples:

“Axis Limits and Ticks” on page 4-20

“Example — Specifying Ticks and Tick Labels” on page 4-23

Related Information

See *Defining the View* for more extensive information on manipulating 3-D views.

Axis Limits and Ticks

MATLAB selects axis limits based on the range of the plotted data. You can specify the limits manually using the `axis` command. Call `axis` with the new limits defined as a four-element vector.

```
axis([xmin,xmax,ymin,ymax])
```

Note that the minimum values must be less than the maximum values.

Semiautomatic Limits

If you want MATLAB to autoscale only one of a min/max set of axis limits, but you want to specify the other, use the MATLAB variable `Inf` or `-Inf` for the autoscaled limit. For example, this graph uses default scaling.

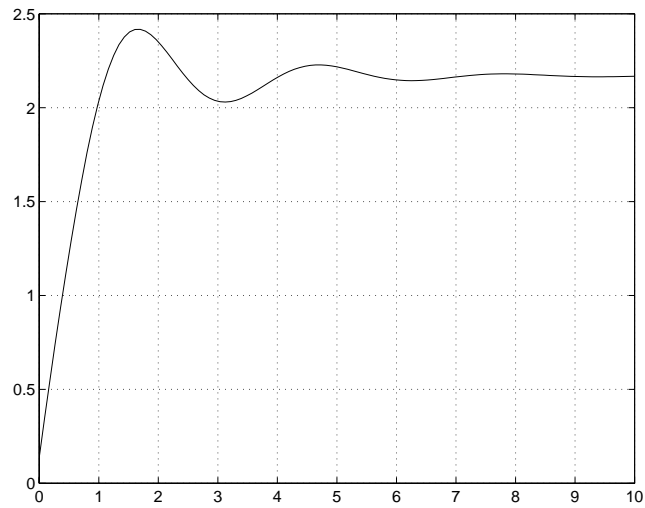

Compare the default limits to the following graph, which sets the maximum limit of the x -axis, but autoscales the minimum limit.

```
axis([-Inf 5 2 2.5])
```

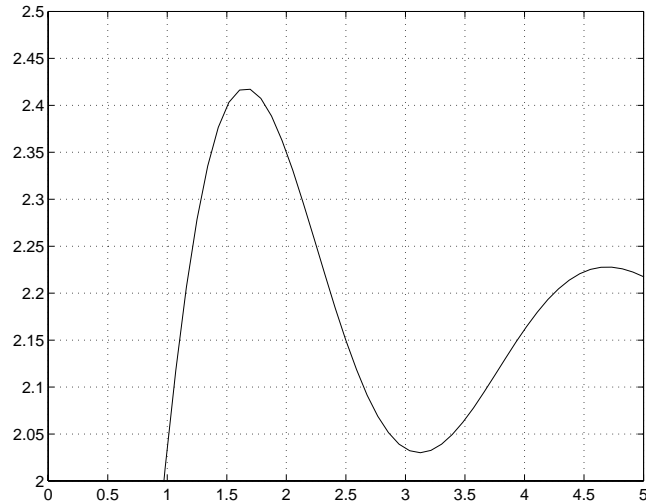

Axis Tick Marks

MATLAB selects the tick-mark locations based on the range of data so as to produce equally spaced ticks (for linear graphs). You can specify different tick marks by setting the axes `XTick` and `YTick` properties. Define tick marks as a vector of increasing values. The values do not need to be equally spaced.

For example, setting the y-axis tick marks for the graph from the preceding example,

```
set(gca, 'ytick', [2 2.1 2.2 2.3 2.4 2.5])
```

produces a graph with only the specified ticks on the y-axis.

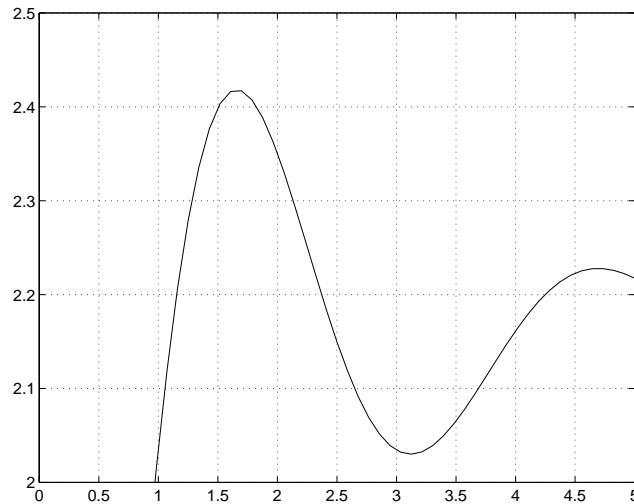

Note that if you specify tick-mark values that are outside the axis limits, MATLAB does not display them (that is, specifying tick marks cannot cause axis limits to change).

Example – Specifying Ticks and Tick Labels

You can adjust the axis tick-mark locations and the labels appearing at each tick mark. For example, this plot of the sine function relabels the x -axis with more meaningful values.

```
x = -pi:.1:pi;
y = sin(x);
plot(x,y)
set(gca,'XTick',-pi:pi/2:pi)
set(gca,'XTickLabel',{'-pi','-pi/2','0','pi/2','pi'})
```

These commands (`xlabel`, `ylabel`, `title`, `text`) add axis labels and draw an arrow that points to the location on the graph where $y = \sin(-\pi/4)$.

```
xlabel('-\pi \leq \Theta \leq \pi')
ylabel('sin(\Theta)')
title('Plot of sin(\Theta)')
```

```
text(-pi/4,sin(-pi/4),'\leftarrow sin(-\pi\div4)',...  
     'HorizontalAlignment','left')
```

Setting Line Properties on an Existing Plot

Change the line color to purple by first finding the handle of the line object created by `plot` and then setting its `Color` property. Use `findobj` and the fact that MATLAB creates a blue line (RGB value `[0 0 1]`) by default. In the same statement, set the `LineWidth` property to 2 points.

```
set(findobj(gca,'Type','line','Color',[0 0 1]),...  
    'Color',[0.5,0,0.5],'LineWidth',2)
```

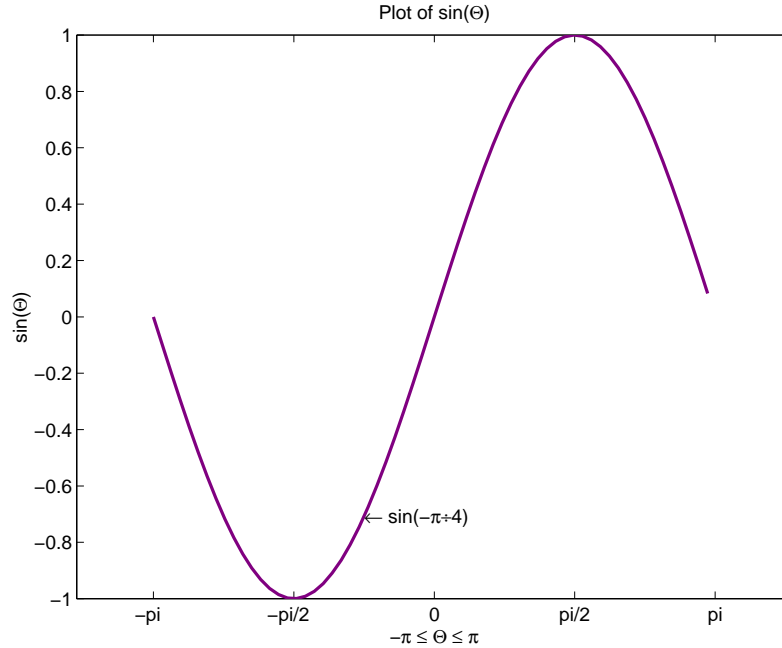

The Greek symbols are created using TeX character sequences.

Setting Aspect Ratio

By default, MATLAB displays graphs in a rectangular axes that has the same aspect ratio as the figure window. This makes optimum use of space available

for plotting. MATLAB provides control over the aspect ratio with the `axis` command.

For example,

```
t = 0:pi/20:2*pi;  
plot(sin(t),2*cos(t))  
grid on
```

produces a graph with the default aspect ratio. The command

```
axis square
```

makes the x - and y -axes equal in length.

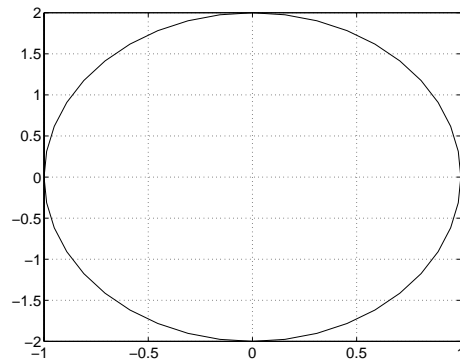

axis normal

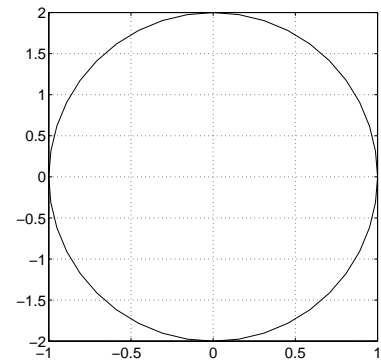

axis square

The square axes has one data unit in x to equal two data units in y . If you want the x - and y -data units to be equal, use the command

```
axis equal
```

This produces an axes that is rectangular in shape, but has equal scaling along each axis.

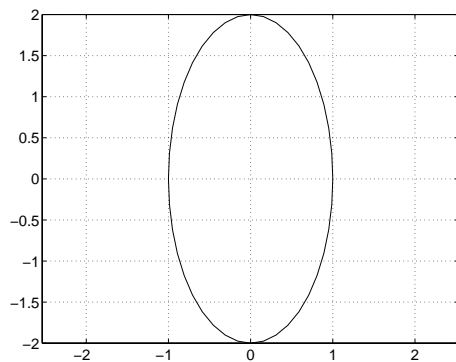

axis equal

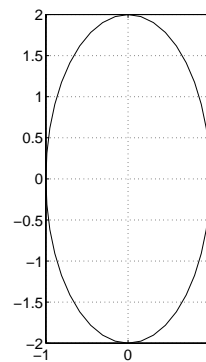

axis equal tight

If you want the axes shape to conform to the plotted data, use the `tight` option in conjunction with `equal`.

```
axis equal tight
```

Figure Windows

MATLAB directs graphics output to a window that is separate from the Command Window. In MATLAB this window is referred to as a *figure*. The characteristics of this window are controlled by your computer's windowing system and MATLAB figure properties (see a description of each property). See "Figure Properties" on page 9-1 for some examples illustrating how to use figure properties.

Graphics functions automatically create new figure windows if none currently exist. If a figure already exists, MATLAB uses that window. If multiple figures exist, one is designated as the *current figure* and is used by MATLAB (this is generally the last figure used or the last figure you clicked the mouse in).

The `figure` function creates figure windows. For example,

```
figure
```

creates a new window and makes it the current figure. You can make an existing figure current by clicking it with the mouse or by passing its handle (the number indicated in the window title bar), as an argument to `figure`.

```
figure(h)
```

Displaying Multiple Plots per Figure

You can display multiple plots in the same figure window and print them on the same piece of paper with the `subplot` function.

`subplot(m,n,i)` breaks the figure window into an m -by- n matrix of small subplots and selects the i th subplot for the current plot. The plots are numbered along the top row of the figure window, then the second row, and so forth.

For example, the following statements plot data in four different subregions of the figure window.

```
t = 0:pi/20:2*pi;
[x,y] = meshgrid(t);

subplot(2,2,1)
plot(sin(t),cos(t))
axis equal
```

```
subplot(2,2,2)
z = sin(x)+cos(y);
plot(t,z)
axis([0 2*pi -2 2])

subplot(2,2,3)
z = sin(x).*cos(y);
plot(t,z)
axis([0 2*pi -1 1])

subplot(2,2,4)
z = (sin(x).^2)-(cos(y).^2);
plot(t,z)
axis([0 2*pi -1 1])
```

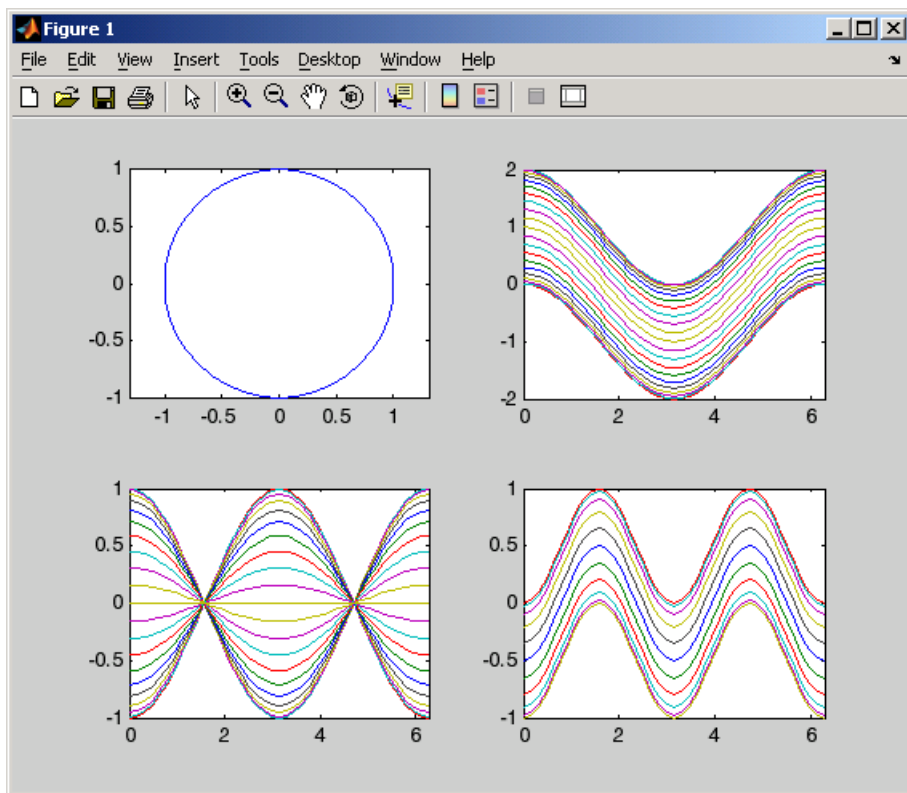

Each subregion contains its own axes with characteristics you can control independently of the other subregions. This example uses the `axis` command to set limits and change the shape of the subplots.

See the `axes`, `axis`, and `subplot` functions for more information.

Specifying the Target Axes

The current axes is the last one defined by `subplot`. If you want to access a previously defined subplot, for example to add a title, you must first make that axes current.

You can make an axes current in three ways:

- Click on the subplot with the mouse.
- Call `subplot` the `m`, `n`, `i` specifiers.
- Call `subplot` with the handle (identifier) of the axes.

For example,

```
subplot(2,2,2)
title('Top Right Plot')
```

adds a title to the plot in the upper right side of the figure.

You can obtain the handles of all the subplot axes with the statement

```
h = get(gcf, 'Children');
```

MATLAB returns the handles of all the axes, with the most recently created one first. That is, `h(1)` is subplot 224, `h(2)` is subplot 223, `h(3)` is subplot 222, and `h(4)` is subplot 221. For example, to replace subplot 222 with a new plot, first make it the current axes with

```
subplot(h(3))
```

Default Color Scheme

The default figure color scheme produces good contrast and visibility for the various graphics functions. This scheme defines colors for the window background, the axis background, the axis lines and labels, the colors of the lines used for plotting and surface edges, and other properties that affect appearance.

The `colordef` function enables you to select from predefined color schemes and to modify colors individually. `colordef` predefines three color schemes:

- `colordef white` — Sets the axis background color to white, the window background color to gray, the colormap to `jet`, surface edge colors to black, and defines appropriate values for the plotting color order and other properties.
- `colordef black` — Sets the axis background color to black, the window background color to dark gray, the colormap to `jet`, surface edge colors to black, and defines appropriate values for the plotting color order and other properties.
- `colordef none` — Set the colors to match that of MATLAB 4. This is basically a black background with white axis lines and no grid. MATLAB programs that are based on the MATLAB 4 color scheme may need to call `colordef` with the `none` option to produce the expected results.

You can examine the `colordef.m` M-file to determine what properties it sets (enter `type colordef` at the MATLAB prompt).

Creating Specialized Plots

Bar and Area Graphs (p. 5-2)	View results over time, comparing results, and displaying individual contribution to a total amount
Pie Charts (p. 5-14)	Individual contribution to a total amount
Histograms (p. 5-17)	Distribution of data values
Discrete Data Graphs (p. 5-22)	Stem and staircase plots of discrete data
Direction and Velocity Vector Graphs (p. 5-31)	Compass, feather, and quiver plots show direction and magnitude.
Contour Plots (p. 5-37)	Indicate locations of equal data values.
Interactive Plotting (p. 5-48)	User-selectable data point (using mouse) for plotting
Animation (p. 5-50)	Show an additional data dimension by sequencing plots.

Bar and Area Graphs

Bar and area graphs display vector or matrix data. These types of graphs are useful for viewing results over a period of time, comparing results from different data sets, and showing how individual elements contribute to an aggregate amount. Bar graphs are suitable for displaying discrete data, whereas area graphs are more suitable for displaying continuous data.

Function	Description
bar	Displays columns of m -by- n matrix as m groups of n vertical bars
barh	Displays columns of m -by- n matrix as m groups of n horizontal bars
bar3	Displays columns of m -by- n matrix as m groups of n vertical 3-D bars
bar3h	Displays columns of m -by- n matrix as m groups of n horizontal 3-D bars
area	Displays vector data as stacked area plots

Types of Bar Graphs

MATLAB has four specialized functions that display bar graphs. These functions display 2- and 3-D bar graphs, and vertical and horizontal bar graphs.

	Two-Dimensional	Three-Dimensional
Vertical	bar	bar3
Horizontal	barh	bar3h

Grouped Bar Graph

By default, a bar graph represents each element in a matrix as one bar. Bars in a 2-D bar graph, created by the bar function, are distributed along the x -axis with each element in a column drawn at a different location. All elements in a row are clustered around the same location on the x -axis.

For example, define Y as a simple matrix and issue the `bar` statement in its simplest form.

```
Y = [5 2 1
      8 7 3
      9 8 6
      5 5 5
      4 3 2];
```

```
bar(Y)
```

The bars are clustered together by rows and evenly distributed along the x -axis.

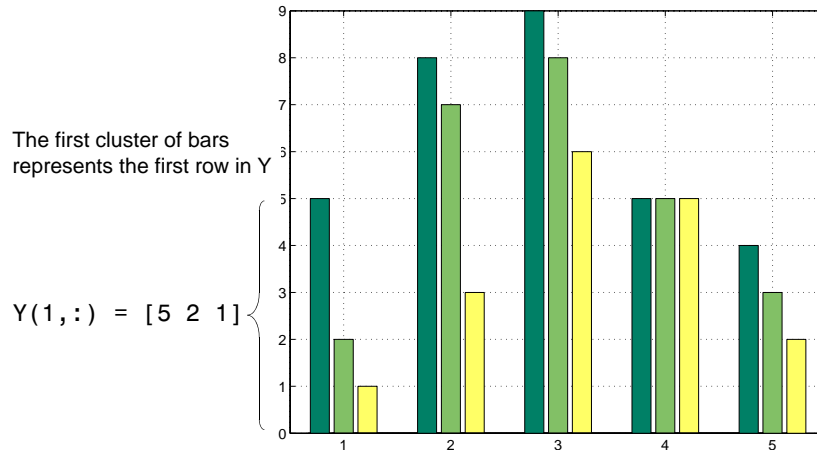

Detached 3-D Bars

The `bar3` function, in its simplest form, draws each element as a separate 3-D block, with the elements of each column distributed along the y -axis. Bars that represent elements in the first column of the matrix are centered at 1 along the x -axis. Bars that represent elements in the last column of the matrix are centered at `size(Y,2)` along the x -axis. For example,

```
bar3(Y)
```

displays five groups of three bars along the y -axis. Notice that larger bars obscure $Y(1,2)$ and $Y(1,3)$.

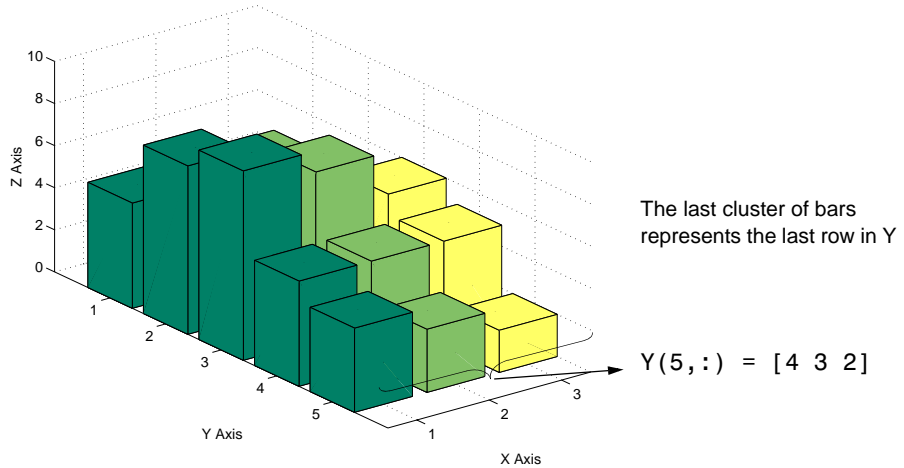

By default, `bar3` draws detached bars. The statement `bar3(Y, 'detach')` has the same effect.

Labeling the Graph. To add axes labels and x tick marks to this bar graph, use the statements

```
xlabel('X Axis')
ylabel('Y Axis')
zlabel('Z Axis')
set(gca, 'XTick', [1 2 3])
```

Grouped 3-D Bars

Cluster the bars from each row beside each other by specifying the argument 'group'. For example,

```
bar3(Y, 'group')
```

groups the bars according to row and distributes the clusters evenly along the y -axis.

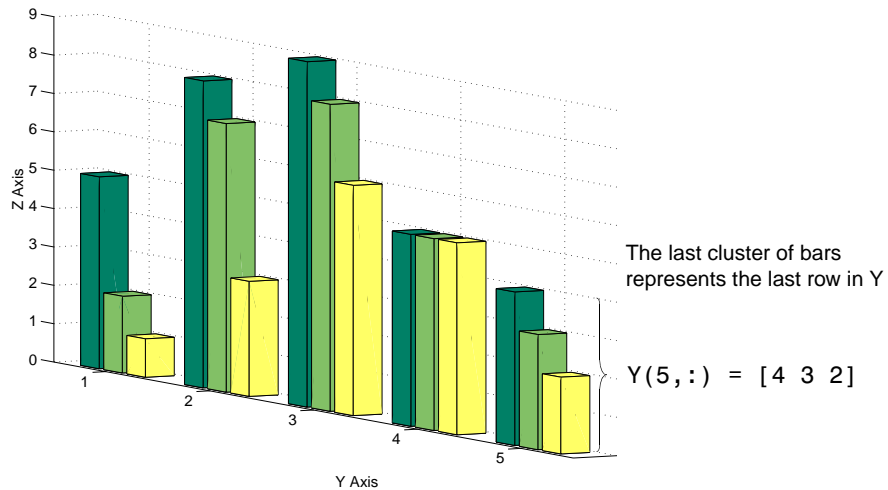

Stacked Bar Graphs to Show Contributing Amounts

Bar graphs can show how elements in the same row of a matrix contribute to the sum of all elements in the row. These types of bar graphs are referred to as stacked bar graphs.

Stacked bar graphs display one bar per row of a matrix. The bars are divided into n segments, where n is the number of columns in the matrix. For vertical bar graphs, the height of each bar equals the sum of the elements in the row. Each segment is equal to the value of its respective element.

Redefining Y

```
Y = [5 1 2
     8 3 7
     9 6 8
     5 5 5
     4 2 3];
```

Create stacked bar graphs using the optional 'stack' argument. For example,

```
bar(Y,'stack')
grid on
set(gca,'Layer','top') % display gridlines on top of graph
```

creates a 2-D stacked bar graph, where all elements in a row correspond to the same x location.

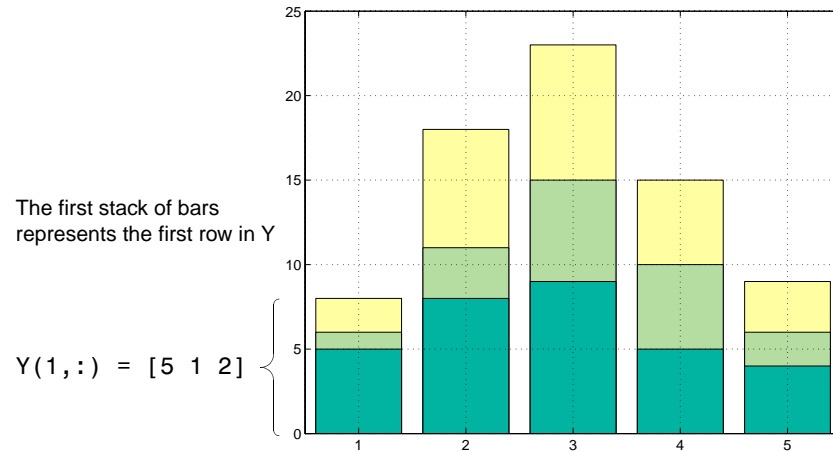

Horizontal Bar Graphs

For horizontal bar graphs, the length of each bar equals the sum of the elements in the row. The length of each segment is equal to the value of its respective element.

```
barh(Y, 'stack')  
grid on  
set(gca, 'Layer', 'top') % Display gridlines on top of graph
```

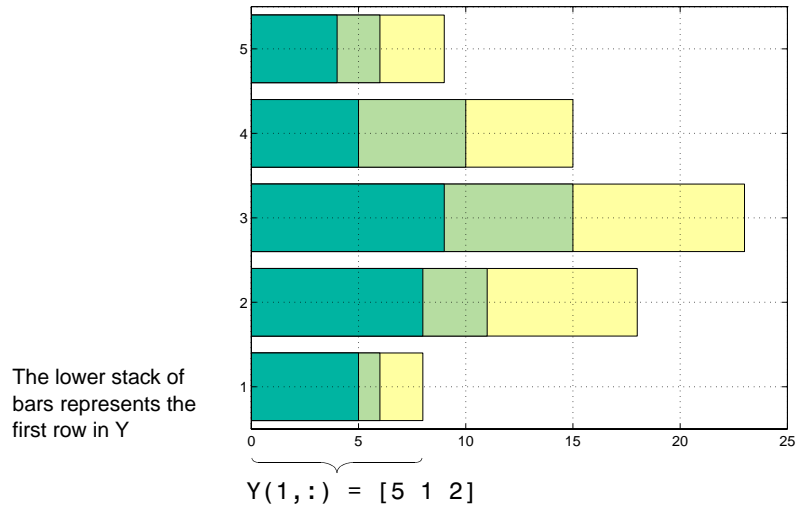

Specifying X-Axis Data

Bar graphs automatically generate x -axis values and label the x -axis tick lines. You can specify a vector of x values (or y values in the case of horizontal bar graphs) to label the axes.

For example, given temperature data,

```
temp = [29 23 27 25 20 23 23 27];
```

obtained from samples taken every five days during a thirty-five day period,

```
days = 0:5:35;
```

you can display a bar graph showing temperature measured along the y -axis and days along the x -axis using

```
bar(days,temp)
```

These statements add labels to the x - and y -axis.

```
xlabel('Day')
ylabel('Temperature (^{o}C)')
```

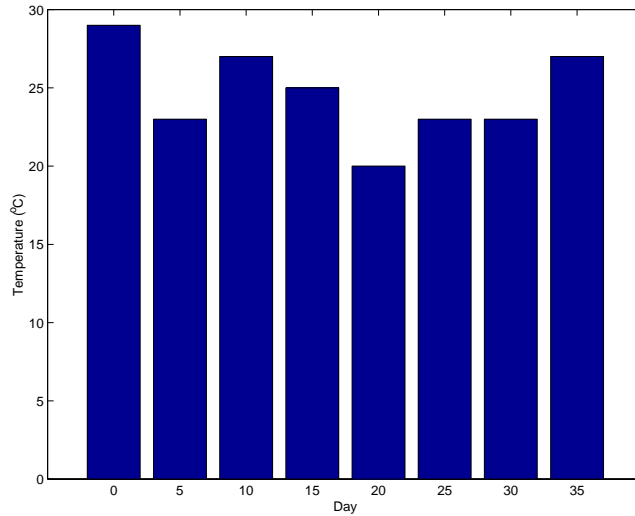

Setting Y-Axis Limits

By default, the y -axis range is from 0 to 30. To focus on the temperature range from 15 to 30, change the y -axis limits.

```
set(gca, 'YLim', [15 30], 'Layer', 'top')
```

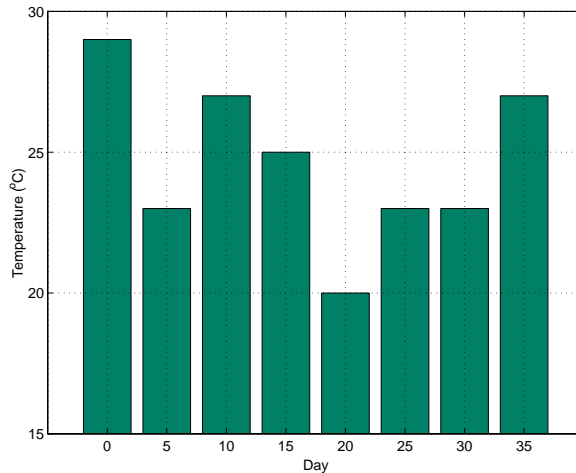
Overlaying Plots on Bar Graphs

You can overlay data on a bar graph by creating another axes in the same position. This enables you to have an independent y -axis for the overlaid dataset (in contrast to the `hold on` statement, which uses the same axes).

For example, consider a bioremediation experiment that breaks down hazardous waste components into nontoxic materials. The trichloroethylene (TCE) concentration and temperature data from this experiment are

```
TCE = [515 420 370 250 135 120 60 20];  
temp = [29 23 27 25 20 23 23 27];
```

This data was obtained from samples taken every five days during a thirty-five day period.

```
days = 0:5:35;
```

Display a bar graph and label the x - and y -axis using the statements

```
bar(days,temp)  
xlabel('Day')  
ylabel('Temperature (^{o}C)')
```

Overlaying a Line Plot on the Bar Graph

To overlay the concentration data on the bar graph, position a second axes at the same location as the first axes, but first save the handle of the first axes.

```
h1 = gca;
```

Create the second axes at the same location before plotting the second dataset.

```
h2 = axes('Position',get(h1,'Position'));
plot(days,TCE,'LineWidth',3)
```

To ensure that the second axes does not interfere with the first, locate the y-axis on the right side of the axes, make the background transparent, and set the second axes' x-tick marks to the empty matrix.

```
set(h2,'YAxisLocation','right','Color','none','XTickLabel',[])
```

Align the x-axis of both axes and display the grid lines on top of the bars.

```
set(h2,'XLim',get(h1,'XLim'),'Layer','top')
```

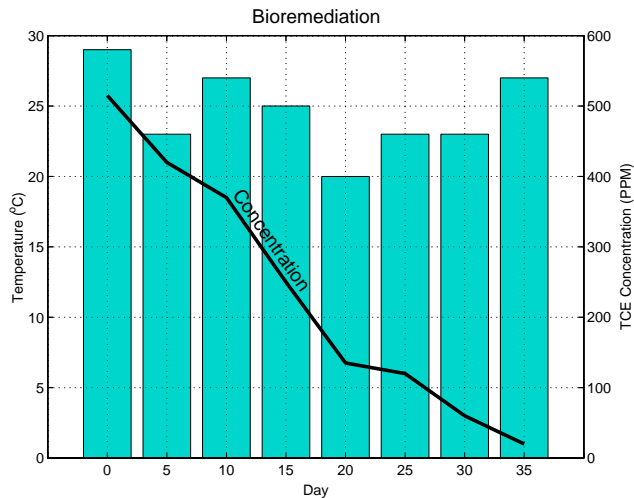

Annotating the Graph. These statements annotate the graph.

```
text(11,380,'Concentration','Rotation',-55,'FontSize',16)
ylabel('TCE Concentration (PPM)')
```

```
title('Bioremediation','FontSize',16)
```

To print the graph, set the current figure's `PaperPositionMode` to `auto`, which ensures the printed output matches the display.

```
set(gcf,'PaperPositionMode','auto')
```

Area Graphs

The `area` function displays curves generated from a vector or from separate columns in a matrix. `area` plots the values in each column of a matrix as a separate curve and fills the area between the curve and the x -axis.

Area Graphs Showing Contributing Amounts

Area graphs are useful for showing how elements in a vector or matrix contribute to the sum of all elements at a particular x location. By default, `area` accumulates all values from each row in a matrix and creates a curve from those values.

Using this matrix,

```
Y = [5 1 2  
     8 3 7  
     9 6 8  
     5 5 5  
     4 2 3];
```

the statement

```
area(Y)
```

displays a graph containing three area graphs, one per column.

The height of the area graph is the sum of the elements in each row. Each successive curve uses the preceding curve as its base.

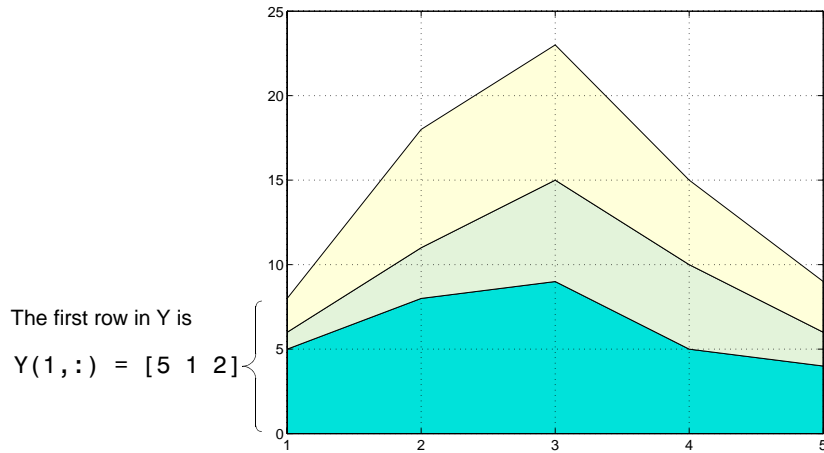

Displaying the Grid on Top. To display the grid lines in the foreground of the area graph and display only five grid lines along the x -axis, use the statements

```
set(gca, 'Layer', 'top')
set(gca, 'XTick', 1:5)
```

Comparing Data Sets with Area Graphs

Area graphs are useful for comparing different datasets. For example, given a vector containing sales figures,

```
sales = [51.6 82.4 90.8 59.1 47.0];
```

for the five-year period

```
x = 90:94;
```

and a vector containing profits figures for the same five-year period,

```
profits = [19.3 34.2 61.4 50.5 29.4];
```

display both as two separate area graphs within the same axes. Set the color of the area interior (`FaceColor`), its edges (`EdgeColor`), and the width of the edge lines (`LineWidth`). See `patch` for a complete list of properties.

```
area(x,sales,'FaceColor',[.5 .9 .6],...
```

```

        'EdgeColor','b',...
        'LineWidth',2)
hold on
area(x,profits,'FaceColor',[.9 .85 .7],...
     'EdgeColor','y',...
     'LineWidth',2)
hold off

```

To annotate the graph, use the statements

```

set(gca,'XTick',[90:94])
set(gca,'Layer','top')
gtext('\leftarrow Sales')
gtext('Profits')
gtext('Expenses')
xlabel('Years','FontSize',14)
ylabel('Expenses + Profits = Sales in 1,000's','FontSize',14)

```

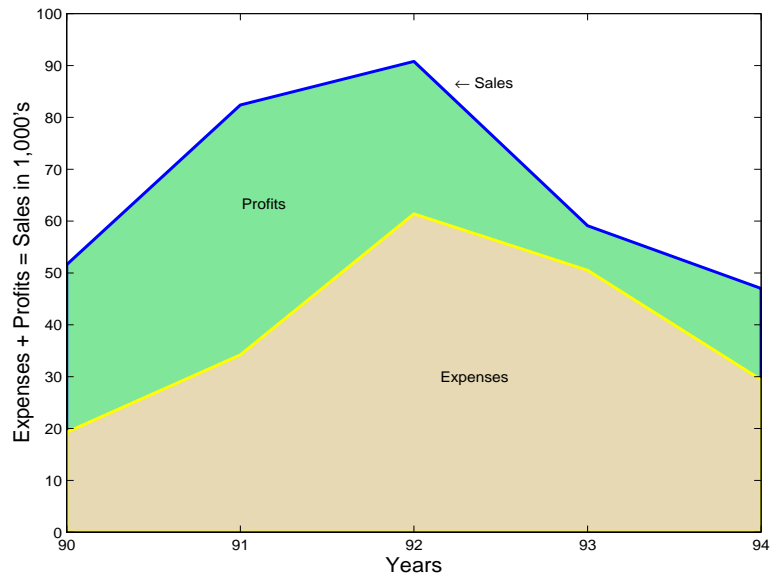

Pie Charts

Pie charts display the percentage that each element in a vector or matrix contributes to the sum of all elements. `pie` and `pie3` create 2-D and 3-D pie charts.

Example — Pie Chart

Here is an example using the `pie` function to visualize the contribution that three products make to total sales. Given a matrix `X` where each column of `X` contains yearly sales figures for a specific product over a five-year period,

```
X = [19.3 22.1 51.6;  
     34.2 70.3 82.4;  
     61.4 82.9 90.8;  
     50.5 54.9 59.1;  
     29.4 36.3 47.0];
```

sum each row in `X` to calculate total sales for each product over the five-year period.

```
x = sum(X);
```

You can offset the slice of the pie that makes the greatest contribution using the `explode` input argument. This argument is a vector of zero and nonzero values. Nonzero values offset the respective slice from the chart.

First, create a vector containing zeros.

```
explode = zeros(size(x));
```

Then find the slice that contributes the most and set the corresponding `explode` element to 1.

```
[c,offset] = max(x);  
explode(offset) = 1;
```

The `explode` vector contains the elements `[0 0 1]`. To create the exploded pie chart, use the statement

```
h = pie(x,explode); colormap summer
```

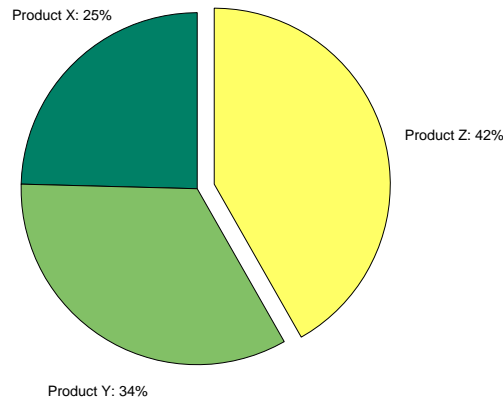

Labeling the Graph

The pie chart's labels are text graphics objects. To modify the text strings and their positions, first get the objects' strings and extents. Braces around a property name ensure that get outputs a cell array, which is important when working with multiple objects.

```
textObjs = findobj(h,'Type','text');
oldStr = get(textObjs,{'String'});
val = get(textObjs,{'Extent'});
oldExt = cat(1,val{:});
```

Create the new strings, then set the text objects' String properties to the new strings.

```
Names = {'Product X: ','Product Y: ','Product Z: '};
newStr = strcat(Names,oldStr);
set(textObjs,{'String'},newStr)
```

Find the difference between the widths of the new and old text strings and change the values of the Position properties.

```
val1 = get(textObjs, {'Extent'});
newExt = cat(1, val1{:});
offset = sign(oldExt(:,1)).*(newExt(:,3) - oldExt(:,3))/2;
```

```
pos = get(textObjs, {'Position'});  
textPos = cat(1, pos{:});  
textPos(:,1) = textPos(:,1)+offset;  
set(textObjs,{'Position'},num2cell(textPos,[3,2]))
```

Removing a Piece from a Pie Chart

When the sum of the elements in the first input argument is equal to or greater than 1, `pie` and `pie3` normalize the values. So, given a vector of elements x , each slice has an area of $x_i / \text{sum}(x_i)$, where x_i is an element of x . The normalized value specifies the fractional part of each pie slice.

When the sum of the elements in the first input argument is less than 1, `pie` and `pie3` do not normalize the elements of vector x . They draw a partial pie. For example,

```
x = [.19 .22 .41];  
pie(x)
```

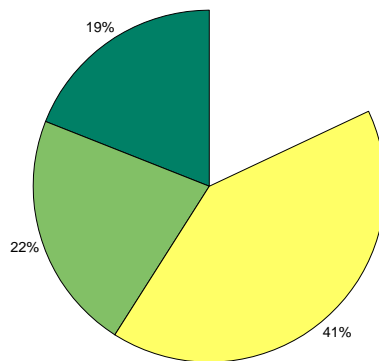

Histograms

MATLAB histogram functions show the distribution of data values. The functions that create histograms are `hist` and `rose`.

Function	Description
<code>hist</code>	Displays data in a Cartesian coordinate system
<code>rose</code>	Displays data in a polar coordinate system

The histogram functions count the number of elements within a range and display each range as a rectangular bin. The height (or length when using `rose`) of the bins represents the number of values that fall within each range.

Histograms in Cartesian Coordinate Systems

The `hist` function shows the distribution of the elements in `Y` as a histogram with equally spaced bins between the minimum and maximum values in `Y`. If `Y` is a vector and is the only argument, `hist` creates up to 10 bins. For example,

```
yn = randn(10000,1);  
hist(yn)
```

generates 10,000 random numbers and creates a histogram with 10 bins distributed along the x -axis between the minimum and maximum values of `yn`.

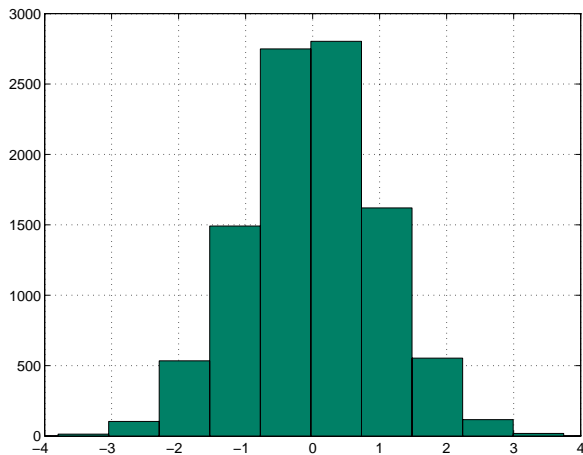

Matrix Input Argument

When Y is a matrix, `hist` creates a set of bins for each column, displaying each set in a separate color. The statements

```
Y = randn(10000,3);  
hist(Y)
```

create a histogram showing 10 bins for each column in Y .

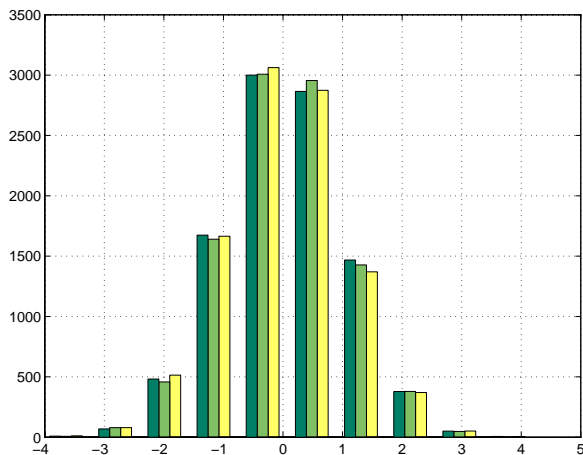

Histograms in Polar Coordinates

A rose plot is a histogram created in a polar coordinate system. For example, consider samples of the wind direction taken over a 12-hour period.

```
wdir = [45 90 90 45 360 335 360 270 335 270 335 335];
```

To display this data using the rose function, convert the data to radians, then use the data as an argument to the rose function. Increase the `LineWidth` property of the line to improve the visibility of the plot (`findobj`).

```
wdir = wdir * pi/180;
rose(wdir)
hline = findobj(gca, 'Type', 'line');
set(hline, 'LineWidth', 1.5)
```

The plot shows that the wind direction was primarily 335° during the 12-hour period.

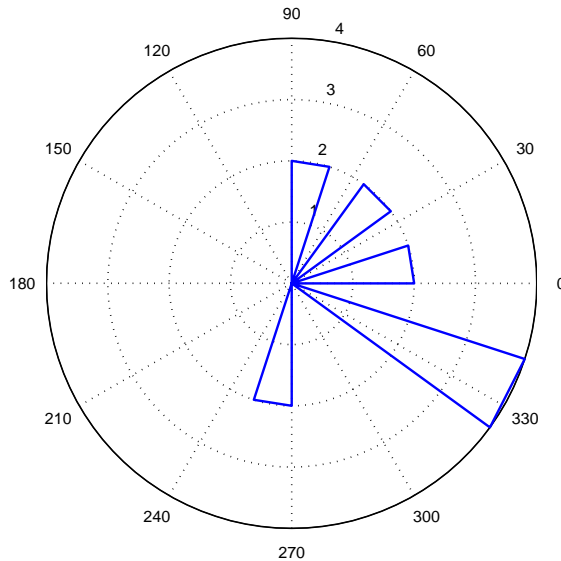

Specifying Number of Bins

`hist` and `rose` interpret their second argument in one of two ways — as the locations on the axis or the number of bins. When the second argument is a vector `x`, it specifies the locations on the axis and distributes the elements in `length(x)` bins. When the second argument is a scalar `x`, `hist` and `rose` distribute the elements in `x` bins.

For example, compare the distribution of data created by two MATLAB functions that generate random numbers. The `randn` function generates normally distributed random numbers, whereas the `rand` function generates uniformly distributed random numbers.

```
yn = randn(10000,1);
yu = rand(10000,1);
```

The first histogram displays the data distribution resulting from the `randn` function. The locations on the *x*-axis and number of bins depend on the vector `x`.

```
x = min(yn):.2:max(yn);
subplot(1,2,1)
```

```
hist(yn,x)
title('Normally Distributed Random Numbers','FontSize',16)
```

The second histogram displays the data distribution resulting from the rand function and explicitly creates 25 bins along the x -axis.

```
subplot(1,2,2)
hist(yu,25)
title('Uniformly Distributed Random Numbers','FontSize',16)
```

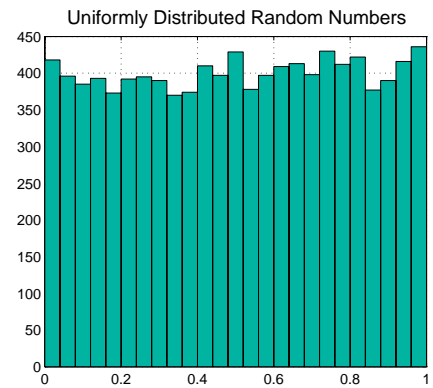
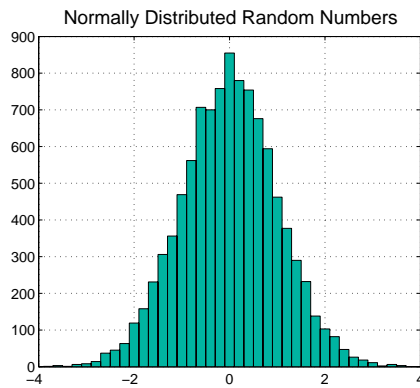

Note You can change the aspect ratio of the histogram plots using the mouse to resize the figure window. However, before creating hardcopy output, set the figure's `PaperPositionMode` to `auto` to produce printed output that matches the display.

```
set(gcf, 'PaperPositionMode', 'auto')
```

Discrete Data Graphs

MATLAB has a number of specialized functions that are appropriate for displaying discrete data. This section describes how to use stem plots and stairstep plots to display this type of data. (Bar charts, discussed earlier in this section, are also suitable for displaying discrete data.)

- “Two-Dimensional Stem Plots” on page 5-22 — Compares 2-D stem and line plots and shows techniques for customizing the stems
- “Combining Stem Plots with Line Plots” on page 5-25 — Combination line and stem plot with legend
- “Three-Dimensional Stem Plots” on page 5-26 — 3-D stem plot of an FFT and a combination 3-D stem and line plot
- “Stairstep Plots” on page 5-29 — Plotting a mathematical function with a stairstep plot

The following table lists the commands described in this section.

Function	Description
<code>stem</code>	Displays a discrete sequence of y -data as stems from x -axis
<code>stem3</code>	Displays a discrete sequence of z -data as stems from xy -plane
<code>stairs</code>	Displays a discrete sequence of y -data as steps from x -axis

Two-Dimensional Stem Plots

A stem plot displays data as lines (stems) terminated with a marker symbol at each data value. In a 2-D graph, stems extend from the x -axis.

The `stem` function displays two-dimensional discrete sequence data. For example, evaluating the function $y = e^{-\alpha t} \cos(\beta t)$ with the values

```
alpha = .02; beta = .5; t = 0:4:200;
y = exp(-alpha*t).*cos(beta*t);
```

yields a vector of discrete values for y at given values of t . A line plot shows the data points connected with a straight line.

```
plot(t,y)
```

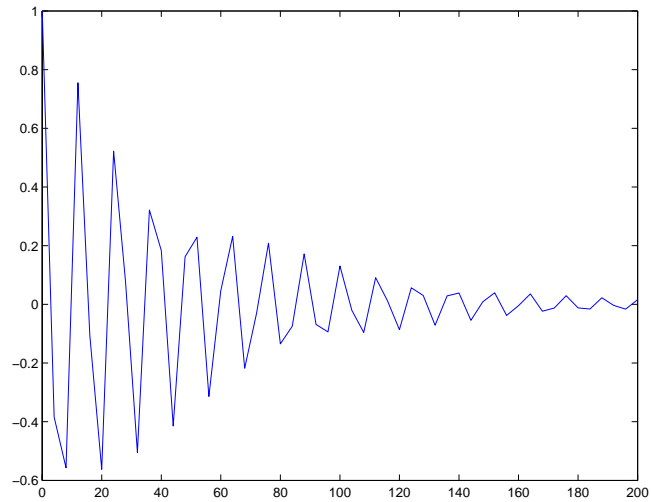

A stem plot of the same function plots only discrete points on the curve.

`stem(t,y)`

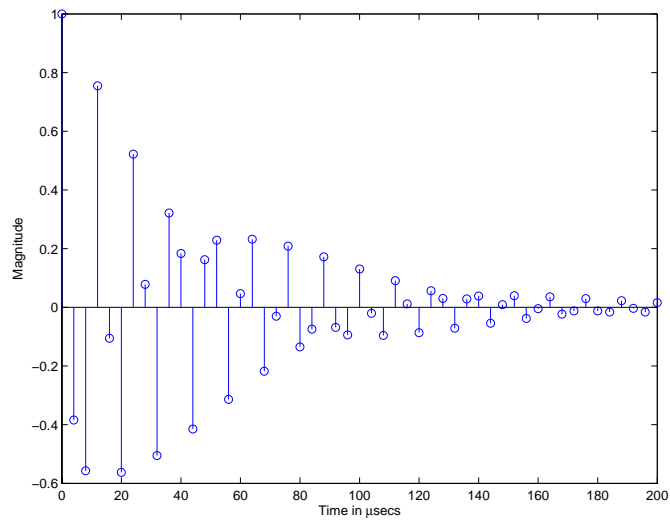

Add axes labels to the x - and y -axis.

```
xlabel('Time in \musecs')  
ylabel('Magnitude')
```

If you specify only one argument, the number of samples is equal to the length of that argument. In this example, the number of samples is a function of t , which contains 51 elements and determines the length of y .

Customizing the Graph

You can specify the line style, the type of marker, and the color used in the stem plot. For example, adding the string `'sr'` specifies a dotted line (`:`), a square marker (`s`), and a red color (`r`). The `'fill'` argument colors the face of the marker.

```
stem(t,y,'--sr','fill')
```

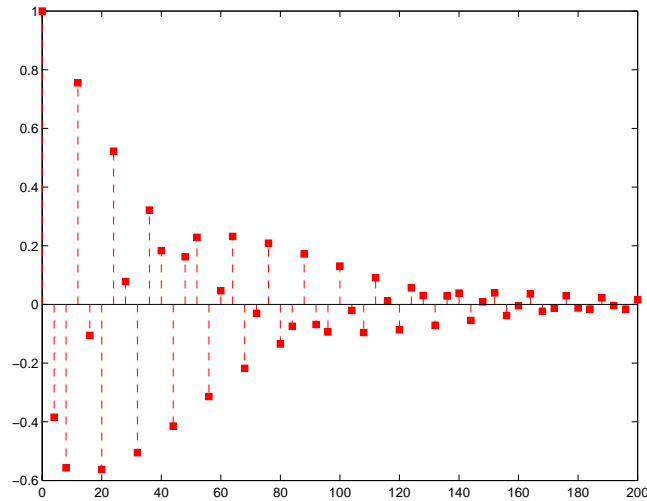

Setting the aspect ratio of the x - and y -axis to 2:1 improves the utility of the graph. You can do this by setting the aspect ratio of the plot box using `pbaspect`.

```
pbaspect([2,1,1])
```

This is equivalent to setting the `PlotBoxAspectRatio` property directly.

```
set(gca, 'PlotBoxAspectRatio', [2, 1, 1])
```

See `LineStyle` for a list of line styles and marker types.

Combining Stem Plots with Line Plots

Sometimes it is useful to display more than one plot simultaneously with a stem plot to show how you arrived at a result. For example, create a linearly spaced vector with 60 elements and define two functions, `a` and `b`.

```
x = linspace(0, 2*pi, 60);  
a = sin(x);  
b = cos(x);
```

Create a stem plot showing the linear combination of the two functions.

```
stem_handles = stem(x, a+b);
```

Overlying `a` and `b` as line plots helps visualize the functions. Before plotting the two curves, set `hold` to on so MATLAB does not clear the stem plot.

```
hold on  
plot_handles = plot(x, a, '--r', x, b, '--g');  
hold off
```

Use `legend` to annotate the graph. The stem and plot handles passed to `legend` identify the lines to label. Stem plots are composed of two lines; one draws the markers and the other draws the vertical stems. To create the legend, use the first handle returned by `stem`, which identifies the marker line.

```
legend_handles = [stem_handles(1); plot_handles];  
legend(legend_handles, 'a + b', 'a = sin(x)', 'b = cos(x)')
```

Labeling the axes and creating a title finishes the graph.

```
xlabel('Time in \musecs')  
ylabel('Magnitude')  
title('Linear Combination of Two Functions')
```

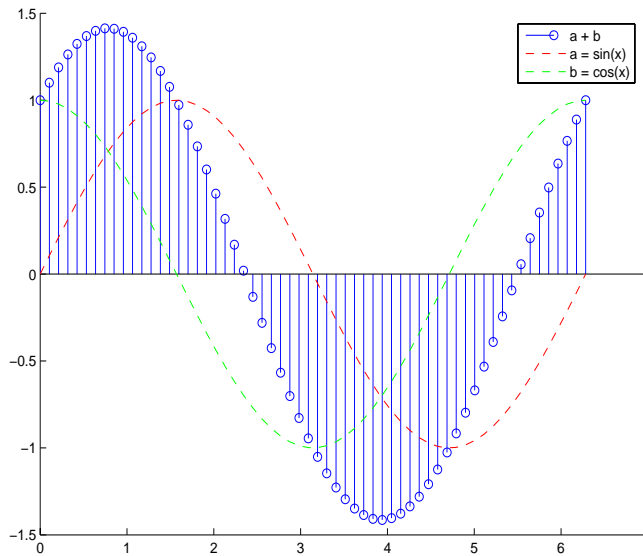

Three-Dimensional Stem Plots

`stem3` displays 3-D stem plots extending from the xy -plane. With only one vector argument, MATLAB plots the stems in one row at $x = 1$ or $y = 1$, depending on whether the argument is a column or row vector. `stem3` is intended to display data that you cannot visualize in a 2-D view.

Example – 3-D Stem Plot of an FFT

Fast Fourier transforms are calculated at points around the unit circle on the complex plane. So, it is interesting to visualize the plot around the unit circle. Calculating the unit circle

```
th = (0:127)/128*2*pi;
x = cos(th);
y = sin(th);
```

and the magnitude frequency response of a step function

```
f = abs(fft(ones(10,1),128));
```

displays the data using a 3-D stem plot, terminating the stems with filled diamond markers.

```
stem3(x,y,f,'d','fill')
view([-65 30])
```

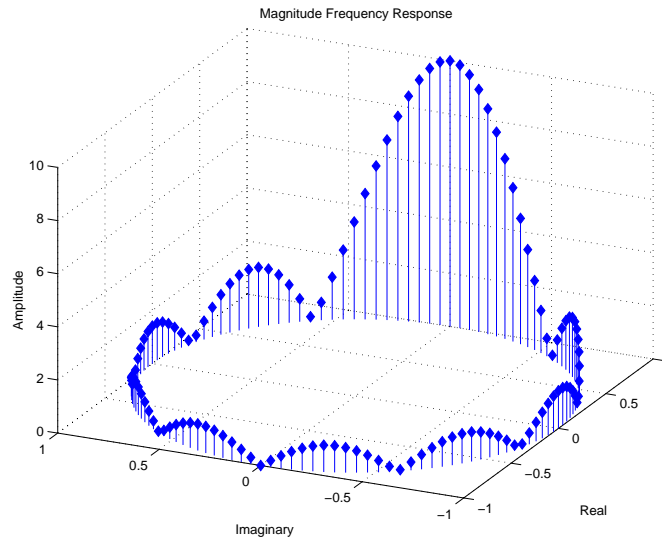

Label the Graph

Label the graph with the statements

```
xlabel('Real')
ylabel('Imaginary')
zlabel('Amplitude')
title('Magnitude Frequency Response')
```

To change the orientation of the view, turn on mouse-based 3-D rotation.

```
rotate3d on
```

Example — Combining Stem and Line Plots

Three-dimensional stem plots work well for visualizing discrete functions that do not output a large number of data points. For example, you can use `stem3` to

visualize the Laplace transform basis function, $y = e^{st}$, for a particular constant value of s .

```
t = 0:.1:10;% Time limits  
s = 0.1+i;% Spiral rate  
y = exp(-s*t);% Compute decaying exponential
```

Using t as magnitudes that increase with time, create a spiral with increasing height and draw a curve through the tops of the stems to improve definition.

```
stem3(real(y),imag(y),t)  
hold on  
plot3(real(y),imag(y),t,'r')  
hold off  
view(-39.5,62)
```

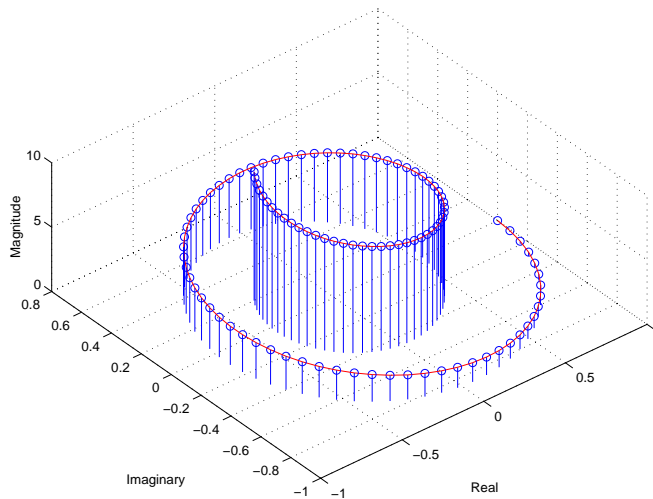

Label the Graph

Add axes labels, with the statements

```
xlabel('Real')  
ylabel('Imaginary')  
zlabel('Magnitude')
```

Stairstep Plots

Stairstep plots display data as the leading edges of a constant interval (i.e., zero-order hold state). This type of plot holds the data at a constant y -value for all values between $x(i)$ and $x(i+1)$, where i is the index into the x data. This type of plot is useful for drawing time-history plots of digitally sampled data systems.

Example — Stairstep Plot of a Function

Define a function f that varies over time,

```
alpha = 0.01;
beta = 0.5;
t = 0:10;
f = exp(-alpha*t).*sin(beta*t);
```

Use `stairs` to display the function as a stairstep plot and a linearly interpolated function.

```
stairs(t,f)
hold on
plot(t,f,'--*')
hold off
```

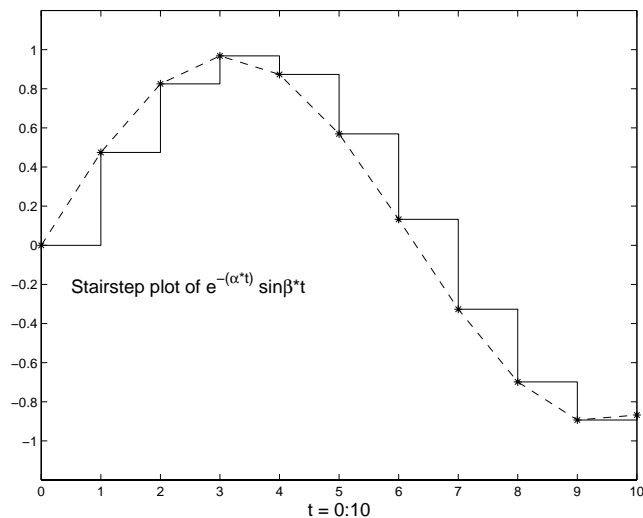

Annotate the graph and set the axes limits.

```
label = 'Stairstep plot of e^{-(\alpha*t)} sin\beta*t';  
text(0.5,-0.2,label,'FontSize',14)  
xlabel('t = 0:10','FontSize',14)  
axis([0 10 -1.2 1.2])
```

Direction and Velocity Vector Graphs

Several MATLAB functions display data consisting of direction vectors and velocity vectors. This section describes these functions.

Function	Description
compass	Displays vectors emanating from the origin of a polar plot
feather	Displays vectors extending from equally spaced points along a horizontal line
quiver	Displays 2-D vectors specified by (u,v) components
quiver3	Displays 3-D vectors specified by (u,v,w) components

You can define the vectors using one or two arguments. The arguments specify the x and y components of the vectors relative to the origin.

If you specify two arguments, the first specifies the x components of the vectors and the second the y components of the vectors. If you specify one argument, the functions treat the elements as complex numbers. The real parts are the x components and the imaginary parts are the y components.

Compass Plots

The compass function shows vectors emanating from the origin of a graph. The function takes Cartesian coordinates and plots them on a circular grid.

Example — Compass Plot of Wind Direction and Speed

This example shows a compass plot indicating the wind direction and strength during a 12-hour period. Two vectors define the wind direction and strength.

```
wdir = [45 90 90 45 360 335 360 270 335 270 335 335];
knots = [6 6 8 6 3 9 6 8 9 10 14 12];
```

Convert the wind direction, given as angles, into radians before converting the wind direction into Cartesian coordinates.

```
rdir = wdir * pi/180;
[x,y] = pol2cart(rdir,knots);
compass(x,y)
```

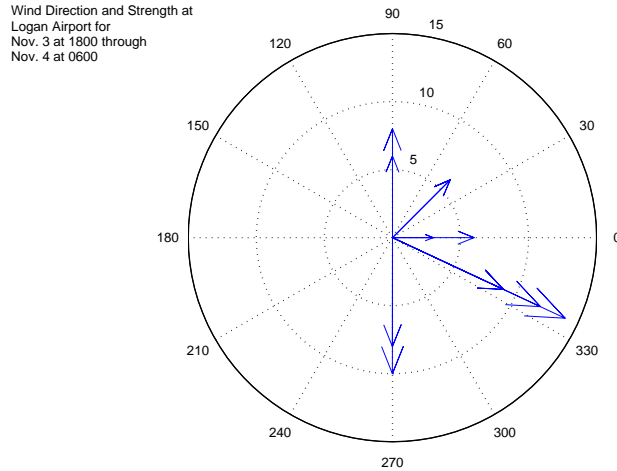

Create text to annotate the graph.

```
desc = {'Wind Direction and Strength at ',
        'Logan Airport for ',
        'Nov. 3 at 1800 through ',
        'Nov. 4 at 0600'};
text(-28,15,desc)
```

Feather Plots

The feather function shows vectors emanating from a straight line parallel to the x -axis. For example, create a vector of angles from 90° to 0° and a vector the same size, with each element equal to 1.

```
theta = 90:-10:0;
r = ones(size(theta));
```

Before creating a feather plot, transform the data into Cartesian coordinates and increase the magnitude of r to make the arrows more distinctive.

```
[u,v] = pol2cart(theta*pi/180,r*10);
feather(u,v)
axis equal
```

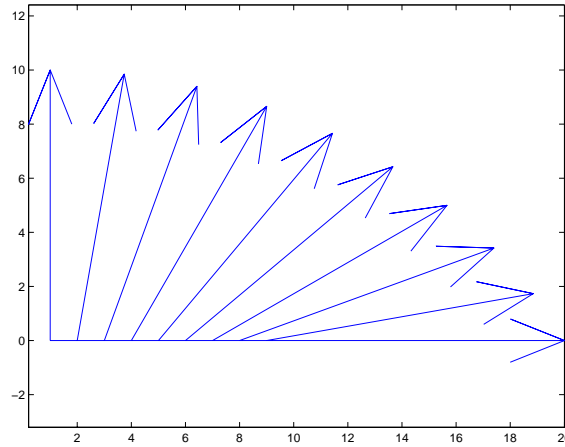
Plotting Complex Numbers

If the input argument Z is a matrix of complex numbers, `feather` interprets the real parts of Z as the x components of the vectors and the imaginary parts as the y components of the vectors.

```
t = 0:0.5:10;    % Time limits
s = 0.05+i;      % Spiral rate
Z = exp(-s*t);   % Compute decaying exponential
feather(Z)
```

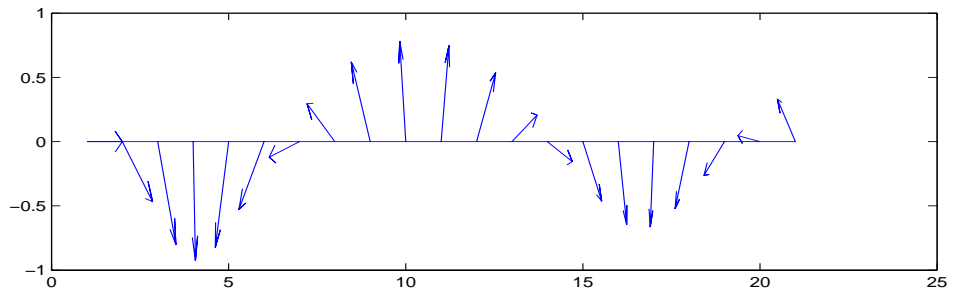

Printing the Graph

This particular graph looks better if you change the figure's aspect ratio by stretching the figure lengthwise using the mouse. However, to maintain this shape in the printed output, set the figure's `PaperPositionMode` to `auto`.

```
set(gcf, 'PaperPositionMode', 'auto')
```

In this mode, MATLAB prints the figure as it appears on screen.

Two-Dimensional Quiver Plots

The `quiver` function shows vectors at given points in two-dimensional space. The vectors are defined by x and y components.

A quiver plot is useful when displayed with another plot. For example, create 10 contours of the peaks function (see “Contour Plots” on page 5-37 for more information).

```
n = -2.0:.2:2.0;  
[X,Y,Z] = peaks(n);  
contour(X,Y,Z,10)
```

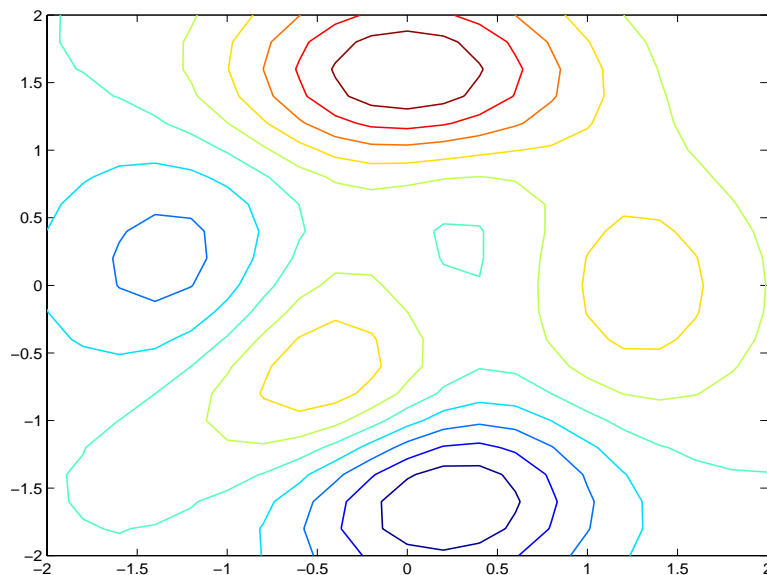

Now use gradient to create the vector components to use as inputs to quiver.

```
[U,V] = gradient(Z, .2);
```

Set hold to on and add the contour plot.

```
hold on
quiver(X,Y,U,V)
hold off
```

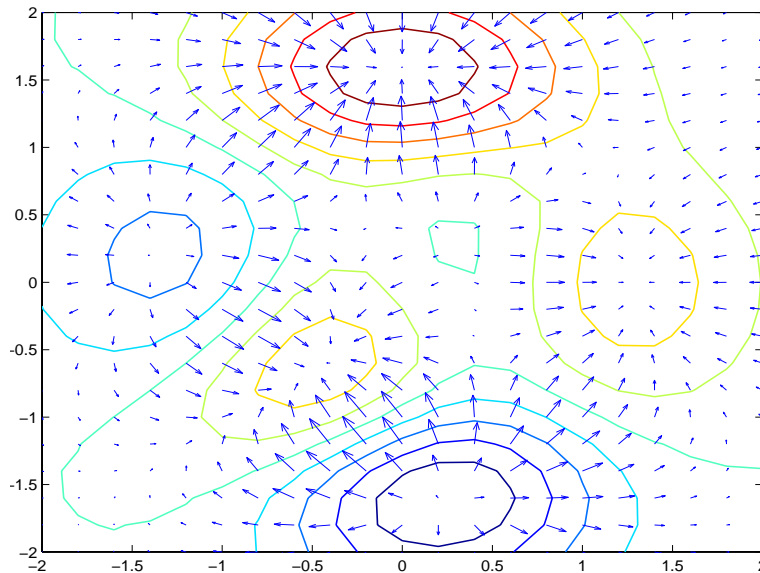

Three-Dimensional Quiver Plots

Three-dimensional quiver plots (`quiver3`) display vectors consisting of (u,v,w) components at (x,y,z) locations. For example, you can show the path of a projectile as a function of time,

$$z(t) = v_z t + \frac{at^2}{2}$$

First, assign values to the constants v_z and a .

```
vz = 10;           % Velocity
a = 32;            % Acceleration
```

Then, calculate the height z , as time varies from 0 to 1 in increments of 0.1.

```
t = 0:.1:1;  
z = vz*t + 1/2*a*t.^2;
```

Calculate the position in the x and y directions.

```
vx = 2;  
x = vx*t;  
vy = 3;  
y = vy*t;
```

Compute the components of the velocity vectors and display the vectors using the 3-D quiver plot.

```
u = gradient(x);  
v = gradient(y);  
w = gradient(z);  
scale = 0;  
quiver3(x,y,z,u,v,w,scale)  
view([70 18])
```

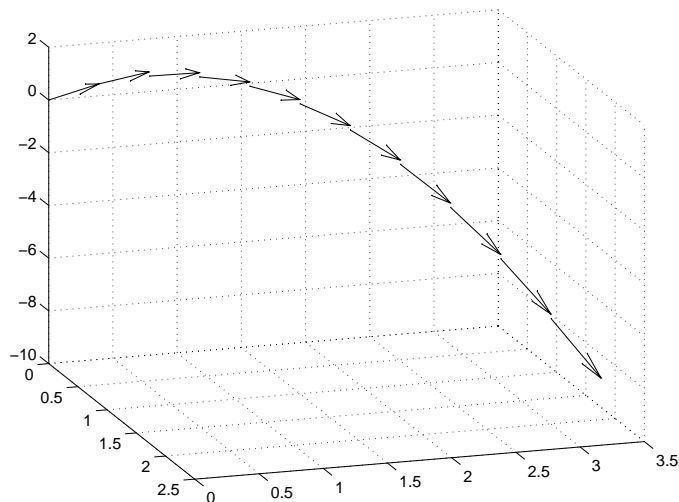

Contour Plots

The contour functions create, display, and label isolines determined by one or more matrices.

Function	Description
<code>clabel</code>	Generates labels using the contour matrix and displays the labels in the current figure
<code>contour</code>	Displays 2-D isolines generated from values given by a matrix Z
<code>contour3</code>	Displays 3-D isolines generated from values given by a matrix Z
<code>contourf</code>	Displays a 2-D contour plot and fills the area between the isolines with a solid color
<code>contourc</code>	Low-level function to calculate the contour matrix used by the other contour functions
<code>meshc</code>	Creates a mesh plot with a corresponding 2-D contour plot
<code>surf</code>	Creates a surface plot with a corresponding 2-D contour plot

Creating Simple Contour Plots

`contour` and `contour3` display 2- and 3-D contours, respectively. They require only one input argument — a matrix interpreted as heights with respect to a plane. In this case, the contour functions determine the number of contours to display based on the minimum and maximum data values.

To explicitly set the number of contour levels displayed by the functions, you specify a second optional argument.

Contour Plot of the Peaks Function

The statements

```
[X,Y,Z] = peaks;  
contour(X,Y,Z,20)
```

display 20 contours of the peaks function in a 2-D view.

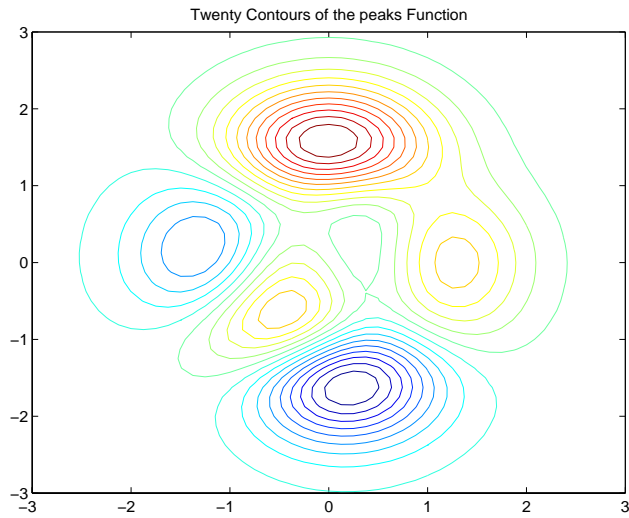

The statements

```
[X,Y,Z] = peaks;  
contour3(X,Y,Z,20)  
h = findobj('Type','patch');  
set(h,'LineWidth',2)  
title('Twenty Contours of the peaks Function')
```

display 20 contours of the peaks function in a 3-D view and increase the line width to 2 points.

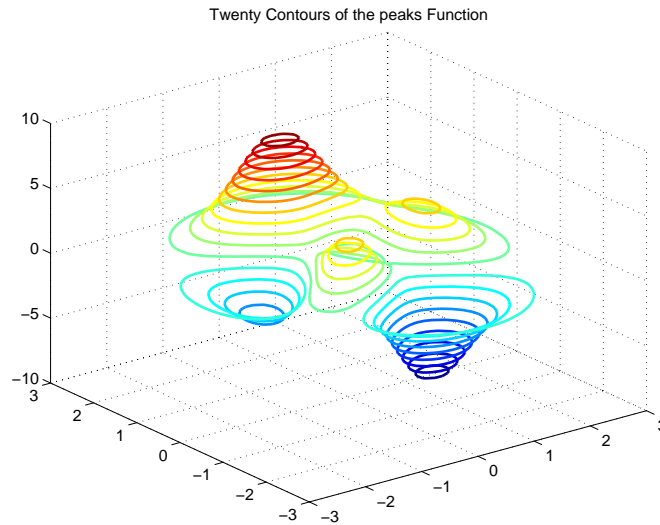

Labeling Contours

Each contour level has a value associated with it. `clabel` uses these values to display labels for 2-D contour lines. The contour matrix contains the values `clabel` uses for the labels. This matrix is returned by `contour`, `contour3`, and `contourf` and is described in “The Contouring Algorithm” on page 5-42.

`clabel` optionally returns the handles of the text objects used as labels. You can then use these handles to set the properties of the label string.

For example, display 10 contour levels of the peaks function,

```
Z = peaks;
[C,h] = contour(Z,10);
```

then label the contours and display a title.

```
clabel(C,h)
title({'Contour Labeled Using', 'clabel(C,h)'} )
```

Note that `clabel` labels only those contour lines that are large enough to have an inline label inserted.

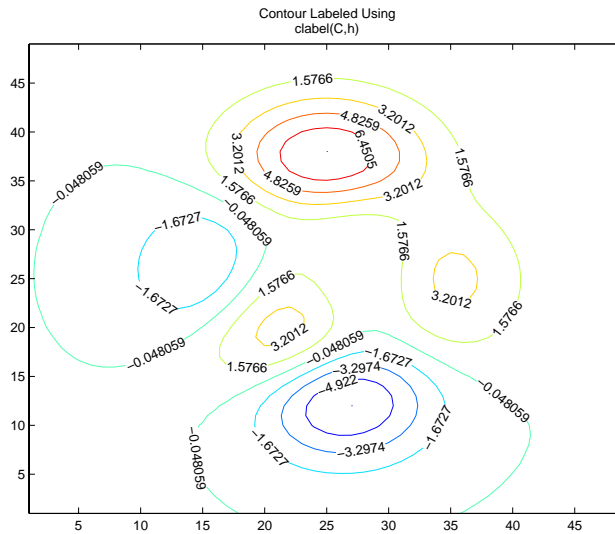

The 'manual' option enables you to add labels by selecting the contour you want to label with the mouse.

You can also use this option to label only those contours you select interactively.

For example,

```
clabel(C,h,'manual')
```

displays a crosshair cursor when your cursor is inside the figure. Pressing any mouse button labels the contour line closest to the center of the crosshair.

Filled Contours

contourf displays a two-dimensional contour plot and fills the areas between contour lines. Use `caxis` to control the mapping of contour to color. For example, this filled contour plot of the peaks data uses `caxis` to map the fill colors into the center of the colormap.

```
Z = peaks;
[C,h] = contourf(Z,10);
caxis([-20 20])
```



```
title({'Filled Contour Plot Using','contourf(Z,10)'})
```

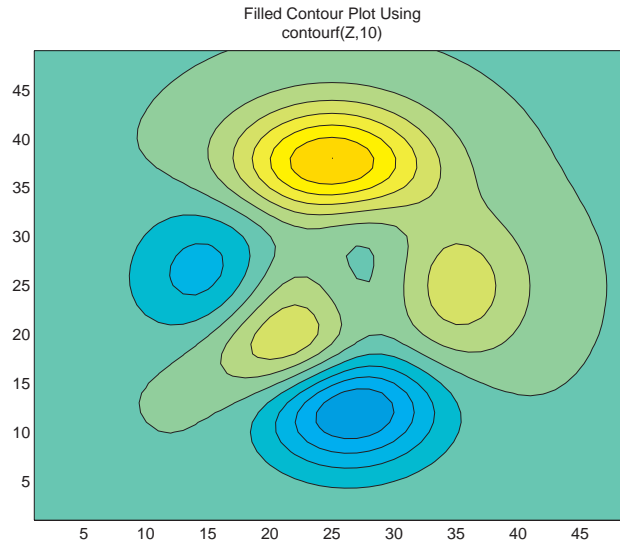

Drawing a Single Contour Line at a Desired Level

The contouring functions permit you to specify the number of contour levels or the particular contour levels to draw. In the case of `contour`, the two forms of the function are `contour(Z,n)` and `contour(Z,v)`. Z is the data matrix, n is the number of contour lines, and v is a vector of specific contour levels.

MATLAB does not differentiate between a scalar and a one-element vector. So, if v is a one-element vector specifying a single contour at that level, `contour` interprets it as the number of contour lines, not the contour level.

Consequently, `contour(Z,v)` behaves in the same manner as `contour(Z,n)`.

To display a single contour line, define v as a two-element vector with both elements equal to the desired contour level. For example, create a 3-D contour of the peaks function.

```
xrange = 3:.125:3;
yrange = xrange;
[X,Y] = meshgrid(xrange,yrange);
Z = peaks(X,Y);
```

```
contour3(X,Y,Z)
```

To display only one contour level at $Z = 1$, define v as $[1 \ 1]$.

```
v = [1 1]
contour3(X,Y,Z,v)
```

The Contouring Algorithm

The `contourc` function calculates the contour matrix for the other contour functions. It is a low-level function that is not called from the command line.

The contouring algorithm first determines which contour levels to draw. If you specified the input vector v , the elements of v are the contour level values, and `length(v)` determines the number of contour levels generated. If you do not specify v , the algorithm chooses no more than 20 contour levels that are divisible by 2 or 5.

The contouring algorithm treats the input matrix Z as a regularly spaced grid, with each element connected to its nearest neighbors. The algorithm scans this matrix comparing the values of each block of four neighboring elements (i.e., a cell) in the matrix to the contour level values. If a contour level falls within a cell, the algorithm performs a linear interpolation to locate the point at which the contour crosses the edges of the cell. The algorithm connects these points to produce a segment of a contour line.

`contour`, `contour3`, and `contourf` return a two-row matrix specifying all the contour lines. The format of the matrix is

```
C = [   value1   xdata(1)   xdata(2) ...
      numv     ydata(1)   ydata(2) ...]
```

The first row of the column that begins each definition of a contour line contains the value of the contour, as specified by v and used by `clabel`. Beneath that value is the number of (x,y) vertices in the contour line. Remaining

columns contain the data for the (x,y) pairs. For example, the contour matrix calculated by `C = contour(peaks(3))` is

Three vertices at $v = 0.2$	Columns 1 through 7	-0.2000	1.8165	2.0000	2.1835	0	1.0003	2.0000
		3.0000	1.0000	1.0367	1.0000	3.0000	1.0000	1.1998
Three vertices at $v = 0$	Columns 8 through 14	3.0000	0	1.0000	1.0359	1.0000	0.2000	1.6669
		1.0002	3.0000	2.9991	2.0000	1.0018	5.0000	3.0000
	Columns 15 through 21	1.2324	2.0000	2.8240	2.3331	0.4000	2.0000	2.6130
		2.0000	1.3629	2.0000	3.0000	5.0000	2.8530	2.0000
	Columns 22 through 28	2.0000	1.4290	2.0000	0.6000	2.0000	2.4020	2.0000
		1.5261	2.0000	2.8530	5.0000	2.5594	2.0000	1.6892
Five vertices at $v = 0.8$	Columns 29 through 35	1.6255	2.0000	0.8000	2.0000	2.1910	2.0000	1.8221
		2.0000	2.5594	5.0000	2.2657	2.0000	1.8524	2.0000
	Column 36	2.0000						
		2.2657						

The circled values begin each definition of a contour line.

Changing the Offset of a Contour

The `surf` and `meshc` functions display contours beneath a surface or a mesh plot. These functions draw the contour plot at the axes' minimum z -axis limit. To specify your own offset, you must change the `ZData` values of the contour lines. First, save the handles of the graphics objects created by `meshc` or `surf`.

```
h = meshc(peaks(20));
```

The first handle belongs to the mesh or surface. The remaining handles belong to the contours you want to change. To raise the contour plane, add 2 to the z coordinate of each contour line.

```
for i = 2:length(h);
```

```
        newz = get(h(i), 'Zdata') + 2;  
        set(h(i), 'Zdata', newz)  
    end
```

Displaying Contours in Polar Coordinates

You can contour data defined in the polar coordinate system. As an example, set up a grid in polar coordinates and convert the coordinates to Cartesian coordinates.

```
[th,r] = meshgrid((0:5:360)*pi/180,0:.05:1);  
[X,Y] = pol2cart(th,r);
```

Then generate the complex matrix Z on the interior of the unit circle.

```
Z = X+i*Y;
```

X , Y , and Z are points inside the circle.

Create and display a surface of the function $\sqrt{Z^4 + 1}$.

```
f = (Z.^4 + 1).^(1/4);  
surf(X,Y,abs(f))
```

Display the unit circle beneath the surface using the statements

```
hold on  
surf(X,Y,zeros(size(X)))  
hold off
```

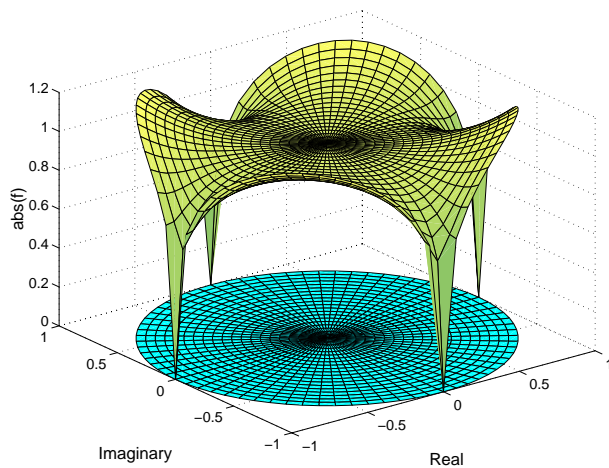

Labeling the Graph

These statements add labels.

```
xlabel('Real','FontSize',14);  
ylabel('Imaginary','FontSize',14);  
zlabel('abs(f)','FontSize',14);
```

Contours in Cartesian Coordinates

These statements display a contour of the surface in Cartesian coordinates and label the x - and y -axis.

```
contour(X,Y,abs(f),30)  
axis equal  
xlabel('Real','FontSize',14);  
ylabel('Imaginary','FontSize',14);
```

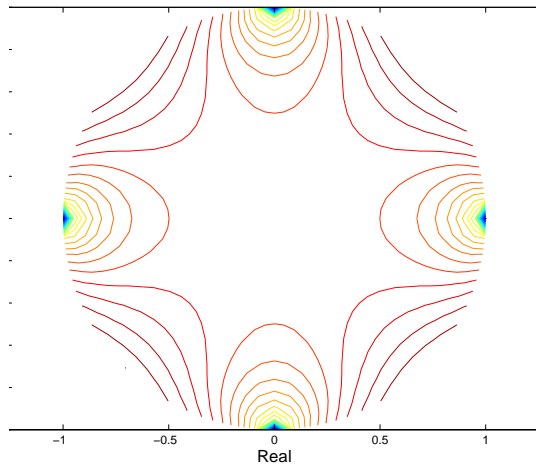

Contours on a Polar Axis

You can also display the contour within a polar axes. Create a polar axes using the `polar` function, and then delete the line specified with `polar`.

```
h = polar([0 2*pi], [0 1]);  
delete(h)
```

With `hold on`, display the contour on the polar grid.

```
hold on  
contour(X,Y,abs(f),30)
```

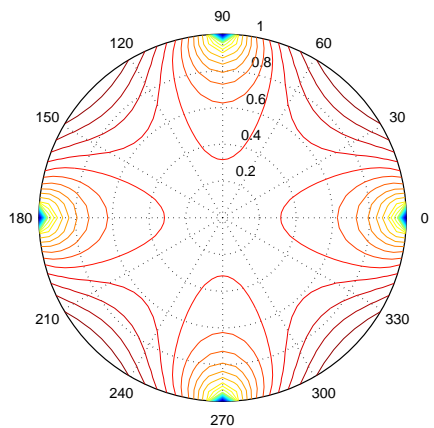

Interactive Plotting

The `ginput` function enables you to use the mouse or the arrow keys to select points to plot. `ginput` returns the coordinates of the pointer's position, either the current position or the position when a mouse button or key is pressed. See the `ginput` function for more information.

Example — Selecting Plotting Points from the Screen

This example illustrates the use of `ginput` with the `spline` function to create a curve by interpolating in two dimensions.

First, select a sequence of points, $[x,y]$, in the plane with `ginput`. Then pass two one-dimensional splines through the points, evaluating them with a spacing one-tenth of the original spacing.

```
axis([0 10 0 10])
hold on
% Initially, the list of points is empty.
xy = [];
n = 0;
% Loop, picking up the points.
disp('Left mouse button picks points.')
disp('Right mouse button picks last point.')
but = 1;
while but == 1
    [xi,yi,but] = ginput(1);
    plot(xi,yi,'ro')
    n = n+1;
    xy(:,n) = [xi;yi];
end
% Interpolate with a spline curve and finer spacing.
t = 1:n;
ts = 1: 0.1: n;
xys = spline(t,xy,ts);

% Plot the interpolated curve.
plot(xys(1,:),xys(2:,:), 'b-');
hold off
```

This plot shows some typical output.

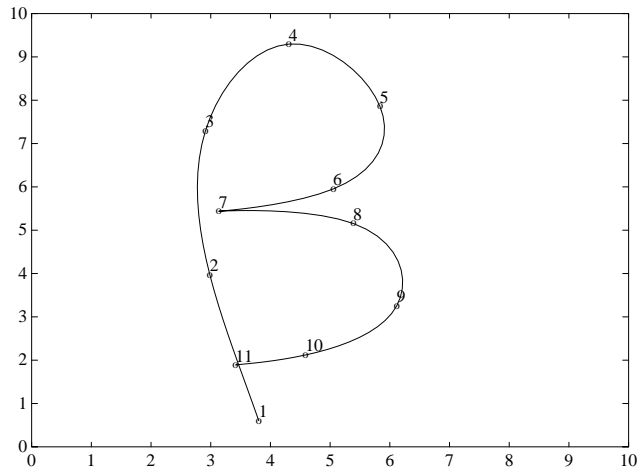

Animation

You can create animated sequences with MATLAB in two different ways:

- Save a number of different pictures and then play them back as a movie.
- Continually erase and then redraw the objects on the screen, making incremental changes with each redraw.

Movies are better suited to situations where each frame is fairly complex and cannot be redrawn rapidly. You create each movie frame in advance so the original drawing time is not important during playback, which is just a matter of blitting the frame to the screen. A movie is not rendered in real time; it is simply a playback of previously rendered frames.

The second technique, drawing, erasing, and then redrawing, makes use of different drawing modes supported by MATLAB. These modes allow faster redrawing at the expense of some rendering accuracy, so you must consider which mode to select.

This section provides an example of each technique. To see more sophisticated demonstrations of these features, type `demo` at the MATLAB prompt and explore the animation demonstrations.

Movies

You can save any sequence of graphs and then play the sequence back in a short movie. There are two steps to this process:

- Use `getframe` to generate each movie frame.
- Use `movie` to run the movie a specified number of times at the specified rate.

Typically, you use `getframe` in a `for` loop to assemble the array of movie frames. `getframe` returns a structure having the following fields:

- `cdata` — Image data in a `uint8` matrix. The matrix has dimensions of height-by-width on indexed-color systems and height-by-width-by-3 on truecolor systems.
- `colormap` — The colormap in an `n-by-3` matrix, where `n` is the number of colors. On truecolor systems, the `colormap` field is empty.

See `image` for more information on images.

Example – Visualizing an FFT as a Movie

This example illustrates the use of movies to visualize the quantity $\text{fft}(\text{eye}(n))$, which is a complex n -by- n matrix whose elements are various powers of the n th root of unity, $\exp(i*2*\pi/n)$.

Creating the Movie

Create the movie in a for loop calling `getframe` to capture the graph. Since the `plot` command resets the axes properties, call `axis equal` within the loop before `getframe`.

```
for k = 1:16
    plot(fft(eye(k+16)))
    axis equal
    M(k) = getframe;
end
```

Running the Movie

After generating the movie, you can play it back any number of times. To play it back 30 times, type

```
movie(M,30)
```

You can readily generate and smoothly play back movies with a few dozen frames on most computers. Longer movies require large amounts of primary memory or a very effective virtual memory system.

Movies that Include the Entire Figure

If you want to capture the contents of the entire figure window (for example, to include GUI components in the movie), specify the figure's handle as an argument to the `getframe` command. For example, suppose you want to add a slider to indicate the value of k in the previous example.

```
h = uicontrol('style','slider','position',...
    [10 50 20 300],'Min',1,'Max',16,'Value',1)
for k = 1:16
    plot(fft(eye(k+16)))
    axis equal
    set(h,'Value',k)
    M(k) = getframe(gcf);
end
```

In this example, the movie frame contains the entire figure. To play so that it looks like the original figure, make the playback axes fill the figure window.

```
clf
axes('Position',[0 0 1 1])
movie(M,30)
```

Erase Modes

You can select the method MATLAB uses to redraw graphics objects. One event that causes MATLAB to redraw an object is changing the properties of that object. You can take advantage of this behavior to create animated sequences. A typical scenario is to draw a graphics object, then change its position by respecifying the x -, y -, and z -coordinate data by a small amount with each pass through a loop.

You can create different effects by selecting different erase modes. This section illustrates how to use the three modes that are useful for dynamic redrawing:

- none—MATLAB does not erase the objects when it is moved.
- background—MATLAB erases the object by redrawing it in the background color. This mode erases the object and anything below it (such as grid lines).
- xor—This mode erases only the object and is usually used for animation.

All three modes are faster (albeit less accurate) than the normal mode used by MATLAB.

Example — Animating with Erase Modes

It is often interesting and informative to see 3-D trajectories develop in time. This example involves chaotic motion described by a nonlinear differential equation known as the Lorenz strange attractor. It can be written

in the form \dot{y}

with a vector-valued function $y(t)$ and a matrix A that depends upon y .

$$A(y) \begin{bmatrix} 8 \\ 3 \end{bmatrix}$$

The solution orbits about two different attractive points without settling into a steady orbit about either. This example approximates the solution with the simplest possible numerical method — Euler’s method with fixed step size. The result is not very accurate, but it has the same qualitative behavior as other methods.

```
A = [ -8/3 0 0; 0 -10 10; 0 28 -1 ];
y = [35 -10 -7] ;
h = 0.01;
p = plot3(y(1),y(2),y(3),'.', ...
    'EraseMode','none','MarkerSize',5); % Set EraseMode to none
axis([0 50 -25 25 -25 25])
hold on
for i=1:4000
    A(1,3) = y(2);
    A(3,1) = -y(2);
    ydot = A*y;
    y = y + h*ydot;
    % Change coordinates
    set(p,'XData',y(1),'YData',y(2),'ZData',y(3))
    drawnow
    i=i+1;
end
```

The `plot3` statement sets `EraseMode` to `none`, indicating that the points already plotted should not be erased when the plot is redrawn. In addition, the handle of the plot object is saved. Within the `for` loop, a `set` statement references the plot object and changes its internally stored coordinates for the new location. While this manual cannot show the dynamically evolving output, this picture shows a snapshot.

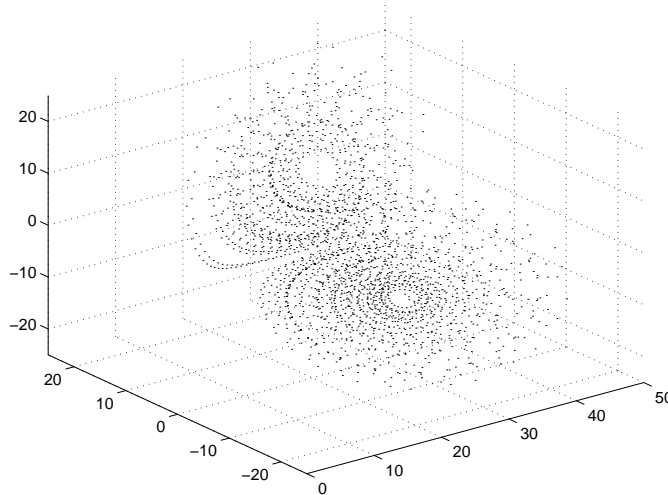

Note that, as far as MATLAB is concerned, the graph created by this example contains only one dot. What you see on the screen are remnants of previous plots that MATLAB has been instructed not to erase. The only way to print this graph from MATLAB is with a screen capture.

Background Erase Mode. To see the effect of `EraseMode` background, add these statements to the previous program.

```
p = plot3(y(1),y(2),y(3),'square', ...
    'EraseMode','background','MarkerSize',10,...
    'MarkerEdgeColor',[1 .7 .7],'MarkerFaceColor',[1 .7 .7]);

for i=1:4000
    A(1,3) = y(2);
    A(3,1) = -y(2);
    ydot = A*y;
    y = y + h*ydot;
    set(p,'XData',y(1),'YData',y(2),'ZData',y(3))
    drawnow
    i=i+1;
end
```

```
hold off
```

Since `hold` is still on, this code erases the previously created graph by setting the `EraseMode` property to `background` and changing the marker to a “pink eraser” (a square marker colored pink).

Xor Erase Mode. If you change the `EraseMode` of the first `plot3` statement from `none` to `xor`, you will see a moving dot (Marker ' . ') only. Xor mode is used to create animations where you do not want to leave remnants of previous graphics on the screen.

Additional Examples

The MATLAB demo `lorenz` provides a more accurate numerical approximation and a more elaborate display of the Lorenz strange attractor example. Other MATLAB demos illustrate animation techniques.

Displaying Bit-Mapped Images

Overview (p. 6-2)	File formats and image commands
Images in MATLAB (p. 6-4)	Specific information about images in MATLAB
Image Types (p. 6-6)	Types of images supported in MATLAB
Working with 8-Bit and 16-Bit Images (p. 6-11)	Operations you can perform on nondouble image data
Reading, Writing, and Querying Graphics Image Files (p. 6-17)	Working with standard image file formats in MATLAB
Displaying Graphics Images (p. 6-20)	Commands for displaying a matrix as an image
The Image Object and Its Properties (p. 6-25)	Properties of MATLAB image objects
Printing Images (p. 6-30)	Printing images in proper proportions
Converting the Data or Graphic Type of Images (p. 6-31)	Converting between image types

Overview

MATLAB provides commands for reading, writing, and displaying several types of graphics file formats for images. As with MATLAB-generated images, once a graphics file format image is displayed, it becomes a Handle Graphics image object. MATLAB supports the following graphics file formats:

- BMP (Microsoft Windows Bitmap)
- HDF (Hierarchical Data Format)
- JPEG (Joint Photographic Experts Group)
- PCX (Paintbrush)
- PNG (Portable Network Graphics)
- TIFF (Tagged Image File Format)
- XWD (X Window Dump)

For information concerning the bit depths and image types supported for these formats, see `imread` and `imwrite`.

MATLAB supports three different numeric classes for image display: double-precision floating-point (`double`), 16-bit unsigned integer (`uint16`), and 8-bit unsigned integer (`uint8`). The image display commands interpret data values differently depending on the numeric class the data is stored in.

This chapter discusses the different data and image types you can use, and includes details on how to read, write, work with, and display graphics images; how to alter the display properties and aspect ratio of an image during display; how to print an image; and how to convert the data type or graphics format of an image.

This table lists the functions discussed in this chapter.

Function	Purpose	Function Group
<code>axis</code>	Plot axis scaling and appearance	Display
<code>image</code>	Display image (create image object)	Display
<code>imagesc</code>	Scale data and display as image	Display
<code>imread</code>	Read image from graphics file	File I/O

Function	Purpose	Function Group
<code>imwrite</code>	Write image to graphics file	File I/O
<code>imfinfo</code>	Get image information from graphics file	Utility
<code>ind2rgb</code>	Convert indexed image to RGB image	Utility

Images in MATLAB

The basic data structure in MATLAB is the *array*, an ordered set of real or complex elements. This object is naturally suited to the representation of *images*, real-valued, ordered sets of color or intensity data. (MATLAB does not support complex-valued images.)

MATLAB stores most images as two-dimensional arrays (i.e., matrices), in which each element of the matrix corresponds to a single pixel in the displayed image. For example, an image composed of 200 rows and 300 columns of different colored dots would be stored in MATLAB as a 200-by-300 matrix. Some images, such as RGB, require a three-dimensional array, where the first plane in the third dimension represents the red pixel intensities, the second plane represents the green pixel intensities, and the third plane represents the blue pixel intensities.

This convention makes working with graphics file format images in MATLAB similar to working with any other type of matrix data. For example, you can select a single pixel from an image matrix using normal matrix subscripting.

```
I(2,15)
```

This command returns the value of the pixel at row 2, column 15 of the image I.

Bit Depth Support

MATLAB supports reading the most commonly used bit depths (bits per pixel) of any of the supported graphics file formats. When the data is in memory, it can be stored as `uint8`, `uint16`, or `double`. For details on which bit depths are appropriate for each supported format, see `imread` and `imwrite`.

Data Types

This section introduces you to the different data types that MATLAB uses to store images. Details on the inner workings of the storage for 8- and 16-bit images are included in “Working with 8-Bit and 16-Bit Images” on page 6-11.

By default, MATLAB stores most data in arrays of class `double`. The data in these arrays is stored as double-precision (64-bit) floating-point numbers. All MATLAB functions and capabilities work with these arrays.

For images stored in one of the graphics file formats supported by MATLAB, however, this data representation is not always ideal. The number of pixels in

such an image can be very large; for example, a 1000-by-1000 image has a million pixels. Since each pixel is represented by at least one array element, this image would require about 8 megabytes of memory if it were stored as class `double`.

To reduce memory requirements, MATLAB supports storing image data in arrays of class `uint8` and `uint16`. The data in these arrays is stored as 8-bit or 16-bit unsigned integers. These arrays require one-eighth or one-fourth as much memory as data in `double` arrays.

Image Types

In MATLAB, an image consists of a data matrix and possibly a colormap matrix. Three basic image types are used in MATLAB, each differing in the way that the data matrix elements are interpreted:

- Indexed images
- Intensity (or grayscale) images
- RGB (or truecolor) images

This section discusses how MATLAB represents each of these image types.

Indexed Images

An indexed image consists of a data matrix, X , and a colormap matrix, map . map is an m -by-3 array of class `double` containing floating-point values in the range $[0, 1]$. Each row of map specifies the red, green, and blue components of a single color. An indexed image uses “direct mapping” of pixel values to colormap values. The color of each image pixel is determined by using the corresponding value of X as an index into map . The value 1 points to the first row in map , the value 2 points to the second row, and so on. You can display an indexed image with the statements

```
image(X); colormap(map)
```

A colormap is often stored with an indexed image and is automatically loaded with the image when you use the `imread` function. However, you are not limited to using the default colormap—you can use any colormap that you choose. The description for the property `CDataMapping` describes how to alter the type of mapping used.

The next figure illustrates the structure of an indexed image. The pixels in the image are represented by integers, which are pointers (indices) to color values stored in the colormap.

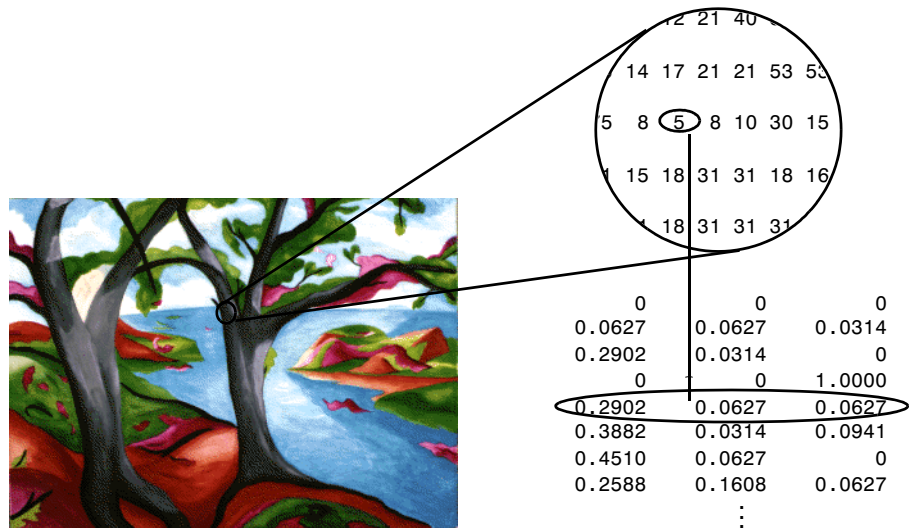

The relationship between the values in the image matrix and the colormap depends on the class of the image matrix. If the image matrix is of class `double`, the value 1 points to the first row in the colormap, the value 2 points to the second row, and so on. If the image matrix is of class `uint8` or `uint16`, there is an offset—the value 0 points to the first row in the colormap, the value 1 points to the second row, and so on. The offset is also used in graphics file formats, to maximize the number of colors that can be supported. In the image above, the image matrix is of class `double`. Because there is no offset, the value 5 points to the fifth row of the colormap.

Intensity Images

An intensity image is a data matrix, I , whose values represent intensities within some range. MATLAB stores an intensity image as a single matrix, with each element of the matrix corresponding to one image pixel. The matrix can be of class `double`, `uint8`, or `uint16`. While intensity images are rarely saved with a colormap, MATLAB uses a colormap to display them. In essence, MATLAB handles intensity images as indexed images.

This figure depicts an intensity image of class `double`.

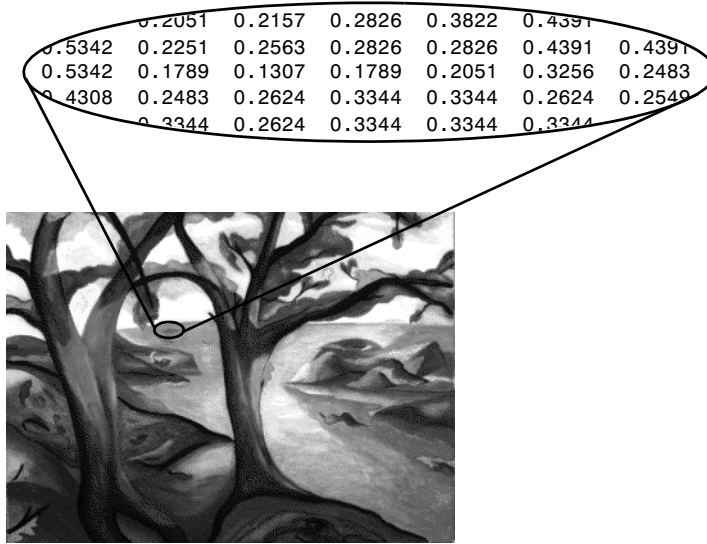

To display an intensity image, use the `imagesc` (“image scale”) function, which enables you to set the range of intensity values. `imagesc` scales the image data to use the full colormap. Use the two-input form of `imagesc` to display an intensity image. For example,

```
imagesc(I,[0 1]); colormap(gray);
```

The second input argument to `imagesc` specifies the desired intensity range. The function `imagesc` displays `I` by mapping the first value in the range (usually 0) to the first colormap entry, and the second value (usually 1) to the last colormap entry. Values in between are linearly distributed throughout the remaining colormap colors.

Although it is conventional to display intensity images using a grayscale colormap, it is possible to use other colormaps. For example, the following statements display the intensity image `I` in shades of blue and green.

```
imagesc(I,[0 1]); colormap(winter);
```

To display a matrix `A` with an arbitrary range of values as an intensity image, use the single-argument form of `imagesc`. With one input argument, `imagesc` maps the minimum value of the data matrix to the first colormap entry, and

maps the maximum value to the last colormap entry. For example, these two lines are equivalent.

```
imagesc(A); colormap(gray)
imagesc(A,[min(A(:)) max(A(:))]); colormap(gray)
```

RGB (Truecolor) Images

An RGB image, sometimes referred to as a “truecolor” image, is stored in MATLAB as an m -by- n -by-3 data array that defines red, green, and blue color components for each individual pixel. RGB images do not use a palette. The color of each pixel is determined by the combination of the red, green, and blue intensities stored in each color plane at the pixel’s location. Graphics file formats store RGB images as 24-bit images, where the red, green, and blue components are 8 bits each. This yields a potential of 16 million colors. The precision with which a real-life image can be replicated has led to the nickname “truecolor image.”

An RGB MATLAB array can be of class `double`, `uint8`, or `uint16`. In an RGB array of class `double`, each color component is a value between 0 and 1. A pixel whose color components are (0,0,0) is displayed as black, and a pixel whose color components are (1,1,1) is displayed as white. The three color components for each pixel are stored along the third dimension of the data array. For example, the red, green, and blue color components of the pixel (10,5) are stored in `RGB(10,5,1)`, `RGB(10,5,2)`, and `RGB(10,5,3)`, respectively.

To display the truecolor image `RGB`, use the `image` function. For example,

```
image(RGB)
```

The next figure shows an RGB image of class `double`.

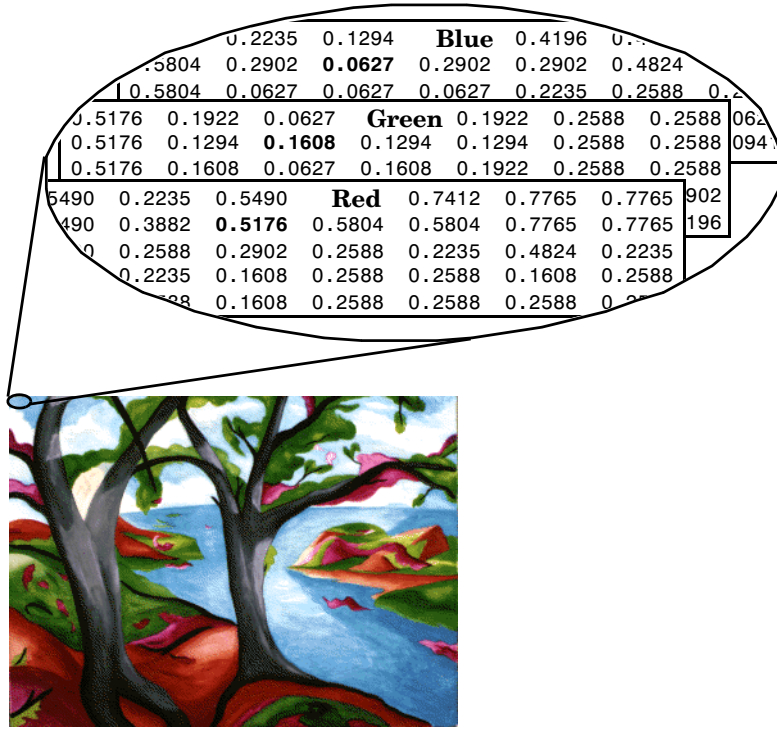

To determine the color of the pixel at (2,3), you would look at the RGB triplet stored in (2,3,1:3). Suppose (2,3,1) contains the value 0.5176, (2,3,2) contains 0.1608, and (2,3,3) contains 0.0627. The color for the pixel at (2,3) is

0.5176 0.1608 0.0627

Working with 8-Bit and 16-Bit Images

MATLAB usually works with double-precision (64-bit) floating-point numbers. However, to reduce memory requirements for working with images, MATLAB provides support for storing images as 8-bit or 16-bit unsigned integers by using the numeric classes `uint8` or `uint16`, respectively. An image whose data matrix has class `uint8` is called an 8-bit image; an image whose data matrix has class `uint16` is called a 16-bit image.

The `image` function can display 8- or 16-bit images directly without converting them to double precision. However, `image` interprets matrix values slightly differently when the image matrix is `uint8` or `uint16`. The specific interpretation depends on the image type.

8-Bit and 16-Bit Indexed Images

If the class of `X` is `uint8` or `uint16`, its values are offset by 1 before being used as `colormap` indices. The value 0 points to the first row of the `colormap`, the value 1 points to the second row, and so on. The `image` command automatically supplies the proper offset, so the display method is the same whether `X` is `double`, `uint8`, or `uint16`.

```
image(X); colormap(map);
```

The `colormap` index offset for `uint8` and `uint16` data is intended to support standard graphics file formats, which typically store image data in indexed form with a 256-entry `colormap`. The offset allows you to manipulate and display images of this form in MATLAB using the more memory-efficient `uint8` and `uint16` arrays.

Because of the offset, you must add 1 to convert a `uint8` or `uint16` indexed image to `double`. For example,

```
X64 = double(X8) + 1;  
or  
X64 = double(X16) + 1;
```

Conversely, subtract 1 to convert a `double` indexed image to `uint8` or `uint16`.

```
X8 = uint8(X64 - 1);  
or  
X16 = uint16(X64 - 1);
```

8-Bit and 16-Bit Intensity Images

Whereas the range of double image arrays is usually [0, 1], the range of 8-bit intensity images is usually [0, 255] and the range of 16-bit intensity images is usually [0, 65535]. Use the following command to display an 8-bit intensity image with a grayscale colormap.

```
imagesc(I,[0 255]); colormap(gray);
```

To convert an intensity image from double to uint16, first multiply by 65535.

```
I16 = uint16(round(I64*65535));
```

Conversely, divide by 65535 after converting a uint16 intensity image to double.

```
I64 = double(I16)/65535;
```

8-Bit and 16-Bit RGB Images

The color components of an 8-bit RGB image are integers in the range [0, 255] rather than floating-point values in the range [0, 1]. A pixel whose color components are (255,255,255) is displayed as white. The image command displays an RGB image correctly whether its class is double, uint8, or uint16.

```
image( RGB );
```

To convert an RGB image from double to uint8, first multiply by 255.

```
RGB8 = uint8(round(RGB64*255));
```

Conversely, divide by 255 after converting a uint8 RGB image to double.

```
RGB64 = double(RGB8)/255
```

To convert an RGB image from double to uint16, first multiply by 65535.

```
RGB16 = uint16(round(RGB64*65535));
```

Conversely, divide by 65535 after converting a uint16 RGB image to double.

```
RGB64 = double(RGB16)/65535;
```

Mathematical Operations Support for uint8 and uint16

To use the following MATLAB functions with `uint8` and `uint16` data, first convert the data to type `double`: `conv2`, `convn`, `fft2`, `fftn`. For example, if `X` is a `uint8` image, cast the data to type `double`:

```
fft(double(X))
```

In these cases, the output is always `double`.

The `sum` function returns results in the same type as its input, but provides an option to use double precision for calculations.

Integer Mathematics in MATLAB

See “Integer Mathematics” in the MATLAB Math documentation for more information on how mathematical functions work with data types that are not `doubles`.

Most of the functions in the Image Processing Toolbox accept `uint8` and `uint16` input. If you plan to do sophisticated image processing on `uint8` or `uint16` data, you should consider adding the Image Processing Toolbox to your MATLAB computing environment.

Other 8-Bit and 16-Bit Array Support

MATLAB supports several other operations on `uint8` and `uint16` arrays, including

- Reshaping, reordering, and concatenating arrays using the functions `reshape`, `cat`, `permute`, and the `[]` and `'` operators
- Saving and loading `uint8` and `uint16` arrays in MAT-files using `save` and `load`. (Remember that if you are loading or saving a graphics file format image, you must use the commands `imread` and `imwrite` instead.)
- Locating the indices of nonzero elements in `uint8` and `uint16` arrays using `find`. However, the returned array is always of class `double`.
- Relational operators

Converting an 8-Bit RGB Image to Grayscale

MATLAB can perform arithmetic operations on integer data, which enables you to convert image types without first converting the numeric class of the image data.

This example reads an 8-bit RGB image into MATLAB and converts it to a grayscale image.

```
rgb_img = imread('ngc6543a.jpg'); % Load the image
image(rgb_img) % Display the RGB image
```

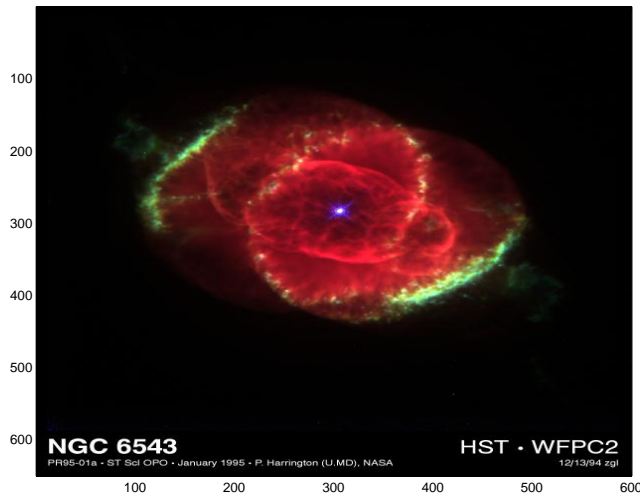

Now calculate the monochrome luminance by combining the RGB values according to the NTSC standard, which applies coefficients related to the eye's sensitivity to RGB colors.

```
I = .2989*rgb_img(:,:,1)...
    +.5870*rgb_img(:,:,2)...
    +.1140*rgb_img(:,:,3);
```

I is an intensity image with integer values ranging from a minimum of zero,

```
min(I(:))
ans =
    0
```

to a maximum of 255,

```
max(I(:))
ans =
    255
```

To display the image, use a grayscale colormap with 256 values. This avoids the need to scale the data-to-color mapping, which would be required if you used a colormap of a different size. You can use the `imagesc` function in cases where the colormap does not contain one entry for each data value.

Now display the image in a new figure using the gray colormap.

```
figure; colormap(gray(256)); image(I)
```

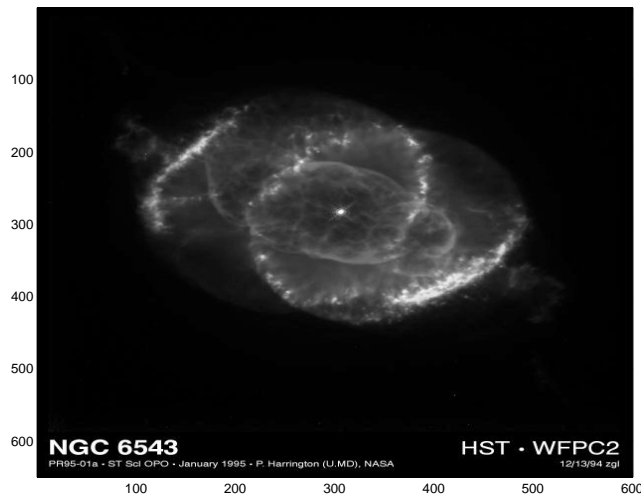

Related Information

Other colormaps with a range of colors that vary continuously from dark to light can produce usable images. For example, try `colormap(summer(256))` for a classic oscilloscope look. See `colormap` for more choices.

The `brighten` function enables you to increase or decrease the color intensities in a colormap to compensate for computer display differences or to enhance the visibility of faint or bright regions of the image (at the expense of the opposite end of the range).

Summary of Image Types and Numeric Classes

This table summarizes the way MATLAB interprets data matrix elements as pixel colors, depending on the image type and data class.

Image Type	double Data	uint8 or uint16 Data
Indexed	Image is an m -by- n array of integers in the range $[1, p]$. Colormap is a p -by-3 array of floating-point values in the range $[0, 1]$.	Image is an m -by- n array of integers in the range $[0, p - 1]$. Colormap is a p -by-3 array of floating-point values in the range $[0, 1]$.
Intensity	Image is an m -by- n array of floating-point values that are linearly scaled by MATLAB to produce colormap indices. Typical range of values is $[0, 1]$. Colormap is a p -by-3 array of floating-point values in the range $[0, 1]$ and is typically grayscale.	Image is an m -by- n array of integers that are linearly scaled by MATLAB to produce colormap indices. The typical range of values is $[0, 255]$ or $[0, 65535]$. Colormap is a p -by-3 array of floating-point values in the range $[0, 1]$ and is typically grayscale.
RGB (Truecolor)	Image is an m -by- n -by-3 array of floating-point values in the range $[0, 1]$.	Image is an m -by- n -by-3 array of integers in the range $[0, 255]$ or $[0, 65535]$.

Reading, Writing, and Querying Graphics Image Files

In its native form, a graphics file format image is not stored as a MATLAB matrix, or even necessarily as a matrix. Most graphics files begin with a header containing format-specific information tags, and continue with bitmap data that can be read as a continuous stream. For this reason, you cannot use the standard MATLAB I/O commands `load` and `save` to read and write a graphics file format image.

MATLAB provides special functions for reading and writing image data from graphics file formats. To read a graphics file format image use `imread`; to write a graphics file format image, use `imwrite`; to obtain information about the nature of a graphics file format image, use `imfinfo`.

This table gives a clearer picture of which MATLAB commands should be used with which image types.

Procedure	Functions to Use
Load or Save a Matrix as a MAT-file	<code>load</code> <code>save</code>
Load or Save Graphics File Format Image, e.g. BMP, TIFF	<code>imread</code> <code>imwrite</code>
Display Any Image Loaded Into MATLAB	<code>image</code> <code>imagesc</code>
Utilities	<code>imfinfo</code> <code>ind2rgb</code>

Reading a Graphics Image

The function `imread` reads an image from any supported graphics image file in any of the supported bit depths. Most of the images that you will read are 8-bit. When these are read into memory, MATLAB stores them as class `uint8`. The main exception to this rule is that MATLAB supports 16-bit data for PNG and TIFF images. If you read a 16-bit PNG or TIFF image, it is stored as class `uint16`.

Note For indexed images, `imread` always reads the colormap into an array of class `double`, even though the image array itself can be of class `uint8` or `uint16`.

The following statement reads the image `ngc6543a.jpg` into the workspace variable `RGB` and then displays the image using the `image` function.

```
RGB = imread('ngc6543a.jpg');  
image(RGB)
```

You can write (save) image data using the `imwrite` function. The statements

```
load clown % An image that is included with MATLAB  
imwrite(X,map,'clown.bmp')
```

create a BMP file containing the clown image.

Writing a Graphics Image

When you save an image using `imwrite`, the default behavior is to automatically reduce the bit depth to `uint8`. Many of the images used in MATLAB are 8-bit, and most graphics file format images do not require double-precision data. One exception to the MATLAB rule for saving the image data as `uint8` is that PNG and TIFF images can be saved as `uint16`. Because these two formats support 16-bit data, you can override the MATLAB default behavior by specifying `uint16` as the data type for `imwrite`. The following example shows writing a 16-bit PNG file using `imwrite`.

```
imwrite(I,'clown.png','BitDepth',16);
```

Obtaining Information About Graphics Files

The `imfinfo` function enables you to obtain information about graphics files that are in any of the standard formats listed above. The information you obtain depends on the type of file, but it always includes at least the following:

- Name of the file, including the directory path if the file is not in the current directory
- File format
- Version number of the file format

- File modification date
- File size in bytes
- Image width in pixels
- Image height in pixels
- Number of bits per pixel
- Image type: RGB (truecolor), intensity (grayscale), or indexed

Displaying Graphics Images

To display a graphics file image, use either `image` or `imagesc`. For example, assuming `RGB` is an image,

```
figure('Position',[100 100 size(RGB,2) size(RGB,1)]);  
image(RGB); set(gca,'Position',[0 0 1 1])
```

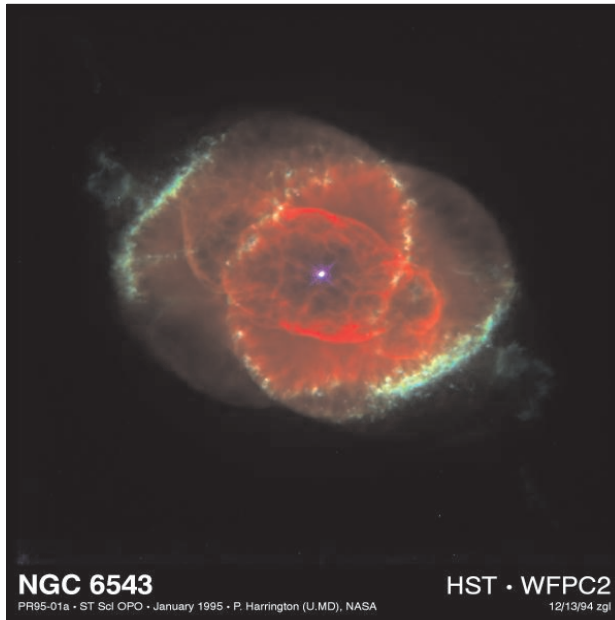

(This image was created with the support of the Space Telescope Science Institute, operated by the Association of Universities for Research in Astronomy, Inc., from NASA contract NAs5-26555, and is reproduced with permission from AURA/STScI. Digital renditions of images produced by AURA/STScI are obtainable royalty-free. Credits: J.P. Harrington and K.J. Orkowski (University of Maryland), and NASA.)

Summary of Image Types and Display Methods

This table summarizes display methods for the three types of images.

Image Type	Display Commands	Uses Colormap Colors
Indexed	<code>image(X); colormap(map)</code>	Yes
Intensity	<code>imagesc(I,[0 1]); colormap(gray)</code>	Yes
RGB (truecolor)	<code>image(RGB)</code>	No

Controlling Aspect Ratio and Display Size

The `image` function displays the image in a default-sized figure and axes. MATLAB stretches or shrinks the image to fit the display area. Sometimes you want the aspect ratio of the display to match the aspect ratio of the image data matrix. The easiest way to do this is with the command `axis image`.

For example, these commands display the earth image in the `demos` directory using the default figure and axes positions.

```
load earth
image(X); colormap(map)
```

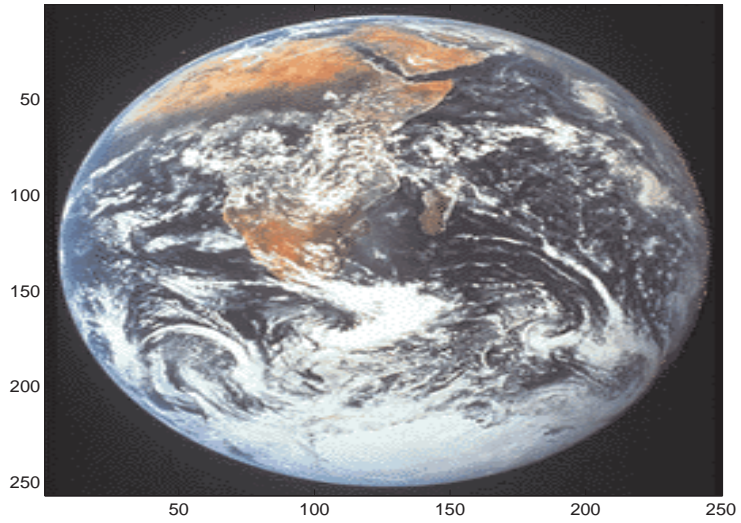

The elongated globe results from stretching the image display to fit the axes position. Use the `axis image` command to force the aspect ratio to be one-to-one.

```
axis image
```

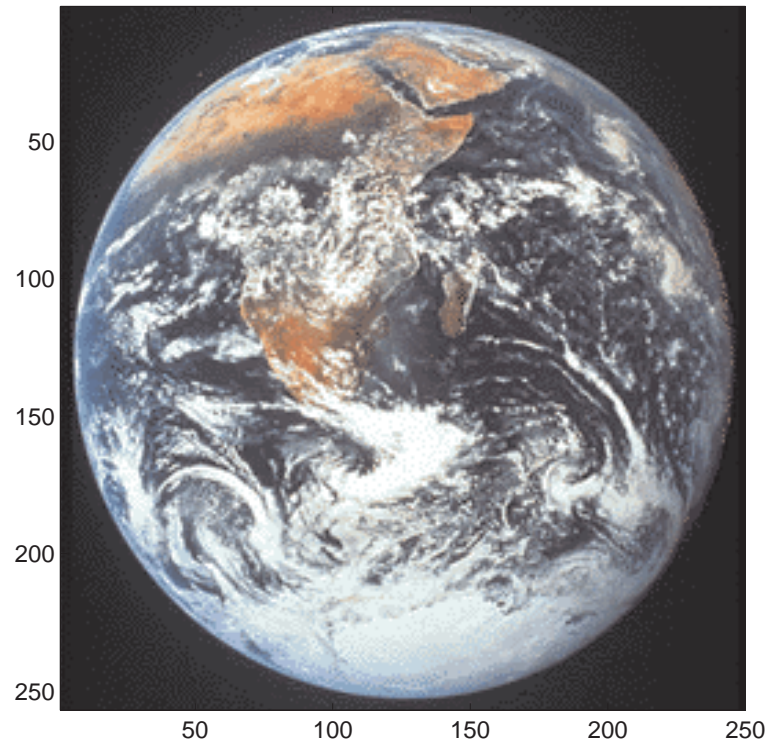

The command `axis image` works by setting the `DataAspectRatio` property of the axes object to `[1 1 1]`. See `axis` and `axes` for more information on how to control the appearance of axes objects.

Sometimes you might want to display an image so that each element in the data matrix corresponds to a single screen pixel. To display an image with this one-to-one matrix-element-to-screen-pixel mapping, you need to resize the figure and axes. For example, these commands display the earth image so that one data element corresponds to one screen pixel.

```
[m,n] = size(X);  
figure('Units','pixels','Position',[100 100 n m])  
image(X); colormap(map)  
set(gca,'Position',[0 0 1 1])
```

The figure's `Position` property is a four-element vector that specifies the figure's location on the screen as well as its size. The second statement above positions the figure so that its lower left corner is at position (100,100) on the screen and so that its width and height match the image width and height. Setting the axes position to [0 0 1 1] in normalized units creates an axes that fills the figure. The resulting picture is shown.



The Image Object and Its Properties

The commands `image` and `imagesc` create image objects. Image objects are children of axes objects, as are line, patch, surface, and text objects. Like all Handle Graphics objects, the image object has a number of properties you can set to fine-tune its appearance on the screen. The most important properties of the image object with respect to appearance are `CData`, `CDataMapping`, `XData`, `YData`, and `EraseMode`. For detailed information about these and all the properties of the image object, see `image`.

Image CData

The `CData` property of an image object contains the data array. In the commands below, `h` is the handle of the image object created by `image`, and the matrices `X` and `Y` are the same.

```
h = image(X); colormap(map)
Y = get(h, 'CData');
```

The dimensionality of the `CData` array controls whether MATLAB displays the image using `colormap` colors or as an RGB image. If the `CData` array is two-dimensional, then the image is either an indexed image or an intensity image, and in either case the image is displayed using `colormap` colors. If, on the other hand, the `CData` array is m -by- n -by-3, then MATLAB displays it as a truecolor image, ignoring the `colormap` colors.

Image CDataMapping

The `CDataMapping` property controls whether an image is indexed or intensity. An indexed image is displayed by setting the `CDataMapping` property to `'direct'`, in which case the values of the `CData` array are used directly as indices into the figure's `colormap`. When the `image` command is used with a single input argument, it sets the value of `CDataMapping` to `'direct'`.

```
h = image(X); colormap(map)
get(h, 'CDataMapping')
ans =

direct
```

Intensity images are displayed by setting the `CDataMapping` property to `'scaled'`. In this case the `CData` values are linearly scaled to form `colormap`

indices. The scale factors are controlled by the axes `CLim` property. The `imagesc` function creates an image object whose `CDataMapping` property is set to 'scaled', and it also adjusts the `CLim` property of the parent axes. For example,

```
h = imagesc(I,[0 1]); colormap(map)
get(h,'CDataMapping')
ans =

scaled

get(gca,'CLim')
ans =

[0 1]
```

XData and YData

The `XData` and `YData` properties control the coordinate system of the image. For an m -by- n image, the default `XData` is `[1 n]` and the default `YData` is `[1 m]`. These settings imply the following:

- The left column of the image has an x -coordinate of 1.
- The right column of the image has an x -coordinate of n .
- The top row of the image has a y -coordinate of 1.
- The bottom row of the image has a y -coordinate of m .

For example, the statements

```
X = [1 2 3 4; 5 6 7 8; 9 10 11 12];
h = image(X); colormap(colorcube(12))
xlabel x; ylabel y
```

produce the following picture.

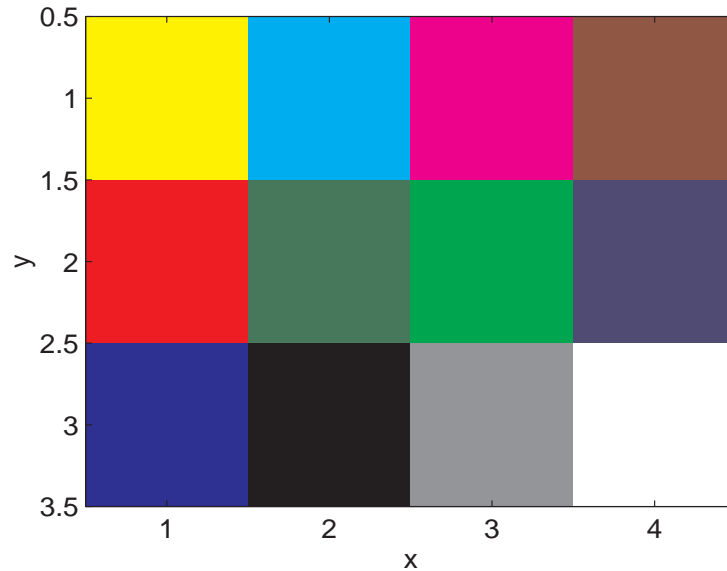

The XData and YData properties of the resulting image object have the default values shown below.

```
get(h,'XData')
ans =
```

```
1 4
```

```
get(h,'YData')
ans =
```

```
1 3
```

However, you can override the default settings to specify your own coordinate system. For example, the statements

```
X = [1 2 3 4; 5 6 7 8; 9 10 11 12];
image(X,'XData',[-1 2],'YData',[2 4]); colormap(colorcube(12))
xlabel x; ylabel y
```

produce the following picture.

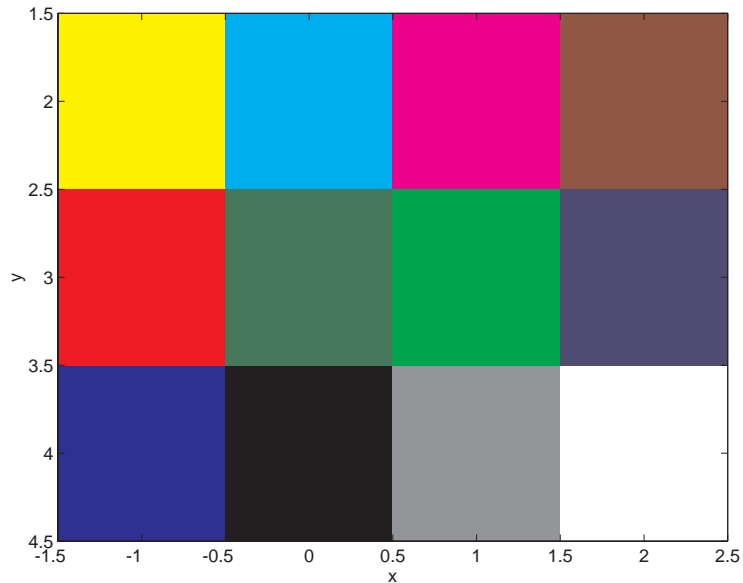

EraseMode

The `EraseMode` property controls how MATLAB updates the image on the screen if the image object's `CData` property changes. The default setting of `EraseMode` is `'normal'`. With this setting, if you change the `CData` of the image object using the `set` command, MATLAB erases the image on the screen before redrawing the image using the new `CData` array. The erase step is a problem if you want to display a series of images quickly and smoothly.

You can achieve fast and visually smooth updates of displayed images as you change the image `CData` by setting the image object `EraseMode` property to `'none'`. With this setting, MATLAB does not take the time to erase the displayed image — it immediately draws the updated image when the `CData` changes.

Suppose, for example, that you have an m -by- n -by-3-by- x array A , containing x different truecolor images of the same size. You can display them dynamically with

```
h = image(A(:,:,:,1), 'EraseMode', 'none');
for i = 2:x
    set(h, 'CData', A(:,:,:,i))
    drawnow
end
```

Rather than creating a new image object each time through the loop, this code simply changes the `CData` of the image object (which was created on the first line using the `image` command). The `drawnow` command causes MATLAB to update the display with each pass through the loop. Because the image `EraseMode` is set to `'none'`, changes to the `CData` do not cause the image on the screen to be erased each time through the loop.

Printing Images

When you set the axes `Position` to `[0 0 1 1]` so that it fills the entire figure, the aspect ratio is not preserved when you print because MATLAB adjusts the figure size when printing according to the figure's `PaperPosition` property. To preserve the image aspect ratio when printing, set the figure's `PaperPositionMode` to `'auto'` from the command line.

```
set(gcf, 'PaperPositionMode', 'auto')  
print
```

When `PaperPositionMode` is set to `'auto'`, the width and height of the printed figure are determined by the figure's dimensions on the screen, and the figure position is adjusted to center the figure on the page. If you want the default value of `PaperPositionMode` to be `'auto'`, enter this line in your `startup.m` file.

```
set(0, 'DefaultFigurePaperPositionMode', 'auto')
```

Converting the Data or Graphic Type of Images

Converting between data types changes the way MATLAB interprets the image data. If you want the resulting array to be interpreted properly as image data, you need to rescale or offset the data when you convert it. (See the earlier sections “Image Types” on page 6-6 and “8-Bit and 16-Bit Indexed Images” on page 6-11 for more information about offsets.)

For certain operations, it is helpful to convert an image to a different image type. For example, if you want to filter a color image that is stored as an indexed image, you should first convert it to RGB format. To do this efficiently, use the `ind2rgb` function, which originated in the Image Processing Toolbox. When you apply the filter to the RGB image, MATLAB filters the intensity values in the image, as is appropriate. If you attempt to filter the indexed image, MATLAB simply applies the filter to the indices in the indexed image matrix, and the results may not be meaningful.

You can also perform certain conversions just using MATLAB syntax. For example, if you want to convert a grayscale image to RGB, you can concatenate three copies of the original matrix along the third dimension.

```
RGB = cat(3,I,I,I);
```

The resulting RGB image has identical matrices for the red, green, and blue planes, so the image is displayed as shades of gray.

Sometimes you will want to change the graphics format of an image, perhaps for compatibility with another software product. This process is very straightforward. For example, to convert an image from a BMP to a PNG, load the BMP using `imread`, set the data type to `uint8`, `uint16`, or `double`, and then save the image using `imwrite`, with 'PNG' specified as your target format. See `imread` and `imwrite` for the specifics of which bit depths are supported for the different graphics formats, and for how to specify the format type when writing an image to file.

Printing and Exporting

Overview of Printing and Exporting (p. 7-2)	Introduction to basic operations, interfaces, parameters, and defaults associated with printing and exporting
How to Print or Export (p. 7-9)	Step-by-step instructions for printing a figure to a printer or to a file, and for exporting a figure to a graphics-format file or to the clipboard
Examples of Basic Operations (p. 7-30)	Examples that provide you with the information you need to submit a simple print or export job
Changing a Figure's Settings (p. 7-38)	How to change the default settings for parameters, such as figure size, paper orientation, background color, and rendering method
Choosing a Graphics Format (p. 7-64)	Factors to consider when choosing a graphics format for exporting to a file, and information about commonly used formats
Choosing a Printer Driver (p. 7-75)	Factors to consider when using a nondefault print driver, and information specific to drivers supported by MATLAB
Troubleshooting (p. 7-85)	Solutions to frequently asked questions and common problems encountered while printing or exporting graphics

Overview of Printing and Exporting

This section is an introduction to the graphics printing capabilities provided with MATLAB and how to make use of them. It covers

- “Print and Export Operations”
- “Graphical User Interfaces”
- “Command Line Interface” on page 7-3
- “Specifying Parameters and Options” on page 7-5
- “Default Settings and How to Change Them” on page 7-6

Print and Export Operations

There are four basic operations that you can perform in printing or transferring figures you’ve created in MATLAB.

Operation	Description
Print	Send a figure from the screen directly to the printer.
Print to File	Write a figure to a PostScript file to be printed later.
Export to File	Export a figure in graphics format to a file, so that you can import it into an application.
Export to Clipboard	Copy a figure to the Windows clipboard, so that you can paste it into an application.

Graphical User Interfaces

You interact with the MATLAB print and export tools using either Microsoft Windows or UNIX graphical user interfaces or with MATLAB commands. The table below lists the dialog boxes you need to print and export and summarizes how to open them from the figure window.

Dialog Box	How to Open	Description
Print (Windows and UNIX)	File->Print or <code>printdlg</code> function	Send figure to the printer, select the printer, print to file, and several other options
Printing Options	Click Options on UNIX Print dialog	Set some of the most commonly used print settings (UNIX only)
Page Setup	File->Page Setup or <code>pagesetupdlg</code> function	Set properties to be associated with the figure when printed or exported
Print Preview	File->Print Preview or <code>printpreview</code> function	View and adjust the final output
Export	File->Export	Export the figure in graphics format to a file
Copy Options	Edit->Copy Options	Set format, figure size, and background color for Copy to Clipboard
Figure Copy Template	File->Preferences	Change text, line, axes, and UI control properties

You can open the **Print**, **Page Setup**, and **Print Preview** dialog boxes from a program or from the command line with the `printdlg`, `pagesetupdlg`, and `printpreview` functions.

Command Line Interface

You can print a MATLAB figure from the command line or from a program. Use the `set` function to set the properties that control how the printed figure looks. Use the `print` function to start the print or export operation.

Modifying Properties with set

The set function changes the values of properties that control the look of a figure. These properties are stored with the figure. When you change one of the properties, the new value is saved with the figure and affects the look of the figure each time you print it until you change the setting again.

To change the print properties of the current figure, the set command has the form

```
set(gcf, 'Property1', value1, 'Property2', value2, ...)
```

where gcf is a call that returns the handle of the current figure, and each property-value pair consists of a named property followed by the value to which the property is set.

For example,

```
set(gcf, 'PaperUnits', 'centimeters', 'PaperType', 'A4', ...)
```

sets the units of measure and the paper size. “Changing a Figure’s Settings” on page 7-38 describes commonly used print properties. The Figure Properties reference page contains a complete list of the properties.

Examining Properties with get

You can also use the get function to retrieve the value of a specific property.

```
a = get(gcf, 'Property')
```

Printing and Exporting with print

The print function performs any of the four actions shown in the table below. You control what action is taken, depending on the presence or absence of certain arguments.

Action	Print Command
Print a figure to a printer	print
Print a figure to a file for later printing	print <i>filename</i>

Action	Print Command
Copy a figure in graphics format to the clipboard	<code>print -dfileformat</code>
Export a figure to a graphics format file that you can later import into an application	<code>print -dfileformat filename</code>

You can also include optional arguments with the `print` command. For example, to export Figure No. 2 to file `spline2d.eps`, with 600 dpi resolution, and using the EPS color graphics format, use

```
print -f2 -r600 -depsc spline2d
```

The functional form of this command is

```
print('-f2', '-r600', '-depsc', 'spline2d');
```

Specifying Parameters and Options

The table below lists parameters you can modify for the figure to be printed or exported. To change one of these parameters, use the **Page Setup** or **Printing Options** (UNIX only) dialog boxes, or use the `set` or `print` function.

See “Changing a Figure’s Settings” on page 7-38 for more detailed instructions.

Parameter	Description
Figure size	Set the size of the figure on the printed page
Figure position	Set the position of the figure on the printed page
Paper size	Select printer paper, specified by dimension or type
Paper orientation	Specify the way the figure is oriented on the page
Position mode	Specify the figure position yourself or have MATLAB determine position automatically
Graphics format	Select the format for exported data (e.g., EPS, JPEG)
Resolution	Specify how finely your figure is to be sampled

Parameter	Description
Renderer	Select the software that processes your graphics data
Renderer mode	Specify the renderer yourself or have MATLAB determine which renderer to use automatically
Axes tick marks	Keep axes tick marks and limits as shown or have MATLAB adjust depending on figure size
Background color	Keep background color as shown on the screen or force it to white
Line and text color	Keep line and text objects as shown on screen or print them in black and white
UI controls	Show or hide all user interface controls in the figure
Bounding box	Leave space between outermost objects in the plot and the edges of its background area
CMYK	Automatically convert RGB values to CMYK values
Character set encoding	Select character set for PostScript printers

Default Settings and How to Change Them

If you have not changed the default print and export settings, MATLAB prints or exports the figure

- 8-by-6 inches with no window frame
- Centered on portrait format 8.5-by-11 inch paper if available
- Using white for the figure and axes background color
- With the ticks and limits of the axes scaled to accommodate the printed size

Setting Defaults for a Figure

In general, to change the property settings for a specific figure, follow the instructions given in the section “Changing a Figure’s Settings” on page 7-38.

Any settings you change with the **Page Setup**, **Print**, and **Printing Options** dialog boxes or with the `set` function are saved with the figure and affect each printing of the figure until you change the settings again.

The settings you change with the **Figure Copy Template Preferences** and **Copy Options Preferences** panels alter the figure as it is displayed on the screen.

Setting Defaults for the Session

MATLAB enables you to set the session defaults for figure properties. Set the session default for a property using the syntax

```
set(0, 'DefaultFigurepropertyname', 'value')
```

where *propertyname* is one of the named figure properties. This example sets the paper orientation for all subsequent print operations in the current MATLAB session.

```
set(0, 'DefaultFigurePaperOrientation', 'landscape')
```

The Figure Properties reference page contains a complete list of the properties.

Setting Defaults Across Sessions

MATLAB enables you to set the session-to-session defaults for figure properties, the print driver, and the print function.

Print Device and Print Command. Set the default print driver and the default print command in your `printopt.m` file. This file contains instructions for changing these settings and for displaying the current defaults. Open `printopt.m` in your editor by typing the command

```
edit printopt
```

Scroll down about 40 lines until you come to this comment line and make your changes after this line.

```
%---> Put your own changes to the defaults here (if needed)
```

For example, to change the default driver, first find the line that sets `dev`, and then replace the text string with an appropriate value. So, to set the default driver to HP LaserJet III, modify the line to read

```
dev = '-dljet3';
```

For the full list of values for `dev`, see the “Drivers” section of the print reference page.

Note If you set `dev` to be a graphics format, such as `-djpeg`, MATLAB exports the figure rather than printing it.

Figure Properties. Set the session-to-session default for a property by including this command in your `startup.m` file:

```
set(0, 'DefaultFigurepropertyname', 'value')
```

where *propertyname* is one of the named figure properties. For example,

```
set(0, 'DefaultFigureInvertHardcopy', 'off')
```

keeps the figure background in the screen color.

This is the same command you use to change a session default, except that it executes automatically every time MATLAB is invoked.

Note Arguments specified with the `print` command override properties set using MATLAB commands or the **Page Setup** dialog box, which in turn override any MATLAB default settings specified in `printopt.m` or `startup.m`.

How to Print or Export

This section covers the following topics to show you the steps you need to take to produce a printed or exported figure:

- “Using Print Preview” on page 7-9
- “Printing a Figure” on page 7-11
- “Printing to a File” on page 7-15
- “Exporting to a File” on page 7-17
- “Exporting to the Windows Clipboard” on page 7-27

Using Print Preview

Before you print or export a figure, preview the image by selecting **Print Preview** from the figure window’s **File** menu. If necessary, you can then click **Page Setup** or use the set function to adjust the look of the printed or exported figure. See “Changing a Figure’s Settings” on page 7-38 for details.

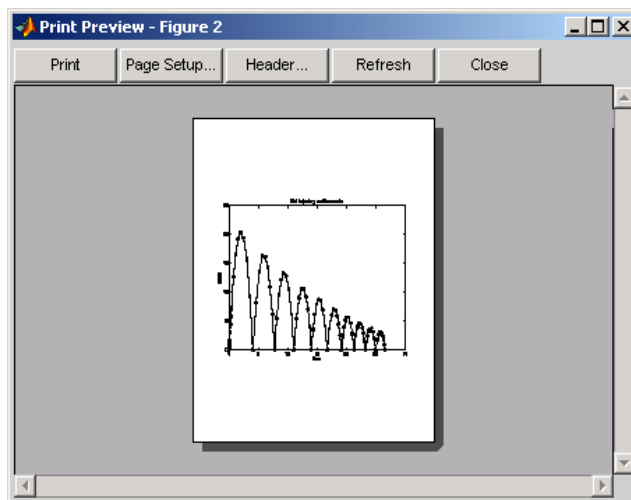

Adding a Header to the Printed Page

You can add a header to the page you are about to print by clicking the **Header** button at the top of the **Print Preview** dialog box. This opens the **Figure Page Header** dialog box, as shown here.

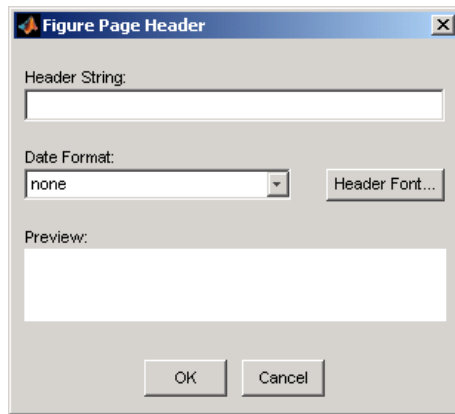

The print header includes any text you want to appear at the top of the printed page. It can also include the current date. Under **Header String**, enter the text of the header. Under **Date Format**, select from a number of possible formats with which to display the current date and/or time. Click **Header Font** to change the font, font style, font size, or script type for the header text and date format.

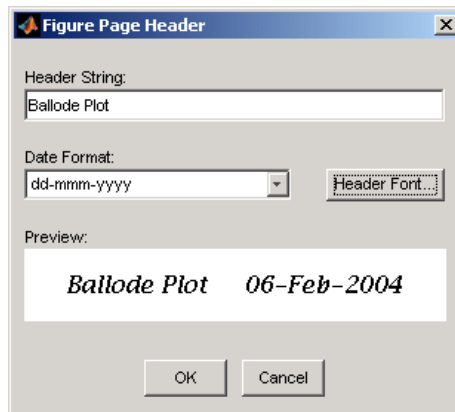

Click **OK** to close the dialog box and apply these settings to your figure.

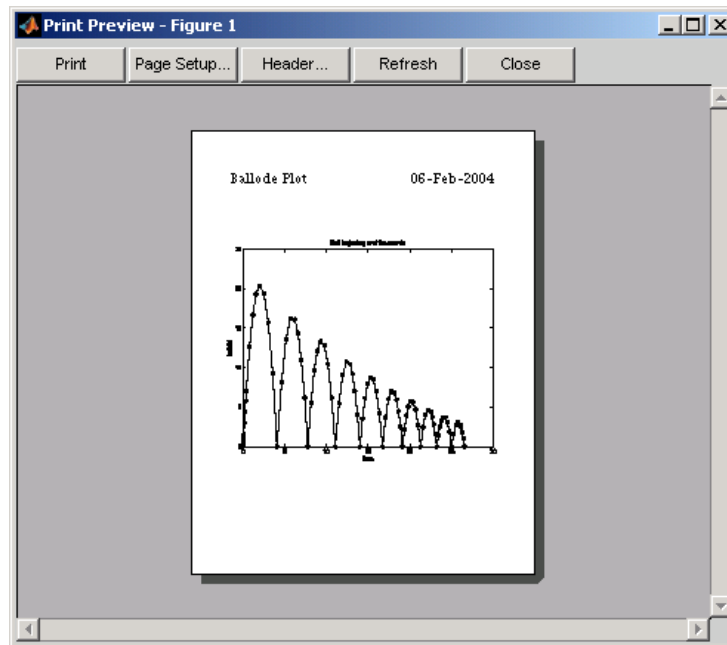

Printing a Figure

This section tells you how to print your figure to a printer:

- “Using the Graphical User Interface on Windows” on page 7-12
- “Using the Graphical User Interface on UNIX” on page 7-13
- “Using MATLAB Commands” on page 7-15

Using the Graphical User Interface on Windows

MATLAB for Windows uses the standard Windows **Print** dialog box, which normally comes with Windows software products. To open the Windows **Print** dialog box, select **Print** from the figure window's **File** menu.

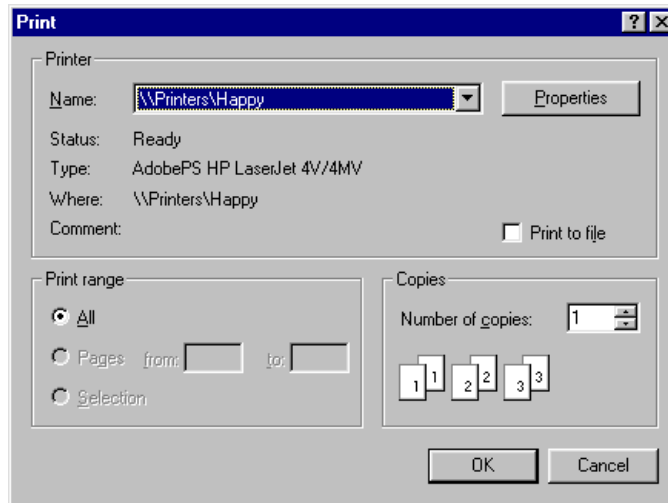

- To print a figure, first select a printer from the list box, then click **OK**.
- To save it to a file, click the **Print to file** check box, click **OK**, and when the **Print to File** window appears, enter the filename you want to save the figure to. MATLAB creates the file in your current working directory.

Settings you can change in the Windows **Print** dialog box are as follows:

Properties. To make changes to settings specific to a printer, click the **Properties** button. This opens the Windows **Document Properties** window.

Print range. You can only select **All** in this panel. The selection does not affect your printed output.

Copies. Enter the number of copies you want to print.

Using the Graphical User Interface on UNIX

MATLAB for UNIX has a **Print** dialog box and an associated **Printing Options** dialog box. To open the **Print** dialog box, select **Print** from the figure window's **File** menu.

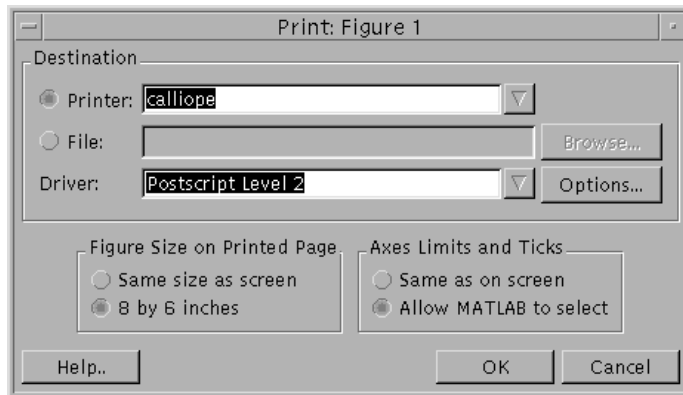

- To print a figure, click the **Printer** button and select a printer from the list box. You can select a driver from the **Driver** list box if you don't want the default driver.
- To save it to a file, click the **File** button, enter a filename, and browse for the directory you want the file saved in.

Settings you can change in the UNIX **Print** dialog box are as follows:

Figure Size on Printed Page. If you want the printed plot to have the same size as it does on your screen, select **Same size as screen**. If you want the printed output to have the default size of 8-by-6 inches, select **8 by 6 inches**.

See “Setting the Figure Size and Position” on page 7-41 for more information.

Axes Limits and Ticks. To force MATLAB to print the same number of ticks and the same limit values for the axes as are used on the screen, select **Same as on screen**. To let MATLAB scale the limits and ticks of the axes based on the size of the printed figure, select **Allow MATLAB to select**.

See “Setting the Axes Ticks and Limits” on page 7-54 for more information.

UNIX Printing Options Dialog Box

To open the **UNIX Printing Options** dialog box, click the **Options** button on the **UNIX Print** dialog box (see figure shown above).

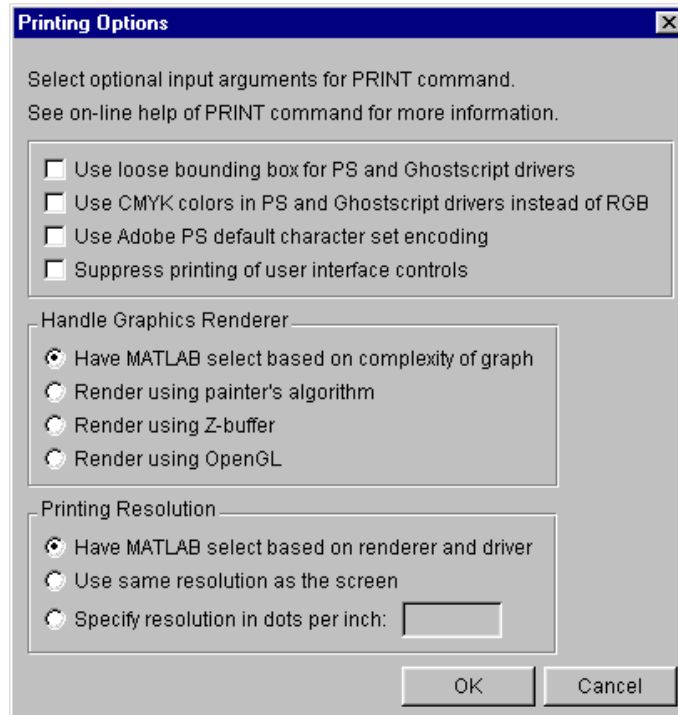

Settings you can change in the **Printing Options** dialog box are as follows:

Use loose bounding box for PS and Ghostscript drivers. Select this box to leave a little space between the outermost objects in the plot and the edges of the plot's background.

Use CMYK colors in PS and Ghostscript drivers instead of RGB. Select this box to produce output in CMYK (cyan, magenta, yellow, black) color space instead of RGB (red, green blue). This is for PostScript printers and drivers only.

Use Adobe PS default character set encoding. Select this box to have MATLAB use the default character set that is supported by all PostScript printers. This option is provided because some early PostScript printers do not support the

PostScript operator `ISOLatin1Encoding`, which MATLAB uses when it generates PostScript files. If your printer does not support this operator, you may notice problems in the text of MATLAB printouts.

Suppress printing of user interface controls. Select this box to prevent any user interface controls that you added to the plot from appearing in the printed plot.

Handle Graphics Renderer. Select one of the radio buttons to have MATLAB select the renderer, or to select a specific renderer from those that MATLAB supports. See “The Default Renderer for MATLAB” on page 7-50 for information on how MATLAB selects a renderer.

Printing Resolution. Select one of the radio buttons to either have MATLAB select the resolution for your printout, to set the resolution to that used for the screen display, or to enter a specific resolution value. See “Default Resolution and When You Can Change It” on page 7-52 for information on how MATLAB selects a resolution setting.

Using MATLAB Commands

Use the `print` function to print from the MATLAB command line or from a program. See “Printing and Exporting with `print`” on page 7-4 for more information.

To send the current or most recently active figure to a printer, simply type

```
print
```

The Printing Options table on the `print` reference page shows a full list of options that you can use with the `print` function. For example, the following command prints Figure No. 2 with 600 dpi resolution, using the Canon BubbleJet BJ200 printer driver:

```
print -f2 -r600 -dbj200
```

Printing to a File

Instead of sending your figure to the printer right now, you have the option of “printing” it to a file, and then sending the file to the printer later on. You can also append additional figures to the same file using the `print` command.

This section tells you how to save your figure to a file

- “Using the Graphical User Interface on Windows”
- “Using the Graphical User Interface on UNIX”
- “Using MATLAB Commands”

Using the Graphical User Interface on Windows

- 1** To open the **Print** dialog box, select **Print** from the figure window’s **File** menu.
- 2** Select the check box labeled **Print to file**, and click the **OK** button.
- 3** The **Print to File** dialog box appears, allowing you to specify the output directory and filename.

Using the Graphical User Interface on UNIX

- 1** To open the **Print** dialog box, select **Print** from the figure window’s **File** menu.
- 2** Select the radio button labeled **File**, and either fill in or browse for the directory and filename.

Using MATLAB Commands

To print the figure to a PostScript file, type

```
print filename
```

If you don’t specify the filename extension, MATLAB uses an extension that is appropriate for the print driver being used.

You can also include an `-options` argument when printing to a file. For example, to append the current figure to an existing file, type

```
print -append filename
```

The only way to append to a file is by using the `print` function. There is no dialog box that enables you to do this.

Note If you print a figure to a file, the file can only be printed and cannot be imported into another application. If you want to create a figure file that you can import into an application, see the next section, “Exporting to a File.”

Appending Additional Figures to a File. Once you have printed one figure to a PostScript file, you can append other figures to that same file using the `-append` option of the `print` function. You can only append using the `print` function.

This example prints Figure No. 2 to PostScript file `myfile.ps`, and then appends Figure No. 3 to the end of the same file.

```
print -f2 myfile
print -f3 -append myfile
```

Exporting to a File

Export a figure in a graphics format to a file if you want to import it into another application, such as a word processor. You can export to a file from the Windows or UNIX **Export Setup** dialog box or from the command line.

This section tells you how to export your figure to a file:

- “Exporting Using the Graphical User Interface” on page 7-18
- “Exporting Using MATLAB Commands” on page 7-23

It also covers

- “Exporting with `getframe`” on page 7-24
- “Saving Multiple Figures to an AVI File” on page 7-25
- “Importing MATLAB Graphics into Other Applications” on page 7-25

For further information, see “Choosing a Graphics Format” on page 7-64.

Exporting Using the Graphical User Interface

Select **Export Setup** from the **File** menu of the figure window. This displays the first of four dialog boxes that enable you to adjust the size, rendering, font, and line appearance of your figure prior to exporting it. You select each of these dialog boxes by clicking the **Size**, **Rendering**, **Fonts**, or **Lines** keyword shown to the left under **Properties**. For a description of each dialog box, see

- “Adjusting the Figure Size” on page 7-18
- “Changing the Rendering” on page 7-19
- “Changing Font Characteristics” on page 7-20
- “Changing Line Characteristics” on page 7-21

Adjusting the Figure Size

Click **Size** in the **Export Setup** dialog box to display this dialog box.

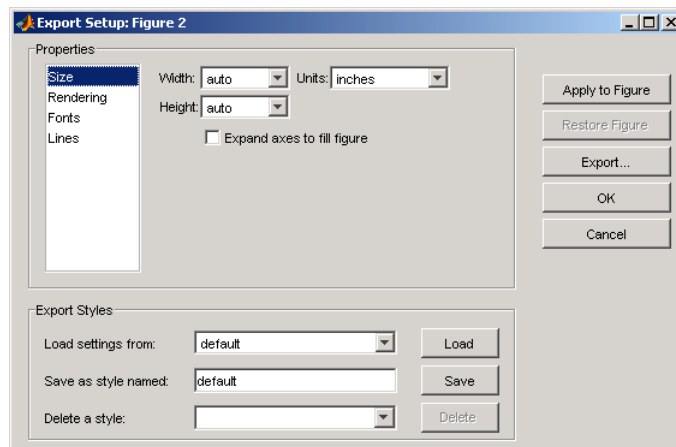

The **Size** dialog box, shown above, modifies the size of the figure as it will appear when imported from the export file into your application. If you leave the **Width** and **Height** settings on auto, the figure remains the same size as it appears on your screen. You can change the size of the figure by entering new values in the **Width** and **Height** text boxes and then clicking **Apply to Figure**. To go back to the original settings, click **Restore Figure**.

To save any settings that you change, or to load settings that you used earlier, see “Saving and Loading Settings” on page 7-22.

Changing the Rendering

Click **Rendering** in the **Export Setup** dialog box to display this dialog box.

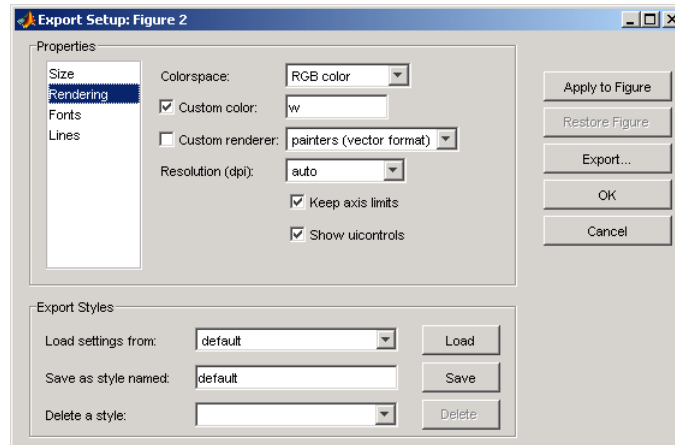

You can change the settings in this dialog box as follows:

Colorspace. Use the drop-down list to select a colorspace. Your choices are

- Black and white
- Grayscale
- RGB color
- CMYK color

Custom Color. Click the check box and enter a color to be used for the figure background. Valid entries are

- white, yellow, magenta, red, cyan, green, blue, or black
- Abbreviated name for the same colors — w, y, m, r, c, g, b, k
- Three-element RGB value — See the help for `colormap` for valid values. Examples: [1 0 1] is magenta. [0 .5 .4] is a dark shade of green.

Custom Renderer. Click the check box and select a renderer from the drop-down list:

- Painter's — Vector format
- OpenGL — Bitmap format
- Z-buffer — Bitmap format

Resolution. You can select one of the following from the drop-down list:

- Screen — The same resolution as used on your screen display
- A specific numeric setting — 150, 300, or 600 dpi
- Auto — MATLAB selects a suitable setting

Keep axis limits. Click the check box to keep axis tick marks and limits as shown. If unchecked, have MATLAB adjust depending on figure size.

Show uicontrols. Click the check box to show all user interface controls in the figure. If unchecked, hide user interface controls.

Changing Font Characteristics

Click **Fonts** in the **Export Setup** dialog box to display this dialog box.

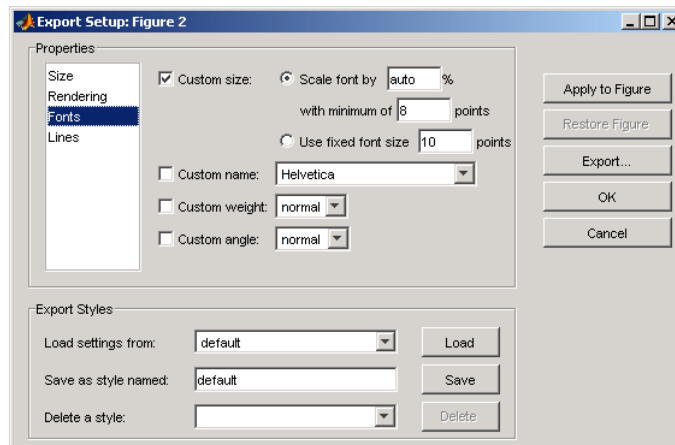

You can change the settings in this dialog box as follows:

Custom Size. Click the check box and use the radio buttons to select a relative or absolute font size for text in the figure.

- **Scale font by N %** — Increases or decreases the size of all fonts by a relative amount, N percent. Enter the word auto to have MATLAB select the appropriate font size.
- **With minimum of N points** — You can specify a minimum font size when scaling the font by a percentage.
- **Use fixed font size N points** — Sets the size of all fonts to an absolute value, N points.

Custom Name. Click the check box and use the drop-down list to select a font name from those offered in the drop-down list.

Custom Weight. Click the check box and use the drop-down list to select the weight or thickness to be applied to text in the figure. Choose from normal, light, demi, or bold.

Custom Angle. Click the check box and use the drop-down list to select the angle to be applied to text in the figure. Choose from normal, italic, or oblique.

Changing Line Characteristics

Click **Lines** in the **Export Setup** dialog box to display this dialog box.

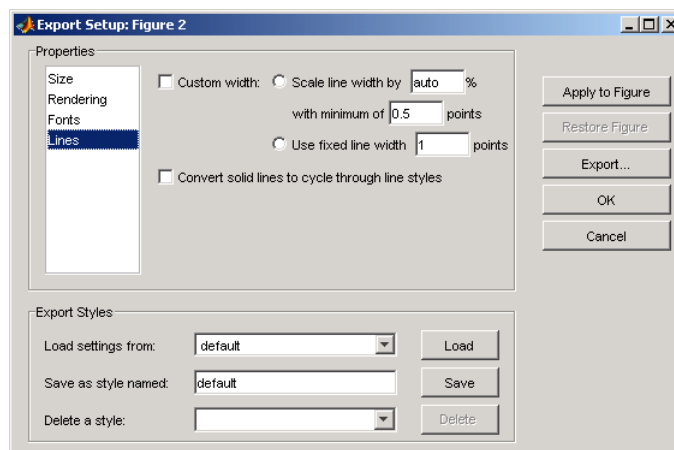

You can change the settings in this dialog box as follows:

Custom width. Click the check box and use the radio buttons to select a relative or absolute line size for the figure.

- **Scale line width by N %** — Increases or decreases the width of all lines by a relative amount, N percent. Enter the word auto to have MATLAB select the appropriate line width.
- **With minimum of N points** — You can specify a minimum line width when scaling the font by a percentage.
- **Use fixed line width N points** — Sets the width of all lines to an absolute value, N points.

Convert solid lines to cycle through line styles. When colored graphics are imported into an application that does not support color, lines that could formerly be distinguished by unique color are likely to appear the same. For example, a red line that shows an input level and a blue line showing output both appear as black when imported into an application that does not support colored graphics.

Clicking this check box causes MATLAB to export lines using different line styles, such as solid, dotted, or dashed lines rather than differentiating between lines based on color.

Saving and Loading Settings

If you think you might use these export settings again at another time, you can save them now and then reload them later. At the bottom of each **Export Setup** dialog box, there is a panel labeled **Export Styles**. To save your current export styles, type a name into the **Save as style named** text box, and then click **Save**.

If you then click the **Load settings from** drop-down list, you will see the name of the style you just saved among the choices of export styles you can load. To load a style, select one of the choices from this list and then click **Load**.

To delete any style you no longer have use for, select that style name from the **Delete a style** drop-down list and click **Delete**.

Exporting the Figure

When you finish setting the export style for your figure, you can export the figure to a file by clicking the **Export** button on the right side of any of the four **Export Setup** dialog boxes. As new window labeled **Save As** opens.

Select a directory to save the file in from the **Save in** list at the top. Select a file type for your file from the **Save as type** drop-down list at the bottom, and then enter a file name in the **File name** text box. Click the **Save** button to export the file.

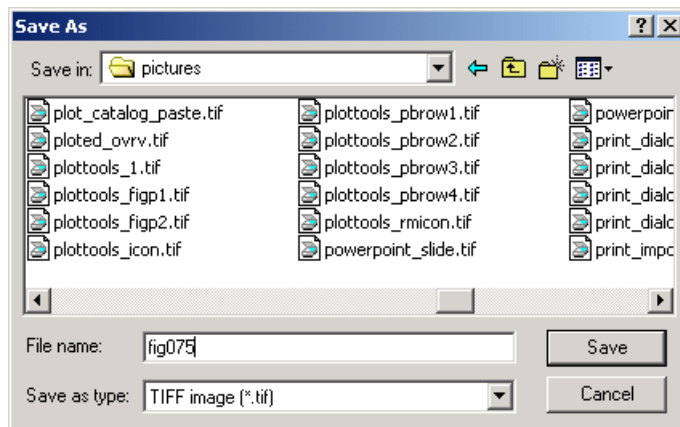

For information on the graphics file formats supported by MATLAB, see “Choosing a Graphics Format” on page 7-64.

Exporting Using MATLAB Commands

Use the `print` function to print from the MATLAB command line or from a program. See “Printing and Exporting with `print`” on page 7-4 for basic information on printing from the command line.

To export the current or most recently active figure, type

```
print -dfileformat filename
```

where `fileformat` is a graphics format supported by MATLAB and `filename` is the name you want to give to the export file. MATLAB selects the filename extension, if you don’t specify it.

You can also specify a number of options with the `print` function. These are shown in the Printing Options table on the print reference page.

For example, to export Figure No. 2 to file `spline2d.eps`, with 600 dpi resolution, and using the EPS color graphics format, type

```
print -f2 -r600 -depsc spline2d
```

Graphics file formats are explained in more detail in the sections “Choosing a Graphics Format” on page 7-64 and “Description of Selected Graphics Formats” on page 7-70.

Exporting with `getframe`

You can use the `getframe` function with `imwrite` to export a graphic. `getframe` is often used in a loop to get a series of frames (figures) with the intention of creating a movie.

Some of the benefits of using this export method over using `print` are

- You can use `getframe` to capture a portion of the figure, rather than the whole figure.
- `imwrite` offers greater flexibility for setting format-specific options, such as the bit depth and compression.

The drawbacks of using this method are that `imwrite` uses built-in MATLAB formats only. Therefore, you do not have access to the Ghostscript formats available to you when exporting with the `print` function or **Export** menu. Also, this technique is limited to screen resolution.

How to Use `getframe` and `imwrite`. Use `getframe` to capture a figure and `imwrite` to save it to a file. `getframe` returns a structure containing the fields `cdata` and `colormap`. The `colormap` field is empty on True Color displays. The following example captures the current figure and exports it to a PNG file.

```
I = getframe(gcf);  
imwrite(I.cdata, 'myplot.png');
```

You should use the proper syntax of `imwrite` for the type of image captured. In the example above, the image is captured from a True Color display. Because the `colormap` field is empty, it is not passed to `imwrite`.

Example — Exporting a Figure Using `getframe` and `imwrite`. This example offers device independence — it will work for either RGB-mode or indexed-mode monitors.

```
X=getframe(gcf);  
if isempty(X.colormap)  
    imwrite(X.cdata, 'myplot.bmp')  
else  
    imwrite(X.cdata, X.colormap, 'myplot.tif')  
end
```

For information about available file formats and format-specific options, see the `imwrite` reference page. For information about creating a movie from a series of frames, see the reference pages for `getframe` and `movie`, or see “Movies” in Chapter 5, “Creating Specialized Plots”.

Saving Multiple Figures to an AVI File

You can also save multiple figures to an AVI file using the MATLAB `avifile` and `addframe` functions. AVI files can be used for animated sequences and do not need MATLAB to run, but do require an AVI viewer. For more information, see “Exporting Audio/Video Data” in the MATLAB Programming documentation.

Importing MATLAB Graphics into Other Applications

You can include MATLAB graphics in a wide variety of applications for word processing, slide preparation, modification by a graphics program, presentation on the Internet, and so on. In general, the process is the same for all applications:

- 1** Use MATLAB to create the figure you want to import into another application.
- 2** Export the MATLAB figure to one of the supported graphics file formats, selecting a format that is both appropriate for the type of figure and supported by the target application. See “Choosing a Graphics Format” on page 7-64 for help.
- 3** Use the import features of the target application to import the graphics file.

Edit Before You Export. Vector graphics may be fully editable in a few high-end applications, but most applications do not support editing beyond simple resizing. Bitmaps cannot be edited with quality results unless you use a software package devoted to image processing. In general, you should try to make all the necessary settings while your figure is still in MATLAB.

Importing into Microsoft Applications. To import your exported figure into a Microsoft application, select **Picture** from the **Insert** menu. Then select **From File** and navigate to your exported file. If you use the clipboard to perform your export operations, you can take advantage of the recommended MATLAB settings for Word and PowerPoint.

Example — Importing an EPS Graphic into LaTeX. This example shows how to import an EPS file named `peaks.eps` into LaTeX.

```
\documentclass{article}

\usepackage{graphicx}

\begin{document}

\begin{figure}[h]
\centerline{\includegraphics[height=10cm]{peaks.eps}}
\caption{Surface Plot of Peaks}
\end{figure}

\end{document}
```

EPS graphics can be edited after being imported to LaTeX. For example, you can specify the height in any LaTeX-compatible dimension. To set the height to 3.5 inches, use the command

```
height=3.5in
```

You can use the `angle` function to rotate the graph. For example, to rotate the graph 90 degrees, add

```
angle=90
```

to the same line of code that sets the height, i.e., `[height=10cm,angle=90]`.

Exporting to the Windows Clipboard

You can export a figure to the Windows clipboard using one of two graphics formats: EMF color vector or BMP 8-bit color bitmap.

By default, MATLAB chooses the graphics format for you, based on the rendering method used to display the figure. For figures rendered with OpenGL or Z-buffer, MATLAB uses the BMP format. For figures rendered with Painter's, the EMF format is used. For information about how MATLAB selects a rendering method, see "The Default Renderer for MATLAB" on page 7-50.

To override the selection by MATLAB, specify the format of your choice using either the Windows **Copy Options Preferences** dialog box, or the `-d` switch in the print command.

You can export to the clipboard:

- "Using the Graphical User Interface on Windows" on page 7-27
- "Using MATLAB Commands" on page 7-29

Using the Graphical User Interface on Windows

Before you export the figure to the clipboard, you can use the **Copy Options Preferences** dialog box to select a nondefault graphics format, or to adjust certain figure settings. These settings become the new defaults for all figures exported to the clipboard.

To open the **Copy Options Preferences** dialog box, select **Copy Options** from the figure window's **Edit** menu. Any changes you make with this dialog box affect only the clipboard copy of the figure; they do not affect the way the figure looks on the screen.

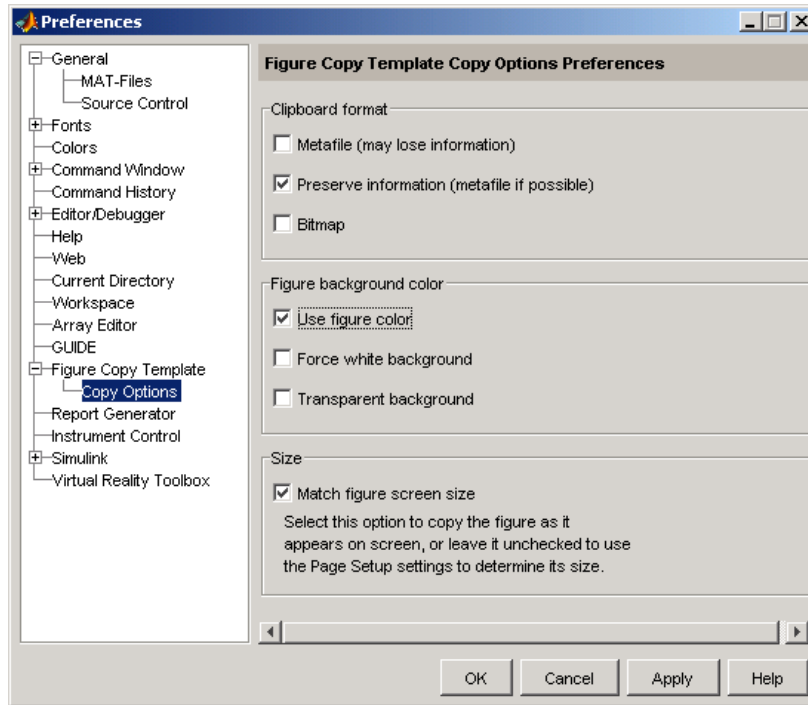

Settings you can change in the **Copy Options Preferences** dialog box are as follows:

Clipboard format. To copy the figure in EMF color vector format, select **Metafile**. To use BMP 8-bit color bitmap format, select **Bitmap**. Or, to have MATLAB select the format for you, select **Preserve information**. MATLAB uses the metafile format whenever possible.

Figure background color. To keep the background color the same as it appears on the screen, select **Use figure color**. To make the background white, select **Force white background**. For a background that is transparent, for example, a slide background to frame the axes part of a figure, select **Transparent background**.

Size. Select **Match figure screen size** to copy the figure as it appears on the screen, or leave it unselected to use the **Page Setup** settings to determine its size.

- 1** Open the **Copy Options Preferences** dialog box if you need to make any changes to those preferences used in copying to the clipboard.
- 2** Click **OK** to set the new preferences. These will be used for all future figures exported to the clipboard.
- 3** Select **Copy Figure** from the figure window's **Edit** menu to copy the figure to the clipboard.

Using MATLAB Commands

Export to the clipboard using the `print` function with a graphics format, but no filename. You must use one of the following clipboard formats: `-dbitmap` or `-dmeta`. These switches create a Windows bitmap (BMP) or an enhanced metafile (EMF), respectively.

For example, to export the current figure to the clipboard in enhanced metafile format, type

```
print -dmeta
```

Note When printing, the `print -d` option specifies a printer driver. When exporting, the `print -d` option specifies a graphics format.

Examples of Basic Operations

This section provides step-by-step instructions for common printing and exporting tasks. Each printing example tells you how to perform the task from the print menus and from the command line. You can perform some tasks from the command line and others only from the menus.

The examples presented here are

- “Printing a Figure at Screen Size”
- “Printing with a Specific Paper Size” on page 7-31
- “Printing a Centered Figure” on page 7-32
- “Exporting in a Specific Graphics Format” on page 7-33
- “Exporting in EPS Format with a TIFF Preview” on page 7-34
- “Exporting a Figure to the Clipboard” on page 7-35

Printing a Figure at Screen Size

By default, MATLAB prints your figure at 8-by-6 inches. This size includes the area delimited by the background. This example shows how to print or export your figure the same size it is displayed on your screen.

Using the Graphical User Interface

- 1** Resize your figure window to the size you want it to be when printed.
- 2** Select **Page Setup** from the figure window’s **File** menu, and select the **Size and Position** tab.
- 3** In the **Mode** panel, select **Use screen size, centered on page**.
- 4** Click **OK**.
- 5** Open the **Print** dialog box and print the figure.

Using MATLAB Commands

Set the PaperPositionMode property to auto before printing the figure.

```
set(gcf, 'PaperPositionMode', 'auto');  
print
```

If later you want to print the figure at its original size, set PaperPositionMode back to 'manual'.

Printing with a Specific Paper Size

By default, MATLAB uses 8.5-by-11 inch paper. This example shows how to change the paper size to 8.5-by-14 inches by selecting a paper type (Legal).

Using the Graphical User Interface

- 1 Select **Page Setup** from the figure window's **File** menu, and select the **Paper** tab.
- 2 Select the **Legal** paper type from the list under **Paper size**. The width and height fields update to 8.5 and 14, respectively.
- 3 Make sure that **Units** is set to inches.
- 4 Click **OK**.
- 5 Open the **Print** dialog box and print the figure.

Using MATLAB Commands

Set the PaperUnits property to inches, and the PaperType property to Legal.

```
set(gcf, 'PaperUnits', 'inches');  
set(gcf, 'PaperType', 'Legal');
```

Alternatively, you can set the PaperSize property to the size of the paper, in the specified units.

```
set(gcf, 'PaperUnits', 'inches');  
set(gcf, 'PaperSize', [8.5 14]);
```

Printing a Centered Figure

This example sets the size of a figure to 5.5-by-3 inches and centers it on the paper.

Using the Graphical User Interface

- 1 Select **Page Setup** from the figure window's **File** menu, and select the **Size and Position** tab.
- 2 Make sure **Use manual size and position** is selected.
- 3 Enter 5.5 in the **Width** field and 3 in the **Height** field.
- 4 Make sure that **Units** field is set to inches.
- 5 Click **Center**.
- 6 Click **OK**.
- 7 Open the **Print** dialog box and print the figure.

Using MATLAB Commands

- 1 Start by setting PaperUnits to inches.

```
set(gcf, 'PaperUnits', 'inches')
```
- 2 Use PaperSize to return the size of the current paper.

```
papersize = get(gcf, 'PaperSize')
```

```
papersize =  
      8.5000   11.0000
```
- 3 Initialize variables to the desired width and height of the figure.

```
width = 5.5;           % Initialize a variable for width.  
height = 3;           % Initialize a variable for height.
```

- 4 Calculate a left margin that centers the figure horizontally on the paper. Use the first element of `papersize` (width of paper) for the calculation.

```
left = (papersize(1) - width) / 2
```

```
left =  
    1.5000
```

- 5 Calculate a bottom margin that centers the figure vertically on the paper. Use the second element of `papersize` (height of paper) for the calculation.

```
bottom = (papersize(2) - height) / 2
```

```
bottom =  
    4
```

- 6 Set the figure size and print.

```
myfigure_size = [left, bottom, width, height];  
set(gcf, 'PaperPosition', myfigure_size);  
print
```

Exporting in a Specific Graphics Format

Export a figure to a graphics-format file when you want to import it at a later time into another application such as a word processor.

Using the Graphical User Interface

- 1 Select **Export** from the figure window's **File** menu.
- 2 Use the **Save in** field to navigate to the directory in which you want to save your file.
- 3 Select a graphics format from the **Save as type** list.
- 4 Enter a filename in the **File name** field. An appropriate file extension, based on the format you chose, is displayed.
- 5 Click **Save** to export the figure.

Using MATLAB Commands

From the command line, you must specify the graphics format as an option. See the print reference page for a complete list of graphics formats and their corresponding option strings.

This example exports a figure to an EPS color file, `myfigure.eps`, in your current directory.

```
print -depsc myfigure
```

This example exports Figure No. 2 at a resolution of 300dpi to a 24-bit JPEG file, `myfigure.jpg`.

```
print -djpeg -f2 -r300 myfigure
```

This example exports a figure at screen size to a 24-bit TIFF file, `myfigure.tif`.

```
set(gcf, 'PaperPositionMode', 'auto') % Use screen size
print -dtiff myfigure
```

Exporting in EPS Format with a TIFF Preview

Use the `print` function to export a figure in EPS format with a TIFF preview. When you import the figure, the application can display the TIFF preview in the source document. The preview is color if the exported figure is color, and black and white if the exported figure is black and white.

This example exports a figure to an EPS color format file, `myfigure.eps`, and includes a color TIFF preview.

```
print -depsc -tiff myfigure
```

This example exports a figure to an EPS black-and-white format file, `myfigure.eps`, and includes a black-and-white TIFF preview.

```
print -deps -tiff myfigure
```

Exporting a Figure to the Clipboard

Export a figure to the clipboard in graphics format when you want to paste it into another Windows application such as a word processor.

Using the Graphical User Interface on Windows

This example exports a figure to the clipboard in enhanced metafile (EMF) format. Figure settings are chosen that would make the exported figure suitable for use in a PowerPoint slide. Note that changing the settings modifies the figure displayed on the screen.

- 1 Create a figure containing text. You can use the following code.

```
x = -pi:0.01:pi;
h = plot(x, sin(x));
title('Sine Plot');
```

- 2 Select **Preferences** from the figure window's **File** menu. Then select **Figure Copy Template** from the **Preferences** dialog box.
- 3 In the **Figure Copy Template Preferences** panel, click the **PowerPoint** button. The MATLAB suggested settings for PowerPoint are added to the template.

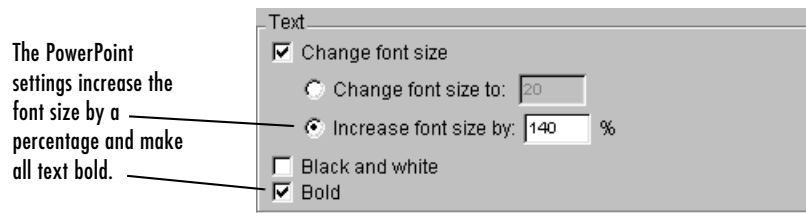

The **Text** panel after the **PowerPoint** button is clicked

- 4 In the **Lines** panel, change the **Custom width** to 4 points.
- 5 In the **Uicontrols and axes** panel, select **Keep axes limits and tick spacing** to prevent MATLAB from possibly rescaling tick marks and limits when you export.

- 6** Click **Apply to Figure**. The changes appear in the figure window.

If you don't like the way your figure looks with the new settings, you can restore it to its original settings by clicking the **Restore Figure** button.
- 7** In the left pane of the **Preferences** dialog box, expand the **Figure Copy Template** topic. Select **Copy Options**.
- 8** In the **Copy Options** panel, select **Metafile** to tell MATLAB to export the figure in EMF format.
- 9** Check that **Transparent background** is selected. This choice makes the figure background transparent and allows the slide background to frame the axes part of the figure.
- 10** Clear the **Match figure screen size** check box so that you can use your own figure size settings.
- 11** Click **OK**.
- 12** Select **Page Setup** from the figure window's **File** menu.
- 13** In the **Size and Position** tab, set **Width** to 10 and **Height** to 7.5. Make sure that **Units** are set to inches.
- 14** Click **OK**.
- 15** Select **Copy Figure** from the **Edit** menu. Your figure is now exported to the clipboard and can be pasted into another Windows application such as a PowerPoint slide.

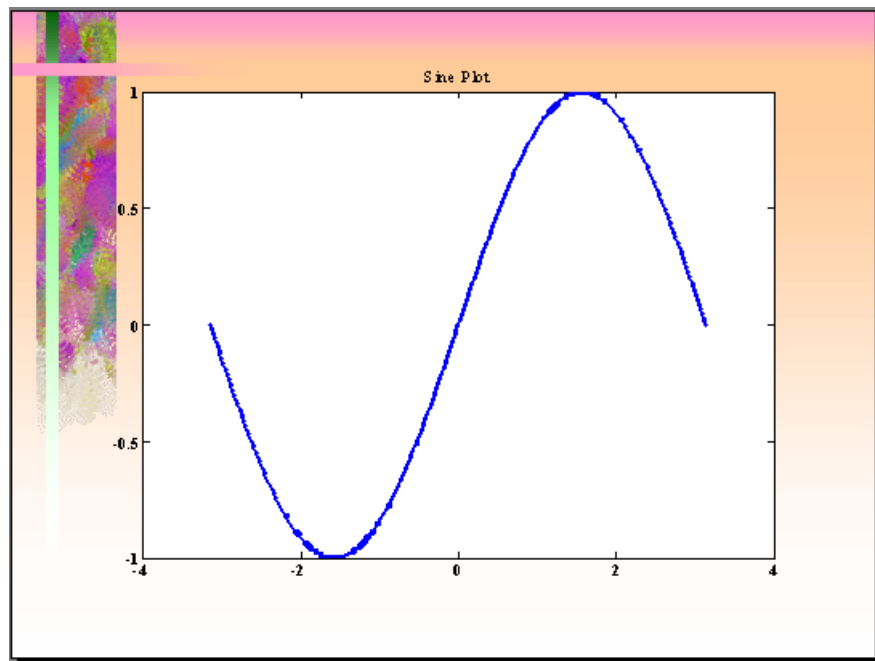

Using MATLAB Commands

Use the `print` function and one of two clipboard formats (`-dmeta`, `-dbitmap`) to export a figure to the clipboard. Do *not* specify a filename.

This example exports a figure to the clipboard in enhanced metafile (EMF) format.

```
print -dmeta
```

This example exports a figure to the clipboard in bitmap (BMP) 8-bit color format.

```
print -dbitmap
```

Changing a Figure's Settings

The table below shows parameters that you can set before submitting your figure to the printer.

Column 1 of the table lists all parameters that you can change.

Column 2 shows the default setting that MATLAB uses.

Column 3 shows which dialog box to use to set that parameter. If you can make this setting on only one platform, this is noted in parentheses: (W) for Windows, and (U) for UNIX.

Some dialog boxes have tabs at the top to enable you to select a certain category. These categories are denoted in the table below using the format <dialogbox>/<tabname>. For example, “**Page Setup/Size ...**” in this column means to use the **Page Setup** dialog box, selecting the **Size and Position** tab.

Column 4 shows how to set the parameter using the MATLAB print or set function. When using print, the table shows the appropriate command option (for example, print -loose). When using set, it shows the property name to set along with the type of object (for example, (Line) for line objects).

Parameter	Default	Dialog Box	PRINT Command or SET Property
Select figure	Last active window	None	print -fhandle
Select printer	System default	Print	print -pprinter
Figure size	8-by-6 inches	Page Setup/Size ...	PaperSize (Figure) PaperUnits (Figure)
Position on page	0.25 in. from left, 2.5 in. from bottom	Page Setup/Size ...	PaperPosition (Figure) PaperUnits (Figure)
Position mode	Manual	Page Setup/Size ...	PaperPositionMode (Figure)
Paper type	Letter	Page Setup/Paper	PaperType (Figure)

Parameter	Default	Dialog Box	PRINT Command or SET Property
Paper orientation	Portrait	Page Setup/Paper	PaperOrientation (Figure)
Renderer	Selected by MATLAB	Page Setup/Axes ...	print -zbuffer -painters -opengl
Renderer mode	Auto	Page Setup/Axes ...	RendererMode (Figure)
Resolution	Depends on driver or graphics format	Print Properties (W) Printing Options (U)	print -resolution
Axes tick marks	Recompute	Page Setup/Axes ...	XTickMode, etc. (Axes)
Background color	Force to white	Page Setup/Axes ...	Color (Figure) InvertHardCopy (Figure)
Font size	As in the figure	Fig. Copy Template	FontSize (Text)
Bold font	Regular font	Fig. Copy Template	FontWeight (Text)
Line width	As in the figure	Fig. Copy Template	LineWidth (Line)
Line style	Black or white	Fig. Copy Template	LineStyle (Line)
Line and text color	Black and white	Page Setup/Lines ...	Color (Line, Text)
CMYK color	RGB color	Printing Options (U)	print -cmyk
UI controls	Printed	Page Setup/Axes ...	print -noui
Bounding box	Tight	Printing Options (U)	print -loose
Copy background	Transparent	Copy Options (W)	See "Background color"
Copy size	Same as screen size	Copy Options (W)	See "Figure Size"

Selecting the Figure

By default, MATLAB prints the current figure. If you have more than one figure open, the current figure is the last one that was active. To make a different figure active, click on it to bring it to the foreground.

Using MATLAB Commands

Specify a figure handle using the command

```
print -figure_handle
```

This example sends Figure No. 2 to the printer. A figure's number is usually its handle.

```
print -f2
```

Selecting the Printer

You can select the printer you want to use with the **Print** dialog box or with the `print` function.

Using the Graphical User Interface

- 1 Select **Print** from the figure window's **File** menu.
- 2 Select the printer from the list box near the top of the **Print** dialog box.
- 3 Click **OK**.

Using MATLAB Commands

You can select the printer using the `-P` switch of the `print` function.

This example prints Figure No. 3 to a printer called Calliope.

```
print -f3 -PCalliope
```

If the printer name has spaces in it, put quotation marks around the `-P` option, as shown here.

```
print "-Pmy local printer"
```

Using a Network Print Server. On Windows NT, Windows 2000, and Windows XP systems, you can print to a network print server using the form shown here for a printer named trinity.

```
print -P\\PRINTERS\trinity
```

Setting the Figure Size and Position

The default output figure size is 8 inches wide by 6 inches high, which maintains the aspect ratio (width to height) of the MATLAB figure window. The figure's default position is centered both horizontally and vertically when printed to a paper size of 8.5-by-11 inches.

You can change the size and position of the figure:

- “Using the Graphical User Interface”
- “Using MATLAB Commands” on page 7-44

Using the Graphical User Interface

Select **Page Setup** from the figure window's **File** menu to open the **Page Setup** dialog box. Click the **Size and Position** tab to make changes to the size and position of your figure on the printed page.

Use the text edit boxes on the left to enter new dimensions for your figure. Or use the graphical user interface at the right to drag the borders and location of the “sample” figure with your mouse.

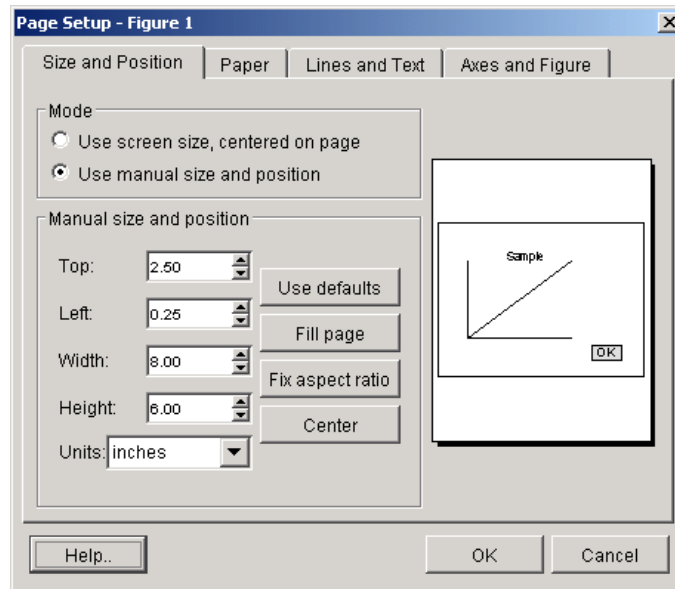

Settings you can change in the **Size and Position** window are as follows:

Mode. Choose whether you want the figure to be the same size as it is displayed on your screen, or you want to manually change its size using the options in the **Size and Position** window.

The next two panels are enabled only when you select the **Use manual size and position** mode.

Manual size and position. Enter the measurements and units for the size and position of the figure.

Graphical User Interface. Use the “Sample” figure at the right of the dialog box to move and resize your MATLAB figure interactively.

To set the width and height interactively, use the mouse to drag the edges of the “Sample” figure to the desired size.

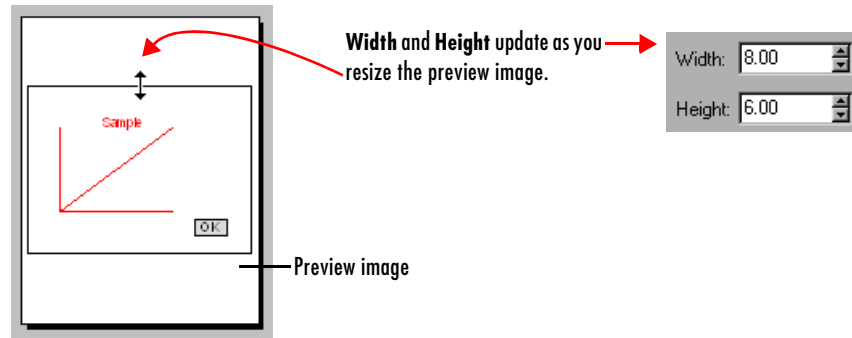

To set the margins of the figure (offsets from the left and top edges of the paper), drag the entire “Sample” figure to a new position with the mouse.

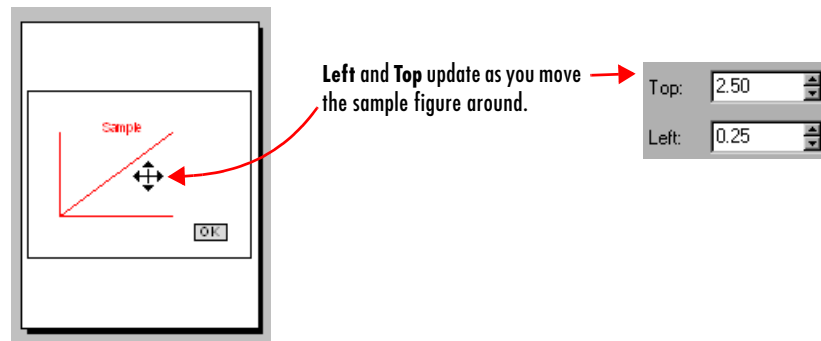

If you want the figure resized to fill the paper, click **Fill page**. Note that **Fill page** might alter the aspect ratio of your image. To get the maximum figure size without altering the aspect ratio, select **Fix aspect ratio**.

Note Changes you make using **Page Setup** affect the printed output only. They do not alter the figure displayed on your screen.

Using MATLAB Commands

To print your figure with a specific size or position, make sure that the `PaperPositionMode` property is set to `manual` (the default). Then set the `PaperPosition` property to the desired size and position.

The `PaperPosition` property references a four-element row vector that specifies the position and dimensions of the printed output. The form of the vector is

```
[left bottom width height]
```

where

- `left` specifies the distance from the left edge of the paper to the left edge of the figure.
- `bottom` specifies the distance from the bottom of the paper to the bottom of the figure.
- `width` and `height` specify the figure's width and height.

The MATLAB default values for `PaperPosition` are

```
[0.25 2.5 8.0 6.0]
```

This example sets the figure size to a width of 4 inches and height of 2 inches, with the origin of the figure positioned 2 inches from the left edge of the paper and 1 inch from the bottom edge.

```
set(gcf, 'PaperPositionMode', 'manual');  
set(gcf, 'PaperUnits', 'inches');  
set(gcf, 'PaperPosition', [2 1 4 2]);
```

Note `PaperPosition` specifies a bottom margin, rather than a top margin as **Page Setup** does. When you set the top margin using **Page Setup**, MATLAB uses this setting to calculate the bottom margin, and updates the `PaperPosition` property appropriately.

Setting the Paper Size or Type

Set the paper size by specifying the dimensions or by choosing from a list of predefined paper types. If you do not set a paper size or type, MATLAB uses the default paper size of 8.5-by-11 inches.

Paper-size and paper-type settings are interrelated — if you set a paper type, MATLAB updates the paper size. For example, if you set the paper type to US Legal, MATLAB updates the width of the paper to 8.5 inches and the height to 14 inches.

You can change the paper size and orientation:

- “Using the Graphical User Interface”
- “Using MATLAB Commands” on page 7-46

Using the Graphical User Interface

Select **Page Setup** from the figure window's **File** menu to open the **Page Setup** dialog box. Click the **Paper** tab to make changes to the paper type and orientation of the figure on the printed page.

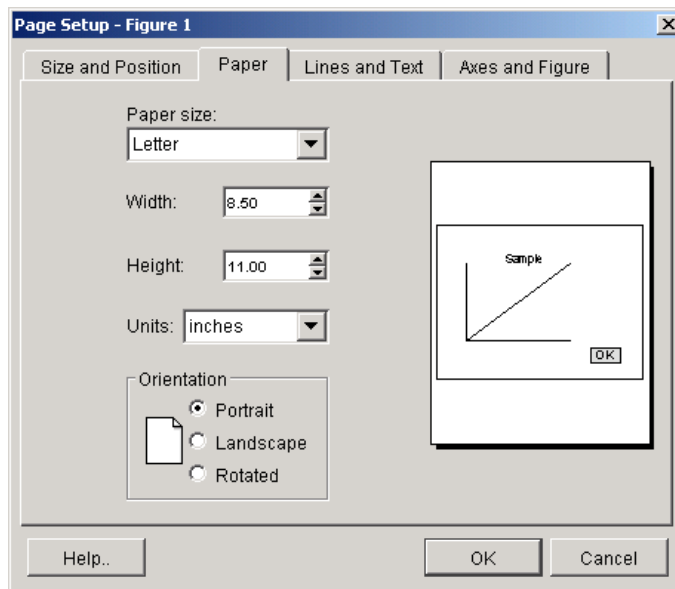

Settings you can change in the **Paper** window are as follows:

Paper size. Select a paper type from the list under **Paper size**. If there is no paper type with suitable dimensions, enter your own dimensions in the **Width** and **Height** fields. Make sure **Units** is set appropriately to inches, centimeters, points, or normalized.

Orientation. Select how you want the figure to be oriented on the printed page. The illustration under “Setting the Paper Orientation” on page 7-46 shows the three types of orientation you can choose from.

Note Changes you make using **Page Setup** affect the printed output only. They do not alter the figure displayed on your screen.

Using MATLAB Commands

Set the `PaperType` property to one of the built-in MATLAB paper types, or set the `PaperSize` property to the dimensions of the paper.

When you select a paper type, the unit of measure is not automatically updated. We recommend that you set the `PaperUnits` property first.

For example, these commands set the units to centimeters and the paper type to A4.

```
set(gcf, 'PaperUnits', 'centimeters');  
set(gcf, 'PaperType', 'A4');
```

This example sets the units to inches and sets the paper size of 5-by-7 inches.

```
set(gcf, 'PaperUnits', 'inches');  
set(gcf, 'PaperSize', [5 7]);
```

If you set a paper size for which there is no matching paper type, the `PaperType` property is automatically set to '`<custom>`'.

Setting the Paper Orientation

Paper orientation refers to how the paper is oriented with respect to the figure. The choices are **Portrait** (the default), **Landscape**, and **Rotated**.

You can change the orientation of the figure:

- “Using the Graphical User Interface”
- “Using MATLAB Commands” on page 7-48

The figure below shows the same figure printed using the three different orientations.

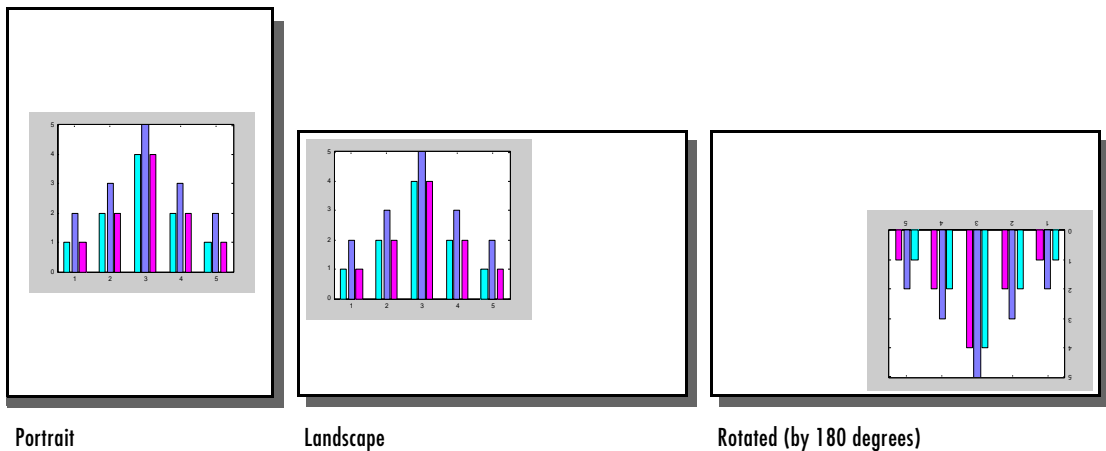

Note The rotated orientation is not supported by all printers. When the printer does not support it, landscape is used.

Using the Graphical User Interface

- 1 Select **Page Setup** from the figure window's **File** menu and select the **Paper** tab. (See “Using the Graphical User Interface” on page 7-45).
- 2 Select the appropriate option button under **Orientation**.
- 3 Click **OK**.

Using MATLAB Commands

Use the `PaperOrientation` figure property or the `orient` function. Use the `orient` function if you always want your figure centered on the paper.

The following example sets the orientation to landscape:

```
set(gcf, 'PaperOrientation', 'landscape');
```

Centering the Figure. If you set the `PaperOrientation` property from portrait to either of the other two orientation schemes, you might find that what was previously a centered image is now positioned near the paper's edge. You can either adjust the position (use the `PaperPosition` property), or you can use the `orient` function, which always centers the figure on the paper.

The `orient` function takes the same argument names as `PaperOrientation`. For example,

```
orient rotated;
```

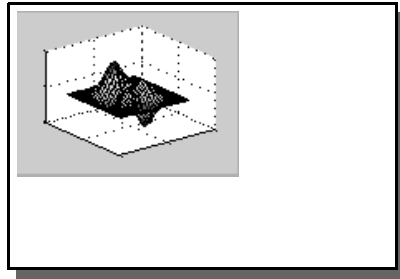

Orientation set to 'landscape' using 'PaperOrientation' property.

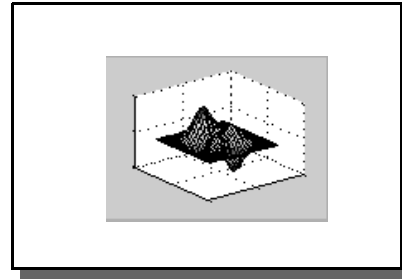

Orientation set to 'landscape' using `orient` function.

Selecting a Renderer

A renderer is software and/or hardware that processes graphics data (such as vertex coordinates) to display, print, or export a figure. You can change the renderer that MATLAB uses when printing a figure:

- “Using the Graphical User Interface” on page 7-51
- “Using MATLAB Commands” on page 7-51

Renderers Supported by MATLAB

MATLAB supports three rendering methods with the following characteristics:

Painter's

- Draws figures using vector graphics
- Generally produces higher resolution results
- The fastest renderer when the figure contains only simple or small graphics objects
- The only renderer possible when printing with the HPGL print driver or exporting to an Adobe Illustrator file
- The best renderer for creating PostScript or EPS files
- Cannot render figures that use RGB color for patch or surface objects
- Does not show lighting or transparency

Z-buffer

- Draws figures using bitmap (raster) graphics
- Faster and more accurate than Painter's
- Can consume a lot of system memory if MATLAB is displaying a complex scene
- Shows lighting, but not transparency

OpenGL

- Draws figures using bitmap (raster) graphics
- Generally faster than Painter's or Z-buffer
- In some cases, enables MATLAB to access graphics hardware that is available on some systems
- Shows both lighting and transparency

For more detailed information about the rendering methods, see [Renderer](#) on the [Figure Properties](#) reference page.

The Default Renderer for MATLAB

By default, MATLAB automatically selects the best rendering method, based on the attributes of the figure (its complexity and the settings of various Handle Graphics properties) and in some cases, the printer driver or file format used.

In general, MATLAB uses

- Painter's for line plots, area plots (bar graphs, histograms, etc.), and simple surface plots
- Z-buffer when the computer screen is not truecolor or when the `opengl` function was called with `selection_mode` set to `neverselect`
- OpenGL for complex surface plots using interpolated shading and any figure using lighting

The `RendererMode` property tells MATLAB whether to automatically select the renderer based on the contents of the figure (when set to `auto`), or to use the `Renderer` property that you have indicated (when set to `manual`).

Reasons for Manually Setting the Renderer

Two reasons to set the renderer yourself are

- To make your printed or exported figure look the same as it did on the screen. The rendering method used for printing and exporting the figure is not always the same method used to display the figure.
- To avoid unintentionally exporting your figure as a bitmap within a vector format. For example, MATLAB typically renders high-complexity plots using OpenGL or Z-buffer. If you export a high-complexity figure to the EPS or EMF vector formats without specifying a rendering method, MATLAB might use OpenGL or Z-buffer, each of which creates bitmap graphics.

Storing a bitmap in a vector file can generate a very large file that takes a long time to print. If you use one of these formats and want to make sure that your figure is saved as a vector file, be sure to set the rendering method to Painter's.

Using the Graphical User Interface

- 1 Open the **Page Setup** dialog box by selecting **Page Setup** from the figure window's **File** menu. Select the **Axes and Figure** tab.
- 2 Under **Figure renderer**, select the desired rendering method from the list box.
- 3 Click **OK**.

Using MATLAB Commands

You can use the `Renderer` property or a switch with the `print` function to set the renderer for printing or exporting. These two lines each set the renderer for the current figure to Z-buffer.

```
set(gcf, 'Renderer', 'zbuffer');
```

or

```
print -zbuffer
```

The first example saves the new value of `Renderer` with the figure; the second example only affects the current print or export operation.

Note that when you set the `Renderer` property, the `RendererMode` property is automatically reset from `auto` (the factory default) to `manual`.

Setting the Resolution

Resolution refers to how accurately your figure is rendered when printed or exported. Higher resolutions produce higher quality output. The specific definition of resolution depends on whether your figure is output as a bitmap or as a vector graphic.

You can change the resolution that MATLAB uses to print a figure:

- “Using the Graphical User Interface on Windows” on page 7-53
- “Using the Graphical User Interface on UNIX” on page 7-54
- “Using MATLAB Commands” on page 7-54

Default Resolution and When You Can Change It

The default resolution depends on the renderer used and the graphics format or printer driver specified. The following two tables summarize the default resolutions and whether you can change them.

Resolutions Used with Graphics Formats

Graphics Format	Default Resolution	Can Be Changed?
Built-in MATLAB export formats, (except for EMF, EPS, and ILL)	150 dpi (always use OpenGL or Z-buffer)	Yes
EMF export format (Enhanced Metafile)	150 dpi	Yes
EPS (Encapsulated PostScript)	150 dpi, if OpenGL or Z-buffer; 864 dpi if Painter's	Yes
ILL export format (Adobe Illustrator)	72 dpi (always uses Painter's)	No
Ghostscript export formats	72 dpi (always uses OpenGL or Z-buffer)	No

Resolutions Used with Printer Drivers

Printer Driver	Default Resolution	Can Be Changed?
Windows and PostScript drivers	150 dpi, if OpenGL or Z-buffer; 864 dpi if Painter's	Yes
Ghostscript driver	150 dpi, if OpenGL or Z-buffer; 864 dpi if Painter's	Yes
HPGL driver	1116 dpi (always uses Painter's)	Yes

Choosing a Setting

You might need to determine your resolution requirements through experimentation, but you can also use the following guidelines.

For Printing. The default resolution of 150 dpi is normally adequate for typical laser-printer output. However, if you are preparing figures for high-quality printing, such as a textbook or color brochures, you might want to use 200 or 300 dpi. The resolution you can use can be limited by the printer's capabilities.

For Exporting. If you are exporting your figure, base your decision on the resolution supported by the final output device. For example, if you will import your figure into a word processing document and print it on a printer that supports a maximum resolution setting of 300 dpi, you could export your figure using 300 dpi to get a precise one-to-one correspondence between pixels in the file and dots on the paper.

Note The only way to set resolution when exporting is with the print function.

Impact of Resolution on Size and Memory Needed

Resolution affects file size and memory requirements. For both printing and exporting, the higher the resolution setting, the longer it takes for MATLAB or your printer to render your figure.

Using the Graphical User Interface on Windows

To set the resolution for built-in MATLAB printer drivers on Windows systems,

- 1** From the **Print** dialog box, click **Properties**. This opens a new dialog box. (This box can differ from one printer to another.)
- 2** You may be able to set the resolution from this dialog. If not, then click **Advanced** to get to a dialog box that enables you to do this.
- 3** Set the resolution, and then click **OK**. (The resolution setting might be labeled by another name, such as "Print Quality.")

Using the Graphical User Interface on UNIX

To set the resolution for built-in MATLAB printer drivers on UNIX systems,

- 1** From the UNIX **Print** dialog box, click **Options**. This opens the **Printing Options** dialog box.
- 2** Under the **Printing Resolution** panel, select either **Use same resolution as the screen** or **Specify resolution in dots per inch**.
- 3** If you select **Specify resolution in dots per inch**, enter a value in the **Specify resolution in dots per inch** text box.
- 4** Click **OK**.

Using MATLAB Commands

If you use a Windows printer driver, you can only set the resolution using the Windows **Document Properties** dialog box.

Otherwise, to set the resolution for printing or exporting, the syntax is

```
print -rnumber
```

where number is the number of dots per inch. To print or export a figure using screen resolution, set number to 0 (zero).

This example prints the current figure with a resolution of 100 dpi:

```
print -r100
```

This example exports the current figure to a TIFF file using screen resolution:

```
print -r0 -dtiff myfile.tif
```

Setting the Axes Ticks and Limits

The MATLAB default output size, 8-by-6 inches, is normally larger than the screen size. If the size of your printed or exported figure is different from its size on the screen, MATLAB scales the number and placement of axes tick marks to suit the output size. This section shows you how to lock them so that they are the same as they were when displayed.

You can change the resolution that MATLAB uses to print a figure:

- “Using the Graphical User Interface”
- “Using MATLAB Commands” on page 7-56

Using the Graphical User Interface

Select **Page Setup** from the figure window's **File** menu to open the **Page Setup** dialog box. Select the **Axes and Figure** tab to make changes to the axes, UI controls, background color, or renderer selection.

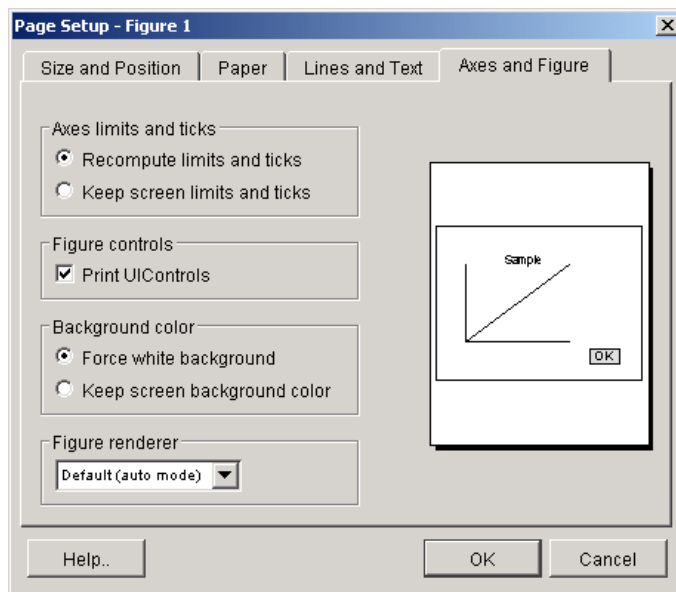

Settings you can change in the **Axes and Figure** window are as follows:

Axes limits and ticks. If the size of your printed or exported figure is different from its size on the screen, MATLAB scales the number and placement of axes tick marks to suit the output size. Select **Keep screen limits and ticks** to lock them so that they are the same as they were when displayed.

Figure controls. By default, user interface controls are included in your printed or exported figure. Clear the **Print UIControls** check box to exclude them. (See “Excluding User Interface Controls” on page 7-62).

Background color. You can keep the background the same as is shown on the screen when printed, or change the background to be white. (See “Setting the Background Color” on page 7-56).

Figure renderer. Set the renderer to Painter’s, Z-buffer, or OpenGL, or let MATLAB decide which one to use, depending on the characteristics of the figure. (See “Selecting a Renderer” on page 7-48).

Note Changes you make using **Page Setup** affect the printed output only. They do not alter the figure displayed on your screen.

Using MATLAB Commands

To set the `XTickMode`, `YTickMode`, and `ZTickMode` properties to manual, type

```
set(gca, 'XTickMode', 'manual');  
set(gca, 'YTickMode', 'manual');  
set(gca, 'ZTickMode', 'manual');
```

Setting the Background Color

There are two types of background color settings in a figure: the axes background and the figure background. The default displayed color of both backgrounds is gray, but you can set them to any of several colors.

Regardless of the background colors in your displayed figure, by default, MATLAB always changes them to white when you print or export. This section shows you how to retain the displayed background colors in your output.

Using the Graphical User Interface

To retain the background color on a per figure basis,

- 1 Open the **Page Setup** dialog box by selecting **Page Setup** from the figure window’s **File** menu. Select the **Axes and Figure** tab.
- 2 Select **Keep screen background color**.
- 3 Click **OK**.

If you are exporting your figure using the clipboard, use the **Copy Options** panel of the **Preferences** dialog box.

Using MATLAB Commands

To retain your background colors, use

```
set(gcf, 'InvertHardCopy', 'off');
```

The following example sets the figure background color to blue, the axes background color to yellow, and then sets `InvertHardCopy` to off so that these colors will appear in your printed or exported figure.

```
set(gcf, 'color', 'blue');  
set(gca, 'color', 'yellow');  
set(gcf, 'InvertHardCopy', 'off');
```

Setting Line and Text Characteristics

If you transfer your figures to Word or PowerPoint applications, you can set line and text characteristics to values recommended for those applications. The **Figure Copy Template Preferences** dialog box provides **Word** and **PowerPoint** options to make these settings, or you can set certain line and text characteristics individually.

You can change line and text characteristics:

- “Using the Graphical User Interface”
- “Using MATLAB Commands” on page 7-59

Using the Graphical User Interface

To open **Figure Copy Template Preferences**, select **Preferences** from the figure window's **File** menu, and then click **Figure Copy Template** in the left pane.

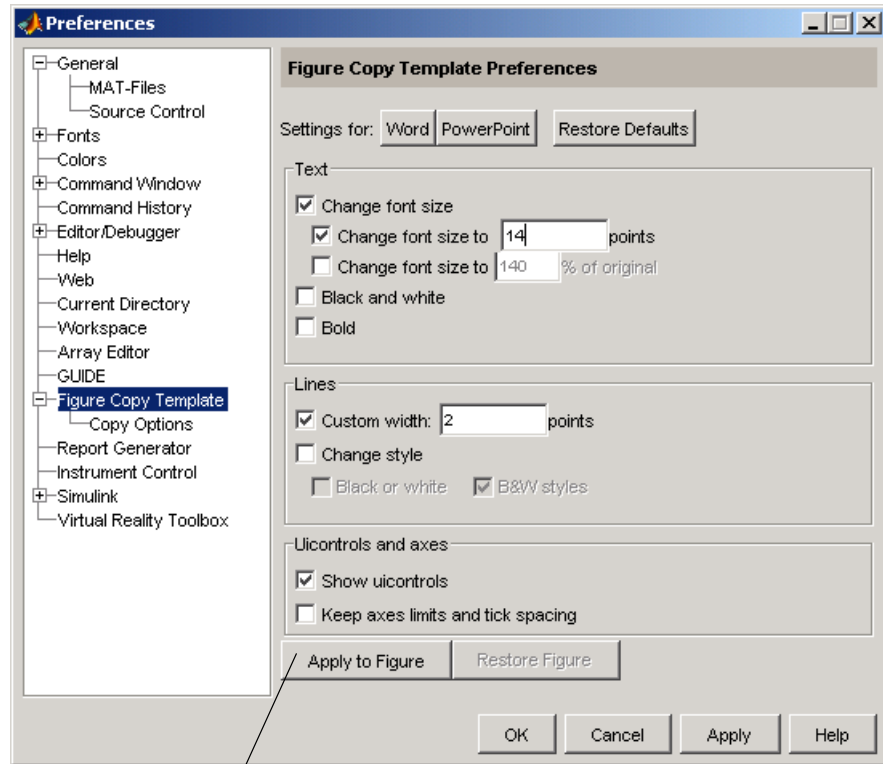

Note the difference between **Apply to Figure** and **Apply**. Use **Apply to Figure** to modify the figure in the figure window. Use **Apply** or **OK** to save your preferences.

Settings you can change in the **Figure Copy Template Preferences** dialog box are as follows:

Word or PowerPoint. Click **Word** or **PowerPoint** to apply settings recommended for MATLAB.

Text. Use options in the **Text** panel to modify the appearance of all text in the figure. You can change the font size, change color text to black and white, and change the font style to bold.

Lines. Use the **Lines** panel to modify the appearance of all lines in the figure. Options include

- **Custom width** — Change the line width.
- **Change style (Black or white)** — Change colored lines to black or white.
- **Change style (B&W styles)** — Change solid lines to different line styles (e.g., solid, dashed, etc.), and black or white color.

UIControls and axes. If your figure includes user interface controls, you can choose to show or hide them by clicking **Show uicontrols**. Also, to keep axes limits and tick marks as they appear on the screen, click **Keep axes limits and tick spacing**. To allow MATLAB to scale axes limits and tick marks based on the size of the printed figure, clear this box.

Note Changes you make using **Page Setup** affect the printed output only. They do not alter the figure displayed on your screen.

Using MATLAB Commands

You can use the `set` function on selected graphics objects in your figure to change individual line and text characteristics.

For example, to change line width to 1.8 and line style to a dashed line, use

```
lineobj = findobj('type', 'line');  
set(lineobj, 'linewidth', 1.8);  
set(lineobj, 'linestyle', '--');
```

To change the font size to 15 points and font weight to bold, use

```
textobj = findobj('type', 'text');  
set(textobj, 'fontunits', 'points');  
set(textobj, 'fontsize', 15);  
set(textobj, 'fontweight', 'bold');
```

Setting the Line and Text Color

When colored lines and text are dithered to gray by a black-and-white printer, it does not produce good results for thin lines and the thin lines that make up text characters. You can, however, force all line and text objects in the figure to

print in black and white, thus improving their appearance in the printed copy. When you select this setting, the lines and text are printed all black or all white, depending on the background color.

The default is to leave lines and text in the color that appears on the screen.

Note Your background color might not be the same as what you see on the screen. See the **Axes and Figure** tab for an option that preserves the background color when printing.

You can change the resolution that MATLAB uses to print a figure:

- “Using the Graphical User Interface” on page 7-60
- “Using MATLAB Commands” on page 7-61

Using the Graphical User Interface

Select **Page Setup** from the figure window’s **File** menu to open the **Page Setup** dialog box. Select the **Lines and Text** tab to make changes to the color of all lines and text on the printed page.

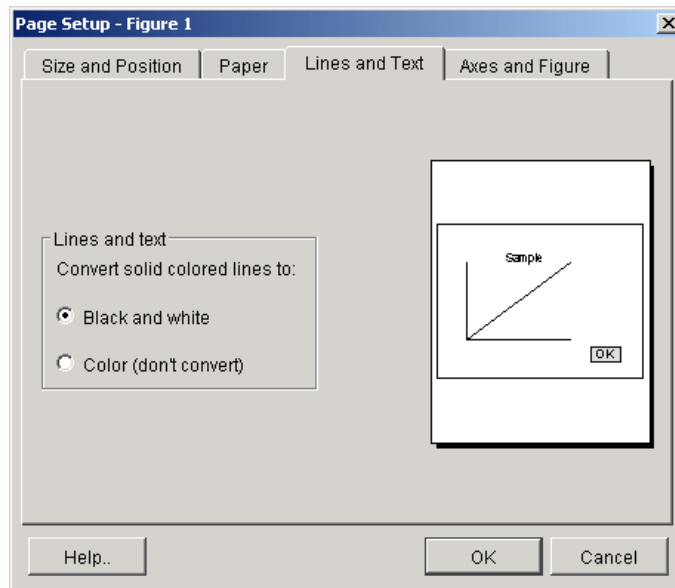

Settings you can change in the **Lines and Text** window are as follows:

Lines and text. To have colored lines and text printed as black and white, select **Black and white**. To print them in color, select **Color (don't convert)**.

Note Changes you make using **Page Setup** affect the printed output only. They do not alter the figure displayed on your screen.

Using MATLAB Commands

There is no equivalent MATLAB command that sets line and text color depending on background color. Set the color of lines and text using the `set` function on either line or text objects in your figure.

This example sets all lines and text to black:

```
set(findobj('type', 'line'), 'color', 'black');  
set(findobj('type', 'text'), 'color', 'black');
```

Setting CMYK Color

By default, MATLAB produces color output in the RGB color space (red, green, blue). If you plan to publish and print MATLAB figures using printing industry standard four-color separation, you might want to use the CMYK color space (cyan, magenta, yellow, black).

Using the Graphical User Interface on UNIX

- 1 Select **Print** from the figure window's **File** menu.
- 2 Click **Options**. This opens the **Printing Options** dialog box.
- 3 Select **Use CMYK colors in PS and Ghostscript drivers instead of RGB**.
- 4 Click **OK**.

Using MATLAB Commands

Use the `-cmyk` option with the `print` function. This example prints the current figure in CMYK using a PostScript Level II color printer driver.

```
print -dpsc2 -cmyk
```

Excluding User Interface Controls

User interface controls are objects that you create and add to a figure. For example, you can add a button to a figure that, when clicked, conveniently runs another M-file. By default, user interface controls are included in your printed or exported figure. This section shows how to exclude them.

Using the Graphical User Interface

- 1 Open the **Page Setup** dialog box by selecting **Page Setup** from the figure window's **File** menu. Select the **Axes and Figure** tab.
- 2 Under **Figure controls**, clear the **Print UIControls** check box.
- 3 Click **OK**.

Using MATLAB Commands

Use the `-noui` switch. This example specifies a color PostScript driver and excludes UI controls.

```
print -dpsc -noui
```

This example exports the current figure to a color EPS file and excludes UI controls.

```
print -depvc -noui myfile.eps
```

Producing Uncropped Figures

In most cases, MATLAB crops the background tightly around the objects in the figure. Depending on the printer driver or file format you use, you might be able to produce uncropped output. An uncropped figure has increased background area and is often desirable for figures that contain UI controls.

The setting you make in MATLAB changes the PostScript `BoundingBox` property saved with the figure.

Using the Graphical User Interface on UNIX

You can only make the uncropped setting on a per figure basis:

- 1 Select **Print** from the figure window's **File** menu.
- 2 From the UNIX **Print** dialog box, click **Options**. This opens the **Printing Options** dialog box.
- 3 Select **Use loose bounding box for PS and Ghostscript drivers**.
- 4 Click **OK**.

Using MATLAB Commands

Use the `-loose` option with the `print` function. For Windows, the uncropped option is only available if you print to a file.

This example exports the current figure, uncropped, to an EPS file.

```
print -deps -loose myfile.eps
```

Choosing a Graphics Format

A graphics file format is a specification for storing and organizing data in a file. MATLAB supports many different graphics file formats. Some are built into MATLAB and others are Ghostscript formats. File formats also differ in color support, graphics style (bitmap or vector), and bit depth.

This section provides information to help you decide which graphics format to use when exporting your figure to a file or to the Windows clipboard. It covers

- “Frequently Used Graphics Formats” on page 7-65
- “Factors to Consider in Choosing a Format” on page 7-66
- “Properties Affected by Choice of Format” on page 7-68
- “Impact of Rendering Method on the Output” on page 7-70
- “Description of Selected Graphics Formats” on page 7-70
- “How to Specify a Format for Exporting” on page 7-74

Before deciding on a graphics format, check what formats are supported by your target application and platform. See the print reference page for a complete list of graphics formats supported in MATLAB. Once you decide on which format to use in exporting your figure, follow the instructions in “Exporting to a File” on page 7-17 or “Exporting to the Windows Clipboard” on page 7-27.

Frequently Used Graphics Formats

Here are some of the more frequently used graphics formats. For a complete list, see the Graphics Format table on the print reference page. For a more complete description of these formats, see “Description of Selected Graphics Formats” on page 7-70.

Format	Description	Command Line -device Parameter
EPS color, and black and white	Export line plots or simple graphs to a file. Note. An EPS file does not display within some applications unless you add a TIFF preview image to it. See the example “Exporting in EPS Format with a TIFF Preview” on page 7-34.	-deps (black and white) -depsec (color) -depsec -tiff (TIFF preview)
JPEG 24-bit	Export plots with surface lighting or transparency to a file. This format can be displayed by most Web browsers.	-djpeg -djpegnumber, where <i>number</i> is the compression.
TIFF 24-bit bitmap color	Export plots with surface lighting or transparency to a file. Widely available. A good format to choose if you are not sure what formats your application supports.	-dtiff
BMP 8-bit color bitmap	Export a figure to the clipboard (Windows only).	-dbitmap
EMF color vector format	Export a figure to the clipboard (Windows only).	-dmeta

Factors to Consider in Choosing a Format

There are at least five main factors to consider when choosing a graphics format to use in exporting a figure:

- Implementation — Is it a built-in MATLAB or Ghostscript format?
- Graphics Format — Is it bitmap or vector graphics format?
- Bit Depth — What bit depth does the format offer?
- Color Support — What color support does it have?
- Model/Publication — Is it a Simulink® model or specific publication type?

The Graphics Format table shown on the print reference page provides information on the first four of these items for each format that MATLAB supports.

Built-In MATLAB or Ghostscript Formats

Some graphics formats are built-in MATLAB formats and others are provided by Ghostscript. In some cases (such as the Windows Bitmap format), the format is available both as a built-in format and a Ghostscript format. In general, when this is the case, we recommend that you choose the MATLAB format, especially if you plan to read the image back into MATLAB later.

The choice of MATLAB versus Ghostscript is important when any of these properties affects your output:

- Font support
- Resolution
- Importing back into MATLAB

Bitmap or Vector Graphics

MATLAB file formats are created using either bitmap or vector graphics. Bitmap formats store graphics as matrices of pixels. Vector formats use drawing commands to store graphics as geometric objects. Whether to use a bitmap or vector format depends mostly on the type of objects in your figure.

The choice of bitmap versus vector graphics is important when any of these properties or capabilities affects your output:

- Degree of complexity
- Lighting and transparency

- Line and text quality
- File size
- Resizing after import

Bit Depth

Bit depth is the number of bits a format uses to store each pixel. This determines the number of colors the exported figure can contain.

Bit depth applies mostly to bitmap graphics. An 8-bit image uses 8 bits per pixel (bpp), enabling it to define 2^8 , or 256, unique colors. The other supported bit depths are 1-bit (2 colors), 4-bit (16 colors), and 24-bit (16 million colors).

In vector files that don't normally have a bit depth, the color of objects is specified by drawing commands stored in the file. However, vector files can contain bitmaps under the following conditions:

- Image objects saved in vector formats are always saved as bitmaps, regardless of the rendering method used.
- For vector files created using the OpenGL or Z-buffer renderer, everything in the figure is saved as a bitmap.

The Graphics Format table on the print reference page indicates the bit depth of each format. If file size is not critical, make sure you choose a format with a bit depth that supports the number of colors or shades of gray in your displayed figure.

Color Support

Each graphics format can produce color, grayscale, or monochrome output. Check the Graphics Format table to see the level of color support for each format type. To preserve the color in your exported file, you must select a color graphics format. Color is also affected by bit depth.

Simulink Models

Simulink models can only be exported to EPS or a Ghostscript format. Note that you can only use the print function to export a model, not the **Export** dialog box.

High Resolution or Web Publications

If you want to use a figure in a journal or other publication, use a format that enables you to set a high resolution. We recommend using either TIFF or EPS.

If you want to use a figure in a Web publication, you should use either the PNG or the JPEG format. Note that if you need a GIF image, you can export your figure as a TIFF file and convert it to a GIF using another software application.

Properties Affected by Choice of Format

The figure properties listed in this section are affected when you select a graphics format when exporting to a file or the Windows clipboard.

Font Support

Ghostscript formats support a limited number of fonts. If you use an unsupported font, MATLAB substitutes Courier. See “PostScript and Ghostscript Supported Fonts” on page 7-78 for more information.

Resolution

Generally, higher resolution means higher quality. Your choice of resolution should be based in part on the device to which you will ultimately print it. Experimentation with different resolution settings can be helpful.

You cannot change the resolution of a Ghostscript format. The resolution is low (72 dpi) and may not be appropriate for publications.

Importing Into MATLAB

If you want to read an exported figure back into MATLAB, it is best to use one of the built-in MATLAB formats.

Degree of Complexity

Bitmaps are preferable for high-complexity plots, where complexity is determined by the number of polygons, the number of polygons with interpolated shading, the number of markers, the presence of truecolor images, and other factors. An example of a high-complexity plot is a surface plot that uses interpolated shading.

Vector formats are preferable for most 2-D plots and for some low-complexity surface plots.

Lighting and Transparency

Surface lighting and transparency are only supported by bitmap graphics formats. If you use a vector format, the lighting and transparency disappear. Note that of the two renderers intended for bitmaps (OpenGL and Z-buffer) only OpenGL supports transparency.

Note If you export to an EPS (vector) file using the Painter's renderer and include a TIFF preview, the preview image is a bitmap and will show lighting or transparency when displayed on your screen. Remember that the underlying format vector file, which is what normally gets printed, does not support these features.

Lines and Text

Generally, vector formats create better lines and text than bitmap formats.

File Size

In general, bitmap formats produce smaller files for complex plots than vector formats, and vector formats produce smaller files for simple plots than bitmap formats.

You can calculate the size of a figure exported to an uncompressed bitmap by multiplying the figure size by its resolution and the bit depth of the chosen format. For example, if a figure is 2 inches by 3 inches and has a resolution of 100 dpi (dots per inch), it will consist of $2 \times 100 \times 3 \times 100$, or 60,000 pixels. If exported to an 8-bit file, it uses 480,000 bits, or 60 KB. If exported to a 24-bit file, it uses three times the number of bytes, or 180 KB.

Vector format file size is affected by the complexity and number of objects in your figure. As the complexity and number of objects increase, the number of drawing commands increases.

Resizing After Import

You can resize a vector graphics figure after importing it into another software application without losing quality. (Not all applications that support vector formats enable you to resize them.)

This is not true of bitmap formats. Resizing a bitmap causes round-off errors that result in jagged edges and degradation of picture quality. This degradation is particularly obvious in lines and text and is highly discouraged.

Color

The Graphics Format table on the print reference page indicates the color support and bit depth of each format. If file size is not critical, make sure you choose a format with a bit depth that supports the number of colors or shades of gray in your displayed figure.

Impact of Rendering Method on the Output

If you specify a bitmap format when exporting, the exported file will always contain a bitmap regardless of your current renderer setting. If you have the renderer set to Painter's, which normally produces a vector format, that setting is ignored under these circumstances.

Vector format files, however, can store your figure as a vector or bitmap graphic depending on the renderer used to export it. If you do not specify a rendering method and MATLAB chooses the OpenGL or Z-buffer renderer, your exported vector file will contain a bitmap. If you want your figure exported as a vector graphic, be sure to set the rendering method to Painter's.

Description of Selected Graphics Formats

This section contains details about some of the export file formats MATLAB supports. For information about formats not listed here, consult a graphics file format reference.

Formats covered in this section are

- “Adobe Illustrator 88 Files” on page 7-71
- “EMF Files” on page 7-71
- “EPS Files” on page 7-71
- “TIFF Files” on page 7-73
- “JPEG Files” on page 7-73

Adobe Illustrator 88 Files

Adobe Illustrator (ILL) is a vector format that is fully compatible with Adobe Illustrator software. An Illustrator file created in MATLAB can be further processed with Adobe Illustrator running on any platform. (Note that when you view it in Illustrator, it will have no template.)

By default, Illustrator files are color and saved in portrait orientation. The Illustrator group command is used to give the illustrations a hierarchy similar to that of the Handle Graphics or Simulink graphic.

Some limitations of the Illustrator format are

- Interpolated patches and surfaces cannot be created. The color of each polygon is determined by the average of the CData values for all of the polygon's vertices.
- Images cannot be exported in this format.
- The resolution setting of 72 dpi cannot be changed.
- No fonts are downloaded to the Illustrator file. Any unavailable fonts are replaced with fonts that are available.

EMF Files

Enhanced Metafiles (EMF) are vector files similar in nature to Encapsulated PostScript (EPS), capable of producing near publication-quality graphics. EMF is an excellent format to use if you plan to import your image into a Microsoft application and want the flexibility to edit and resize your image once it has been imported. It is the only MATLAB supported vector format you can edit from within a Microsoft application. (Note that your editing ability is limited. For the best results, do all your editing in MATLAB.)

A drawback of using EMF files is that they are generally only supported by Windows-based applications.

EPS Files

The Encapsulated PostScript (EPS) vector format is the most reliable and consistent file format MATLAB supports. It is widely recognized in desktop publishing and word processing packages on both UNIX and Windows platforms. EPS is the only MATLAB supported export format that can produce CMYK output. (PostScript printer drivers also support this feature.)

This format is your best choice for producing publication-quality graphics. It might not be appropriate for figures containing interpolated shading because it creates a very large file that is difficult to print. For such figures, use the TIFF format with a high-resolution setting. For more information about format choices, see “Bitmap or Vector Graphics” on page 7-66.

When imported into Microsoft applications, an EPS file will not display unless you add a TIFF preview image to it.

The preview image is simple to add (see the next section, “Creating a Preview Image”). However, if you print your file to a non-PostScript printer, the TIFF preview is used as the printed image. The resolution of the preview image is 72 dpi, resulting in much lower quality than the EPS image. If there is no preview image, your printout to a non-PostScript printer contains an error message in place of the graphic. Many high-end graphics packages, like Adobe Illustrator, can print an EPS file to a non-PostScript printer.

You cannot edit figures when using EPS files in Microsoft applications; they can only be annotated.

Note The best vector format to use with Microsoft applications is EMF. See “EMF Files” on page 7-71.

EPS format has limited font support. When MATLAB exports a graphic to the EPS file format, it does not try to determine whether the fonts you have used in your axes text objects are supported by the EPS format. Unsupported fonts are replaced with Courier.

Creating a Preview Image. You cannot create TIFF preview images using the graphical user interface. Use the print command with the `-tiff` switch. For example, to create an EPS Level 2 image with TIFF preview in file `myfile.eps`, type

```
print -depsc2 -tiff myfile.eps
```

TIFF Files

The Tagged Image File Format (TIFF) is a very widely used bitmap format and can produce publication-quality graphics if you use a high-resolution setting (such as 200 or 300 dpi).

TIFF is a good format to choose if you are not sure what formats your target application supports, or if you want to import the graphic into more than one application without having to export it to several different formats. It can also be imported into most image-processing applications and converted to other formats, if necessary. For example, MATLAB does not produce GIF files (because of patent restrictions), but there are many applications that can convert TIFF files to GIF.

JPEG Files

The Joint Photographic Experts Group (JPEG) bitmap format is one of the dominant formats used in Web graphics. The 24-bit version MATLAB supports more colors than the popular GIF format.

JPEG files always use JPEG compression. This is a lossy compression scheme, meaning that some data is thrown away during compression. When you export to a JPEG image, you can set the amount of compression to use. The more compression you use, the more data is thrown away. The compression amount is referred to as JPEG quality, where the highest setting results in the highest quality image, but the lowest amount of compression.

Setting JPEG Quality. You cannot set the quality using the graphical user interface. Use the `print` command with the `-djpeg` format switch, including the desired quality value as a suffix. This example exports to a JPEG file using a quality setting of 100.

```
print -djpeg100 myfile.jpg
```

By default, MATLAB uses a quality setting of 75. Possible values are from 1 to 100. Note that the highest setting of 100 still results in some data loss, although the result is usually visually indistinguishable from the original.

How to Specify a Format for Exporting

To select a graphics format to use when exporting, choose a format from the Graphics Format table on the print reference page, and specify that format in either the **Export** dialog box or in the MATLAB print function.

Using the Graphical User Interface

When exporting your figure to a file,

- 1** Select **Export** from the figure window's **File** menu.
- 2** Select a format from the **Save as type** list box.
- 3** Enter the filename you want to use and browse for the directory to save the file in.
- 4** Click **Save**.

Using MATLAB Commands

To specify a nondefault graphics format for the figure you are exporting, include the `-d` switch with the `print` command. For example, to export the current figure to file `spline2d.eps`, with 600 dpi resolution, and using the EPS color graphics format, type

```
print -r600 -depsc spline2d
```

Note When printing, the `print -d` option specifies a printer driver. When exporting, the `print -d` option specifies a graphics format.

Choosing a Printer Driver

A MATLAB printer driver formats your figure into instructions that your printer understands. See the Printer Driver table on the print reference page for a complete list of drivers. Specifying the printer driver does not change the selected printer.

This section provides information to help you decide which printer driver to use when printing your figure. It covers

- “Types of Printer Drivers”
- “Factors to Consider in Choosing a Driver” on page 7-76
- “Driver-Specific Information” on page 7-79
- “How to Specify the Printer Driver to Use” on page 7-83

Types of Printer Drivers

There are two main types of MATLAB printer drivers: built-in MATLAB, and Ghostscript.

Built-in MATLAB Drivers

Built-in MATLAB drivers are written specifically for MATLAB and include Windows, PostScript, and HPGL.

MATLAB provides built-in Windows printer drivers so that your print requests can work with the Windows Print Manager. The Print Manager enables you to monitor printer queues and control various aspects of the printing process.

HPGL support is provided for the HP 7475A plotter and fully compatible plotters. HPGL files can also be imported into documents of other applications, such as Microsoft Word.

Ghostscript Drivers

Ghostscript drivers use Ghostscript, a free software conversion program, to convert your figure into printer-model-specific instructions. Examples of Ghostscript drivers are Epson and HP.

Factors to Consider in Choosing a Driver

The choice of printer driver depends upon several considerations:

- What platform you are using
- What kind of printer you have
- What color model you want to use
- What font support you need
- Any driver-specific settings you need

The flow chart below gives an overview of how to choose a driver based on the platform you are using and the type of printer you have.

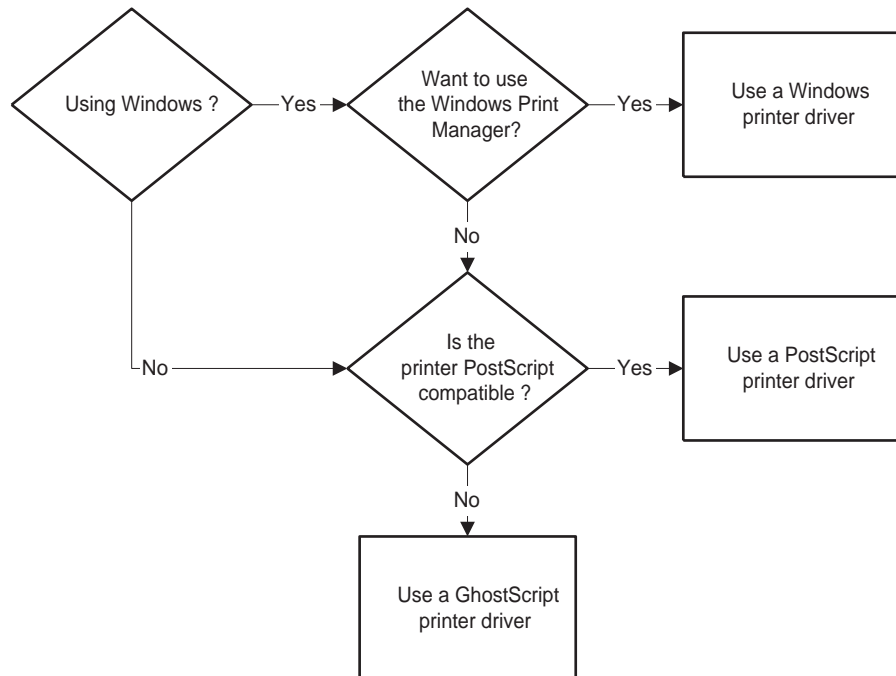

Deciding What Type of Printer Driver to Use

Platform Considerations

On Windows, you can use any of the driver types shown in the figure above. If you use the Windows driver, you can use the Windows Print Manager.

On UNIX, you can use either PostScript or Ghostscript drivers.

On either platform, if you have a PostScript-compatible printer, it is better to use a PostScript driver than a Ghostscript driver. PostScript is less prone to printing errors than Ghostscript.

Printer Type

Printer support is different among the Windows, PostScript, and Ghostscript drivers. Consult the manual for your printer to see what driver to use.

Windows drivers support most printer models, but sometimes the printer's native driver is incompatible with the MATLAB Windows driver. If you are getting printing errors, see "Trouble with Native Drivers on Windows" on page 7-81. If lines and text in your figure are not printing with the desired color scheme, see "Correcting Color Results with Windows Drivers" on page 7-80.

Some Ghostscript drivers are specific to certain printer models. For example, MATLAB provides different drivers to support the HP DeskJet 500, 500C, and 550C models, plus a generic driver for the series. When this is the case, try the model-specific driver first. If that doesn't work, try the generic driver.

Color Model

By default, MATLAB uses a black-and-white driver. The built-in MATLAB and Ghostscript drivers print both color and black and white. The Printer Drivers table on the print reference page indicates which drivers are color.

Colored surfaces and images print in grayscale when you use a black-and-white driver. Colored lines and text can be printed in color, grayscale, or black and white, depending on the color support of the driver and color capability of your printer.

Font Support

In MATLAB, the fonts supported for printing depend upon the MATLAB printer driver you specify and sometimes upon which platform you are using.

PostScript and Ghostscript Supported Fonts. The table below lists the fonts supported by the MATLAB PostScript and Ghostscript drivers. This same set of fonts is supported on both Windows and UNIX. If you use a font that is not on this list, it is replaced with Courier.

AvantGarde	Helvetica-Narrow	Times-Roman
Bookman	NewCenturySchlbk	ZapfChancery
Courier	Palatino	ZapfDingbats
Helvetica	Symbol	

If you set the font using the `set` function, use the names exactly as shown above. This example sets the font of the current text object to Helvetica-Narrow using MATLAB commands.

```
set(gca, 'FontName', 'Helvetica-Narrow');
```

If you use the **Property Editor** dialog box (available under **Axes Properties** or **Current Object Properties** on the **Edit** menu) to set the font, the list of available fonts shows those that are supported by your system. If you choose one that is not in the table above, your resulting file will use Courier.

Windows Drivers Supported Fonts. The MATLAB Windows drivers support any system-supported font. To see the list of fonts installed on your system, open the **Font name** list on the **Text** or **Style** tab of the Property Editor.

If you use the `set` function to set fonts, type in the name just as it appears in the Property Editor. For example, if you have the Script font installed on your system, set the title of your figure to Script using the following code.

```
h = get(gca, 'Title');
set(h, 'FontName', 'Script');
```

HPGL Driver Supported Fonts. HPGL drivers support only one font. However, you can set its size and color.

Settings That Are Driver Specific

Some print settings are only supported by specific drivers. This table summarizes the settings and which driver supports them.

Setting	Driver(s)
Appending figures to a PostScript file	PostScript
BoundingBox (setting figure to print uncropped)	PostScript, Ghostscript
CMYK	PostScript
Resolution set with user interface	PostScript, Windows
Resolution set with print function	PostScript, Ghostscript

Driver-Specific Information

This section provides additional information about the various types of printer drivers available to MATLAB users. It covers the following topics:

- “Setting the Windows Driver”
- “Correcting Color Results with Windows Drivers” on page 7-80
- “Trouble with Native Drivers on Windows” on page 7-81
- “Level 1 or Level 2 PostScript Drivers” on page 7-81
- “Early PostScript 1 Printers” on page 7-81
- “Background Fills in HPGL Drivers” on page 7-82
- “Color Selection in HPGL Drivers” on page 7-82
- “Limitations of HPGL Drivers” on page 7-83

Setting the Windows Driver

When you specify a Windows driver (`-dwin` or `-dwinc`), MATLAB interprets this to mean that the print request will use the Windows Print Manager. It also means that MATLAB will assign the default Windows driver based on your current printer’s color property setting. In other words, MATLAB does not differentiate between `-dwin` or `-dwinc` in `printopt.m` and you might not get the expected output color.

There are two ways to ensure that MATLAB uses `-dwin` or `-dwinc`: specify the driver when you print, or use the Windows **Document Properties** dialog box to set the default driver.

You can use the printer's **Document Properties** dialog box to set the default driver for all print requests. This dialog box sets the printer's color property, which in turn sets the default Windows driver.

To access this dialog box, click the **Options** button on the Windows **Print** or **Print Setup** dialog box. See your Windows documentation if you need help with this dialog box. **Document Properties** dialog boxes vary from printer to printer. The figure below shows an example of one.

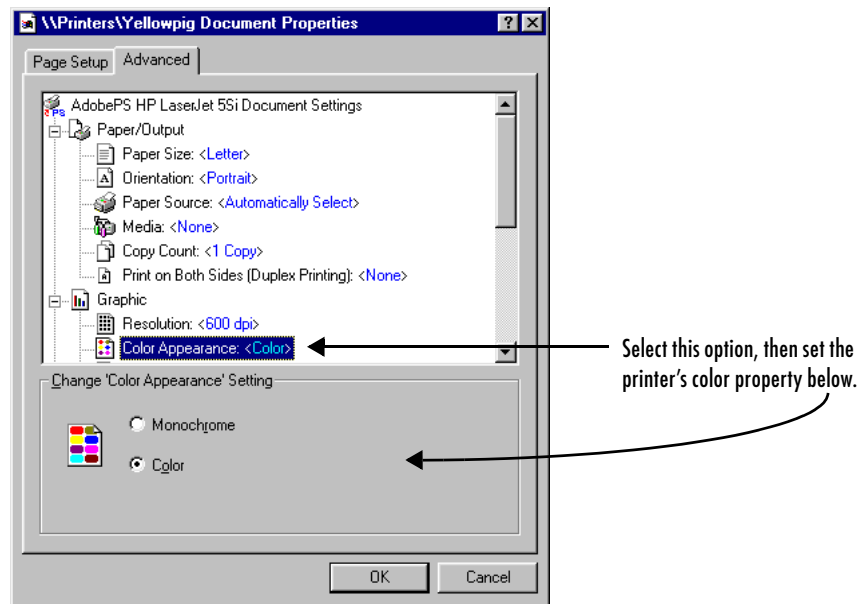

Windows Document Properties Dialog Box for an HP LaserJet 55i

Correcting Color Results with Windows Drivers

Sometimes, even when you use the Windows **Document Properties** dialog box, you can receive incorrect color results because some Windows printers return inaccurate information about their color property setting.

If this happens, you can use the figure window's **Preferences** dialog box to override the color property. This setting is used as the default setting for all future print operations:

- 1** Select **Preferences** from the figure window's **File** menu or from the **File** menu on the MATLAB Command Window.
- 2** Select **General Preferences**.
- 3** Under the **Figure Window Printing** panel, select **Always send as color**.
- 4** Click **OK**.

Trouble with Native Drivers on Windows

Occasionally, printing problems are due to a bug in the native printer driver or an incompatibility between the native printer driver and the MATLAB driver.

If you are having trouble, try installing a different native printer driver. A newer version might be available from the manufacturer or from a different vendor. You may also be able to use the native driver from a different printer, such as an earlier model from the same manufacturer.

If this doesn't help, try using a PostScript or Ghostscript driver.

Level 1 or Level 2 PostScript Drivers

Choosing between the Level 1 and Level 2 MATLAB PostScript drivers does not affect the quality of your output. Make the choice based on what your printer supports and on any file size or speed concerns.

Level 1 PostScript produces good results on a Level 2 printer, but Level 2 PostScript does not print properly on a Level 1 printer.

Level 2 PostScript files are generally smaller and render more quickly than Level 1 files. If your printer supports Level 2 PostScript, use one of the Level 2 drivers. If your printer does not support Level 2, or if you're not sure, use a Level 1 driver.

Early PostScript 1 Printers

If you have an early PostScript 1 printer, such as some of the PostScript printers manufactured before 1990, you may notice problems in the text of MATLAB printouts. Your printer might not support the `ISOlatin1Encoding`

operator that MATLAB uses for PostScript files. If this is the case, use Adobe's PostScript default character-set encoding:

- UNIX only: Open the **Print** dialog box and click **Options**. This opens the **Printing Options** dialog box. Select **Use Adobe PS default character set encoding**.
- Specify the `-adobecset` option with the `print` command.

Background Fills in HPGL Drivers

The HPGL driver cannot do background fills. Therefore, you should ensure that your figure is set to print with a white background (the default), and that any lines and text in your figure are drawn in a color dark enough to be seen on a white background. For more information about background color, see "Setting the Background Color" on page 7-56.

Color Selection in HPGL Drivers

The HP 7475A plotter supports six pens, none of which can be white. If MATLAB tries to draw in white while rendering in HPGL mode, the driver ignores all drawing commands until a different color is chosen.

Pen 1, which is assumed to be black, is used for drawing axes. The remaining pens are used for the first five colors specified in the `ColorOrder` property of the current axes object. If `ColorOrder` specifies fewer than five colors, the unspecified pens are not used.

For Simulink systems, which ordinarily use a maximum of eight colors, the six pens available on the plotter are assumed to be

- Pen 1: black
- Pen 2: red
- Pen 3: green
- Pen 4: blue
- Pen 5: cyan
- Pen 6: magenta

If you attempt to draw a MATLAB object containing a color that is not a known pen color, the driver chooses the nearest approximation to the unlisted color.

Limitations of HPGL Drivers

The HPGL driver has these limitations:

- Display colors and plotted colors sometimes differ.
- Areas (faces on mesh and surface plots, patches, blocks, and arrowheads) are not filled.
- There is no hidden line or surface removal.
- Text is printed in the plotter's default font.
- Line width is determined by pen width.
- Images and UI controls cannot be plotted.
- Interpolated edge lines between two vertices are drawn with the pen whose color best matches the average color of the two vertices.
- Figures cannot be rendered using Z-buffer or OpenGL; this driver always uses the Painter's algorithm.

How to Specify the Printer Driver to Use

If you need to use a driver other than the default driver for your system, choose a new driver from the Printer Driver table on the print reference page, and set it either as a new default or just for the current figure you are working on.

Setting the Default Driver for All Figures

If you do not indicate a specific printer driver, MATLAB uses the default driver specified by the variable `dev` in the `printopt.m` file. The factory default driver depends on the platform.

Platform	Factory Default Printer Driver	Driver Code
Windows	Black-and-white Windows	-dwin
UNIX	Black-and-white Level II PostScript	-dps2

To change the default driver for all figures, edit `printopt.m` and change the value for `dev` to match one of the driver codes listed in the Printer Drivers table

on the `print` reference page. See “Setting Defaults Across Sessions” on page 7-7 for instructions.

Setting a Driver for the Current Figure Only

You can change the printer driver using a UNIX dialog box or from the MATLAB command line.

Using the Graphical User Interface on UNIX. To specify a printer driver for the current figure,

- 1** From the figure window’s **File** menu, select **Print**.
- 2** Select a printer driver from the **Driver** list.
- 3** Click **OK** to print your figure.

Using MATLAB Commands. To specify a nondefault printer driver for the figure you are printing, include the `-d` switch with the `print` command. For example, to print the current figure using the MATLAB built-in Windows color printer driver `winc`, type

```
print -dwinc
```

Note When printing, the `print -d` option specifies a printer driver. When exporting, the `print -d` option specifies a graphics format.

Troubleshooting

This section lists some common problems you might encounter when printing or exporting your figure. Refer to the appropriate section listed below:

- **Printing Problems**
 - “Printer Drivers” on page 7-86
 - “Default Settings” on page 7-87
 - “Color vs. Black and White” on page 7-87
 - “Printer Selection” on page 7-88
 - “Rotated Text” on page 7-88
 - “ResizeFcn Warning” on page 7-88
- **Exporting Problems**
 - “Background Color” on page 7-89
 - “Default Settings” on page 7-89
 - “Microsoft Word” on page 7-89
 - “File Format” on page 7-90
 - “Size of Exported File” on page 7-91
 - “Making Movies” on page 7-91
 - “Extended Operations” on page 7-91
- **General Problems**
 - “Background Color” on page 7-92
 - “Default Settings” on page 7-92
 - “Dimensions of Output” on page 7-93
 - “Axis and Tick Labels” on page 7-93
 - “UI Controls” on page 7-94
 - “Cropping” on page 7-94
 - “Text Object Font” on page 7-94

If you don't find your problem listed here, try searching the Knowledge Base maintained by the MathWorks Technical Support Department. Go to <http://www.mathworks.com/support> and enter a topic in the search field.

Printing Problems

Printer Drivers

I'm using a Windows printer driver and have been encountering problems such as segmentation violations, general protection faults, application errors, and unexpected output.

Try one of the following solutions:

- Check the table of drivers in the print reference page to see if there are other drivers you can try.
 - If your printer is PostScript compatible, try printing with one of the MATLAB built-in PostScript drivers.
 - If your printer is not PostScript compatible, see if one of the MATLAB built-in Ghostscript devices is appropriate for your printer model. These devices use Ghostscript to convert PostScript files into other formats, such as HP LaserJet and Canon BubbleJet.
- Contact the printer vendor to obtain a different native printer driver. The behavior you are experiencing might occur only with certain versions of the native printer driver. If this doesn't help and you are using Windows, try reinstalling the drivers that were shipped with your Windows installation disk.
- Export the figure to a graphics-format file, and then import it into another application before printing it. For information about exporting figures with MATLAB, see "Exporting to a File" on page 7-17.

When I use the print function with the -deps switch, I receive this error message.

```
Encapsulated PostScript files cannot be sent to the printer.  
File saved to disk under name 'figure2.eps'
```

As the error message indicates, your figure was saved to a file. EPS is a graphics file format and cannot be sent to a printer using a printer driver. To send your figure directly to a printer, try using one of the PostScript driver switches. See the table of drivers in the print reference page. To print an EPS file, you must first import it into a word processor or other software program.

Default Settings

My printer uses a different default paper type than the MATLAB default type of “letter.” How can I change the default paper type so that I won’t have to set it for each new figure?

You can set the default value for any property by adding a line to `startup.m`. Adding the following line sets the default paper type to A4.

```
set(0, 'DefaultFigurePaperType', 'A4');
```

In your call to `set`, combine the word `Default` with the name of the object `Figure` and the property name `PaperType`.

I set the paper orientation to landscape, but each time I go to print a new figure, the orientation setting is portrait again. How can I change the default orientation so that I won’t have to set it for each new figure?

See the explanation for the question above. Adding the following line to `startup.m` sets the default paper orientation to landscape.

```
set(0, 'DefaultFigurePaperOrient', 'landscape')
```

Color vs. Black and White

I want the lines in my figure to print in black, but they keep printing in color.

You must be using a color printer driver. You can specify a black-and-white driver using the `print` function or the **Page Setup** dialog box to force the lines for the current figure to print in black. See “Setting the Line and Text Color” on page 7-59 for instructions.

A white line in my figure keeps coming out black when I print it.

There are two things that can cause this to happen. Most likely, the line is positioned over a dark background. By default, MATLAB inverts your background to white when you print, and changes any white lines over the background to black. To avoid this, retain your background color when you print. See “Setting the Background Color” on page 7-56.

The other possibility is that you are using a Windows printer driver and the printer is sending inaccurate color information to MATLAB. See “Correcting Color Results with Windows Drivers” on page 7-80.

I am using a color printer, but my figure keeps printing in black and white.

By default, MATLAB uses a black-and-white printer driver. You need to specify a color printer driver. For instructions, see “Choosing a Printer Driver” on page 7-75. If you are already using a Windows color driver, the printer might be returning inaccurate information about its color property. See “Correcting Color Results with Windows Drivers” on page 7-80.

Printer Selection

I have more than one printer connected to my system. How do I specify which one to print my figure with?

You can use either the **Print** dialog box, or the MATLAB print function, specifying the printer with the `-P` switch. For instructions using either method, see “Selecting the Printer” on page 7-40.

Rotated Text

I have some rotated text in my figure. It looks fine on the screen, but when I print it, the resolution is poor.

You are probably using bitmapped fonts, which don’t rotate well. Try using TrueType fonts instead.

ResizeFcn Warning

I get a warning about my ResizeFcn being used when I print my figure.

By default, MATLAB resizes your figure when converting it to printer coordinates. Therefore, MATLAB calls any `ResizeFcn` you have created for the figure and issues a warning. You can avoid this warning by setting the figure to print at screen size.

Exporting Problems

Background Color

I generated a figure with a black background and selected “Use figure color” from the Copy Options panel of the Preferences dialog box. But when I exported my figure, its background was changed to white.

You must have exported your figure to a file. The settings in **Copy Options** only apply to figures copied to the clipboard.

There are two ways to retain the displayed background color: use the **Page Setup** dialog box or set the `InvertHardCopy` property to off. See “Setting the Background Color” on page 7-56 for instructions on either method.

Default Settings

I want to export all of my figures using the same size. Is there some way to do this so that I don't have to set the size for each individual figure?

You can set the default value for any property by adding a line to `startup.m`. Adding the following line sets the default figure size to 4-by-3 inches.

```
set(0, 'DefaultFigurePaperPosition', [0 0 4 3]);
```

In your call to `set`, combine the word `Default` with the name of the object `Figure` and the property name `PaperPosition`.

I use the clipboard to export my figures as metafiles. Is there some way to force all of my copy operations to use the metafile format?

Use the **Copy Options** panel of the **Preferences** dialog box. Any settings made here, including whether MATLAB copies your figure as a metafile or bitmap, apply to all copy operations. See “Exporting to the Windows Clipboard” on page 7-27 for instructions.

Microsoft Word

I exported my figure to an EPS file, and then tried to import it into my Word document. My printout has an empty frame with an error message saying that my EPS picture was not saved with a preview and will only print to a PostScript printer. How do I include a TIFF preview?

Use the print command with the `-tiff` switch. For example,

```
print -deps -tiff filename
```

Note that if you print to a non-PostScript printer with Word, the preview image is used for printing. This is a low-resolution image that lacks the quality of an EPS graphic. For more information about preview images and other aspects of EPS files, see “EPS Files” on page 7-71.

When I try to resize my figure in Word, its quality suffers.

You must have used a bitmap format. Bitmap files generally do not resize well. If you are going to export using a bitmap format, try to set the figure’s size while it’s still in MATLAB. See “Setting the Figure Size and Position” on page 7-41 for instructions.

As an alternative, you can use one of the vector formats, EMF or EPS. Figures exported in these formats can be resized in Word without affecting quality.

I exported my figure as an EMF to the clipboard. When I paste it into Word, some of the labels are printed incorrectly.

This problem occurs with some versions of Word and Windows. Try editing the labels in Word.

File Format

I tried to import my exported figure into a word processing document, but I got an error saying the file format is unrecognized.

There are two likely causes: you used the print function and forgot to specify the export format, or your word processing program does not support the export format. Include a format switch when you use the print function; simply including the file extension is not sufficient. For instructions, see “Exporting to a File” on page 7-17.

If this does not solve your problem, check what formats the word processor supports.

I tried to append a figure to an EPS file, and received an error message.

You cannot append figures to an EPS file. The `-append` option is only valid for PostScript files, which should not be confused with EPS files. PostScript is a printer driver; EPS is a graphics file format.

Of the supported export formats, only HDF supports storing multiple figures, but you must use the `imwrite` function to append them. For an example, see the reference page for `imwrite`.

Size of Exported File

I've always used the EPS format to export my figures, but recently it started to generate huge files. Some of my files are now several megabytes!

Your graphics have probably become complicated enough that MATLAB is using the OpenGL or Z-buffer renderer instead of the Painter's renderer. It does this to improve display time or to handle attributes that Painter's cannot, such as lighting. However, using OpenGL or Z-buffer causes a bitmap to be stored in your EPS file, which sometimes leads to a large file.

There are two ways to fix the problem. You can specify the Painter's renderer when you export to EPS, or you can use a bitmap format, such as TIFF. The best renderer and type of format to use depend upon the figure. See "Bitmap or Vector Graphics" on page 7-66 if you need help deciding. For information about the rendering methods and how to set them, see "Selecting a Renderer" on page 7-48.

Making Movies

I am processing a large number of frames in MATLAB. I would like these frames to be saved as individual files for later conversion into a movie. How can I do this?

Use `getframe` to capture the frames, `imwrite` to write them to a file, and `movie` to create a movie from the files. For more information about using `getframe` and `imwrite` to capture and write the frames, see "Exporting with `getframe`" on page 7-24. For more information about creating a movie from the captured frames, see the reference page for `movie`.

You can also save multiple figures to an AVI file. AVI files can be used for animated sequences that do not need MATLAB to run. However, they do require an AVI viewer. For more information, see "Exporting Audio/Video Data" in the MATLAB Programming documentation.

Extended Operations

There are some export operations that cannot be performed using the Export dialog box.

You need to use the print function to do any of the following operations:

- Export to a supported file format not listed in the **Export** dialog box. The formats not available from the **Export** dialog box include HDF, some variations of BMP and PCX, and the raw data versions of PBM, PGM, and PPM.
- Specify a resolution.
- Specify one of the following options: TIFF preview, loose bounding box for EPS files, compression quality for JPEG files, CMYK output on Windows.
- Perform batch exporting.

General Problems

Background Color

When I output my figure, its background is changed to white. How can I get it to have the displayed background color?

By default, when you print or export a figure, MATLAB inverts the background color to white. There are two ways to retain the displayed background color: use the **Page Setup** dialog box or set the `InvertHardCopy` property to `off`. See “Setting the Background Color” on page 7-56 for instructions on either method.

If you are exporting your figure to the clipboard, you can also use the **Copy Options** panel of the **Preferences** dialog box. Setting the background here sets it for all figures copied to the clipboard.

Default Settings

I need to produce diagrams for publications. There is a list of requirements that I must meet for size of the figure, fonts types, etc. How can I do this easily and consistently?

You can set the default value for any property by adding a line to `startup.m`. As an example, the following line sets the default axes label font size to 12.

```
set(0, 'DefaultAxesFontSize', 12);
```

In your call to `set`, combine the word `Default` with the name of the object `Axes` and the property name `FontSize`.

Dimensions of Output

The dimensions of my output are huge. How can I make it smaller?

Check your settings for figure size and resolution, both of which affect the output dimensions of your figure.

The default figure size is 8-by-6 inches. You can use the **Page Setup** dialog box or the `PaperPosition` property to set the figure size. See “Setting the Figure Size and Position” on page 7-41.

The default resolution depends on the export format or printer driver used. For example, built-in MATLAB bitmap formats, like TIFF, have a default resolution of 150 dpi. You can change the resolution by using the `print` function and the `-r` switch. For default resolution values and instructions on how to change them, see “Setting the Resolution” on page 7-51.

I selected “Match Screen Size” from the Page Setup menu, but my output looks a little bigger, and my font looks different.

You probably output your figure using a higher resolution than your screen uses. Set your resolution to be the same as the screen’s.

As an alternative, if you are exporting your figure, see if your application enables you to select a resolution. If so, import the figure at the same resolution it was exported with. For more information about resolution and how to set it when exporting, see “Setting the Resolution” on page 7-51.

Axis and Tick Labels

When I resize my figure below a certain size, my x-axis label and the bottom half of the x-axis tick labels are missing from the output.

Your figure size might be too small to accommodate the labels. Labels are positioned a fixed distance from the x -axis. Since the x -axis itself is positioned a relative distance away from the window’s edge, the label text might not fit. Try using a larger figure size or smaller fonts. For instructions on setting the size of your figure, see “Setting the Figure Size and Position” on page 7-41. For information about setting font size, see the Text Properties reference page.

In my output, the x-axis has fewer ticks than it did on the screen.

MATLAB has rescaled your ticks because the size of your output figure is different from its displayed size. There are two ways to prevent this: select **Keep screen limits and ticks** from the **Axes and Figure** tab of the **Page Setup** dialog box, or set the `XTickMode`, `YTickMode`, and `ZTickMode` properties to manual. See “Setting the Axes Ticks and Limits” on page 7-54 for details.

UI Controls

My figure contains UI controls. How do I prevent them from appearing in my output?

Use the `print` function with the `-noui` switch. For details, see “Excluding User Interface Controls” on page 7-62.

Cropping

I can't output my figure using the uncropped setting (i.e., a loose `BoundingBox`).

Only PostScript printer drivers and the EPS export format support uncropped output. There is a workaround for Windows printer drivers, however. Using the `print` function, save your figure to a file that can be printed later. For an example see “Producing Uncropped Figures” on page 7-62.

Text Object Font

I have a problem with text objects when printing with a PostScript printer driver or exporting to EPS. The fonts are correct on the screen, but are changed in the output.

You have probably used a font that is not supported by EPS and PostScript. All unsupported fonts are converted to Courier. See “PostScript and Ghostscript Supported Fonts” on page 7-78 for the list of the supported fonts.

Handle Graphics Objects

Organization of Graphics Objects (p. 8-3)	Illustrates the graphics object hierarchy
Types of Graphics Objects (p. 8-4)	Describes the categories of graphics objects
Graphics Windows — the Figure (p. 8-5)	Overview of the MATLAB graphics window
Core Graphics Objects (p. 8-8)	Core objects used to create graphs and construct composite objects
Plot Objects (p. 8-17)	Composite objects that are used to create graphs
Annotation Objects (p. 8-22)	Create annotation object programmatically
Group Objects (p. 8-25)	Form groups of objects that behave as one object with respect to certain properties
Object Properties (p. 8-35)	Overview of object properties
Setting and Querying Property Values (p. 8-38)	How to set and query property values and how to return to original (factory default) values
Setting Default Property Values (p. 8-43)	How MATLAB determines what values to use for a given object's properties and how to define default values
Accessing Object Handles (p. 8-50)	Obtain the handles of existing objects
Controlling Graphics Output (p. 8-60)	Control target window for graphics output
Saving Handles in M-Files (p. 8-71)	How to manage object handles within a graphics M-file
Properties Changed by Built-In Functions (p. 8-72)	List of the properties that are changed by MATLAB built-in functions
Callback Properties for Graphics Objects (p. 8-84)	Object properties for which you can define callbacks

Objects That Can Contain Other
Objects (p. 8-75)

How to use figure and axes containers to write resize
functions

Function Handle Callbacks (p. 8-86)

How to use function handle callbacks

Example — Using Function Handles in
GUIs (p. 8-90)

Example showing how to write function handle callbacks

Organization of Graphics Objects

Graphics objects are the basic drawing elements used by MATLAB to display data. Each instance of an object is associated with a unique identifier called a *handle*. Using this handle, you can manipulate the characteristics (called object *properties*) of an existing graphics object. You can also specify values for properties when you create a graphics object.

These objects are organized into a hierarchy, as shown by the following diagram.

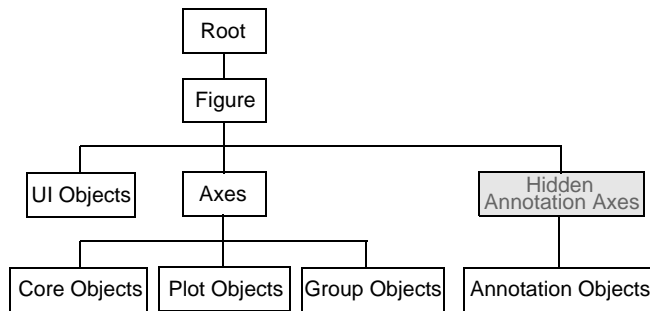

The hierarchical nature of Handle Graphics is based on the interdependencies of the various graphics objects. For example, to draw a line object, MATLAB needs an axes object to orient and provide a frame of reference to the line. The axes, in turn, needs a figure window to display the axes and its child objects.

Types of Graphics Objects

There are two basic types of graphics objects:

- Core graphics objects — Used by high-level plotting functions and by composite objects to create plot objects
- Composite objects — Composed of core graphics objects that have been grouped together to provide a more convenient interface

Composite objects form the basis for three subcategories of graphics objects.

- Plot objects — Composed of basic graphics objects, but enable properties to be set on plot object level
- Annotation objects — Exist on a layer separate from other graphics objects
- Group objects — Create groups of objects that can behave as one in certain respects. You can parent any axes child object to a group object, including other group object.
- UI objects — User interface objects are used to construct graphical user interfaces.

Graphics objects are interdependent, so the graphics display typically contains a variety of objects that, in conjunction, produce a meaningful graph or picture.

Information on Specific Graphics Objects

See the following sections for more information on the various types of graphics objects.

“Graphics Windows — the Figure” on page 8-5

“Core Graphics Objects” on page 8-8

“Plot Objects” on page 8-17

“Annotation Objects” on page 8-22

“Group Objects” on page 8-25

“Object Properties” on page 8-35

For information on user interface objects and their application, see the “Creating Graphical User Interfaces” documentation.

Graphics Windows — the Figure

Figures are the windows in which MATLAB displays graphics. Figures contain menus, toolbars, user-interface objects, context menus, axes and, as axes children, all other types of graphics objects.

MATLAB places no limits on the number of figures you can create (your computer systems might impose limitations, however).

Figures play two distinct roles in MATLAB:

- Containing data graphs
- Containing graphical user interfaces

Figures can contain both graphs and GUIs components at the same time. For example, a GUI might be designed to plot data and therefore contain an axes as well as user interface objects. See “Example — Using Figure Panels” on page 8-76 for an example of such a GUI.

The following diagram illustrates the types of objects that figures can contain.

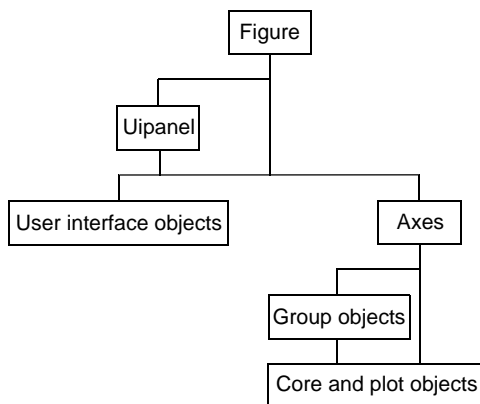

Note that both figures and axes have children that act as containers. A uipanel can contain user interface objects and be parented to a figure and group objects (hgggroup and hgtransform) can contain axes children and be parented to an axes.

See “Objects That Can Contain Other Objects” on page 8-75 for more information.

Figures Used for Graphing Data

MATLAB functions that draw graphics (e.g., `plot` and `surf`) create figures automatically if none exist. If there are multiple figures open, one figure is always designated as the “current” figure, and is the target for graphics output.

The `gcf` command returns the handle of the current figure or creates a new figure if one does not exist. For example, you can enter the following command to see a list of figure properties.

```
get(gcf)
```

The root object `CurrentFigure` property returns the handle of the current figure, if one exists, or returns empty if there are no figures open. For example,

```
get(0, 'CurrentFigure')
ans =
[]
```

See “Controlling Graphics Output” on page 8-60 for more information on how MATLAB determines where to display graphics.

Figure Children for Graphs

Figures that display graphs need to contain axes to provide the frame of reference for objects such as lines and surfaces, which are used to represent data. These data representing objects can be contained in group objects or contained directly in the axes. See “Example — Translating Grouped Objects” on page 8-81 for an example of how to use group objects.

Figures can contain multiple axes arranged in various locations within the figure and can be of various sizes. See “Automatic Axes Resize” on page 10-7 and “Multiple Axes per Figure” on page 10-13 for more information on axes.

Figures Used for GUIs

GUIs range from sophisticated applications to simple warning dialog boxes. You can modify many aspects of the figure to fit the intended use by setting figure properties. For example, the following figure properties are often useful when creating GUIs.

- Show or hide the figure menu, while displaying custom-designed menus (`MenuBar`)
- Change the figure title (`Name`)

- Control user access to the figure handle (`HandleVisibility`)
- Create a callback that executes whenever the user resizes the figure (`ResizeFcn`)
- Control display of the figure toolbar (`Toolbar`)
- Assign a context menu (`UIContextMenu`)
- Define callbacks that execute when users click drag or release the mouse over the figure (`WindowButtonDownFcn`, `WindowButtonMotionFcn`, `WindowButtonUpFcn`). Also see the `ButtonDownFcn` property.
- Specify whether the figure is modal (`WindowState`)

See the figure properties for more information on figure characteristics you can specify.

See the *Creating Graphical User Interfaces* documentation for more information about using figure to create GUIs.

Root Object — the Figure Parent

The parent of a figure is the root object. You cannot instantiate the root object because its purpose is only to store information. It maintains information on the state of MATLAB, your computer system, and some MATLAB defaults.

There is only one root object and all other objects are its descendants. You do not create the root object; it exists when you start MATLAB. You can, however, set the values of root properties and thereby affect the graphics display.

For more information see root object properties.

More Information on Figures

See the figure reference page for information on creating figures.

See “Callback Properties for Graphics Objects” on page 8-84 for information on figure events for which you can define callbacks.

See “Figure Properties” on page 9-1 for information on other figure properties.

Core Graphics Objects

Core graphics objects include basic drawing primitives like line, text, and polygon shells (patch objects); specialized objects like surfaces, which are composed of a rectangular grid of vertices; images; and light objects, which are not visible but affect the way some objects are colored.

Axes contain objects that represent data, such as line, surfaces, contour groups, etc.

The following table lists the core graphics objects and links to the reference pages of the functions used to create each object.

Core Graphics Objects

Function	Purpose
axes	Axes objects define the coordinate system for displaying graphs. Axes are always contained within a figure.
image	2-D representation of a matrix where numeric values are mapped to colors. Images can also be 3-D arrays of RGB values.
light	Directional light source located within the axes. Lights affect patches and surfaces, but cannot themselves be seen.
line	A line is drawn by connecting the data points that define it.
patch	Filled polygons with separate edge properties. A single patch can contain multiple faces, each colored independently with solid or interpolated colors.
rectangle	2-D object that has settable edge and face color, and variable curvature (can draw ellipses)

Core Graphics Objects

Function	Purpose
surface	3-D grid of quadrilaterals created by plotting the value of each element in a matrix as a height above the x - y plane
text	Character strings positioned in the coordinate system defined by the axes

The following picture illustrates some typical core graphics objects.

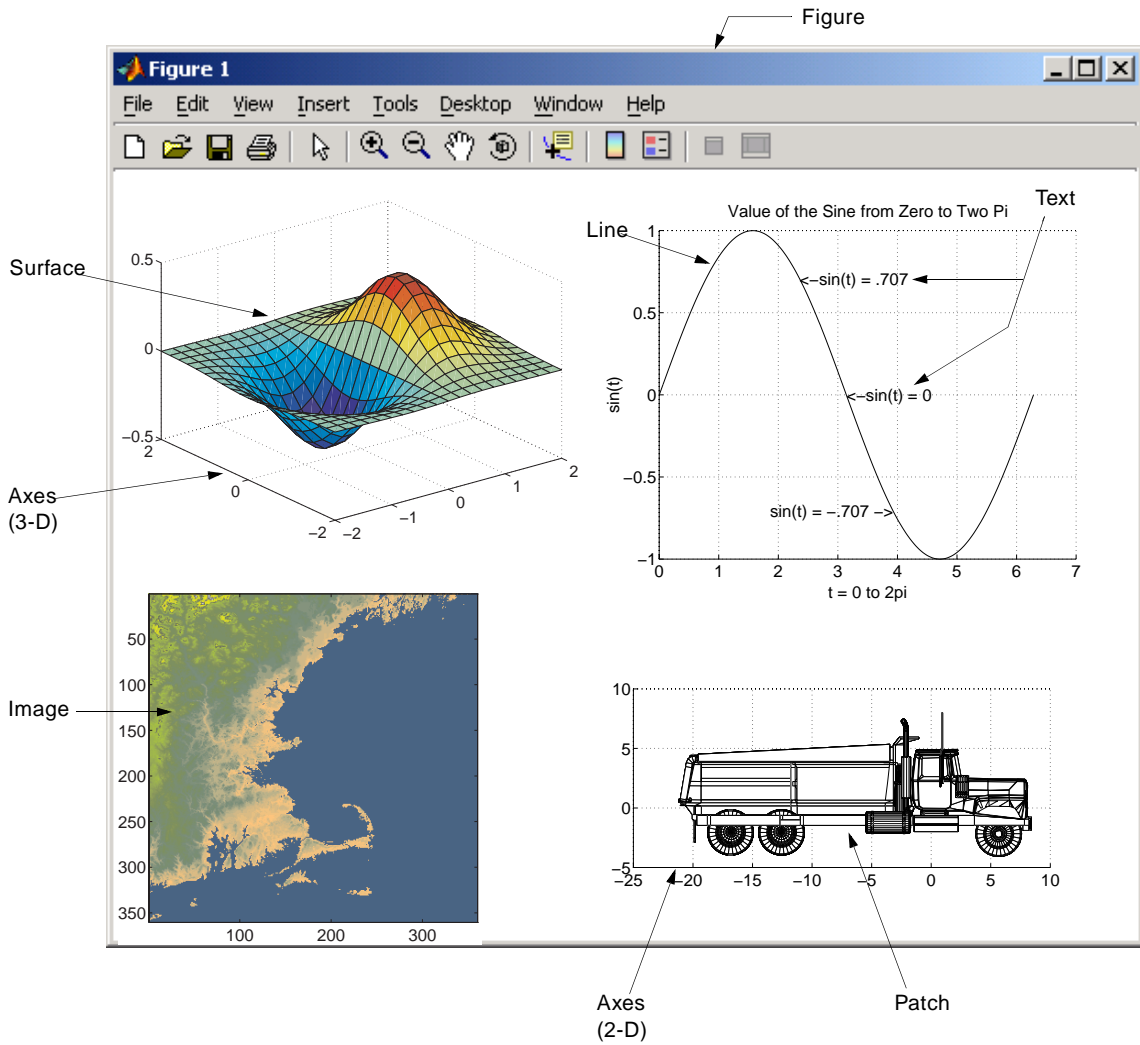

Description of Core Graphics Objects

This section describes the core graphics objects.

Axes

Axes objects define a frame of reference in a figure window for the display objects that are generally defined by data. For example, MATLAB creates a line by connecting each data point with a line segment. The axes determines the location of each data point in the figure by defining axis scales (x , y , and z or radius and angle, etc.)

Axes are children of figures and are parents of core, plot, and group objects.

Note that, while annotation objects are also children of axes, they can be parented only to the hidden annotation axes (see the `annotation` function for more information).

All functions that draw graphics (e.g., `plot`, `surf`, `mesh`, and `bar`) create an axes object if one does not exist. If there are multiple axes within the figure, one axes is always designated as the “current” axes, and is the target for display of the above-mentioned graphics objects (uicontrols and uimenu are not children of axes).

Image

A MATLAB image consists of a data matrix and possibly a colormap. There are three basic image types that differ in the way that data matrix elements are interpreted as pixel colors — indexed, intensity, and truecolor. Since images are strictly 2-D, you can view them only at the default 2-D view.

Light

Light objects define light sources that affect all patch and surface objects within the axes. You cannot see lights, but you can set properties that control the style of light source, color, location, and other properties common to all graphics objects.

Line

Line objects are the basic graphics primitives used to create most 2-D and some 3-D plots. High-level functions `plot`, `plot3`, and `loglog` (and others) create line objects. The coordinate system of the axes positions and orients the line.

Patch

Patch objects are filled polygons with edges. A single patch can contain multiple faces, each colored independently with solid or interpolated colors. `fill`, `fill3`, and `contour3` create patch objects. The coordinate system of the axes positions and orients the patch.

Rectangle

Rectangle objects are 2-D filled areas having a shape that can range from a rectangle to an ellipse. Rectangles are useful for creating flow-chart-type drawings.

Surface

Surface objects are 3-D representations of matrix data created by plotting the value of each matrix element as a height above the x - y plane. Surface plots are composed of quadrilaterals whose vertices are specified by the matrix data. MATLAB can draw surfaces with solid or interpolated colors or with only a mesh of lines connecting the points. The coordinate system of the axes positions and orients the surface.

The high-level function `pcolor` and the `surf` and `mesh` group of functions create surface objects.

Text

Text objects are character strings. The coordinate system of the parent axes positions the text. The high-level functions `title`, `xlabel`, `ylabel`, `zlabel`, and `gtext` create text objects.

Example – Creating Core Graphics Objects

Object creation functions have a syntax of the form

```
handle = function('propertyname',propertyvalue,...)
```

You can specify a value for any object property (except those that are read only) by passing property name/value pairs as arguments. The function returns the handle of the object it creates, which you can use to query and modify properties after creating the object.

This example evaluates a mathematical function and creates three graphics objects using the property values specified as arguments to the `figure`, `axes`, and `surface` commands. MATLAB uses default values for all other properties.

```
[x,y] = meshgrid([-2:.4:2]);
Z = x.*exp(-x.^2-y.^2);
fh = figure('Position',[350 275 400 300],'Color','w');
ah = axes('Color',[.8 .8 .8],'XTick',[-2 -1 0 1 2],...
         'YTick',[-2 -1 0 1 2]);
sh = surface('XData',x,'YData',y,'ZData',Z,...
            'FaceColor',get(ah,'Color')+1,...
            'EdgeColor','k','Marker','o',...
            'MarkerFaceColor',[.5 1 .85]);
```

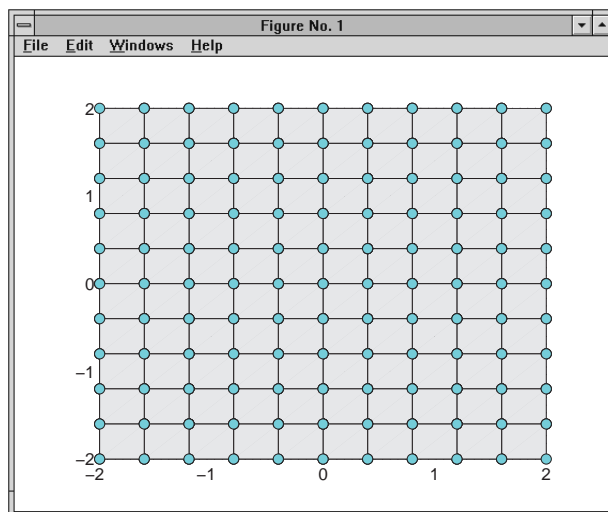

Note that the `surface` function does not use a 3-D view like the high-level `surf` functions. Object creation functions simply add new objects to the current axes without changing axes properties, except the `Children` property, which now includes the new object and the axis limits (`XLim`, `YLim`, and `ZLim`), if necessary.

You can change the view using the camera commands or use the `view` command.

```
view(3)
```

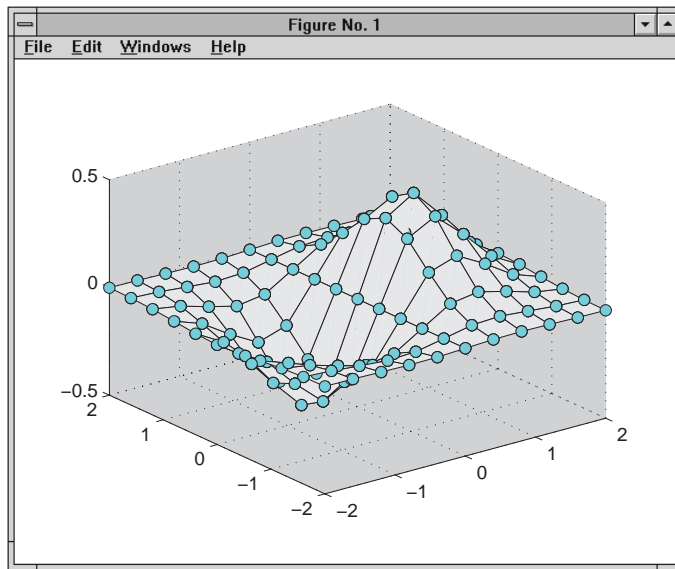

Parenting

By default, all statements that create graphics objects do so in the current figure and the current axes (if the object is an axes child). However, you can specify the parent of an object when you create it. For example, the statement

```
axes('Parent',figure_handle,...)
```

creates an axes in the figure identified by `figure_handle`. You can also move an object from one parent to another by redefining its `Parent` property.

```
set(gca,'Parent',figure_handle)
```

High-Level Versus Low-Level

Many MATLAB graphics functions call the object creation functions to draw graphics objects. However, high-level routines also clear the axes or create a new figure, depending on the settings of the axes and figure `NextPlot` properties.

In contrast, core object creation functions simply create their respective graphics objects and place them in the current parent object. They do not respect the settings of the figure or axes `NextPlot` property.

For example, if you call the `line` function,

```
line('XData',x,'YData',y,'ZData',z,'Color','r')
```

MATLAB draws a red line in the current axes using the specified data values. If there is no axes, MATLAB creates one. If there is no figure window in which to create the axes, MATLAB creates it as well.

If you call the `line` function a second time, MATLAB draws the second line in the current axes without erasing the first line. This behavior is different from high-level functions like `plot` that delete graphics objects and reset all axes properties (except `Position` and `Units`). You can change the behavior of high-level functions by using the `hold` command or by changing the setting of the axes `NextPlot` property.

See “Controlling Graphics Output” on page 8-60 for more information on this behavior and on using the `NextPlot` property.

Simplified Calling Syntax

Object creation functions have convenience forms that allow you to use a simpler syntax. For example,

```
text(.5,.5,.5,'Hello')
```

is equivalent to

```
text('Position',[.5 .5 .5],'String','Hello')
```

Note that using the convenience form of an object creation function can cause subtle differences in behavior when compared to formal property name/property value syntax.

A Note About Property Names

By convention, MATLAB documentation capitalizes the first letter of each word that makes up a property name, such as `LineStyle` or `XTickLabelMode`. While this makes property names easier to read, MATLAB does not check for uppercase letters. In addition, you need use only enough letters to identify the name uniquely, so you can abbreviate most property names.

In M-files, however, using the full property name can prevent problems with future releases of MATLAB if a shortened name is no longer unique because of the addition of new properties.

Plot Objects

A number of high-level plotting functions create plot objects. The properties of plot objects provide easy access to the important properties of the core graphics objects that the plot objects contain.

Plot object parents can be axes or group objects (hggroup or hgtransform). See “Objects That Can Contain Other Objects” on page 8-75 for examples.

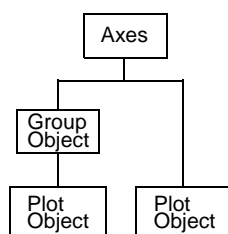

This table lists the plot objects and the graphing functions that use them. Click object names to see a description of their properties.

Plot Objects

Object	Purpose
areaseries	Used to create area graphs
barseries	Used to create bar graphs
contourgroup	Used to create contour graphs
errorbarseries	Used to create errorbar graphs
lineseries	Used by line plotting functions (plot, plot3, etc.)
quivergroup	Used to create quiver and quiver3 graphs
scattergroup	Used to create scatter and scatter3 graphs
stairseries	Used to create stairstep graphs (stairs)
stemseries	Used to create stem and stem3 graphs
surfaceplot	Used by the surf and mesh group of functions

Creating a Plot Object

For example, the following statements create a contour graph of the peaks function and then set the line style and width of the contour lines.

```
[x,y,z] = peaks;  
[c,h] = contour(x,y,z);  
set(h,'LineWidth',3,'LineStyle',':')
```

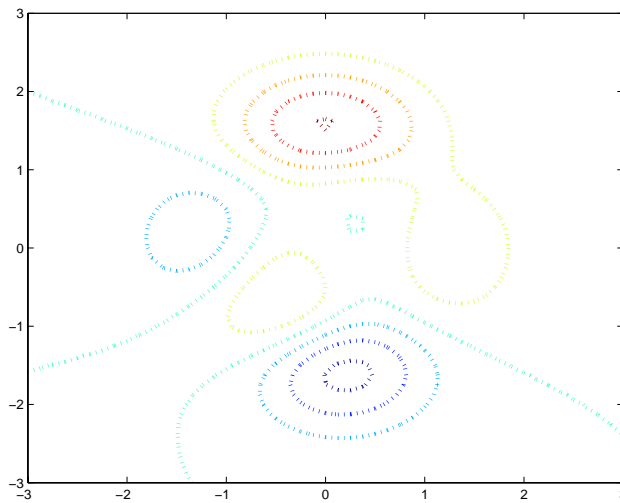

The contour plot object enables you to set the line width and style of the contour graph by setting two properties. Looking at the core objects contained in the contour plot object reveals a number of patch objects whose edges are used to implement the contour line, which you would otherwise need to set individually.

```
child_handles = get(h,'Children');  
get(child_handles,'Type')  
ans =  
    'patch'  
    'patch'  
    'patch'  
    'patch'
```



```
'patch'  
'patch'  
'patch'  
'patch'  
'patch'  
'patch'  
'patch'  
'patch'
```

Identifying Plot Objects Programmatically

Plot objects all return `hggroup` as the value of the `Type` property. If you want to be able to identify plot objects programmatically but do not have access to the object's handle, set a value for the object's `Tag` property.

For example, the following statements create a bar graph with five `barseries` objects and assign a different value for the `Tag` property on each object.

```
h = bar(rand(5));  
set(h, {'Tag'}, {'bar1', 'bar2', 'bar3', 'bar4', 'bar5'})
```

Note that the cell array of property values must be transposed (') to have the proper shape. See the `set` function for more information on setting properties.

No User Default Values

Note that you cannot define default values for plot objects.

Linking Graphs to Variables – Data Source Properties

Plot objects enable you to link a MATLAB expression with properties that contain data. For example, the `lineseries` object has data source properties associated with the `XData`, `YData`, and `ZData` properties. These properties are called `XDataSource`, `YDataSource`, and `ZDataSource`.

To use a data source property,

- 1 Assign the name of a variable to the data source property that you want linked to an expression.
- 2 Calculate a new value for the variable.

3 Call the `refreshdata` function to update the plot object data.

`refreshdata` enables you to specify whether to use a variable in the base workspace or the workspace of the function from which you call `refreshdata`.

Data Source Example

The following example illustrates how to use this technique.

```
function datasource_ex
t = 0:pi/20:2*pi;
y = exp(sin(t));
h = plot(t,y,'YDataSource','y');
for k = 1:1:10
    y = exp(sin(t.*k));
    refreshdata(h,'caller') % Evaluate y in the function workspace
    drawnow; pause(.1)
end
```

Changing the Size of Data Variables

If you change one data source property to a variable that contains data of a different dimension, you might cause the function to generate a warning and not render the graph until you have changed all data source properties to appropriate values.

Plot Objects and Backward Compatibility

Plotting functions that create plot objects can introduce incompatibilities with code written before MATLAB Version 7. However, all plotting functions that return handles to plot objects support an optional argument (`'v6'`) that forces the functions to use core objects, as was the case in MATLAB before Version 7.

See “Plot Objects” on page 8-17 for a list of functions that create plot objects.

See “Core Graphics Objects” on page 8-8 for a list of core graphics objects.

Saving Figures That Are Compatible with Previous Version of MATLAB

Create backward-compatible FIG-files by following these two steps.

- Ensure that any plotting functions used to create the contents of the figure are called with the `'v6'` argument, where applicable.

- Use the '-v6' option with the hgsave command.

For example,

```
h = figure;  
t = 0:pi/20:2*pi;  
plot('v6',t,sin(t).*2)  
hgsave(h,'myFigFile','-v6')
```

You can set a general MATLAB preference to ensure that figures saved by selecting the **Save** item under the figure **File** menu are backward compatible. To access MATLAB preferences, select **Preferences** from the Desktop **File** menu. Expand the **General** node and select **MAT Files**. Click **Ensure backward compatibility (-v6)**. Note that this setting affects all FIG-files and MAT-files that you create.

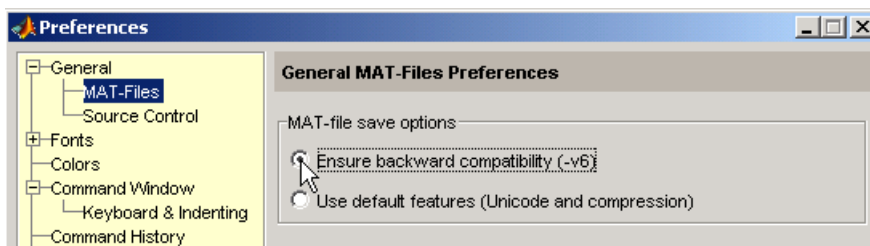

Annotation Objects

Users typically create annotation objects from the Plot Edit toolbar or the **Insert** menu (select **Plot Edit** in the **View** menu to display the Plot Edit toolbar). However, you can also create annotation objects using the `annotation` function.

Annotation objects are created in a hidden axes that extends the full width and height of the figure. This enables you to specify the locations of annotation objects anywhere in the figure using normalized coordinates (the lower left corner is the point 0,0, the upper right corner is the point 1,1).

Annotation Object Properties

Note You should not change any of the properties of the annotation axes or parent any graphics objects to this axes. Use the `annotation` function or the graphics tools to create annotation objects.

The following links access descriptions of the properties you can set on the respective annotation objects.

- [Annotation arrow properties](#)
- [Annotation doublearrow properties](#)
- [Annotation ellipse properties](#)
- [Annotation line properties](#)
- [Annotation rectangle properties](#)
- [Annotation textarrow properties](#)
- [Annotation textbox properties](#)

To modify the appearance of annotation objects created with the plotting tools, use the Property Editor.

Example – Enclosing Subplots with an Annotation Rectangle

The following example shows how to create a rectangle annotation object and use it to highlight two subplots in a figure. This example uses the axes

properties `Position` and `TightInset` to determine the location and size of the annotation rectangle.

- 1 First create an array of subplots.

```
x = -2*pi:pi/12:2*pi;
y = x.^2;
subplot(2,2,1:2)
plot(x,y)
h1=subplot(223);
y = x.^4;
plot(x,y)
h2=subplot(224);
y = x.^5;
plot(x,y)
```

- 2 Determine the location and size of the annotation rectangle required to enclose axes, tick mark labels, and title using the axes `Position` and `TightInset` properties.

```
p1 = get(h1, 'Position');
t1 = get(h1, 'TightInset');
p2 = get(h2, 'Position');
t2 = get(h2, 'TightInset');
x1 = p1(1)-t1(1); y1 = p1(2)-t1(2);
x2 = p2(1)-t2(1); y2 = p2(2)-t2(2);
w = x2-x1+t1(1)+p2(3)+t2(3); h = p2(4)+t2(2)+t2(4);
```

- 3 Create the annotation rectangle to enclose the lower two subplots. Make the rectangle a translucent red with a solid border.

```
annotation('rectangle',[x1,y1,w,h],...
'FaceAlpha',.2,'FaceColor','red','EdgeColor','red');
```

8 Handle Graphics Objects

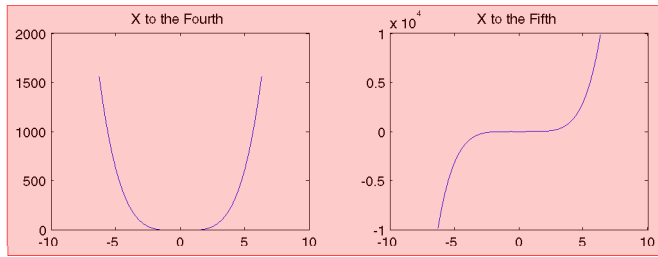
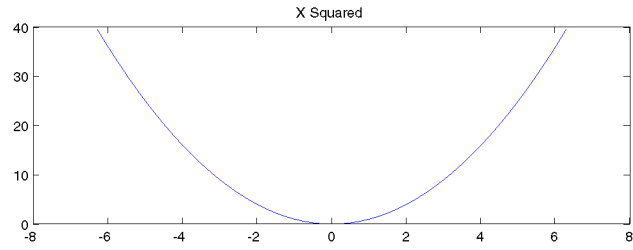

Group Objects

Group objects enable you to treat a number of axes child objects as one group. For example, you can make the entire group visible or invisible, select all objects when only one is clicked, or apply a transform matrix to reposition the objects by setting only one property on the group object.

There are two group objects:

- `hgggroup` — Use when you want to create a group of objects and control the visibility or selectability of the group based on what happens to any individual object in the group. Create `hgggroup` objects with the `hgggroup` function.
- `hgtransform` — Use when you want to transform a group of objects. Transforms include rotation, translation, scaling, etc. See “Example — Transforming a Hierarchy of Objects” for an example. Create `hgtransform` objects with the `hgtransform` function.

Note that the difference between the `hgggroup` and `hgtransform` objects is ability of the `hgtransform` object to apply a transform matrix (via its `Matrix` property) to all objects for which it is the parent.

Creating a Group

You create a group by parenting axes children to an `hgggroup` or `hgtransform` object. For example,

```
hb = bar(rand(5)); % creates 5 barseries objects
hg = hgggroup;
set(hb, 'Parent', hg) % parent the barseries to the hgggroup
set(hg, 'Visible', 'off') % makes all barseries invisible
```

Group objects can be the parent of any number of axes children, including other group objects.

Note Many plotting functions clear the axes (i.e., remove axes children) before drawing the graph. Clearing the axes also deletes any `hgggroup` or `hgtransform` objects in the axes.

Transforming Objects

The `hgtransform` object's `Matrix` property enables you to apply a transform to all the `hgtransform`'s children in unison. Typical transforms include rotation, translation, and scaling. You define a transform with a four-by-four transformation matrix, which is described in the following sections.

Creating a Transform Matrix

The `makehgtform` function simplifies the construction of matrices to perform rotation, translation, and scaling. See the “Example — Transforming a Hierarchy of Objects” section for information on creating transform matrices using `makehgtform`.

Rotation

Rotation transforms rotate objects about the x -, y -, or z -axis, with positive angles rotating counterclockwise while sighting along the respective axis toward the origin. If the desired angle of rotation is θ , the following matrices define this rotation about the respective axis.

X-axis rotation	Y-axis rotation	Z-axis rotation
$\begin{bmatrix} 1 & 0 & 0 & 0 \\ 0 & \cos\theta_x & -\sin\theta_x & 0 \\ 0 & \sin\theta_x & \cos\theta_x & 0 \\ 0 & 0 & 0 & 1 \end{bmatrix}$	$\begin{bmatrix} \cos\theta_y & 0 & \sin\theta_y & 0 \\ 0 & 1 & 0 & 0 \\ -\sin\theta_y & 0 & \cos\theta_y & 0 \\ 0 & 0 & 0 & 1 \end{bmatrix}$	$\begin{bmatrix} \cos\theta_z & -\sin\theta_z & 0 & 0 \\ \sin\theta_z & \cos\theta_z & 0 & 0 \\ 0 & 0 & 1 & 0 \\ 0 & 0 & 0 & 1 \end{bmatrix}$

To create a transform matrix for rotation about an arbitrary axis, use the `makehgtform` function.

Translation

Translation transforms move objects with respect to their current locations. Specify the translation as distances t_x , t_y , and t_z in data space units. The following matrix shows the location of these elements in the transform matrix.

$$\begin{bmatrix} 1 & 0 & 0 & t_x \\ 0 & 1 & 0 & t_y \\ 0 & 0 & 1 & t_z \\ 0 & 0 & 0 & 1 \end{bmatrix}$$

Scaling

Scaling transforms change the sizes of objects. Specify scale factors s_x , s_y , and s_z and construct the following matrix.

$$\begin{bmatrix} s_x & 0 & 0 & 0 \\ 0 & s_y & 0 & 0 \\ 0 & 0 & s_z & 0 \\ 0 & 0 & 0 & 1 \end{bmatrix}$$

The Default Transform

The default transform is the identity matrix, which you can create with the eye function. Here is the identity matrix:

$$\begin{bmatrix} 1 & 0 & 0 & 0 \\ 0 & 1 & 0 & 0 \\ 0 & 0 & 1 & 0 \\ 0 & 0 & 0 & 1 \end{bmatrix}$$

See “Undoing Transform Operations” for related information.

Absolute vs. Relative Transforms

Transforms are specified in absolute terms, not relative to the current transform. For example, if you apply a transform that translates the hgtransform object 5 units in the x direction and then you apply another

transform that translates it 4 units in the y direction, the resulting position of the object is 4 units in the y direction from its original position.

If you want transforms to accumulate, you must concatenate the individual transforms into a single matrix. See “Combining Transforms into One Matrix” for more information.

Combining Transforms into One Matrix

It is usually more efficient to combine various transform operations into one matrix by concatenating (multiplying) the individual matrices and setting the `Matrix` property to the result. Note that matrix multiplication is not commutative, so the order in which you multiply the matrices affects the result. For example, suppose you want to perform an operation that scales, translates, and then rotates. You would multiply the matrices as follows:

```
C = R*T*S % operations are performed from right to left
```

where S is the scaling matrix, T is the translation matrix, R is the rotation matrix, and C is the composite of the three operations. You then set the `hgtransform` object’s `Matrix` property to C :

```
set(hgtransform_handle, 'Matrix', C)
```

Note that the following sets of statements are not equivalent:

```
set(hgtransform_handle, 'Matrix', C) % Transform as above  
set(hgtransform_handle, 'Matrix', eye(4) ) % Undo transform
```

versus

```
C = eye(4)*R*T*S % Multiply identity matrix as last step  
set(hgtransform_handle, 'Matrix', C)
```

Concatenating the identity matrix to other matrices has no effect on the composite matrix.

Undoing Transform Operations

Since transform operations are specified in absolute terms (not relative to the current transform), you can undo a series of transforms by setting the current transform to the identity matrix. For example, the following statement

```
set(hgtransform_handle, 'Matrix', eye(4) )
```

returns the object *hgtransform_handle* to its untransformed orientation.

Rotations Away From the Origin

Since rotations are performed about the origin, it is often necessary to translate the *hgtransform* object so that the desired axis of rotation is temporarily at the origin. After applying the rotation transform matrix, you then translate the *hgtransform* object back to its original position. The following example illustrates how to do this.

Suppose you want to rotate a surface about the *y*-axis at the center of the surface (the *y*-axis that passes through the point $x = 20$ in this example).

Note If you are using the MATLAB Help browser, you can run this example or open it in the MATLAB editor.

1 Create a surface and an *hgtransform* object. Parent the surface to the *hgtransform* object.

```
h = surf(peaks(40)); view(-20,30)
t = hgtransform;
set(h, 'Parent', t)
```

The following picture shows the surface.

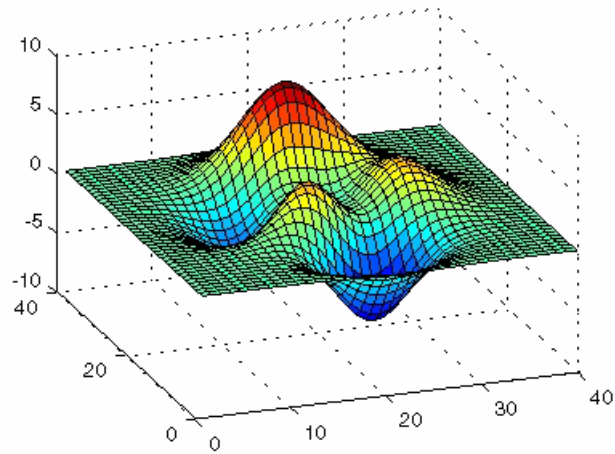

- 2** Create and set a y-axis rotation matrix to rotate the surface by -15 degrees.

```
ry_angle = -15*pi/180; % Convert to radians  
Ry = makehgtform('yrotate',ry_angle);  
set(t,'Matrix',Ry)
```

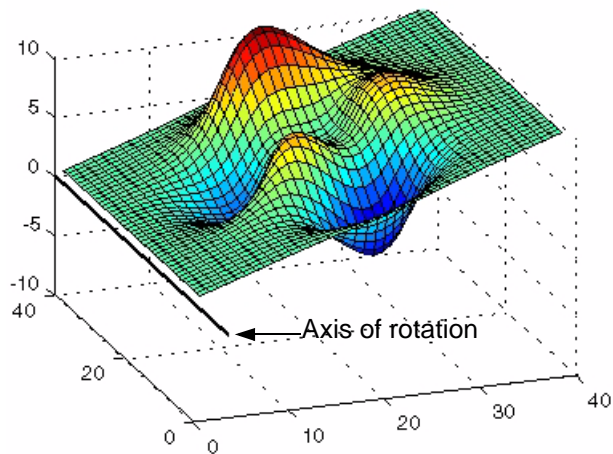

Notice that the surface rotated -15 degrees about the y -axis that passes through the origin. However, to rotate about the y -axis that passes through the point $x = 20$, you must translate the surface in x by 20 units.

- 3** Create two translation matrices, one to translate the surface -20 units in x and another to translate 20 units back. Concatenate the two translation matrices with the rotation matrix in the correct order and set the transform.

```
Tx1 = makehgtform('translate',[-20 0 0]);
Tx2 = makehgtform('translate',[20 0 0]);
set(t,'Matrix',Tx2*Ry*Tx1)
```

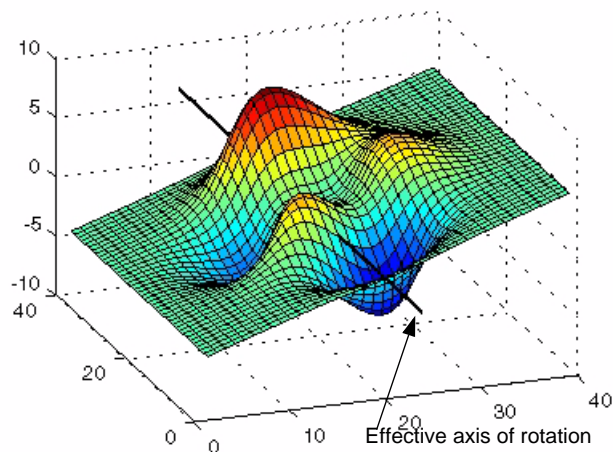

Example – Transforming a Hierarchy of Objects

This example creates a hierarchy of hgtransform objects, which are then transformed in sequence to create a cube from six squares. The example illustrates how you can parent hgtransform objects to other hgtransform objects to create a hierarchy and how transforming members of a hierarchy affects subordinate members.

The following picture illustrates the hierarchy.

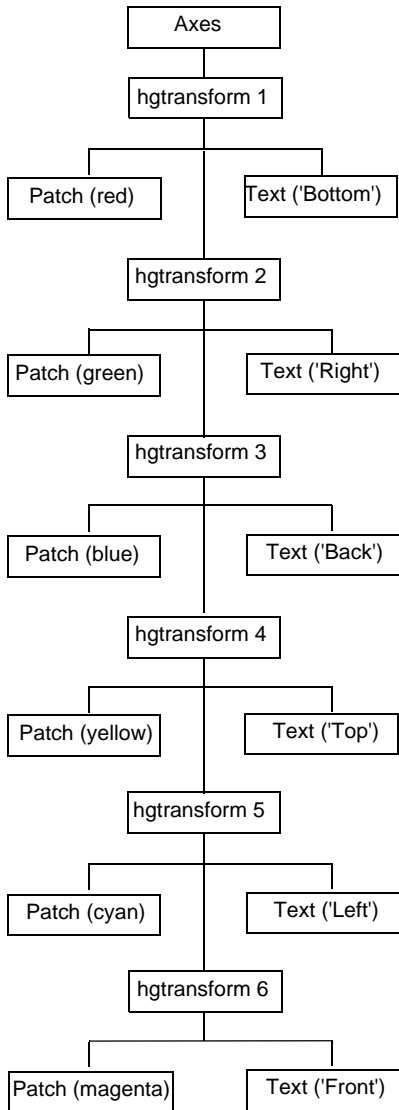

The diagram on the left represents the object hierarchy in the picture below.

Through a series of simple rotations and translations, the six squares are folded into a cube.

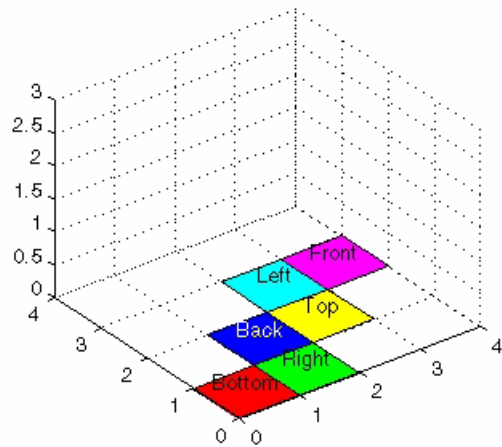

Note If you are using the MATLAB Help browser, you can run this example or open it in the MATLAB editor.

- 1 Set up the figure and the view. Use double buffering to prevent flashing during the loop. Set the `Renderer` property to `zbuffer`.

```
set(gcf, 'DoubleBuffer', 'on');  
set(gcf, 'Renderer', 'zbuffer');
```

```
% Set axis limits and view
```

```
set(gca, 'XLim', [0 4], 'YLim', [0 4], 'ZLim', [0 3]);  
view(3); axis equal; grid on
```

- 2 Define a hierarchy of `hgtransform` objects.

```
t(1) = hgtransform;  
t(2) = hgtransform('parent', t(1));  
t(3) = hgtransform('parent', t(2));  
t(4) = hgtransform('parent', t(3));  
t(5) = hgtransform('parent', t(4));  
t(6) = hgtransform('parent', t(5));
```

- 3 Create the patch and text objects and parent each pair to the respective `hgtransform` object.

Note that the data defining each patch object and the locations of all text objects are the same and are assigned by a single call to `set`. The objects are then translated to the desired positions on screen.

```
% Patch data
```

```
X = [0 0 1 1];  
Y = [0 1 1 0];  
Z = [0 0 0 0];
```

```
% Text data
```

```
Xtext = .5;  
Ytext = .5;  
Ztext = .15;
```

```
% Parent corresponding pairs of objects (patch and text)  
% into the object hierarchy
```

```
p(1) = patch('FaceColor', 'red', 'Parent', t(1));
```

```
txt(1) = text('String','Bottom','Parent',t(1));
p(2) = patch('FaceColor','green','Parent',t(2));
txt(2) = text('String','Right','Parent',t(2));
p(3) = patch('FaceColor','blue','Parent',t(3));
txt(3) = text('String','Back','Color','white','Parent',t(3));
p(4) = patch('FaceColor','yellow','Parent',t(4));
txt(4) = text('String','Top','Parent',t(4));
p(5) = patch('FaceColor','cyan','Parent',t(5));
txt(5) = text('String','Left','Parent',t(5));
p(6) = patch('FaceColor','magenta','Parent',t(6));
txt(6) = text('String','Front','Parent',t(6));

% Set the patch x, y, and z data
set(p,'XData',X,'YData',Y,'ZData',Z)

% Set the position and alignment of the text
set(txt,'Position',[Xtext Ytext Ztext],...
      'HorizontalAlignment','center',...
      'VerticalAlignment','middle')
```

- 4** Translate the squares (patch objects) to the desired locations. Note that as hgtransform object 2 is translated, all its children (including hgtransform objects 3 through 6) are also translated. Therefore, each translation requires moving the square by only one unit in either the x or y direction. Hgtransform object 1 is left at its original position.

```
% Set up initial translation transform matrices
% Translate 1 unit in x
Tx = makehgtform('translate',[1 0 0]);
% Translate 1 unit in y
Ty = makehgtform('translate',[0 1 0]);

% Set the Matrix property of each hgtransform object (2-6)
set(t(2),'Matrix',Tx);
drawnow
set(t(3),'Matrix',Ty);
drawnow
set(t(4),'Matrix',Tx);
drawnow
set(t(5),'Matrix',Ty);
drawnow
set(t(6),'Matrix',Tx);
```

Object Properties

A graphics object's properties control many aspects of its appearance and behavior. Properties include general information such as the object's type, its parent and children, and whether it is visible, as well as information unique to the particular class of object.

For example, from any given figure object you can obtain the identity of the last key pressed in the window, the location of the pointer, or the handle of the most recently selected menu.

Note The simplest way to access the documentation of all object properties is using the Handle Graphics Property Browser.

Storing Object Information

MATLAB organizes graphics information into a hierarchy and stores information about objects in properties. For example, root properties contain the handle of the current figure and the current location of the pointer (cursor), figure properties maintain lists of their descendants and keep track of certain events that occur within the window, and axes properties contain information about how each child object uses the figure colormap and the color order used by the `plot` function.

Changing Values

You can query the current value of any property and specify most property values (although some are set by MATLAB and are read only). Property values apply uniquely to a particular instance of an object; setting a value for one object does not change this value for other objects of the same type.

Default Values

You can set default values that affect all subsequently created objects. Whenever you do not define a value for a property, either as a default or when you create the object, MATLAB uses “factory-defined” values.

Note that plot objects do not allow you to set default values.

The reference entry for each object creation function provides a complete list of the properties associated with the graphics object.

Properties Common to All Objects

Some properties are common to all graphics objects, as illustrated in the following table.

Property	Description
BeingDeleted	Has a value of on when object's DeleteFcn has been called
BusyAction	Controls the way MATLAB handles callback routine interruption defined for the particular object
ButtonDownFcn	Callback routine that executes when button press occurs
Children	Handles of all this object's child objects
Clipping	Mode that enables or disables clipping (meaningful only for axes children)
CreateFcn	Callback routine that executes when this type of object is created
DeleteFcn	Callback routine that executes when you issue a command that destroys the object
HandleVisibility	Allows you to control the availability of the object's handle from the command line and from within callback routines
HitTest	Determines if object can become the current object when selected by a mouse click
Interruptible	Determines whether a callback routine can be interrupted by a subsequently invoked callback routine

Property	Description
Parent	The object's parent
Selected	Indicates whether object is selected
SelectionHighlight	Specifies whether object visually indicates the selection state
Tag	User-specified object label
Type	The type of object (figure, line, text, etc.)
UserData	Any data you want to associate with the object
Visible	Determines whether or not the object is visible

Setting and Querying Property Values

The `set` and `get` functions specify and retrieve the value of existing graphics object properties. They also enable you to list possible values for properties that have a fixed set of values. (You can also use the Property Editor to set many property values.)

The basic syntax for setting the value of a property on an existing object is

```
set(object_handle, 'PropertyName', 'NewPropertyValue')
```

To query the current value of a specific object's property, use a statement like

```
returned_value = get(object_handle, 'PropertyName');
```

Property names are always quoted strings. Property values depend on the particular property.

See “Accessing Object Handles” on page 8-50 and the `findobj` command for information on finding the handles of existing objects.

Setting Property Values

You can change the properties of an existing object using the `set` function and the handle returned by the creating function. For example, this statement moves the *y*-axis to the right side of the plot on the current axes.

```
set(gca, 'YAxisLocation', 'right')
```

If the handle argument is a vector, MATLAB sets the specified value on all identified objects.

You can specify property names and property values using structure arrays or cell arrays. This can be useful if you want to set the same properties on a number of objects. For example, you can define a structure to set axes properties appropriately to display a particular graph.

```
view1.CameraViewAngleMode = 'manual';  
view1.DataAspectRatio = [1 1 1];  
view1.ProjectionType = 'Perspective';
```

To set these values on the current axes, type

```
set(gca, view1)
```

Listing Possible Values

You can use `set` to display the possible values for many properties without actually assigning a new value. For example, this statement obtains the values you can specify for line object markers.

```
set(obj_handle, 'Marker')
```

MATLAB returns a list of values for the Marker property for the type of object specified by `obj_handle`. Braces indicate the default value.

```
[ + | o | * | . | x | square | diamond | v | ^ | > | < | pentagram
| hexagram | {none} ]
```

To see a list of all settable properties along with possible values of properties that accept string values, use `set` with just an object handle.

```
set(object_handle)
```

For example, for a surface object, MATLAB returns

```
CData
CDataScaling: [ {on} | off]
EdgeColor: [ none | {flat} | interp ] ColorSpec.
EraseMode: [ {normal} | background | xor | none ]
FaceColor: [ none | {flat} | interp | texturemap ] ColorSpec.
LineStyle: [ {-} | — | : | -. | none ]
.
.
.
Visible: [ {on} | off ]
```

If you assign the output of the `set` function to a variable, MATLAB returns the output as a structure array. For example,

```
a = set(gca);
```

The field names in `a` are the object's property names and the field values are the possible values for the associated property. For example,

```
a.GridLineStyle
ans =
    '-'
    '- -'
```

```
' : '  
' - . '  
' none '
```

returns the possible values for the axes grid line styles. Note that while property names are not case sensitive, MATLAB structure field names are. For example,

```
a.gridlinestyle  
??? Reference to non-existent field 'gridlinestyle'.
```

returns an error.

Querying Property Values

Use `get` to query the current value of a property or of all the object's properties. For example, check the value of the current axes `PlotBoxAspectRatio` property.

```
get(gca, 'PlotBoxAspectRatio')  
  
ans =  
     1     1     1
```

MATLAB lists the values of all properties, where practical. However, for properties containing data, MATLAB lists the dimensions only (for example, `CurrentPoint` and `ColorOrder`).

```
AmbientLightColor = [1 1 1]  
Box = off  
CameraPosition = [0.5 0.5 2.23205]  
CameraPositionMode = auto  
CameraTarget = [0.5 0.5 0.5]  
CameraTargetMode = auto  
CameraUpVector = [0 1 0]  
CameraUpVectorMode = auto  
CameraViewAngle = [32.2042]  
CameraViewAngleMode = auto  
CLim: [0 1]  
CLimMode: auto  
Color: [0 0 0]  
CurrentPoint: [ 2x3 double]  
ColorOrder: [ 7x3 double]
```

```

    .
    .
    .
    Visible = on

```

Querying Individual Properties

You can obtain the data from the property by getting that property individually.

```

get(gca, 'ColorOrder')
ans =
     0         0     1.0000
     0     0.5000         0
    1.0000         0         0
     0     0.7500     0.7500
    0.7500         0     0.7500
    0.7500     0.7500         0
    0.2500     0.2500     0.2500

```

Returning a Structure

If you assign the output of `get` to a variable, MATLAB creates a structure array whose field names are the object property names and whose field values are the current values of the named property.

For example, if you plot some data, `x` and `y`,

```
h = plot(x,y);
```

and get the properties of the line object created by `plot`,

```
a = get(h);
```

you can access the values of the line properties using the field name. This call to the `text` command places the string 'x and y data' at the first data point and colors the text to match the line color.

```
text(x(1),y(1),'x and y data','Color',a.Color)
```

If `x` and `y` are matrices, `plot` draws one line per column. To label the plot of the second column of data, reference that line.

```
text(x(1,2),y(1,2),'Second set of data','Color',a(2).Color)
```

Querying Groups of Properties

You can define a cell array of property names and conveniently use it to obtain the values for those properties. For example, suppose you want to query the values of the axes “camera mode” properties. First define the cell array.

```
camera_props(1) = {'CameraPositionMode'};  
camera_props(2) = {'CameraTargetMode'};  
camera_props(3) = {'CameraUpVectorMode'};  
camera_props(4) = {'CameraViewAngleMode'};
```

Use this cell array as an argument to obtain the current values of these properties.

```
get(gca,camera_props)  
ans =  
    'auto' 'auto' 'auto' 'auto'
```

Factory-Defined Property Values

MATLAB defines values for all properties, which are used if you do not specify values as arguments or as defaults. You can obtain a list of all factory-defined values with the statement

```
a = get(0,'Factory');
```

`get` returns a structure array whose field names are the object type and property name concatenated, and field values are the factory value for the indicated object and property. For example, this field,

```
UimenuSelectionHighlight: 'on'
```

indicates that the factory value for the `SelectionHighlight` property on `uimenu` objects is `on`.

You can get the factory value of an individual property with

```
get(0,'FactoryObjectTypePropertyName')
```

For example,

```
get(0,'FactoryTextFontName')
```

Setting Default Property Values

All object properties have values built into MATLAB (i.e., factory-defined values). You can also define your own default values at any point in the object hierarchy.

Note that you cannot define default values for plot objects.

How MATLAB Searches for Default Values

MATLAB searches for a default value beginning with the current object and continuing through the object's ancestors until it finds a user-defined default value or until it reaches the factory-defined value. Therefore, a search for property values is always satisfied.

The closer to the root of the hierarchy you define the default, the broader its scope. If you specify a default value for line objects on the root level, MATLAB uses that value for all lines (because the root is at the top of the hierarchy). If you specify a default value for line objects on the axes level, then MATLAB uses that value for line objects drawn only in that axes.

If you define default values on more than one level, the value defined on the closest ancestor takes precedence because MATLAB terminates the search as soon as it finds a value.

Note that setting default values affects only those objects created after you set the default. Existing graphics objects are not affected.

This diagram shows the steps MATLAB follows in determining the value of a graphics object property.

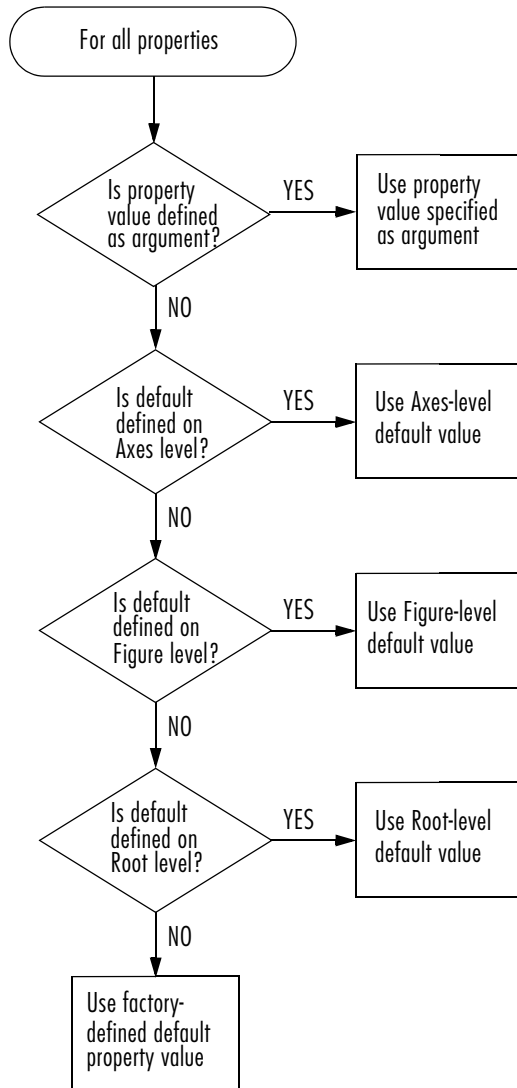

Defining Default Values

To specify default values, create a string beginning with the word `Default` followed by the object type and finally the object property. For example, to specify a default value of 1.5 points for the line property `LineWidth` at the level of the current figure, use the statement

```
set(gcf, 'DefaultLineLineWidth', 1.5)
```

The string `DefaultLineLineWidth` identifies the property as a line property. To specify the figure color, use `DefaultFigureColor`. Note that it is meaningful to specify a default figure color only on the root level.

```
set(0, 'DefaultFigureColor', 'b')
```

Use `get` to determine what default values are currently set on any given object level; for example,

```
get(gcf, 'default')
```

returns all default values set on the current figure.

Setting Properties to the Default

Specifying a property value of `'default'` sets the property to the first encountered default value defined for that property. For example, these statements result in a green surface `EdgeColor`:

```
set(0, 'DefaultSurfaceEdgeColor', 'k')
h = surface(peaks);
set(gcf, 'DefaultSurfaceEdgeColor', 'g')
set(h, 'EdgeColor', 'default')
```

Because a default value for surface `EdgeColor` exists on the figure level, MATLAB encounters this value first and uses it instead of the default `EdgeColor` defined on the root.

Removing Default Values

Specifying a property value of `'remove'` gets rid of user-defined default values. The statement

```
set(0, 'DefaultSurfaceEdgeColor', 'remove')
```

removes the definition of the default `Surface EdgeColor` from the root.

Setting Properties to Factory-Defined Values

Specifying a property value of 'factory' sets the property to its factory-defined value. (The property descriptions provides access to the factory settings for properties having predefined sets of values.)

For example, these statements set the `EdgeColor` of surface `h` to black (its factory setting) regardless of what default values you have defined.

```
set(gcf, 'DefaultSurfaceEdgeColor', 'g')
h = surface(peaks);
set(h, 'EdgeColor', 'factory')
```

Reserved Words

Setting a property value to `default`, `remove`, or `factory` produces the effects described in the previous sections. To set a property to one of these words (e.g., a text or `uicontrol` `String` property set to the word `Default`), you must precede the word with the backslash character. For example,

```
h = uicontrol('Style', 'edit', 'String', '\\Default');
```

Examples – Setting Default Line Styles

The `plot` function cycles through the colors defined by the axes `ColorOrder` property when displaying multiline plots. If you define more than one value for the axes `LineStyleOrder` property, MATLAB increments the line style after each cycle through the colors.

You can set default property values that cause the `plot` function to produce graphs using varying linestyles, but not varying colors. This is useful when you are working on a monochrome display or printing on a black and white printer.

First Example

This example creates a figure with a white plot (axes) background color, then sets default values for axes objects on the root level.

```
whitebg('w') %create a figure with a white color scheme
set(0, 'DefaultAxesColorOrder', [0 0 0], ...
      'DefaultAxesLineStyleOrder', '-|--|:-.')

```

Whenever you call `plot`,

```
Z = peaks; plot(1:49, Z(4:7,:))
```

it uses one color for all data plotted because the axes `ColorOrder` contains only one color, but cycles through the linestyles defined for `LineStyleOrder`.

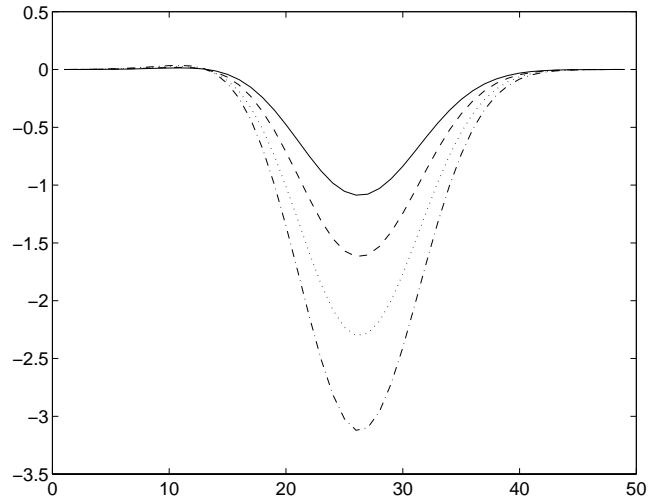

Second Example

This example sets default values on more than one level in the hierarchy. These statements create two axes in one figure window, setting default values on the figure level and the axes level.

```
t = 0:pi/20:2*pi;
s = sin(t);
c = cos(t);
% Set default value for axes Color property
figh = figure('Position',[30 100 800 350],...
             'DefaultAxesColor',[.8 .8 .8]);

axh1 = subplot(1,2,1); grid on
% Set default value for line LineStyle property in first axes
set(axh1,'DefaultLineStyle',' .')
line('XData',t,'YData',s)
line('XData',t,'YData',c)
text('Position',[3 .4],'String','Sine')
text('Position',[2 .3],'String','Cosine',...
```

```

        'HorizontalAlignment','right')

axh2 = subplot(1,2,2); grid on
% Set default value for text Rotation property in second axes
set(axh2,'DefaultTextRotation',90)
line('XData',t,'YData',s)
line('XData',t,'YData',c)
text('Position',[3 .4],'String','Sine')
text('Position',[2 .3],'String','Cosine',...
     'HorizontalAlignment','right')

```

Issuing the same line and text statements to each subplot region results in a different display, reflecting different default settings.

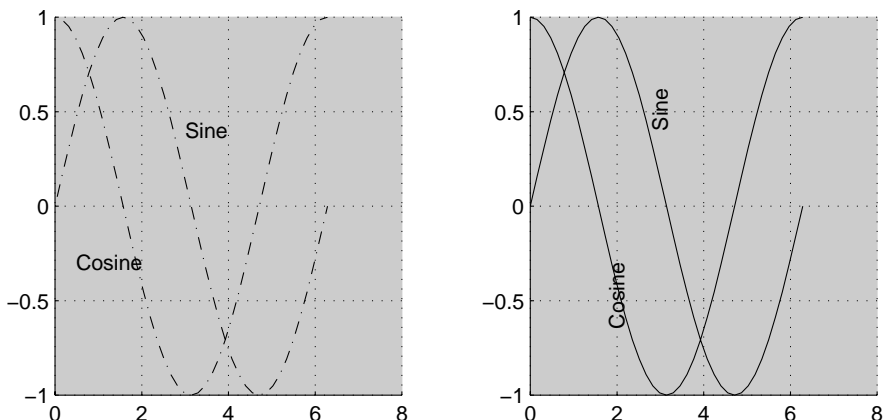

Because the default axes Color property is set on the figure level of the hierarchy, MATLAB creates both axes with the specified gray background color.

The axes on the left (subplot region 121) defines a dash-dot line style (–.) as the default, so each call to the `line` function uses dash-dot lines. The axes on the right does not define a default line style, so MATLAB uses solid lines (the factory setting for lines).

The axes on the right defines a default text Rotation of 90 degrees, which rotates all text by this amount. MATLAB obtains all other property values from their factory settings, which results in nonrotated text on the left.

To install default values whenever you run MATLAB, specify them in your `startup.m` file. Note that MATLAB might install default values for some appearance properties when started by calling the `colordef` command.

Accessing Object Handles

MATLAB assigns a handle to every graphics object it creates. All object creation functions optionally return the handle of the created object. If you want to access the object's properties (e.g., from an M-file) you should assign its handle to a variable at creation time to avoid searching for it later. However, you can always obtain the handle of an existing object with the `findobj` function or by listing its parent's `Children` property. See "Protecting Figures and Axes" on page 8-66 for more information on how object handles are hidden from normal access.

The root object's handle is always zero. The handle of a figure is either

- An integer that, by default, is displayed in the window title bar
- A floating point number requiring full MATLAB internal precision

The figure `IntegerHandle` property controls the type of handle the figure receives.

All other graphics object handles are floating-point numbers. You must maintain the full precision of these numbers when you reference handles. Rather than attempting to read handles off the screen and retype them, you must store the value in a variable and pass that variable whenever MATLAB requires a handle.

The Current Figure, Axes, and Object

An important concept in Handle Graphics is that of being current. The current figure is the window designated to receive graphics output. Likewise, the current axes is the target for commands that create axes children. The current object is the last graphics object created or clicked on by the mouse.

MATLAB stores the three handles corresponding to these objects in the ancestor's property list.

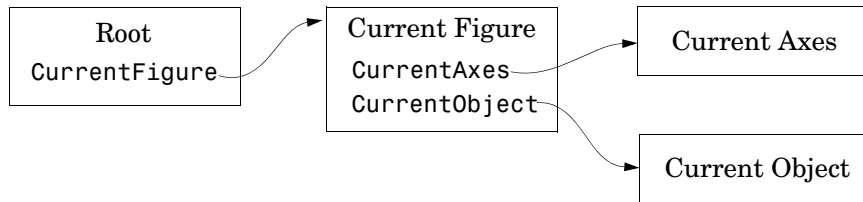

These properties enable you to obtain the handles of these key objects.

```

get(0, 'CurrentFigure');
get(gcf, 'CurrentAxes');
get(gcf, 'CurrentObject');
  
```

The following commands are shorthand notation for the get statements.

- `gcf` — Returns the value of the root `CurrentFigure` property
- `gca` — Returns the value of the current figure's `CurrentAxes` property
- `gco` — Returns the value of the current figure's `CurrentObject` property

You can use these commands as input arguments to functions that require object handles. For example, you can click on a line object and then use `gco` to specify the handle to the `set` command,

```
set(gco, 'Marker', 'square')
```

or list the values of all current axes properties with

```
get(gca)
```

You can get the handles of all the graphic objects in the current axes (except those with hidden handles),

```
h = get(gca, 'Children');
```

and then determine the types of the objects.

```

get(h, 'type')
ans =
    'text'
    'patch'
    'surface'
    'line'
  
```

While `gcf` and `gca` provide a simple means of obtaining the current figure and axes handles, they are less useful in M-files. This is particularly true if your M-file is part of an application layered on MATLAB where you do not necessarily have knowledge of user actions that can change these values.

See “Controlling Graphics Output” on page 8-60 for information on how to prevent users from accessing the handles of graphics objects that you want to protect.

Searching for Objects by Property Values – `findobj`

The `findobj` function provides a means to traverse the object hierarchy quickly and obtain the handles of objects having specific property values. If you do not specify a starting object, `findobj` searches from the root object, finding all occurrences of the property name/property value combination you specify.

Example – Finding Objects

This plot of the sine function contains text objects labeling particular values of the function.

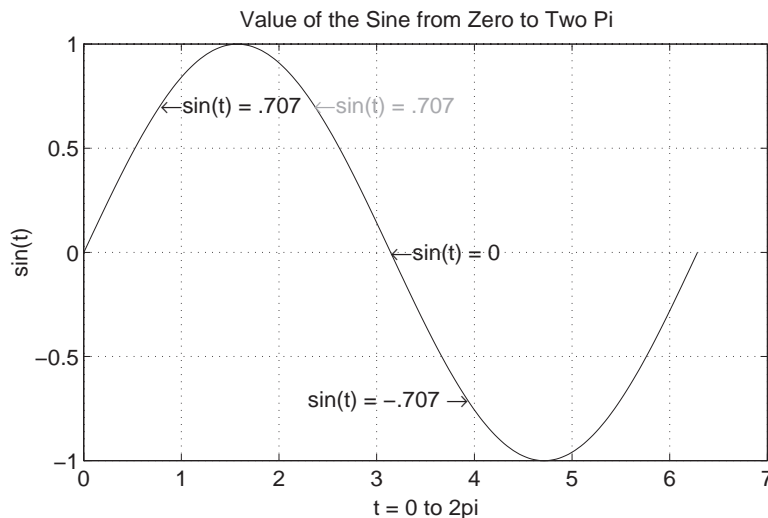

Suppose you want to move the text string labeling the value $\sin(t) = .707$ from its current location at $[\pi/4, \sin(\pi/4)]$ to the point $[3\pi/4, \sin(3\pi/4)]$ where the function has the same value (shown grayed out in the picture). To do

this, you need to determine the handle of the text object labeling that point and change its `Position` property.

To use `findobj`, pick a property value that uniquely identifies the object. This example uses the text `String` property.

```
text_handle = findobj('String','\leftarrowsin(t) = .707');
```

Next move the object to the new position, defining the text `Position` in axes units.

```
set(text_handle,'Position',[3*pi/4,sin(3*pi/4),0])
```

`findobj` also lets you restrict the search by specifying a starting point in the hierarchy, instead of beginning with the root object. This results in faster searches if there are many objects in the hierarchy. In the previous example, you know the text object of interest is in the current axes, so you can type

```
text_handle = findobj(gca,'String','\leftarrowsin(t) = .707');
```

Example — Using Logical Operators and Regular Expression

Suppose you create the following graph and want to modify certain properties of the objects created.

```
x = 0:30;
y = [1.5*cos(x);4*exp(-.1*x).*cos(x);exp(.05*x).*cos(x)];
h = stem(x,y);
set(h(1),'Color','black',...
    'Marker','o',...
    'Tag','Decaying Exponential')
set(h(2),'Color','black',...
    'Marker','square',...
    'Tag','Growing Exponential')
set(h(3),'Color','black',...
    'Marker','*',...
    'Tag','Steady State')
```

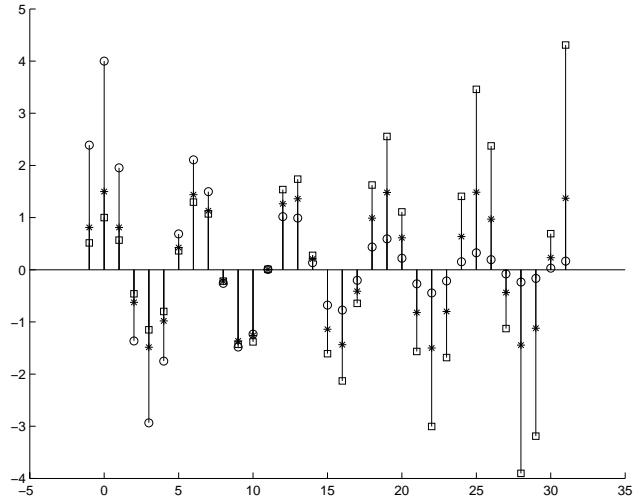

The following instance diagram shows the graphics objects created in the graph. Each of the three sets of data produces a stemseries object, which in turn uses two lines to create the stem graph; one line for the stems and one for the markers that terminate each stem. There is also a line used for the baseline.

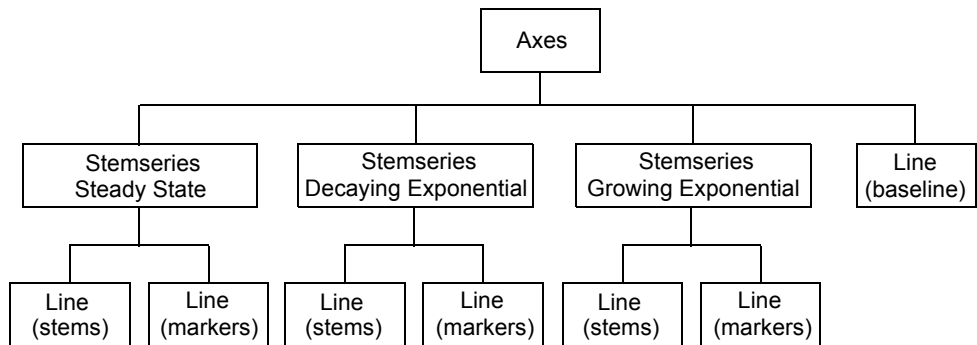

Controlling the Depth of the Search. Now make the baseline into a dashed line. Because it is parented directly to the axes, you can use the following statement to access only this line:

```
set(findobj(gca, '-depth', 1, 'Type', 'line'), 'LineStyle', '--')
```

By setting `-depth` to 1, `findobj` searches only the axes and its immediate children. As you can see from the above instance diagram, the baseline is the only line object parented directly to the axes.

Limiting the Search with Regular Expressions. Increase the value of the `MarkerSize` property by 2 points on all `stemseries` objects that do not have their property `Tag` set to `'Steady State'`.

```
h = findobj('-regexp', 'Tag', '[^Steady State]');
set(h, {'MarkerSize'}, num2cell(cell2mat(get(h, 'MarkerSize'))+2))
```

See the `regexp` function for more information on using regular expressions in MATLAB.

Using Logical Operators. Change the color of the stem lines, but not the stem markers. To do this, you must access the line objects contained by the three `stemseries` objects. You cannot just set the `stemseries` `Color` property because it sets both the line and marker colors.

Search for objects that are of `Type` `line`, have `Marker` set to `none`, and do not have `LineStyle` set to `--`, which is the baseline.

```
h = findobj('type', 'line', 'Marker', 'none', ...
           '-and', '-not', 'LineStyle', '--');
set(h, 'Color', 'red')
```

The following picture shows the graph after making the various changes described in this section.

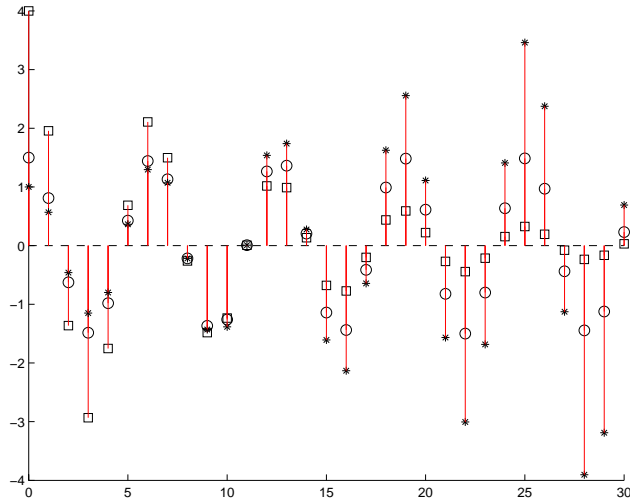

Copying Objects

You can copy objects from one parent to another using the `copyobj` function. The new object differs from the original object only in the value of its `Parent` property and its handle; it is otherwise a clone of the original. You can copy a number of objects to a new parent, or one object to a number of new parents, as long as the result maintains the correct parent/child relationship.

When you copy an object having child objects, MATLAB copies all children as well.

Example — Copying Objects

Suppose you are plotting a variety of data and want to label the point having the x - and y -coordinates determined by 5 in each plot. The `text` function allows you to specify the location of the label in the coordinates defined by the x - and y -axis limits, simplifying the process of locating the text.

```
text('String','\{5\pi\div4, sin(5\pi\div4)\}\rightarrow',...
     'Position',[5*pi/4,sin(5*pi/4),0],...
     'HorizontalAlignment','right')
```

In this statement, the `text` function

- Labels the data point with the string 5 using TeX commands to draw a right-facing arrow and mathematical symbols
- Specifies the Position in terms of the data being plotted
- Places the data point to the right of the text string by changing the `HorizontalAlignment` to `right` (the default is `left`)

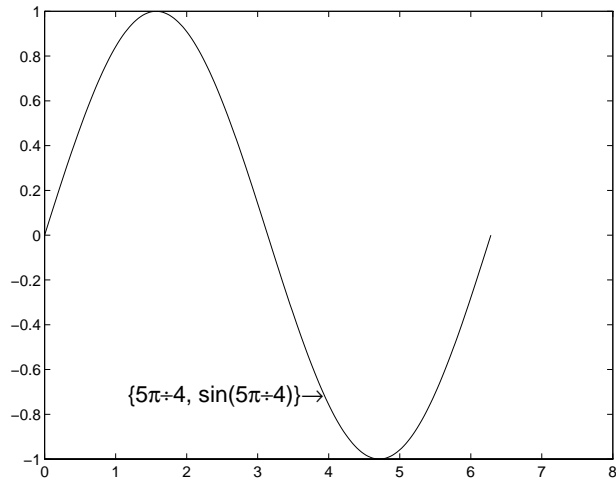

To label the same point with the same string in another plot, copy the text using `copyobj`. Because the last statement did not save the handle to the text object, you can find it using `findobj` and the `'String'` property.

```
text_handle = findobj('String',...
    '\{5\pi\div 4, \sin(5\pi\div 4)\}\rightarrow');
```

After creating the next plot, add the label by copying it from the first plot.

```
copyobj(text_handle, gca).
```

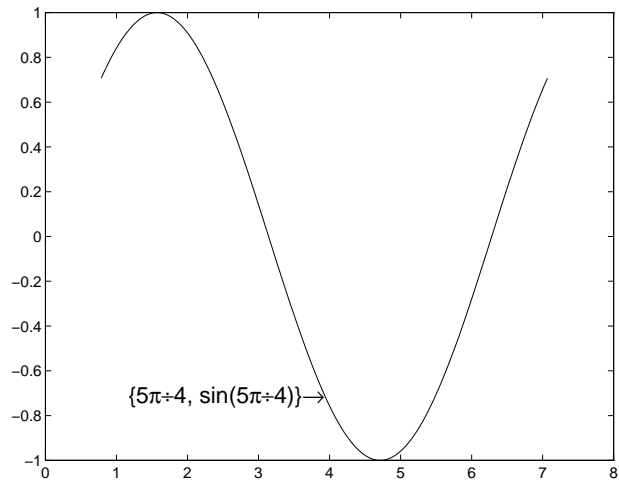

This particular example takes advantage of the fact that text objects define their location in the axes data space. Therefore the text `Position` property did not need to change from one plot to another.

Deleting Objects

You can remove a graphics object with the `delete` command, using the object's handle as an argument. For example, you can delete the current axes (and all of its descendants) with the statement

```
delete(gca)
```

You can use `findobj` to get the handle of a particular object you want to delete. For example, to find the handle of the dotted line in this multiline plot,

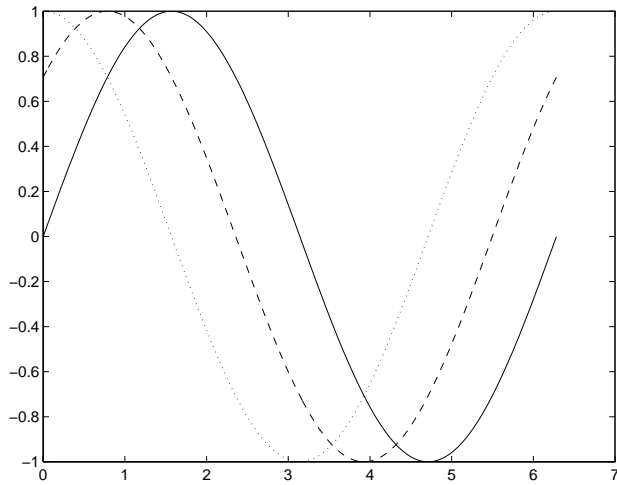

use `findobj` to locate the object whose `LineStyle` property is `':'`

```
line_handle = findobj('LineStyle',':');
```

then use this handle with the `delete` command.

```
delete(line_handle)
```

You can combine these two statements, substituting the `findobj` statement for the handle.

```
delete(findobj('LineStyle',':'))
```

Controlling Graphics Output

MATLAB allows many figure windows to be open simultaneously during a session. A MATLAB application might create figures to display graphical user interfaces as well as plotted data. It is necessary then to protect some figures from becoming the target for graphics display and to prepare (e.g., reset properties and clear existing objects from) others before receiving new graphics.

This section discusses how to control where and how MATLAB displays graphics output. Topics include

- Specifying the target for graphics output
- Preparing the figure and axes to accept new objects
- Protecting figures and axes from becoming targets
- Accessing the handles of protected figure and axes

Specifying the Target for Graphics Output

By default, MATLAB functions that create graphics objects display them in the current figure and current axes (if an axes child). You can direct the output to another parent by explicitly specifying the `Parent` property with the creating function. For example,

```
plot(1:10, 'Parent', axes_handle)
```

where `axes_handle` is the handle of the target axes. The `uicontrol` and `uimenu` functions have a convenient syntax that enables you to specify the parent as the first argument,

```
uicontrol(Figure_handle, ...)  
uimenu(parent_menu_handle, ...)
```

or you can set the `Parent` property.

Preparing Figures and Axes for Graphics

By default, commands that generate graphics output display the graphics objects in the current figure without clearing or resetting figure properties. However, if the graphics objects are axes children, MATLAB clears the axes and resets most axes properties to their default values before displaying the objects.

You can change this behavior by setting the figure and axes `NextPlot` properties.

Using `NextPlot` to Control Output Target

MATLAB high-level graphics functions check the values of the `NextPlot` properties to determine whether to add, clear, or clear and reset the figure and axes before drawing. Low-level object creation functions do not check the `NextPlot` properties. They simply add the new graphics objects to the current figure and axes.

Low-level functions are designed primarily for use in M-files where you can implement whatever drawing behavior you want. However, when you develop a MATLAB-based application, controlling MATLAB drawing behavior is essential to creating a program that behaves predictably.

This table summarizes the possible values for the `NextPlot` property.

NextPlot	Figure	Axes
add	Add new graphics objects without clearing or resetting the current figure. (Default setting)	Add new graphics objects without clearing or resetting the current axes.
replacechildren	Remove all child objects, but do not reset figure properties. Equivalent to <code>clf</code> .	Remove all child objects, but do not reset axes properties. Equivalent to <code>cla</code> .
replace	Remove all child objects and reset figure properties to their defaults. Equivalent to <code>clf reset</code> .	Remove all child objects and reset axes properties to their defaults. Equivalent to <code>cla reset</code> . (Default setting)

Note that a `reset` returns all properties, except `Position` and `Units`, to their default values.

The `hold` command provides convenient access to the `NextPlot` properties. The statement

```
hold on
```

sets both figure and axes `NextPlot` properties to `add`.

The statement

```
hold off
```

sets the axes `NextPlot` property to `replace`.

Targeting Graphics Output with `newplot`

MATLAB provides the `newplot` function to simplify the process of writing graphics M-files that conform to the settings of the `NextPlot` properties.

`newplot` checks the values of the `NextPlot` properties and takes the appropriate action based on these values. You should place `newplot` at the beginning of any M-file that calls object creation functions.

When your M-file calls `newplot`, the following possible actions occur:

1 `newplot` checks the current figure's `NextPlot` property:

- If there are no figures in existence, `newplot` creates one and makes it the current figure.
- If the value of `NextPlot` is `add`, `newplot` makes the figure the current figure.
- If the value of `NextPlot` is `replacechildren`, `newplot` deletes the figure's children (axes objects and their descendants) and makes this figure the current figure.
- If the value of `NextPlot` is `replace`, `newplot` deletes the figure's children, resets the figure's properties to the defaults, and makes this figure the current figure.

2 `newplot` checks the current axes' `NextPlot` property:

- If there are no axes in existence, `newplot` creates one and makes it the current axes.
- If the value of `NextPlot` is `add`, `newplot` makes the axes the current axes.
- If the value of `NextPlot` is `replacechildren`, `newplot` deletes the axes' children and makes this axes the current axes.
- If the value of `NextPlot` is `replace`, `newplot` deletes the axes' children, resets the axes' properties to the defaults, and makes this axes the current axes.

MATLAB Default Behavior

Consider the default situation where the figure `NextPlot` property is `add` and the axes `NextPlot` property is `replace`. When you call `newplot`, it

- 1 Checks the value of the current figure's `NextPlot` property (which is `add`) and determines MATLAB can draw into the current figure with no further action. If there is no current figure, `newplot` creates one, but does not recheck its `NextPlot` property.
- 2 Checks the value of the current axes' `NextPlot` property (which is `replace`), deletes all graphics objects from the axes, resets all axes properties (except `Position` and `Units`) to their defaults, and returns the handle of the current axes.

Example – Using `newplot`

To illustrate the use of `newplot`, this example creates a function that is similar to the built-in `plot` function, except it automatically cycles through different line styles instead of using different colors for multiline plots.

```
function my_plot(x,y)
cax = newplot; % newplot returns handle of current axes
LSO = ['- ' ;'--' ;':' ;'-.'];
set(cax,'FontName','Times','FontAngle','italic')
set(get(cax,'Parent'),'MenuBar','none') %
line_handles = line(x,y,'Color','b');
style = 1;
for i = 1:length(line_handles)
    if style > length(LSO), style = 1;end
    set(line_handles(i),'LineStyle',LSO(style,:))
    style = style + 1;
end
grid on
```

The function `my_plot` uses the high-level line function syntax to plot the data. This provides the same flexibility in input argument dimension that the built-in `plot` function supports. The `line` function does not check the value of the figure or axes `NextPlot` property. However, because `my_plot` calls `newplot`, it behaves the same way the high-level `plot` function does — with default values in place, `my_plot` clears and resets the axes each time you call it.

`my_plot` uses the handle returned by `newplot` to access the target figure and axes. This example sets axes font properties and disables the figure's menu bar. Note how the figure handle is obtained via the axes Parent property.

This picture shows typical output for the `my_plot` function.

```
my_plot(1:10,peaks(10))
```

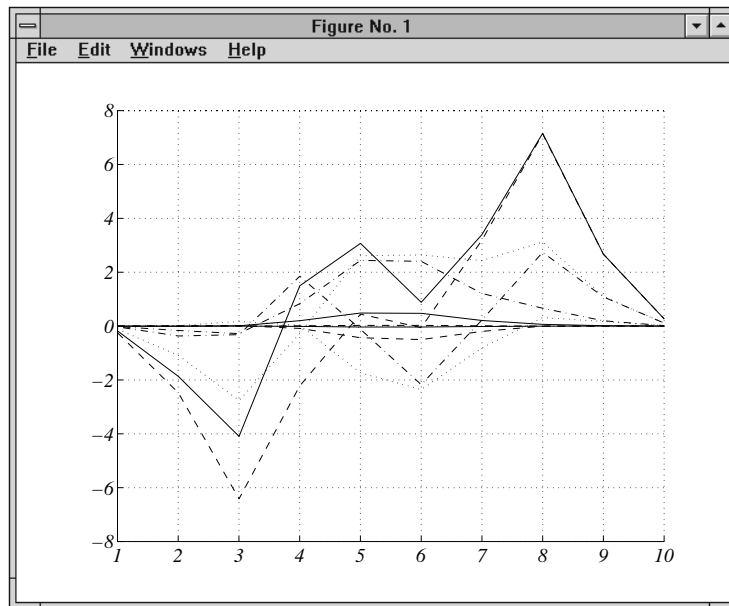

Basic Plotting M-File Structure

This example illustrates the basic structure of graphics M-files:

- Call `newplot` early to conform to the `NextPlot` properties and to obtain the handle of the target axes.
- Reference the axes handle returned by `newplot` to set any axes properties or to obtain the figure's handle.
- Call object creation functions to draw graphics objects with the desired characteristics.

The MATLAB default settings for the `NextPlot` properties facilitate writing M-files that adhere to the standard behavior: reuse the figure window, but clear and reset the axes with each new graph. Other values for these properties allow you to implement different behaviors.

Replacing Only the Child Objects — `replacechildren`

The `replacechildren` value for `NextPlot` causes `newplot` to remove child objects from the figure or axes, but does not reset any property values (except the list of handles contained in the `Children` property).

This can be useful after setting properties you want to use for subsequent graphs without having to reset properties. For example, if you type on the command line

```
set(gca, 'ColorOrder', [0 0 1], 'LineStyleOrder', '-|--|:|-.', ...
    'NextPlot', 'replacechildren')
plot(x,y)
```

`plot` produces the same output as the M-file `my_plot` in the previous section, but only within the current axes. Calling `plot` still erases the existing graph (i.e., deletes the axes children), but it does not reset axes properties. The values specified for the `ColorOrder` and `LineStyleOrder` properties remain in effect.

Testing for Hold State

There are situations in which your M-file should change the visual appearance of the axes to accommodate new graphics objects. For example, if you want the M-file `my_plot` from the previous example to accept 3-D data, it makes sense to set the view to 3-D when the input data has *z*-coordinates.

However, to be consistent with the behavior of the MATLAB high-level routines, it is good practice to test whether `hold` is on before changing parent axes or figure properties. When `hold` is on, the axes and figure `NextPlot` properties are both set to `add`.

The M-file `my_plot3` accepts 3-D data and also checks the hold state, using `ishold`, to determine whether it should change the view.

```
function my_plot3(x,y,z)
cax = newplot;
hold_state = ishold; % ishold tests the current hold state
LSO = ['- ' ; '-- ' ; ':' ; '-.'];
```

```
if nargin == 2
    hlines = line(x,y,'Color','k');
    if ~hold_state % Change view only if hold is off
        view(2)
    end
elseif nargin == 3
    hlines = line(x,y,z,'Color','k');
    if ~hold_state % Change view only if hold is off
        view(3)
    end
end
ls = 1;
for hindex = 1:length(hlines)
    if ls > length(LSO),ls = 1;end
    set(hlines(hindex),'LineStyle',LSO(ls,:))
    ls = ls + 1;
end
```

If hold is on when you call `my_plot3`, it does not change the view. If hold is off, `my_plot3` sets the view to 2-D or 3-D, depending on whether there are two or three input arguments.

Protecting Figures and Axes

There are situations in which it is important to prevent particular figures or axes from becoming the target for graphics output (i.e., preventing them from becoming the `gcf` or `gca`). An example is a figure containing the `uicontrols` that implement a user interface.

You can prevent MATLAB from drawing into a particular figure or axes by removing its handle from the list of handles that are visible to the `newplot` function, as well as any other functions that either return or implicitly reference handles (i.e., `gca`, `gcf`, `gco`, `cla`, `clf`, `close`, and `findobj`). Two properties control handle hiding: `HandleVisibility` and `ShowHiddenHandles`.

HandleVisibility Property

`HandleVisibility` is a property of all objects. It controls the scope of handle visibility within three different ranges. Property values can be

- on — The object's handle is available to any function executed on the MATLAB command line or from an M-file. This is the default setting.

- **callback** — The object's handle is hidden from all functions executing on the command line, even if it is on the top of the screen stacking order. However, during callback routine execution (MATLAB statements or functions that execute in response to user action), the handle is visible to all functions, such as `gca`, `gcf`, `gco`, `findobj`, and `newplot`. This setting enables callback routines to take advantage of the MATLAB handle access functions, while ensuring that users typing at the command line do not inadvertently disturb a protected object.
- **off** — The object's handle is hidden from all functions executing on the command line and in callback routines. This setting is useful when you want to protect objects from possibly damaging user commands.

For example, if a GUI accepts user input in the form of text strings, which are then evaluated (using the `eval` function) from within the callback routine, a string such as `'close all'` could destroy the GUI. To protect against this situation, you can temporarily set `HandleVisibility` to `off` on key objects.

```
user_input = get(editbox_handle,'String');
set(gui_handles,'HandleVisibility','off')
eval(user_input)
set(gui_handles,'HandleVisibility','commandline')
```

Values Returned by `gca` and `gcf`. When a protected figure is topmost on the screen, but has unprotected figures stacked beneath it, `gcf` returns the topmost unprotected figure in the stack. The same is true for `gca`. If no unprotected figures or axes exist, calling `gcf` or `gca` causes MATLAB to create one in order to return its handle.

Accessing Protected Objects

The root `ShowHiddenHandles` property enables and disables handle visibility control. By default, `ShowHiddenHandles` is `off`, which means MATLAB obeys the setting of the `HandleVisibility` property. When `ShowHiddenHandles` is set to `on`, all handles are visible from the command line and within callback routines. This can be useful when you want access to all graphics objects that exist at a given time, including the handles of axes text labels, which are normally hidden.

The `close` function also allows access to nonvisible figures using the `hidden` option. For example,

```
close('hidden')
```

closes the topmost figure on the screen, even if it is protected. Combining `all` and `hidden` options,

```
close('all','hidden')
```

closes all figures.

The Figure Close Request Function

MATLAB executes a callback routine defined by the figure's `CloseRequestFcn` whenever you

- Issue a close command on a figure.
- Quit MATLAB while there are visible figures. (If a figure's `Visible` property is set to `off`, MATLAB does not execute its close request function when you quit MATLAB; the figure is just deleted).
- Close a figure from the windowing system using a close box or a close menu item.

The close request function enables you to prevent or delay the closing of a figure or the termination of a MATLAB session. This is useful to perform such actions as

- Displaying a dialog box requiring the user to confirm the action
- Saving data before closing
- Preventing unintentional command-line deletion of a graphical user interface built with MATLAB

The default callback routine for the `CloseRequestFcn` is an M-file called `closereq`. It contains the statements

```
shh=get(0,'ShowHiddenHandles');  
set(0,'ShowHiddenHandles','on');  
delete(get(0,'CurrentFigure'));  
set(0,'ShowHiddenHandles',shh);
```

This callback disables `HandleVisibility` control by setting the root `ShowHiddenHandles` property to `on`, which makes all figure handles visible.

Quitting MATLAB

When you quit MATLAB, the current figure's `CloseRequestFcn` is called, and if the figure is deleted, the next figure in the root's list of children (i.e., the root's `Children` property) becomes the current figure, and its `CloseRequestFcn` is in turn executed, and so on. You can, therefore, use `gcf` to specify the figure handle from within the close request function.

If you change a figure's `CloseRequestFcn` so that it does not delete the figure (e.g., defining this property as an empty string), then issuing the `close` command on that figure does not cause it to be deleted. Furthermore, if you attempt to quit MATLAB, the quit is aborted because MATLAB does not delete the figure.

Errors in the Close Request Function

If the `CloseRequestFcn` generates an error when executed, MATLAB aborts the close operation. However, errors in the `CloseRequestFcn` do not abort attempts to quit MATLAB. If an error occurs in a figure's `CloseRequestFcn`, MATLAB closes the figure unconditionally following a `quit` or `exit` command.

Overriding the Close Request Function

The `delete` command always deletes the specified figure, regardless of the value of its `CloseRequestFcn`. For example, the statement

```
delete(get(0, 'Children'))
```

deletes all figures whose handles are not hidden (i.e., the `HandleVisibility` property is set to `off`). If you want to delete all figures regardless of whether their handles are hidden, you can set the root `ShowHiddenHandles` property to `on`. The root `Children` property then contains the handles of all figures. For example, the statements

```
set(0, 'ShowHiddenHandles', 'yes')  
delete(get(0, 'Children'))
```

unconditionally delete all figures.

Handle Validity Versus Handle Visibility

All handles remain valid regardless of whether they are visible or not. If you know an object's handle, you can set and get its properties. By default, figure handles are integers that are displayed at the top of the window.

You can provide further protection to figures by setting the `IntegerHandle` property to `off`. MATLAB then uses a floating-point number for figure handles.

Saving Handles in M-Files

Graphics M-files frequently use handles to access property values and to direct graphics output to a particular target. MATLAB provides utility routines that return the handles to key objects (such as the current figure and axes). In M-files, however, these utilities might not be the best way to obtain handles because

- Querying MATLAB for the handle of an object or other information is less efficient than storing the handle in a variable and referencing that variable.
- The current figure, axes, or object might change during M-file execution because of user interaction.

Save Information First

It is good practice to save relevant information about the MATLAB state in the beginning of your M-file. For example, you can begin an M-file with

```
cax = newplot;  
cfig = get(cax, 'Parent');  
hold_state = ishold;
```

rather than querying this information each time you need it. Remember that utility commands like `ishold` obtain the values they return whenever called. (The `ishold` command issues a number of `get` commands and string compares (`strcmp`) to determine the hold state.)

If you are temporarily going to alter the hold state within the M-file, you should save the current values of the `NextPlot` properties so you can reset them later.

```
ax_nextplot = lower(get(cax, 'NextPlot'));  
fig_nextplot = lower(get(cfig, 'NextPlot'));  
.  
.  
.  
set(cax, 'NextPlot', ax_nextplot)  
set(cfig, 'NextPlot', fig_nextplot)
```

Properties Changed by Built-In Functions

To achieve their intended effect, many built-in functions change axes properties, which can then affect the workings of your M-file. This table lists the MATLAB built-in graphics functions and the properties they change. Note that these properties change only if `hold` is off.

Function	Axes Property: Set To
<code>fill</code>	Box: on CameraPosition: 2-D view CameraTarget: 2-D view CameraUpVector: 2-D view CameraViewAngle: 2-D view
<code>fill3</code>	CameraPosition: 3-D view CameraTarget: 3-D view CameraUpVector: 3-D view CameraViewAngle: 3-D view XScale: linear YScale: linear ZScale: linear

Function	Axes Property: Set To
image (high-level)	Box: on Layer: top CameraPosition: 2-D view CameraTarget: 2-D view CameraUpVector: 2-D view CameraViewAngle: 2-D view XDir: normal XLim: [0 size(CData,1)]+0.5 XLimMode: manual YDir: reverse YLim: [0 size(CData,2)]+0.5 YLimMode: manual
loglog	Box: on CameraPosition: 2-D view CameraTarget: 2-D view CameraUpVector: 2-D view CameraViewAngle: 2-D view XScale: log YScale: log
plot	Box: on CameraPosition: 2-D view CameraTarget: 2-D view CameraUpVector: 2-D view CameraViewAngle: 2-D view

Function	Axes Property: Set To
plot3	CameraPosition: 3-D view CameraTarget: 3-D view CameraUpVector: 3-D view CameraViewAngle: 3-D view XScale: linear YScale: linear ZScale: linear
semilogx	Box: on CameraPosition: 2-D view CameraTarget: 2-D view CameraUpVector: 2-D view CameraViewAngle: 2-D view XScale: log YScale: linear
semilogy	Box: on CameraPosition: 2-D view CameraTarget: 2-D view CameraUpVector: 2-D view CameraViewAngle: 2-D view XScale: linear YScale: log

Objects That Can Contain Other Objects

Certain graphics objects can contain other objects. Consider a graph for example. In a graph, data is represented by an object like a line. Normally, the parent of the line is an axes (i.e., the handle of the line's `Parent` property is set to the handle of the axes that contains it). A figure is normally the parent of an axes. A typical object diagram of a graph would look like this:

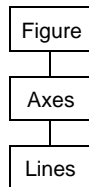

When graphs become more complicated and represent data with multiple objects, it can be useful to group these objects together so you can perform operations on the group as a whole.

These sections discuss how to use two container objects that group axes children within a graph and user interface components within a figure.

- “Using Panel Containers in Figures — `UIPanels`” on page 8-75
- “Grouping Objects Within Axes — `hgtransform`” on page 8-80

Using Panel Containers in Figures — `UIPanels`

Figures can contain axes and user interface objects directly, or you can parent these objects to `uipanel`s, which you then parent to a figure. `Uipanel`s are useful for the design of GUIs because they enable you to define subregions in a figure in which you can lay out components.

MATLAB interprets the `Position` property of all objects parented to a `uipanel` relative to the `uipanel`'s position. If you move the `uipanel`, the children automatically move with it.

`Uipanel`s can also contain other `uipanel`s, as well as axes, `uicontrol`s, and `uibuttongroups`. See the `uipanel` reference page for more information on `uipanel`s.

Figure Resize Functions

Containing various parts of a GUI in uipanel objects simplifies the process of programming figure resize behavior because you can write a separate resize function for each panel. The following example illustrates how to do this.

Example – Using Figure Panels

This example uses three uipanel objects as containers for the GUI's components. All three uipanel objects are then parented to the figure, as shown in the following containment hierarchy.

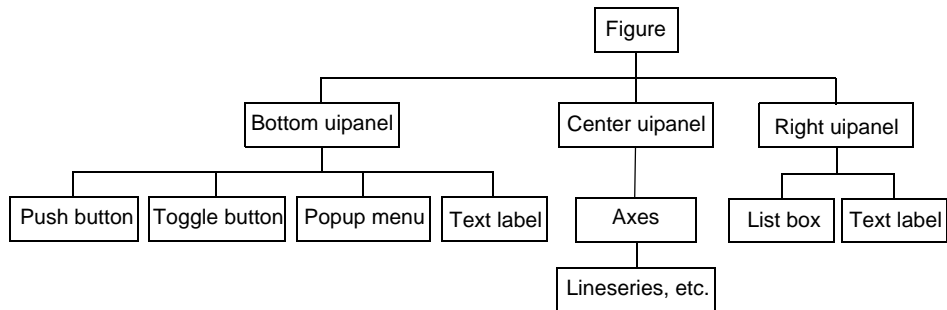

Here is a picture of the GUI with some data plotted in the axes.

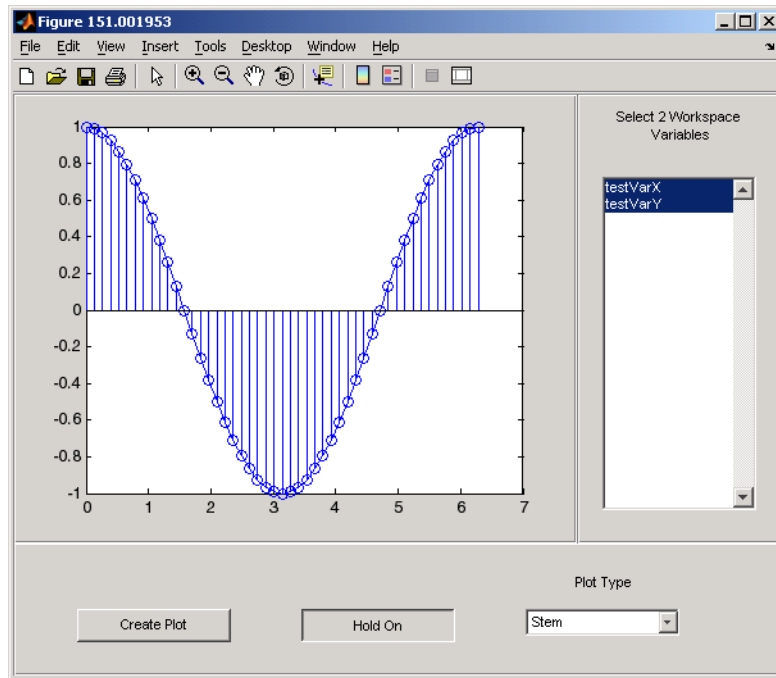

Complete Example Code

Note If you are using the MATLAB Help browser, you can run this example or open it in the MATLAB editor.

This GUI enables you to select workspace variables from a list box and select a plot type from a pop-up menu. You can add plots to the existing graph by clicking the **Hold** toggle button and initiate the plot by clicking the **Create Plot** button.

Use the link above to run the example and open the GUI code in the MATLAB editor.

Creating the Uipanel

The following code shows the definition of the figure and the bottom panel. Setting `Units` to `characters` ensures that your GUI is properly sized on different computer systems. The `Position` property specifies the location and size of each component in units set by the `Units` property.

```
% Create the figure
f = figure('Units','characters',...
    'Position',[30 30 120 35],...
    'Color',panelColor,...
    'HandleVisibility','callback',...
    'IntegerHandle','off',...
    'Renderer','painters',...
    'ResizeFcn',@figResize);

% Create the bottom uipanel
botPanel = uipanel('BorderType','etchedin',...
    'BackgroundColor',panelColor,...
    'Units','characters',...
    'Position',[1/20 1/20 119.9 8],...
    'Parent',f,...
    'ResizeFcn',@botPanelResize);
```

Programming the Resize Functions

As you resize the figure, MATLAB calls the figure resize function (specified by the object's `ResizeFcn` property), which, in this example, computes a new size for each uipanel. Because the figure resize function resizes the uipanel, MATLAB automatically calls the resize function of each uipanel once the figure resize function completes execution. The uipanel resize functions then adjust the sizes and locations of the components they contain.

The following diagram illustrates the sequence of events that occurs when a user resizes the figure.

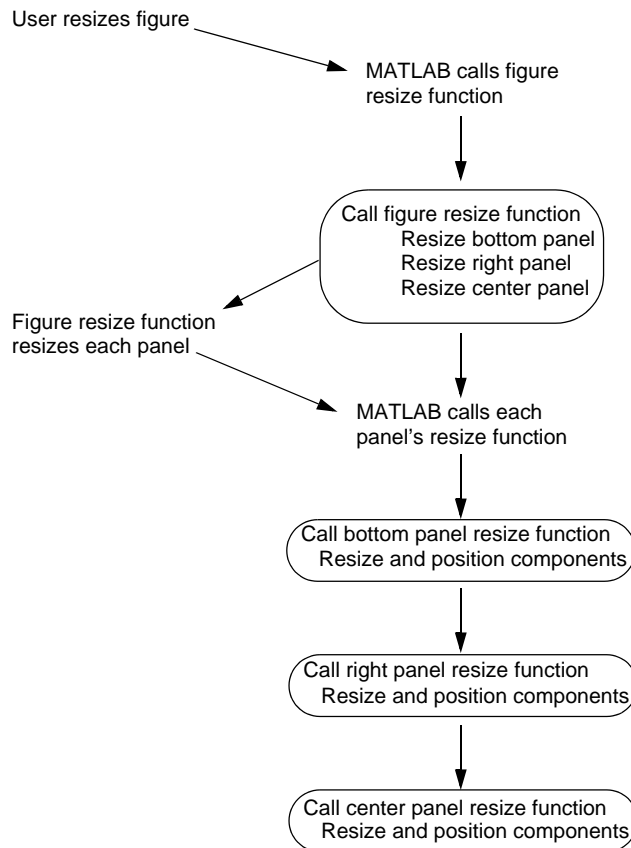

The following code shows the figure, bottom panel, and right panel resize functions. As each function is called, it sets the object's size and position to values that are proportional to the original layout.

See “Nested Functions” for more information.

```

% Figure resize function
function figResize(src,evt)
    fpos = get(f,'Position');
    set(botPanel,'Position',...
        [1/20 1/20 fpos(3)-.1 fpos(4)*8/35])
    set(rightPanel,'Position',...

```

```
        [fpos(3)*85/120 fpos(4)*8/35 fpos(3)*35/120 fpos(4)*27/35])
set(centerPanel,'Position',...
    [1/20 fpos(4)*8/35 fpos(3)*85/120 fpos(4)*27/35]);
end

% Bottom panel resize function
function botPanelResize(src,evt)
    bpos = get(botPanel,'Position');
    set(plotButton,'Position',...
        [bpos(3)*10/120 bpos(4)*2/8 bpos(3)*24/120 2])
    set(holdToggle,'Position',...
        [bpos(3)*45/120 bpos(4)*2/8 bpos(3)*24/120 2])
    set(popUp,'Position',...
        [bpos(3)*80/120 bpos(4)*2/8 bpos(3)*24/120 2])
    set(popUpLabel,'Position',...
        [bpos(3)*80/120 bpos(4)*4/8 bpos(3)*24/120 2])
end

% Right panel resize function
function rightPanelResize(src,evt)
    rpos = get(rightPanel,'Position');
    set(listBox,'Position',...
        [rpos(3)*4/32 rpos(4)*2/27 rpos(3)*24/32 rpos(4)*20/27]);
    set(listBoxLabel,'Position',...
        [rpos(3)*4/32 rpos(4)*24/27 rpos(3)*24/32 rpos(4)*2/27]);
end
```

Note that the center panel does not need a resize function because the axes automatically resize to fit the container (either a figure or uipanel).

To see the complete code listing for this example, see “Complete Example Code” on page 8-77.

Grouping Objects Within Axes – hgtransform

MATLAB provides two objects that are designed to group any of the objects normally parented to axes. These two objects are

- **Hggroup** — Parent objects to an hggroup object when you want to reference the objects as a group. For example, to select or control visibility of all the group members.

- Hgtransform — This object also enables you to transform (rotate, translate, etc.) the objects as a group.

See “Group Objects” on page 8-25 for more information about hggroup and hgtransform objects.

Example — Translating Grouped Objects

This example shows how using a hierarchy of hgtransform objects makes it possible to translate the contained graphics objects both independently and as a group. The example creates a cross-like cursor with a text readout in the center, which displays data values.

The cursor is constructed from two surfaces, each of which is contained in an hgtransform object so they can be translated independently to overlap, and a text object. These two hgtransform objects are then contained by a third hgtransform object, which also contains the text. This third hgtransform (with handle T in the diagram and code) enables the cursor to be transformed as a group.

The following diagram shows the containment hierarchy for this example. The axes contains a line, which is used to plot the data that the cursor moves along. The axes also contains the hierarchy of hgtransform objects that construct the cursor.

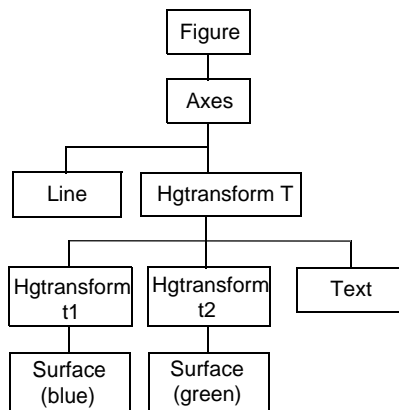

Note If you are using the MATLAB Help browser, you can run this example or open it in the MATLAB editor.

Set Up the Axes and Figure. The first step is to create an axes with fixed limits so MATLAB does not rescale the limits as the cursor moves along the line. Creating the axes automatically creates a figure to contain it.

Set figure properties to use the OpenGL renderer and double buffering:

```
h_axes = axes('XLim',[-10 10],'YLim',[-5 5]);
set(get(h_axes,'Parent'),'Renderer','opengl',...
    'DoubleBuffer','on')
```

Define the Transform Matrices and Hgtransform Objects. The cross part of the cursor is formed from two surface objects, which are translated to overlap. Each surface is contained in its own hgtransform object (handles t1 and t2) because they are translated in different directions. Both hgtransform objects are themselves contained in another hgtransform object (handle T).

See `makehgtform`, `hgtransform`.

```
% Create transform matrices
tmtx1 = makehgtform('translate',[-.5 0 0]);
tmtx2 = makehgtform('translate',[0 -.5 0]);

% Create hgtransform objects
T = hgtransform; % Contains the cursor
t1 = hgtransform('Parent',T,'Matrix',tmtx1);
t2 = hgtransform('Parent',T,'Matrix',tmtx2);
```

Create the Surface and Text Objects. The cursor is composed of two surface objects and a text object (to display data values). The two surfaces are parented to their respective hgtransform objects. The text is parented directly to the top-level hgtransform. The text object does not need coordinates because it is translated along with the surfaces in the top-level hgtransform object (T).

See `cylinder`, `surface`, `text`.

```
% Define surfaces and text
[sx,sy,sz] = cylinder([0 2 0]); % Use cylinder to generate data
```



```

surface(sz,sy,sx,'FaceColor','green',...
        'EdgeColor','none','FaceAlpha',.2,'Parent',t1);
surface(sx,sz./1.5,sy,'FaceColor','blue',...
        'EdgeColor','none','FaceAlpha',.2,'Parent',t2);
h_text = text('FontSize',12,'FontWeight','bold',...
              'HorizontalAlignment','center',...
              'VerticalAlignment','Cap','Parent',T);

```

Generate Data and Plot a Line. This example uses a line plot of a mathematical function to create a path along which to move the cursor.

```

% Plot the data x, y, and z
x = -10:.05:10;
y = [cos(x) + exp(-.01*x).*cos(x) + exp(.07*x).*sin(3*x)];
z = 1:length(x);
line(x,y)

```

Translate the Cursor Along the Plotted Line. To move the cursor along the line, a new transform matrix is calculated using each set of x, y, and z data points and used to set the `Matrix` property of the top-level `hgtransform` `T`. At the same time, the text object `String` property is updated to display the value of the current y data point.

The surfaces and the text translate together because all are contained in the top-level `hgtransform` object.

```

% Loop through the line data to move the cursor
for ind = 1:length(x)
    set(T,'Matrix',...
        makehgtform('translate',[x(ind) y(ind) z(ind)]))
    set(h_text,'String',num2str(y(ind)))
    drawnow,pause(.01)
end

```

Callback Properties for Graphics Objects

A *callback* is a function that executes when a specific event occurs on a graphics object. You specify a callback by setting the appropriate property of the object. This section describes the events (specified via properties) for which you can define callbacks. See “Function Handle Callbacks” on page 8-86 for information on how to define callbacks.

Graphics Object Callbacks

All graphics objects have three properties for which you can define callback routines:

- `ButtonDownFcn` — Executes when users click the left mouse button while the cursor is over the object or within a 5-pixel border around the object
- `CreateFcn` — Executes during object creation after all properties are set
- `DeleteFcn` — Executes just before deleting the object

User Interface Object Callbacks

User interface objects (e.g., `uicontrol` and `uimenu`) have a `Callback` property through which you define the function to execute when users activate these devices (e.g., click a push button or select a menu).

Figure Callbacks

Figures have additional properties that execute callback routines with the appropriate user action. Only the `CloseRequestFcn` property has a callback defined by default:

- `CloseRequestFcn` — Executes when a request is made to close the figure (by a `close` command, by the window manager menu, or by quitting MATLAB)
- `KeyPressFcn` — Executes when users press a key while the cursor is within the figure window
- `ResizeFcn` — Executes when users resize the figure window
- `WindowButtonDownFcn` — Executes when users click a mouse button while the cursor is over the figure background, a disabled `uicontrol`, or the axes background

- `WindowButtonMotionFcn` — Executes when users move the mouse button within the figure window (but not over menus or title bar)
- `WindowButtonUpFcn` — Executes when users release the mouse button, after having pressed the mouse button within the figure

Function Handle Callbacks

Handle Graphics objects have a number of properties for which you can define callback functions. When a specific event occurs (e.g., a user clicks a push button or deletes a figure), the corresponding callback function executes. You can specify the value of a callback property as a

- String that is a MATLAB command or the name of an M-file
- Cell array of strings
- Function handle or a cell array containing a function handle and additional arguments

The following sections illustrate how to define function handle callbacks for Handle Graphics objects.

- “Function Handle Syntax” on page 8-86 describes how to define a function handle callback.
- “Why Use Function Handle Callbacks” on page 8-88 provides information on the advantages of using function handle callbacks.
- “Example — Using Function Handles in GUIs” on page 8-90 shows how to create a simple GUI that uses function handle callbacks.

For general information on function handles, see the function handle reference page.

Function Handle Syntax

In Handle Graphics, functions that you want to use as function handle callbacks must define at least two input arguments in the function definition:

- The handle of the object generating the callback (the source of the event)
- The event data structure (can be empty for some callbacks)

MATLAB passes these two arguments implicitly whenever the callback executes. For example, consider the following statements, which are contained in a single M-file.

```
function myGui
% Create a figure and specify a callback
figure('WindowButtonDownFcn',@myCallback)
```

```

        .
        .
        % Callback subfunction defines two input arguments
        function myCallback(src,eventdata)
        .
        .
        .

```

The first statement creates a figure and assigns a function handle to its `WindowButtonDownFcn` property (created by using the `@` symbol before the function name). This function handle points to the subfunction `myCallback`. The definition of `myCallback` must specify the two required input arguments in its function definition line.

Passing Additional Input Arguments

You can define the callback function to accept additional input arguments by adding them to the function definition. For example,

```
function myCallback(src,eventdata,arg1,arg2)
```

When using additional arguments for the callback function, you must set the value of the property to a cell array (i.e., enclose the function handle and arguments in curly braces). For example,

```
figure('WindowButtonDownFcn',{@myCallback,arg1,arg2})
```

Defining Callbacks as a Cell Array of Strings — Special Case

Defining a callback as a cell array of strings is a special case because MATLAB treats it differently from a simple string. Setting a callback property to a string causes MATLAB to evaluate that string in the base workspace when the callback is invoked. However, setting a callback to a cell array of strings requires the following:

- The cell array must contain the name of an M-file that is on the MATLAB path as the first string element.
- The M-file callback must define at least two arguments (the handle of the callback object and an empty matrix).
- Any additional strings in the cell array are passed to the M-file callback as arguments.

For example,

```
figure('WindowButtonDownFcn', {myCallback, arg1})
```

requires you to define a function M-file that uses three arguments,

```
function myCallback(src, eventdata, arg1)
```

Why Use Function Handle Callbacks

Using function handles to specify callbacks provides some advantages over the use of strings, which must be either MATLAB commands or the name of an M-file that will be on the MATLAB path at run-time.

Single File for All Code

Function handles enable you to use a single M-file for all callbacks. This is particularly useful when you are creating graphical user interfaces, because you can include both the layout commands and callbacks in one file.

For information on how to access subfunctions, see the “Calling a Function Through Its Handle” section of “Programming and Data Types” in the Using MATLAB documentation.

Keeping Variables in Scope

When MATLAB evaluates function handles, the same variables are in scope as when the function handle was created. (In contrast, callbacks specified as strings are evaluated in the base workspace.) This simplifies the process of managing global data, such as object handles in a GUI.

For example, suppose you create a GUI with a list box that displays workspace variables and a push button whose callback creates a plot using the variables selected in the list box. The push button callback needs the handle of the list box to query the names of the selected variables. Here’s what to do.

- 1 Create the list box and save the handle:

```
h_listbox = uicontrol('Style','listbox',... etc.);
```

- 2 Pass the list box handle to the push button’s callback, which is defined in the same M-file:

```
h_plot_button = uicontrol('Style','pushbutton',...
```

```
'Callback',{@plot_button_callback,h_listbox},...etc.);
```

The handle of the list box is now available in the plot button's callback without relying on global variables or using `findobj` to search for the handle. See “Example — Using Function Handles in GUIs” on page 8-90 for an example that uses this technique.

Callback Object Handle and Event Data

MATLAB passes additional information to the callback when it is executed. This information includes the handle of the callback object (the source of the callback event) and event data that is specific to the particular callback property.

For example, the event data returned for the figure `KeyPressFcn` property is a structure that contains information about which keys were pressed.

Information about the event data associated with any given callback property is included with the property's documentation. Use the Handle Graphics Property Browser to access property documentation.

Function Handles Stay in Scope

A function handle can point to a function that is not in scope at the time of execution. For example, the function can be a subfunction in another M-file.

For a general discussion of function handles, see the “Function Handles and Anonymous Functions in the MATLAB documentation.”

Example – Using Function Handles in GUIs

This example creates a simple GUI that plots workspace variables. It is defined in a single M-file that contains both the layout commands and the callbacks. This example uses function handles to specify callback functions. Callbacks are implemented as nested functions to reduce the need to pass variables as arguments.

See “Function Handle Callbacks” on page 8-86 for more information on the use of function handle callbacks.

Complete Example Code

The documentation for this example does not list all the code used to lay out and program the GUI. To see a complete code listing, use the links in the note box below.

Note If you are using the MATLAB Help browser, you can run this example or open it in the MATLAB editor.

The GUI Layout

The following picture shows the GUI after running the example code. The program creates two variables (`testvarX` and `testVarY`) in the base workspace for testing purposes.

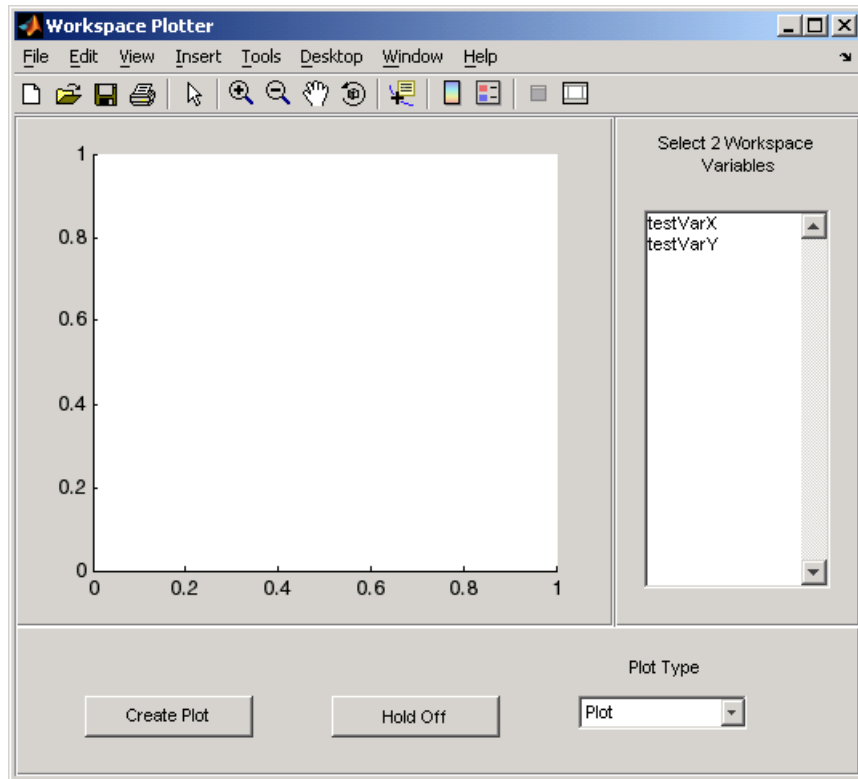

The GUI layout is split among three uipanel containers. One contains the axes, the right side panel contains a list box to display workspace variables, and the bottom panel contains the plot and hold buttons and the plot type pop-up menu.

Initialize the GUI

The list box and the hold toggle button need to be initialized before the GUI is ready to use. This is accomplished by executing their callbacks. Note that because you are calling these functions directly, MATLAB does not implicitly pass the first two arguments, as it would if these functions were executed as callbacks in response to an event. You therefore must explicitly pass all arguments in these function calls.

```
% Initialize list box and make sure
```

```
% the hold toggle is set correctly
listBoxCallback(listBox,[])
holdToggleCallback(holdToggle,[])
```

The Callback Functions

The GUI components that have callbacks are the list box, toggle button, and plot push button. In addition, the figure's three uipanel define resize functions that MATLAB executes whenever users resize the figure.

See “Programming the Resize Functions” on page 8-78 for information on writing callback functions for the figure and uipanel `ResizeFcn` properties.

List Box Callback

The list box callback generates a list of the current variables in the base workspace using the `evalin` and `who` functions. It then assigns this list to the list box `String` property so that it displays these variable names.

Note how the function takes advantage of the fact that the first argument passed to the callback is the handle of the callback object (i.e., the source of the callback event, which is the list box). Therefore, whenever you click in the list box, MATLAB updates the list to display the current workspace variables.

```
%% Callback for list box
function listBoxCallback(src,evt)
    % Load workspace vars into list box
    vars = evalin('base','who');
    set(src,'String',vars)
end % listBoxCallback
```

Plot Button Callback

The plot button callback performs three tasks:

- Gets the names of the variables selected by the user in the list box
- Gets the type of plot selected by the user in the pop-up menu
- Constructs and evaluates the plotting command in the MATLAB base workspace

```
%% Callback for plot button
function plotButtonCallback(src,evt)
    % Get workspace variables
```

```

vars = get(listBox, 'String');
var_index = get(listBox, 'Value');
if length(var_index) ~= 2
    errordlg('You must select two variables',...
        'Incorrect Selection', 'modal')
    return
end
% Get data from base workspace
x = evalin('base', vars{var_index(1)});
y = evalin('base', vars{var_index(2)});
% Get plotting command
selected_cmd = get(popUp, 'Value');
% Make the GUI axes current and create plot
axes(a)
switch selected_cmd
case 1 % user selected plot
    plot(x,y)
case 2 % user selected bar
    bar(x,y)
case 3 % user selected stem
    stem(x,y)
end
end % plotButtonCallback

```

Hold State Toggle Button Callback

The toggle button callback requires the handles of the GUI figure and axes. Because these callbacks are written as nested functions, the figure handle (f) and the axes handle (a) are in scope within the callback.

You want the GUI to toggle the hold state, but the GUI figure handle is hidden. It is necessary, therefore, to use the axes handle as the first argument to the hold function.

```

%% Callback for hold state toggle button
function holdToggleCallback(src, evt)
    button_state = get(src, 'Value');
    if button_state == get(src, 'Max')
        % toggle button is depressed
        hold(a, 'on')
        set(src, 'String', 'Hold On')
    end
end

```

```
elseif button_state == get(src,'Min')
    % toggle button is not depressed
    hold(a,'off')
    set(src,'String','Hold Off')
end
end % holdToggleCallback
```

Figure Properties

Figure Objects (p. 9-2)	Where to find information about figures
Docking Figures in the Desktop (p. 9-3)	Properties that control figure docking
Positioning Figures (p. 9-5)	Properties used to position figures and how they are measured
Figure Colormaps — The Colormap Property (p. 9-9)	Specifying the figure colormap
Selecting Drawing Methods (p. 9-10)	How to select rendering methods and when to use double buffering and backing store
Specifying the Figure Pointer (p. 9-13)	How to select from predefined pointers or define custom pointers

Figure Objects

Figure graphics objects are the windows in which MATLAB displays graphics. Figure properties enable you to control many aspects of these windows, such as their size and position on the screen, the coloring of graphics objects displayed within them, and the scaling of printed pictures.

This section discusses some of the features that are implemented through figure properties and provides examples of how to use these features. The table in the figure reference page listing all properties provides an overview of the characteristics affected by figure properties.

See Figure Properties for a description of each property

Related Information About Figures

For more information about figures, see the following links:

“Graphics Windows — the Figure” on page 8-5

“Preparing Figures and Axes for Graphics” on page 8-60

“Protecting Figures and Axes” on page 8-66

“The Figure Close Request Function” on page 8-68

“Using Panel Containers in Figures — UIPanels” on page 8-75

“Programming the Resize Functions” on page 8-78

“Figure Callbacks” on page 8-84

“Example — Simulating Multiple Colormaps in a Figure” on page 10-31

“Displaying Multiple Plots per Figure” on page 4-27

Docking Figures in the Desktop

You can dock figures in the MATLAB desktop by clicking the dock button, , which appears on the right end of the menu bar. Once docked, figures are placed in a figure group container, which you can also dock and undock.

You can select from a variety of arrangements of the figures in the container. The following picture shows how to select various figure arrangements. Once docked, the figure container displays the toolbar and menubar of the figure with focus.

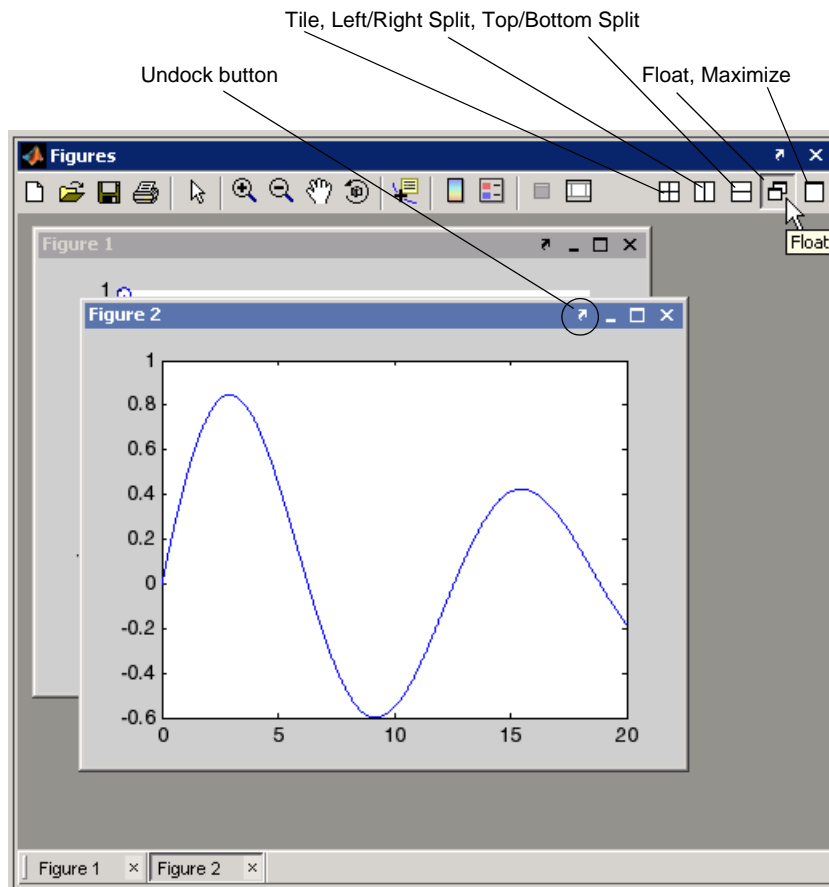

Figure Properties That Affect Docking

There are two figure properties that are related to figure docking — `DockControls` and `WindowState`.

DockControls

The `DockControls` property controls the display of the controls used to dock figures. Setting `DockControls` to `off` removes the dock button from the menubar and disables docking from the figure **Desktop** menu.

WindowState

When you set the `WindowState` property to `docked`, MATLAB docks the figure in the desktop within a figure group container.

If `WindowState` is set to `docked`,

- MATLAB automatically sets `DockControls` to `on`.
- You cannot set the `DockControls` property to `off`.
- You cannot set the figure `Position` property.

Creating a Nondockable Figure

In cases where you do not want users to be able to dock figures (e.g., figures used for GUIs), you should set figure properties as follows:

- `DockControls` to `off`
- `WindowState` to `normal` or `modal`
- `HandleVisibility` to `off` or `callback`

Positioning Figures

The figure `Position` property controls the size and location of the figure window on the root screen. At startup, MATLAB determines the size of your computer screen and defines a default value for `Position`. This default creates figures about one-quarter of the screen's size and places them centered left to right and in the top half of the screen.

The Position Vector

MATLAB defines the figure `Position` property as a vector.

```
[left bottom width height]
```

`left` and `bottom` define the position of the first addressable pixel in the lower left corner of the window, specified with respect to the lower left corner of the screen. `width` and `height` define the size of the interior of the window (i.e., exclusive of the window border).

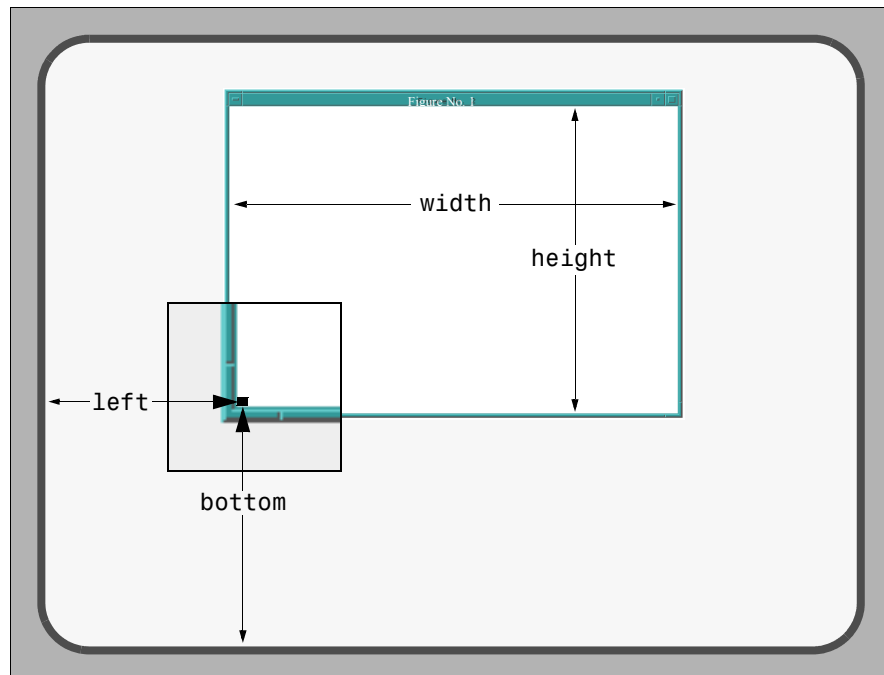

MATLAB does not measure the window border when placing the figure; the `Position` property defines only the internal active area of the figure window.

Because figures are windows under the control of your computer's windowing system, you can move and resize figures as you would any other windows. MATLAB automatically updates the `Position` property to the new values.

Units

The figure's `Units` property determines the units of the values used to specify the position on the screen. Possible values for the `Units` property are

```
set(gcf, 'Units')
[ inches | centimeters | normalized | points | {pixels} |
 characters]
```

with `pixels` being the default. These choices allow you to specify the figure size and location in absolute units (such as inches) if you want the window always to be a certain size, or in units relative to the screen size (such as pixels).

Characters are units that enable you to define the location and size of the figure in units that are based on the size of the default system font. See “Example — Using Figure Panels” on page 8-76 for an example that uses character units.

Determining Screen Size

Whatever units you use, it is important to know the extent of the screen in those units. You can obtain this information from the root `ScreenSize` property. For example,

```
get(0, 'ScreenSize')
ans =
    1    1 1152  900
```

In this case, the screen is 1152 by 900 pixels. MATLAB returns the `ScreenSize` in the units determined by the root `Units` property. For example,

```
set(0, 'Units', 'normalized')
```

normalizes the values returned by `ScreenSize`.

```
get(0, 'ScreenSize')
ans =
    0    0    1    1
```

Defining the figure `Position` in terms of the `ScreenSize` in normalized units makes the specification independent of variations in screen size. This is useful if you are writing an M-file that is to be used on different computer systems.

Example – Specifying Figure Position

Suppose you want to define two figure windows that occupy the upper third of the computer screen (e.g., one for uicontrols and the other to display data). To position the windows precisely, you must consider the window borders when calculating the size and offsets to specify for the `Position` properties.

- 1 The figure `Position` property does not include the window borders, so this example uses a width of 5 pixels on the sides and bottom and 30 pixels on the top.

```
bdwidth = 5;  
topbdwidth = 30;
```

- 2 Ensure root units are pixels and get the size of the screen:

```
set(0, 'Units', 'pixels')  
scnsize = get(0, 'ScreenSize');
```

- 3 Define the size and location of the figures:

```
pos1 = [bdwidth,...  
        2/3*scnsize(4) + bdwidth,...  
        scnsize(3)/2 - 2*bdwidth,...  
        scnsize(4)/3 - (topbdwidth + bdwidth)];  
pos2 = [pos1(1) + scnsize(3)/2,...  
        pos1(2),...  
        pos1(3),...  
        pos1(4)];
```

- 4 Create the figures:

```
figure('Position', pos1)  
figure('Position', pos2)
```

The two figures now occupy the top third of the screen.

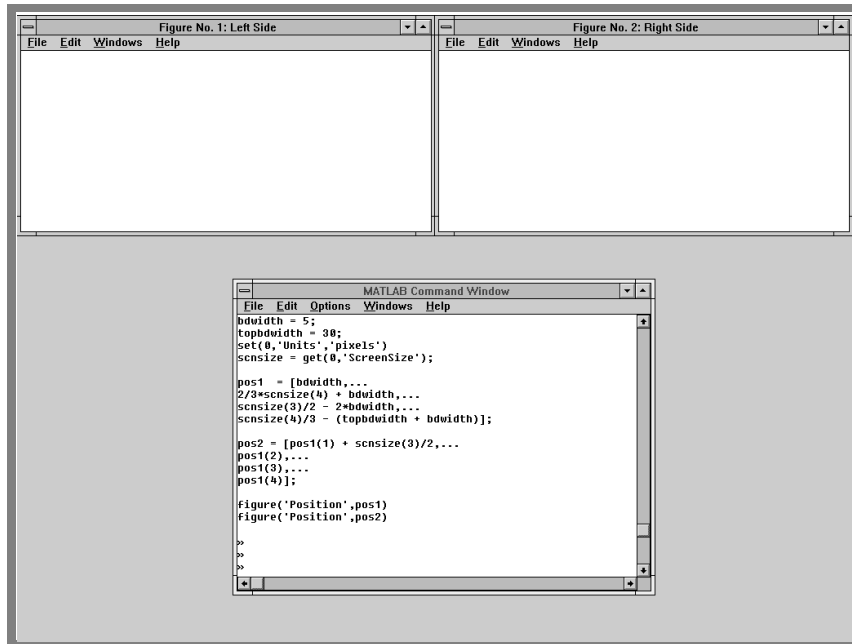

Figure Colormaps — The Colormap Property

MATLAB defines a colormap as a three-column array. Each row of the array defines a particular color by giving three values in the range [0...1]. These values specify the RGB values; the intensity of the red, green, and blue video components.

Colormaps enable you to control how MATLAB maps data values to colors in surfaces, patches, images, and plotting functions that are based on these objects. See the following sections for more information.

Coloring Mesh and Surface Plots in 3-D Visualization

Specifying Patch Coloring in 3-D Visualization

“The Image Object and Its Properties” on page 6-25

Specifying the Figure Colormap

The figure `Colormap` property contains the colormap array. You can specify the figure colormap by setting this property to an m -by-3 array, where m is the number of colors in the colormap.

For example, the following statement creates a figure with a colormap having 128 random colors.

```
figure('Colormap',rand(128,3));
```

The `colormap` function is an easy way to specify the colormap. MATLAB also provides a number of functions that generate colormaps. For example,

```
colormap(hsv(96))
```

sets the colormap of the current figure to a 96 element version of the `hsv` colormap. See the `colormap` reference page for a list of predefined colormaps. Note that the default colormap is `jet(64)`.

Selecting Drawing Methods

MATLAB enables you to select different techniques for drawing graphics. The combination of settings you select depends on the type of graphics you are producing.

There are four figure properties that affect how MATLAB draws graphics:

- `BackingStore` — Allows faster redrawing when obscured figure windows are exposed
- `DoubleBuffer` — Produces flash-free rendering for simple animations
- `Renderer` and `RendererMode` — Specifies different rendering methods or allows MATLAB to make the selection

Backing Store

Overview

Set `BackingStore` to `on` to produce fast redraws of previously obscured windows. Disable `BackingStore` to use less system memory.

More Details

The term “backing store” refers to an offscreen pixel buffer used to store a copy of the figure window’s contents. When you move or delete windows on your display, previously obscured windows can become exposed (even partially), requiring the computer system to redraw these windows. With backing store enabled, MATLAB simply copies an exposed figure window’s contents from the buffer to the screen.

The `BackingStore` property is `on` by default because this provides the most desirable behavior. However, the offscreen pixel buffers required for each figure window do consume system memory. If memory is limited on your system, set `BackingStore` to `off` to release the memory used by these buffers.

Double Buffering

Overview

Set `DoubleBuffer` to `on` when you are animating lines rendered in painters with `EraseMode` set to `normal`.

More Details

Double buffering is the process of drawing into an offscreen pixel buffer and then blitting the buffer contents to the screen once the drawing is complete (instead of drawing directly to the screen, where the process of drawing is visible as it progresses). Double buffering generally produces flash-free rendering for simple animations (such as those involving lines, as opposed to objects containing large numbers of polygons).

The figure `DoubleBuffer` property accepts the values `on` and `off`, with `off` being the default. You can select double buffering only when the figure `Renderer` property is set to `painters`. `Zbuffer` always uses double buffering and ignores this property. `OpenGL` does not use double buffering.

Use double buffering with the animated object's `EraseMode` property set to `normal`.

Selecting a Renderer

Overview

MATLAB automatically selects the best renderer based on the complexity of the graphics objects and the options available on your system.

More Details

A renderer is the software that processes graphics data (such as vertex coordinates) into a form that MATLAB can use to draw into the figure. MATLAB supports three renderers:

- `Painters`
- `Z-buffer`
- `OpenGL`

Painters

`Painters` method is faster when the figure contains only simple or small graphics. It cannot be used with lighting.

Z-Buffer

`Z-buffering` is the process of determining how to render each pixel by drawing only the front-most object, as opposed to drawing all objects back to front,

redrawing objects that obscure those behind. The pixel data is buffered and then blitted to the screen all at once.

Z-buffering is generally faster for more complex graphics, but can be slower for very simple graphics. You can set the `Renderer` property to whatever produces the fastest drawing (either `zbuffer` or `painters`), or let MATLAB decide which method to use by setting the `RendererMode` property to `auto` (the default).

Printing from Z-Buffer. You can select the resolution of the PostScript file produced by the `print` command using the `-r` option. By default, MATLAB prints Z-buffered figures at a medium resolution of 150 dpi (the default with `Renderer` set to `painters` is 864 dpi).

The size of the file generated from a Z-buffer figure does not depend on its contents, just the size of the figure. To decrease the file size, make the `PaperPosition` property smaller before printing (or set `PaperPositionMode` to `auto` and resize the figure window).

OpenGL

OpenGL is available on many computer systems. It is generally faster than either `painters` or Z-buffer and in some cases enables MATLAB to use the system's graphics hardware (which results in significant speed increase). See the figure `Renderer` property for more information.

Limitations of OpenGL. OpenGL has two limitations when compared to `painters` and Z-buffer:

- OpenGL does not interpolate colors within the figure colormap; all color interpolation is performed through the RGB color cube, which can produce unexpected results.
- OpenGL does not support Phong lighting.









Specifying the Figure Pointer







MATLAB indicates the position of the pointer (cursor) within the figure window using a graphical symbol. You can select a pointer from 15 predefined symbols (see table below) or you can define your own symbol. By convention, each of the predefined symbols has a purpose associated with it (although MATLAB enforces no rules for the use of any symbols).

You specify the pointer symbol by setting the value of the figure `Pointer` property. For example, this statement sets the pointer in the current figure (`gcf`) to an arrow.

```
set(gcf, 'Pointer', 'arrow')
```

The following table shows the predefined symbols, the associated specifier, and describes typical use.

Purpose	Specifier	Typical Symbol
Locate a point on a graphics object	crosshair	+
Select a point anywhere in the figure	arrow	
Indicate the system is busy	watch	
Resize an object from the top-left corner	topl	
Resize an object from the top-right corner	topr	
Resize an object from the bottom-left corner	botl	
Resize an object from the bottom-right corner	botr	
View the actual hot spot	circle	
Locate a point	cross	

Purpose	Specifier	Typical Symbol
Use as popular symbol	fleur	
Resize an object from the left side	left	
Resize an object from the right side	right	
Resize an object from the top	top	
Resize an object from the bottom	bottom	
Align a point with other objects on the display	fullcross	
See the next section for information on defining your own pointer shape	custom	

Defining Custom Pointers

When you set the Pointer property to custom, MATLAB displays the pointer you define using the `PointerShapeCData` and the `PointerShapeHotSpot` properties. Custom pointers are 16-by-16 pixels, where each pixel can be either black, white, or transparent.

Specify the pointer by creating a 16-by-16 matrix containing elements that are

- 1's where you want the pixel black
- 2's where you want the pixel white
- NaNs where you want the pixel transparent

Assign the matrix to the figure `PointerShapeCData` property. MATLAB displays the defined pointer whenever the pointer is in the figure window.

The `PointerShapeHotSpot` property specifies the pixel that indicates the pointer location. MATLAB then stores this location in the root `PointerLocation` property. Set the `PointerShapeHotSpot` property to a two-element vector specifying the row and column indices in the `PointerShapeCData` matrix that correspond to the pixel specifying the location.

The default value for this property is [1 1], which corresponds to the upper left corner of the pointer.

Example — Two Custom Pointers

One way to create a custom pointer is to assign values to a 16-by-16 matrix by hand, as illustrated in the following example.

First, initialize the matrix, setting all values to 2. Create a black border 1 pixel wide. Add alignment marks.

```
P = ones(16)+1;
P(1,:) = 1; P(16,:) = 1;
P(:,1) = 1; P(:,16) = 1;
P(1:4,8:9) = 1; P(13:16,8:9) = 1;
P(8:9,1:4) = 1; P(8:9,13:16) = 1;
P(5:12,5:12) = NaN; % Create a transparent region in the center
set(gcf, 'Pointer', 'custom', 'PointerShapeCData', P, ...
    'PointerShapeHotSpot', [9 9])
```

The last statement sets the `Pointer` property to `custom`, assigns the matrix to the `PointerShapeCData` property, and selects element (9,9) as the “hot spot.”

MATLAB now uses the custom pointer within the figure window.

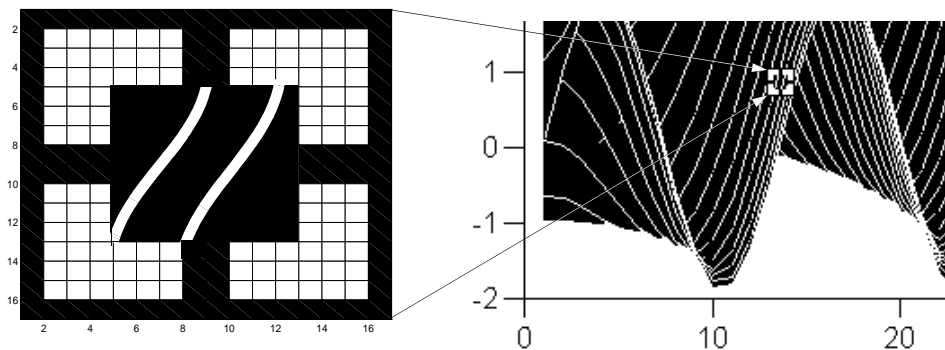

Creating Pointers from Functions. You can use a mathematical function to define the `PointerShapeCData` matrix. For example, evaluating the function

$$z = \sqrt{x^2 + y^2}$$

```

g = 0:.2:20;
[X,Y] = meshgrid(g);
Z = 2*sin(sqrt(X.^2 + Y.^2));
mesh(Z);

```

produces an interesting surface.

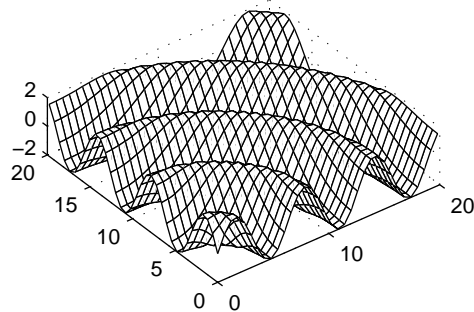

Use the values of Z to create a pointer sampling fewer points so that Z is a 16-by-16 matrix.

```

g = linspace(0,20,16);
[X,Y] = meshgrid(g);
Z = 2*sin(sqrt(X.^2 + Y.^2));
set(gcf, 'Pointer', 'custom', ...
        'PointerShapeCData', flipud((Z>0) + 1))

```

The statement `flipud((Z>0) + 1)` sets all values in Z that are greater than 0 to 2 (in MATLAB, `true + 1 = 2`), less than 0 to 1 (`false + 1 = 1`) and then flips the data around so that element (1,1) is the upper left corner.

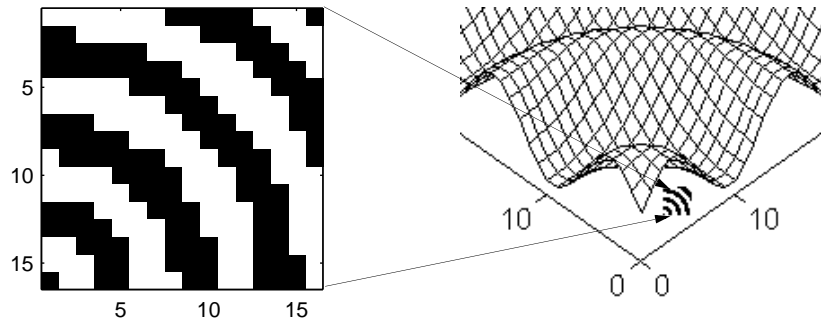

Axes Properties

Axes Objects — Defining Coordinate Systems for Graphs (p. 10-2)	What an axes is and what its properties are
Labeling and Appearance Properties (p. 10-3)	Properties that affect general appearance of the axes
Positioning Axes (p. 10-5)	How to use the axes <code>Position</code> property
Automatic Axes Resize (p. 10-7)	How axes are positioned within a figure
Multiple Axes per Figure (p. 10-13)	How to use axes to place text outside the graph axes and how to use multiple axes within a figure to achieve different views
Individual Axis Control (p. 10-16)	Properties that control the x -, y -, and z -axis individually
Using Multiple X- and Y-Axes (p. 10-22)	Multiple axes on a single graph
Automatic-Mode Properties (p. 10-25)	Properties that are set automatically with each graph
Colors Controlled by Axes (p. 10-28)	Axes colors and color limits (<code>caxis</code>) to control the mapping of data to colormaps

Axes Objects – Defining Coordinate Systems for Graphs

MATLAB uses graphics objects to create visual representations of data. For example, a two-dimensional array of numbers can be represented as lines connecting the data points defined by each column, as a surface constructed from a grid of rectangles whose vertices are defined by each element of the array, as a contour graph where equal values in the array are connected by lines, and so on.

In all these cases, there must be a frame of reference that defines where to place each data point on the graph. This frame of reference is the coordinate system defined by the axes. Axes orient and scale graphs to produce the view of the data that you see on screen.

MATLAB creates axes to define the coordinate system of each graph. Axes are always contained within a figure object and themselves contain the graphics objects that make up the graph.

Axes properties control many aspects of how MATLAB displays graphical information. This section discusses some of the features that are implemented through axes properties and provides examples of how to use these features.

The table in the axes reference page listing all axes properties provides an overview of the characteristics affected by these properties.

Labeling and Appearance Properties

MATLAB provides a number of properties for labeling and controlling the appearance of axes. For example, this surface plot shows some of the labeling possibilities and indicates the controlling property.

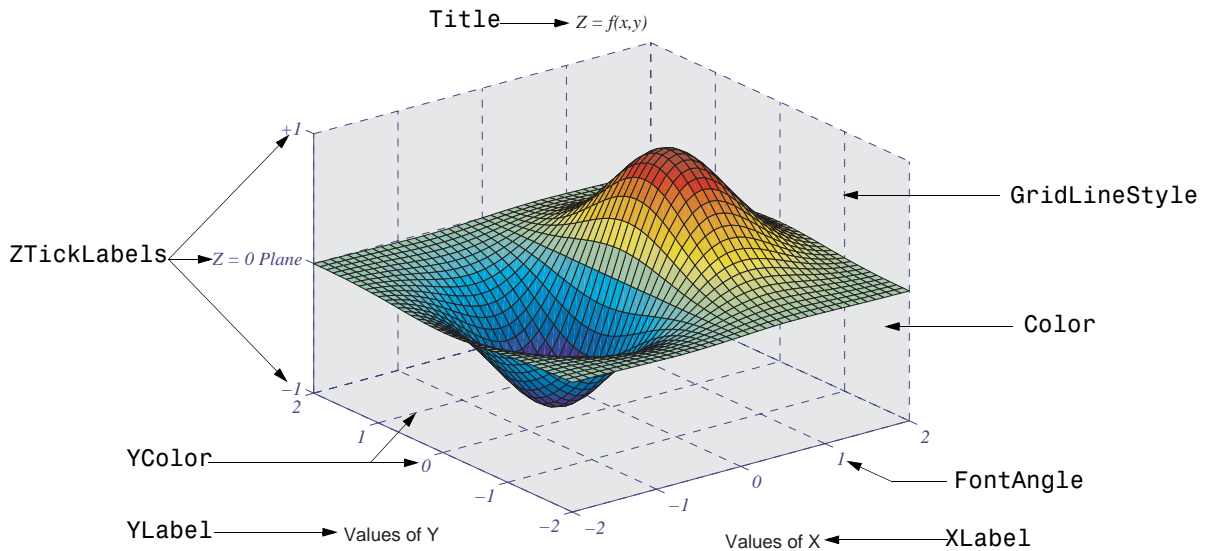

Creating Axes with Specific Characteristics

To create this axes, specify values for the indicated properties.

```
h = axes('Color',[.9 .9 .9],...
        'GridLineStyle','--',...
        'ZTickLabels','-1|Z = 0 Plane|+1',...
        'FontName','times',...
        'FontAngle','italic',...
        'FontSize',14,...
        'XColor',[0 0 .7],...
        'YColor',[0 0 .7],...
        'ZColor',[0 0 .7]);
```

Axis Labels

The individual axis labels are text objects whose handles are normally hidden from the command line (their `HandleVisibility` property is set to `callback`). You can use the `xlabel`, `ylabel`, `zlabel`, and `title` functions to create axis labels. However, these functions affect only the current axes. If you are labeling axes other than the current axes by referencing the axes handle, then you must obtain the text object handle from the corresponding axes property. For example,

```
get(axes_handle, 'XLabel')
```

returns the handle of the text object used as the x -axis label. Obtaining the text handle from the axes is useful in M-files and MATLAB-based applications where you cannot be sure the intended target is the current axes.

The following statements define the x - and y -axis labels and title for the axes above.

```
set(get(axes_handle, 'XLabel'), 'String', 'Values of X')
set(get(axes_handle, 'YLabel'), 'String', 'Values of Y')
set(get(axes_handle, 'Title'), 'String', '\fontname{times}\itZ =
f(x,y)')
```

Because the labels are text, you must specify a value for the `String` property, which is initially set to the empty string (i.e., there are no labels).

MATLAB overrides many of the other text properties to control positioning and orientation of these labels. However, you can set the `Color`, `FontAngle`, `FontName`, `FontSize`, `FontWeight`, and `String` properties.

Note that both axes objects and text objects have font specification properties. The call to the `axes` function on the previous page set values for the `FontName`, `FontAngle`, and `FontSize` properties. If you want to use the same font for the labels and title, specify these same property values when defining their `String` property. For example, the x -axis label statement would be

```
set(get(h, 'XLabel'), 'String', 'Values of X', ...
    'FontName', 'times', ...
    'FontAngle', 'italic', ...
    'FontSize', 14)
```

Positioning Axes

The axes `Position` property controls the size and location of an axes within a figure. The default axes has the same aspect ratio (ratio of width to height) as the default figure and fills most of the figure, leaving a border around the edges. However, you can define the axes position as any rectangle and place it wherever you want within a figure.

The Position Vector

MATLAB defines the axes `Position` property as a vector.

```
[left bottom width height]
```

`left` and `bottom` define a point in the figure that locates the lower left corner of the axes rectangle. `width` and `height` specify the dimensions of the axes rectangle. Viewing the axes in 2-D (azimuth = 0° , elevation = 90°) orients the x -axis horizontally and the y -axis vertically. From this angle, the plot box (the area used for plotting, exclusive of the axis labels) coincides with the axes rectangle.

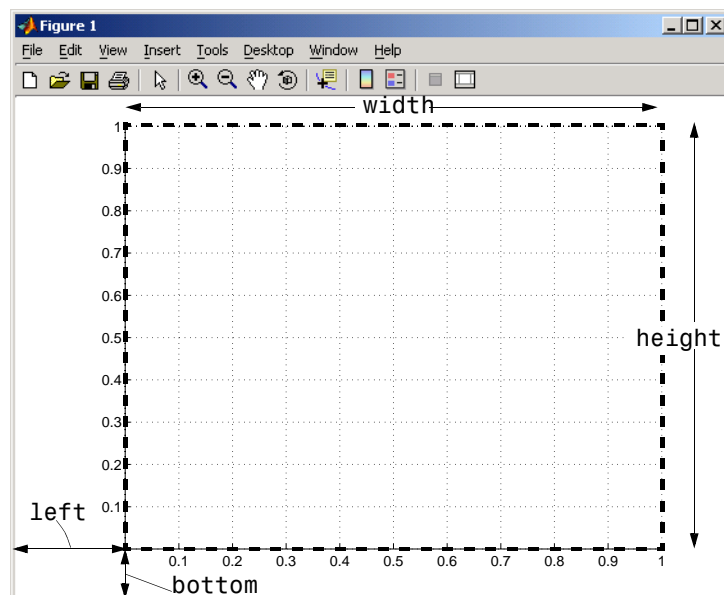

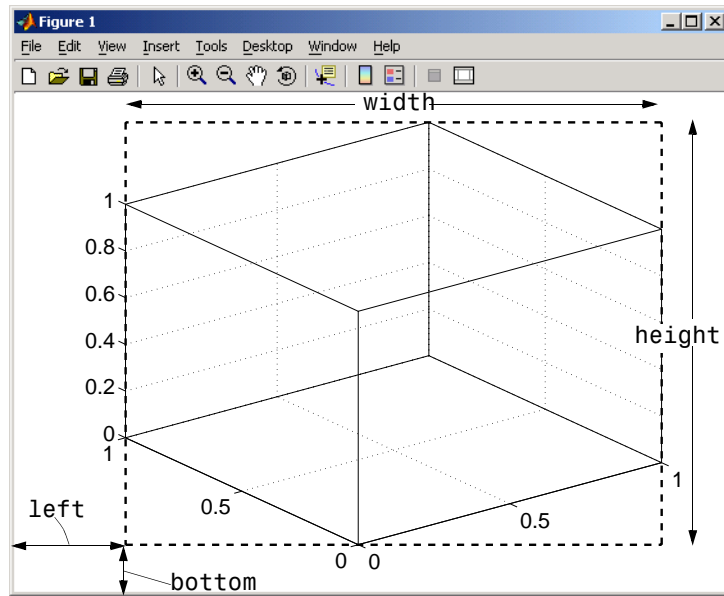

By default, MATLAB draws the plot box to fill the axes rectangle, regardless of its shape. However, axes properties enable control over the shape and scaling of the plot box.

Position Units

The axes `Units` property determines the units of measurement for the `Position` property. Possible values for this property are

```
set(gca, 'Units')
[ inches | centimeters | {normalized} | points | pixels ]
```

with `normalized` being the default. Normalized units map the lower left corner of the figure to the point (0,0) and the upper right corner to (1.0,1.0), regardless of the size of the figure. Normalized units cause axes to resize automatically whenever you resize the figure. All other units are absolute measurements that remained fixed as you resize the figure.

Automatic Axes Resize

When you create a graph, MATLAB automatically creates an axes to display the graph. The axes is sized to fit in the figure and automatically resizes as you resize the figure. Note, however, that MATLAB applies the automatic resize behavior only when the axes `Units` property is set to `normalized` (the default).

You can control the resize behavior of the axes using the following axes properties.

- `OuterPosition` — The boundary of the axes including the axis labels, title, and a margin. For figures with only one axes, this is the interior of the figure.
- `Position` — The boundary of the axes, excluding the tick marks and labels, title, and axis labels.
- `ActivePositionProperty` — Specifies whether to use the `OuterPosition` or the `Position` property as the size to preserve when resizing the figure containing the axes.
- `TightInset` — The margins added to the width and height of the `Position` property to include text labels, title, and axis labels.
- `Units` — Keep this property set to `normalized` to enable automatic axes resizing.

The following graph shows the areas defined by the `OuterPosition`, `TightInset + Position`, and `Position` properties.

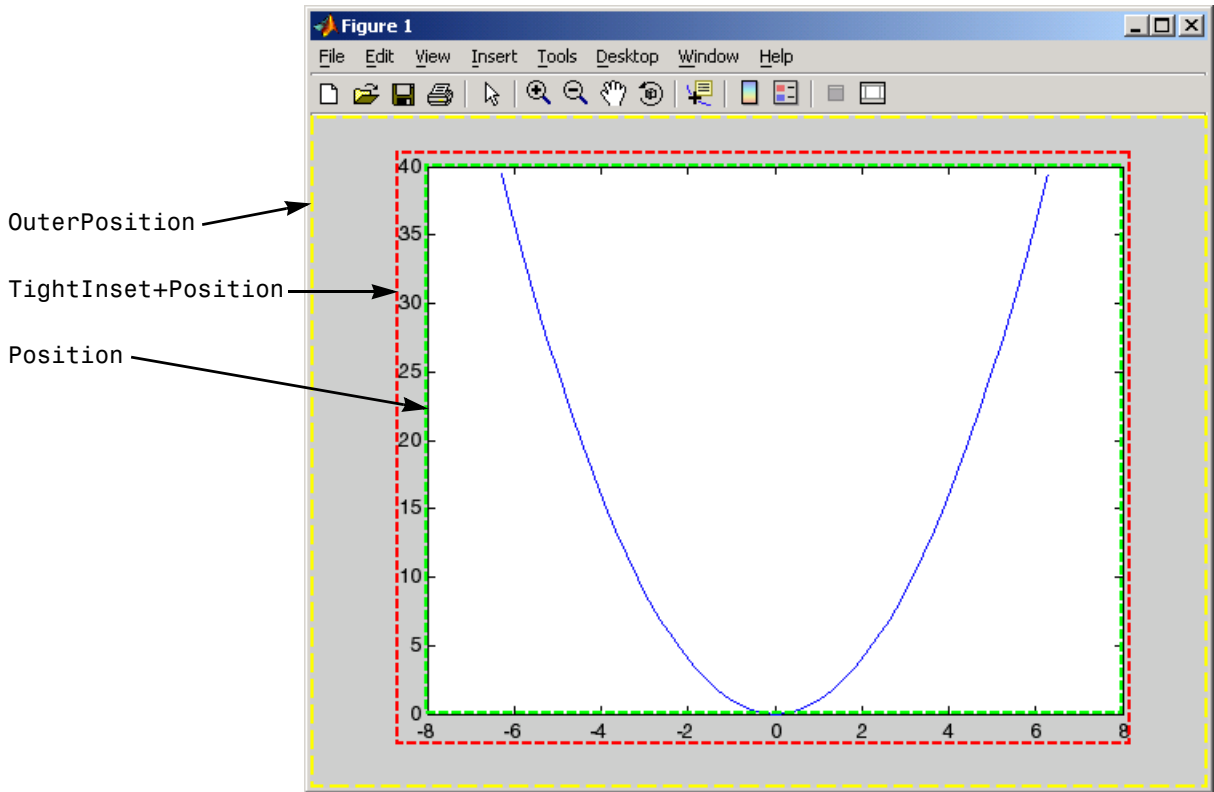

When you add axis labels and a title, the `TightInset` changes to accommodate the additional text, as shown in the following graph.

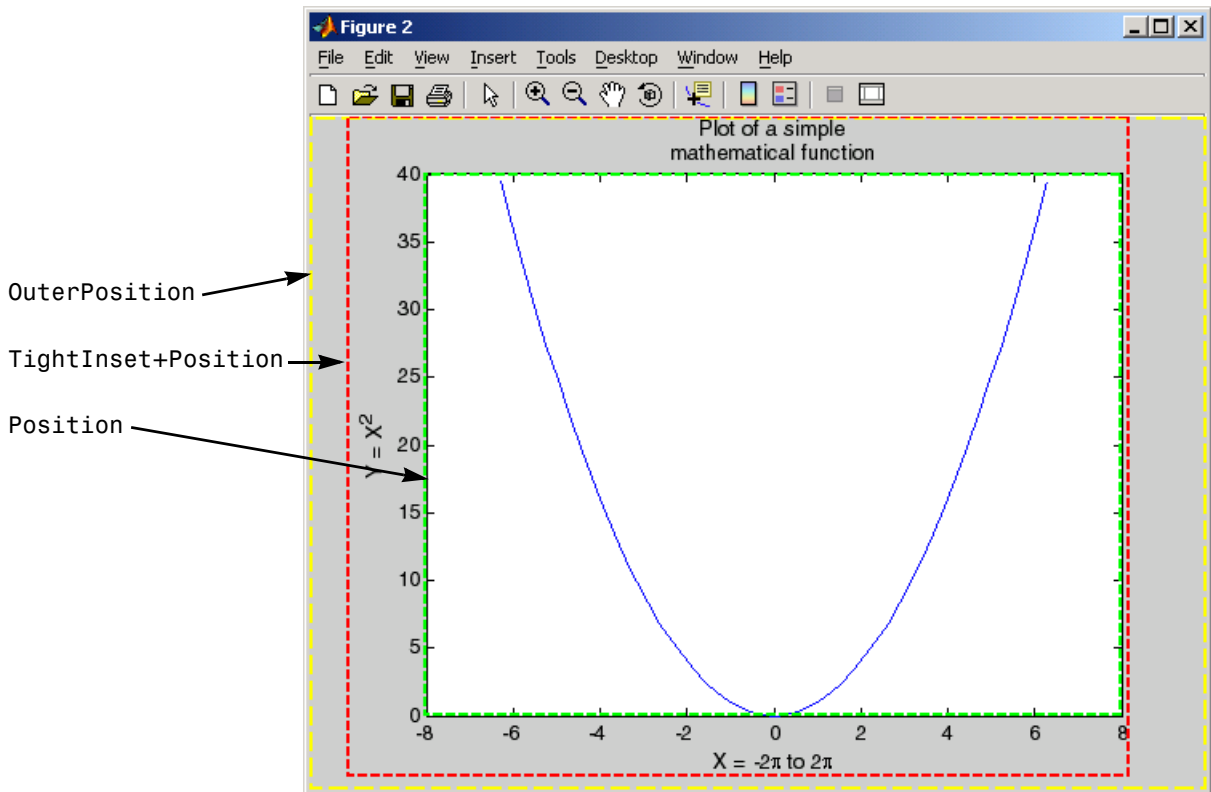

Now the size of the rectangle defined by the `TightInset + Position` properties includes all graph text. The `Position` and `OuterPosition` properties remain unchanged.

Using OuterPosition as the ActivePositionProperty

As you resize the figure, MATLAB maintains the area defined by the TightInset + Position so the test is not cut off. Compare the next two graphs, which have both been resized to the same figure size.

ActivePositionProperty = OuterPosition

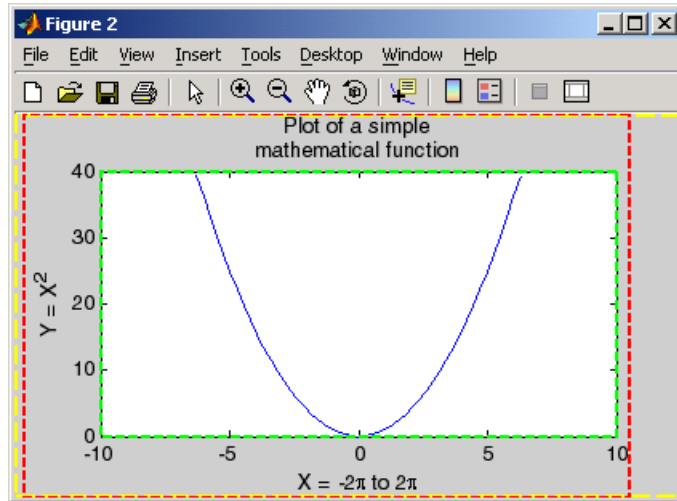

ActivePositionProperty = Position

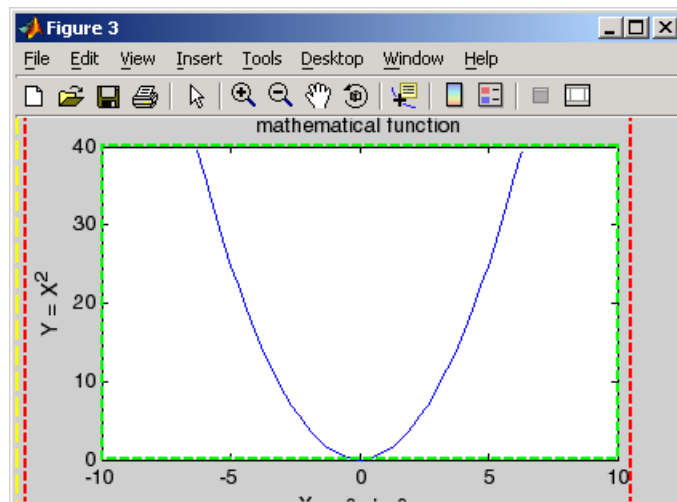

The following picture shows how these properties apply to 3-D graphs.

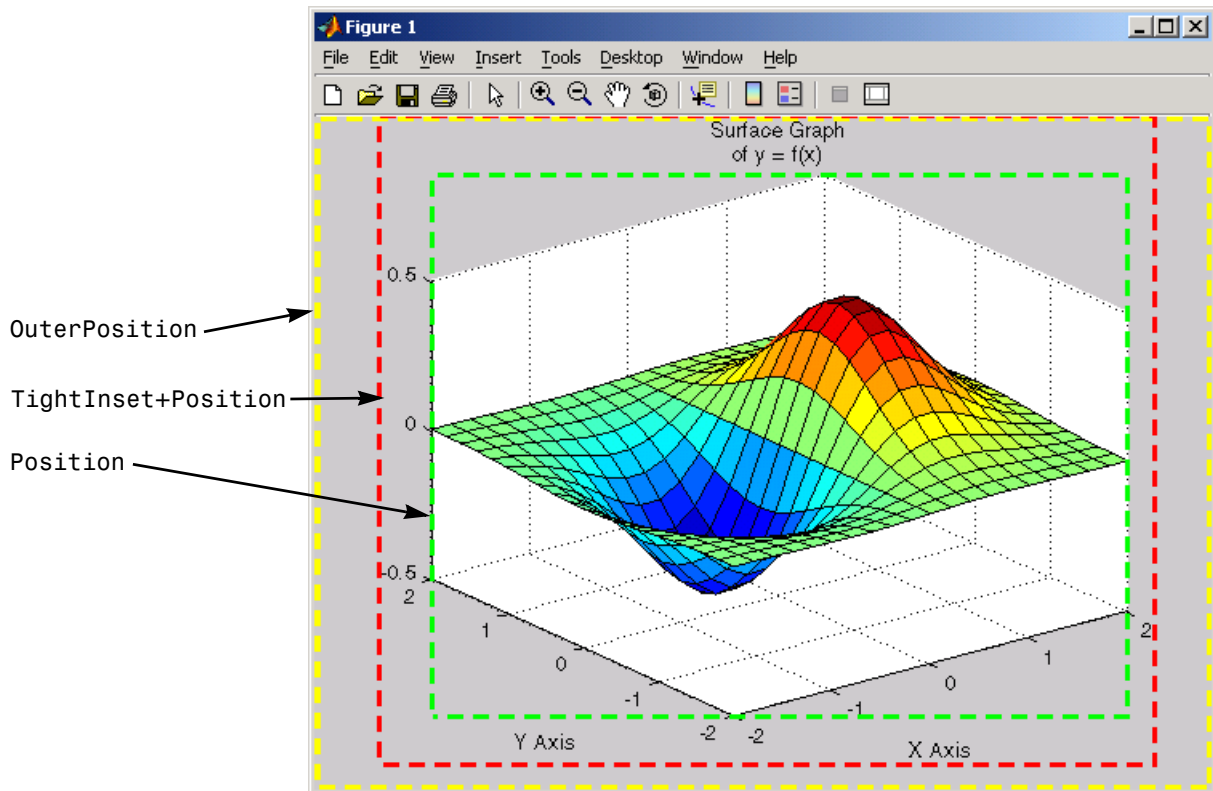

Axes Resizing in Subplots

Using the `OuterPosition` property as the `ActivePositionProperty` is an effective way to prevent titles and labels from being overwritten when there are multiple axes in a figure.

The following picture illustrates how MATLAB resizes the axes to accommodate the multiline titles on the lower two axes.

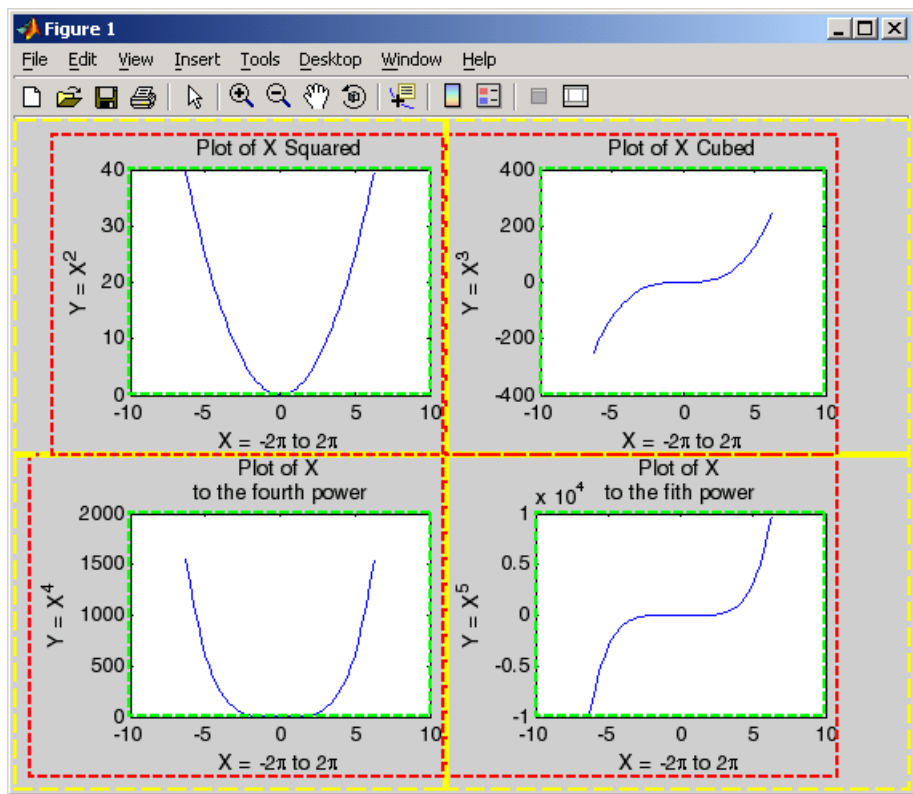

The default 3-D view is azimuth = -37.5° , elevation = 30° .

Multiple Axes per Figure

The `subplot` function creates multiple axes in one figure by computing values for `Position` that produce the specified number of axes.

The `subplot` function is useful for laying out a number of graphs equally spaced in the figure. However, overlapping axes can create some other useful effects. The following two sections provide examples:

- “Placing Text Outside the Axes” on page 10-13
- “Multiple Axes for Different Scaling” on page 10-14

Placing Text Outside the Axes

MATLAB always displays text objects within an axes. If you want to create a graph and provide a description of the information alongside the graph, you must create another axes to position the text. If you create an axes that is the same size as the figure and then create a smaller axes to draw the graph, you can then display text anywhere independently of the graph.

For example, define two axes.

```
h = axes('Position',[0 0 1 1],'Visible','off');
axes('Position',[.25 .1 .7 .8])
```

Because the axes units are normalized to the figure, specifying the `Position` as `[0 0 1 1]` creates an axes that encompasses the entire window.

Now plot some data in the current axes. The last axes created is the current axes, so MATLAB directs graphics output there.

```
t = 0:900;
plot(t,0.25*exp(-0.005*t))
```

Define the text and display it in the full-window axes.

```
str(1) = {'Plot of the function:'};
str(2) = {' y = A{\ite}^{\-\alpha{\\itt}}'};
str(3) = {'With the values:'};
str(3) = {' A = 0.25'};
str(4) = {' \alpha = .005'};
str(5) = {' t = 0:900'};
set(gcf,'CurrentAxes',h)
```

```
text(.025,.6,str,'FontSize',12)
```

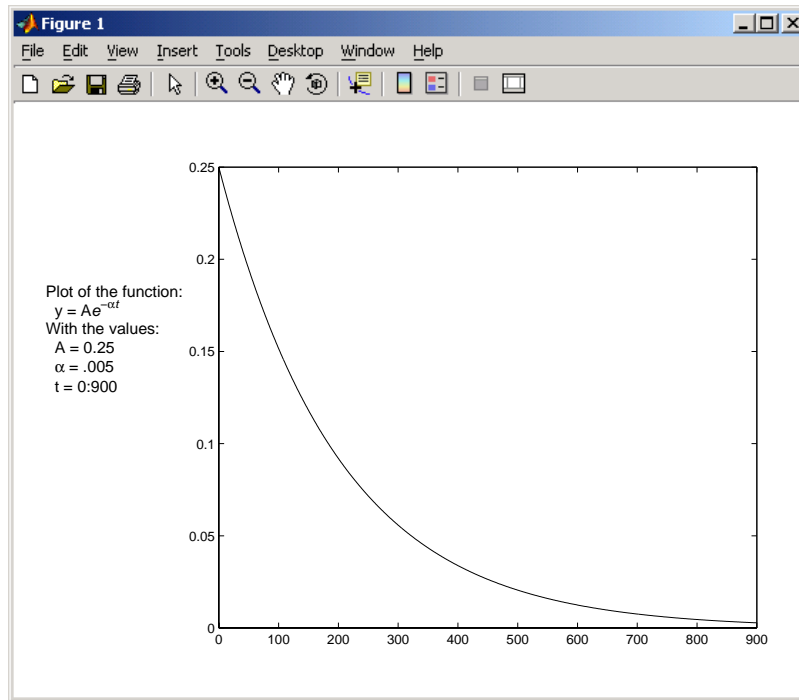

Multiple Axes for Different Scaling

You can create multiple axes to display graphics objects with different scaling without changing the data that defines these objects (which would be required to display them in a single axes).

```
h(1) = axes('Position',[0 0 1 1]);  
sphere  
h(2) = axes('Position',[0 0 .4 .6]);  
sphere  
h(3) = axes('Position',[0 .5 .5 .5]);  
sphere  
h(4) = axes('Position',[.5 0 .4 .4]);  
sphere  
h(5) = axes('Position',[.5 .5 .5 .3]);
```

```
sphere  
set(h,'Visible','off')
```

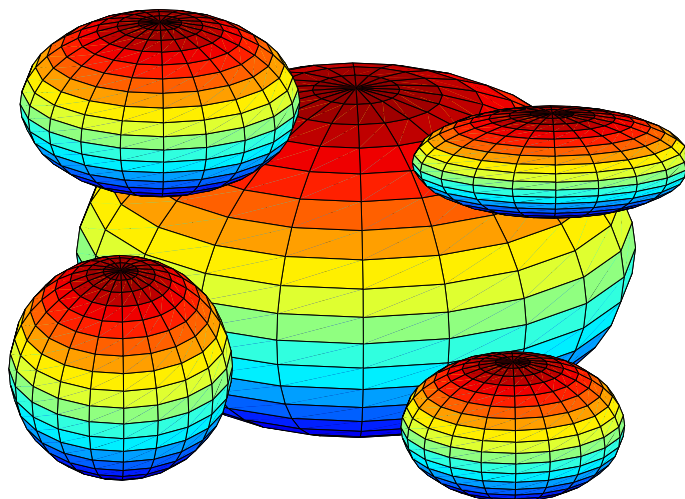

Each sphere is defined by the same data. However, because the parent axes occupy regions of different size and location, the spheres appear to be different sizes and shapes.

Individual Axis Control

MATLAB automatically determines axis limits, tick mark placement, and tick mark labels whenever you create a graph. However, you can specify these values manually by setting the appropriate property.

When you specify a value for a property controlled by a mode (e.g., the `XLim` property has an associated `XLimMode` property), MATLAB sets the mode to manual, enabling you to override automatic specification. Because the default values for these mode properties are automatic, calling high-level functions such as `plot` or `surf` resets these modes to `auto`.

This section discusses the following properties.

Property	Purpose
<code>XLim</code> , <code>YLim</code> , <code>ZLim</code>	Sets the axis range
<code>XLimMode</code> , <code>YLimMode</code> , <code>ZLimMode</code>	Specifies whether axis limits are determined automatically by MATLAB or specified manually by the user
<code>XTick</code> , <code>YTick</code> , <code>ZTick</code>	Sets the location of the tick marks along the axis
<code>XTickMode</code> , <code>YTickMode</code> , <code>ZTickMode</code>	Specifies whether tick mark locations are determined automatically by MATLAB or specified manually by the user
<code>XTickLabel</code> , <code>YTickLabel</code> , <code>ZTickLabel</code>	Specifies the labels for the axis tick marks
<code>XTickLabelMode</code> , <code>YTickLabelMode</code> , <code>ZTickLabelMode</code>	Specifies whether tick mark labels are determined automatically by MATLAB or specified manually by the user
<code>XDir</code> , <code>YDir</code> , <code>ZDir</code>	Sets the direction of increasing axis values

Setting Axis Limits

MATLAB determines the limits automatically for each axis based on the range of the data. You can override the selected limits by specifying the `XLim`, `YLim`, or `ZLim` property. For example, consider a plot of the function $Ae^{-\alpha t}$ evaluated with $A = 0.25$, $\alpha = 0.05$, and $t = 0$ to 900 .

```
t = 0:900;
plot(t,0.25*exp(-0.05*t))
```

The plot on the left shows the results. MATLAB selects axis limits that encompass the range of data in both x and y . However, because the plot contains little information beyond $t = 100$, changing the x -axis limits improves the usefulness of the plot. If the handle of the axes is `axes_handle`, then the following statement,

```
set(axes_handle, 'XLim', [0 100])
```

creates the plot on the right.

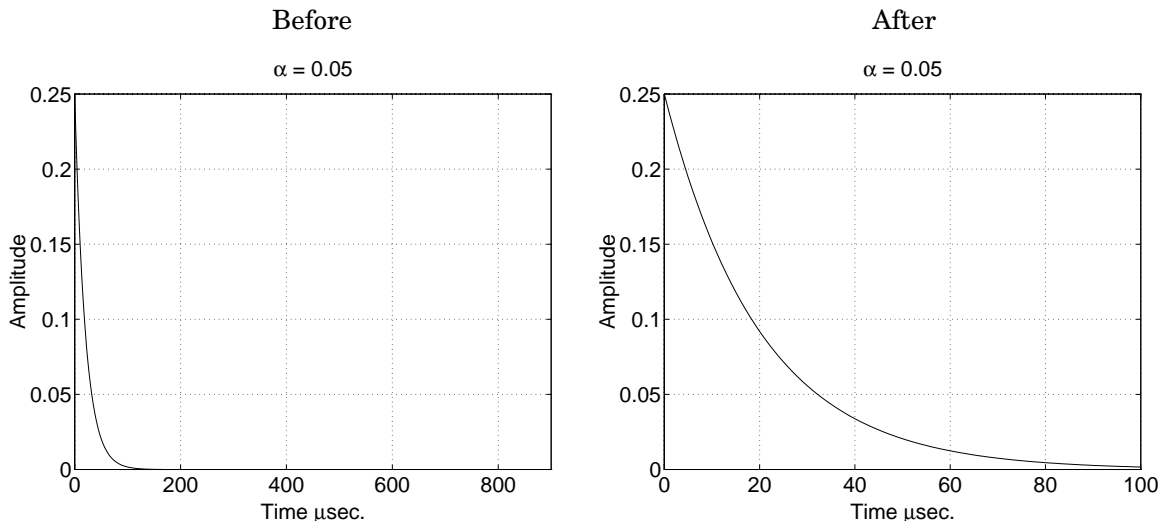

You can use the `axis` command to set limits on the current axes only.

Semiautomatic Limits

You can specify either the minimum or maximum value for an axis limit and allow the other limit to autorange. Do this by setting an explicit value for the manual limit and `Inf` for the automatic limit. For example, the statement

```
set(axes_handle, 'XLim', [0 Inf])
```

sets the `XLimMode` property to `auto` and allows MATLAB to determine the maximum value for `XLim`. Similarly, the statement

```
set(axes_handle, 'XLim', [-Inf 800])
```

sets the `XLimMode` property to `auto` and allows MATLAB to determine the minimum value for `XLim`.

Setting Tick Mark Locations

MATLAB selects the tick mark location based on the data range to produce equally spaced ticks (for linear graphs). You can specify alternative locations for the tick marks by setting the `XTick`, `YTick`, and `ZTick` properties.

For example, if the value 0.075 is of interest for the amplitude of the function $Ae^{-\alpha t}$, specify tick marks to include that value.

```
set(gca, 'YTick', [0 0.05 0.075 0.1 0.15 0.2 0.25])
```

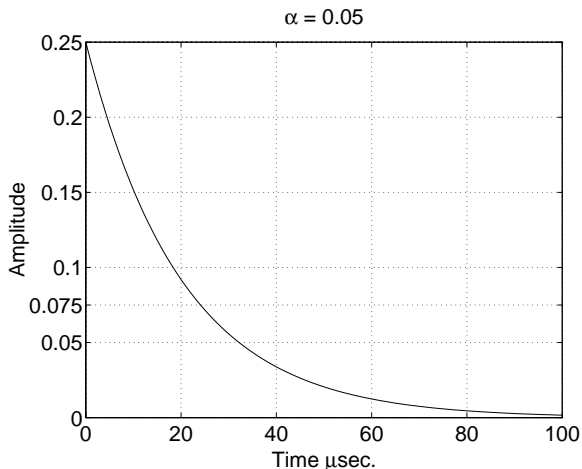

You can change tick labeling from numbers to strings using the `XTickLabel`, `YTickLabel`, and `ZTickLabel` properties.

For example, to label the y -axis value of 0.075 with the string `Cutoff`, you can specify all y -axis labels as a string, separating each label with the “|” character.

```
set(gca, 'YTickLabel', '0|0.05|Cutoff|0.1|0.15|0.2|0.25')
```

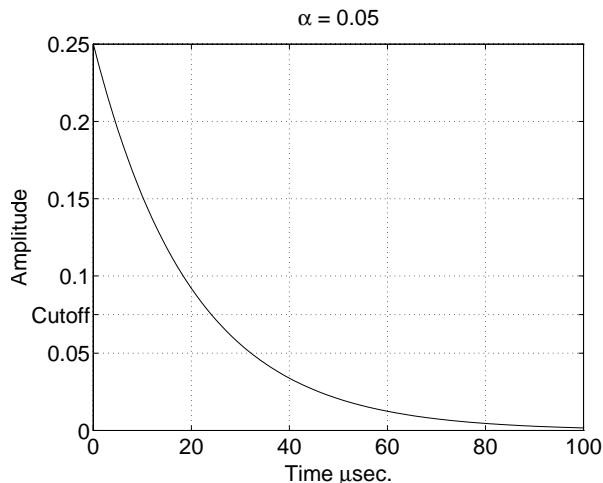

Changing Axis Direction

The `XDir`, `YDir`, and `ZDir` properties control the direction of increasing values on the respective axis. In the default 2-D view, the x -axis values increase from left to right and the y -axis values increase from bottom to top. The z -axis points out of the screen.

You can change the direction of increasing values by setting the associated property to reverse. For example, setting `XDir` to reverse,

```
set(gca, 'XDir', 'reverse')
```

produces a plot whose x -axis decreases from left to right.

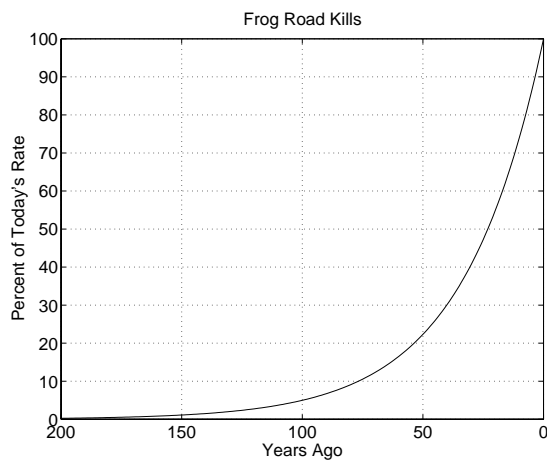

In the 3-D view, the y -axis increases from front to back and the z -axis increases from bottom to top.

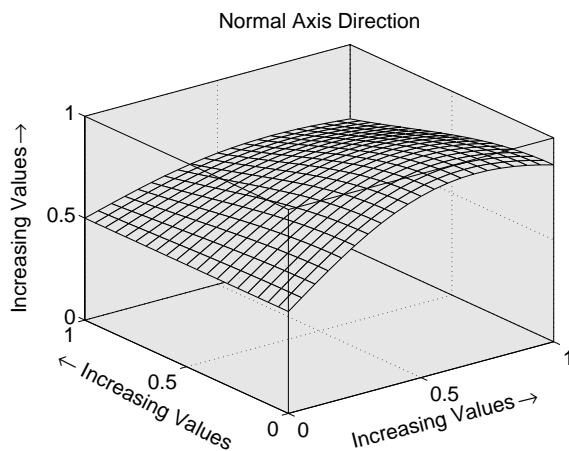

Setting the x -, y -, and z -directions to reverse,

```
set(gca, 'XDir', 'rev', 'YDir', 'rev', 'ZDir', 'rev')
```

yields

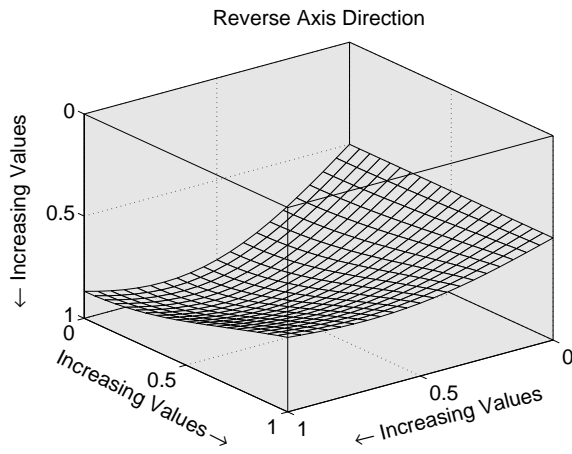

Using Multiple X- and Y-Axes

The `XAxisLocation` and `YAxisLocation` properties specify on which side of the graph to place the x - and y -axes. You can create graphs with two different x -axes and y -axes by superimposing two axes objects and using `XAxisLocation` and `YAxisLocation` to position each axis on a different side of the graph. This technique is useful to plot different sets of data with different scaling in the same graph.

Example – Double Axis Graphs

This example creates a graph to display two separate sets of data using the bottom and left sides as the x - and y -axis for one, and the top and right sides as the x - and y -axis for the other.

Using low-level line and axes routines allows you to superimpose objects easily. Plot the first data, making the color of the line and the corresponding x - and y -axis the same to more easily associate them.

```
h11 = line(x1,y1,'Color','r');
ax1 = gca;
set(ax1,'XColor','r','YColor','r')
```

Next, create another axes at the same location as the first, placing the x -axis on top and the y -axis on the right. Set the axes `Color` to `none` to allow the first axes to be visible and color code the x - and y -axis to match the data.

```
ax2 = axes('Position',get(ax1,'Position'),...
          'XAxisLocation','top',...
          'YAxisLocation','right',...
          'Color','none',...
          'XColor','k','YColor','k');
```

Draw the second set of data in the same color as the x - and y -axis.

```
h12 = line(x2,y2,'Color','k','Parent',ax2);
```

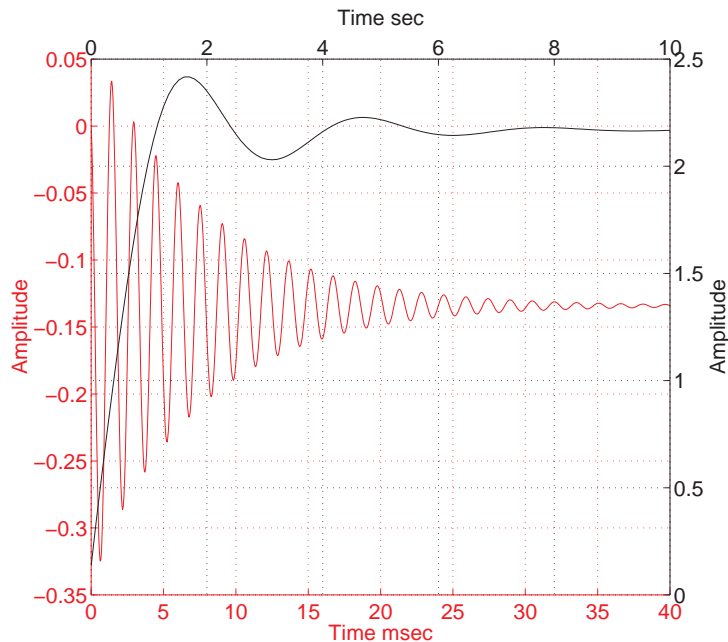

Creating Coincident Grids

Since the two axes are completely independent, MATLAB determines tick mark locations according to the data plotted in each. It is unlikely the gridlines will coincide. This produces a somewhat confusing looking graph, even though the two grids are drawn in different colors. However, if you manually specify tick mark locations, you can make the grids coincide.

The key is to specify the same number of tick marks along corresponding axis lines (it is also necessary for both axes to be the same size). The following graph of the same data uses six tick marks per axis, equally spaced within the original limits. To calculate the tick mark locations, obtain the limits of each axis and calculate an increment.

```
xlimits = get(ax1,'XLim');
ylimits = get(ax1,'YLim');
xinc = (xlimits(2)-xlimits(1))/5;
yinc = (ylimits(2)-ylimits(1))/5;
```

Now set the tick mark locations.

```
set(ax1, 'XTick', [xlims(1):xinc:xlims(2)], ...  
      'YTick', [ylims(1):yinc:ylims(2)])
```

The resulting graph is visually simpler, even though the y-axis on the left has rather odd tick mark values.

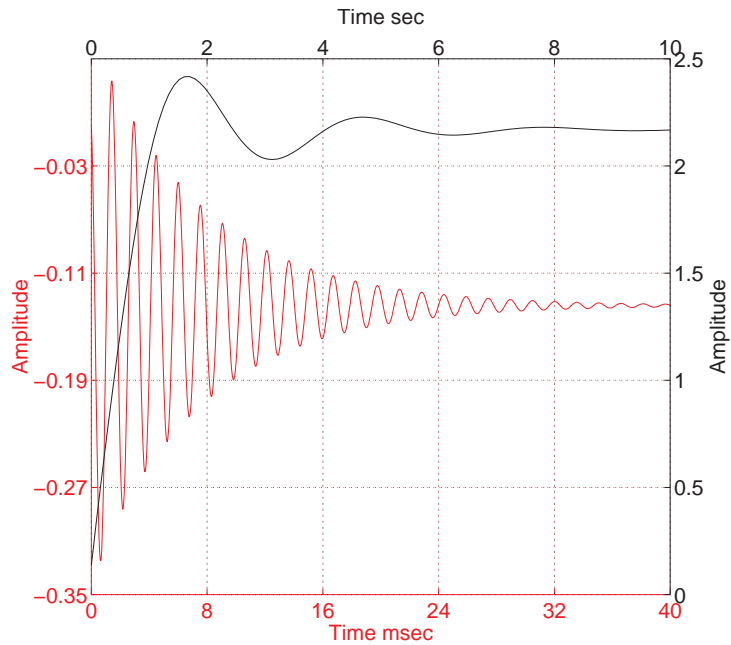

Automatic-Mode Properties

While object creation routines that create axes children do not explicitly change axes properties, some axes properties are under automatic control when their associated mode property is set to auto (which is the default). The following table lists the automatic-mode properties.

Mode Property	What It Controls
CameraPositionMode	Positioning of the viewpoint
CameraTargetMode	Positioning of the camera target in the axes
CameraUpVectorMode	The direction of “up” in 2-D and 3-D views
CameraViewAngleMode	The size of the projected scene and stretch-to-fit behavior
CLimMode	Mapping of data values to colors
DataAspectRatioMode	Relative scaling of data units along x -, y -, and z -axes and stretch-to-fit behavior
PlotBoxAspectRatioMode	Relative scaling of plot box along x -, y -, and z -axes and stretch-to-fit behavior
TickDirMode	Direction of axis tick marks (in for 2-D, out for 3-D)
XLimMode YLimMode ZLimMode	Limits of the respective x , y , and z axes
XTickMode YTickMode ZTickMode	Tick mark spacing along the respective x -, y -, and z -axes
XTickLabelMode YTickLabelMode ZTickLabelMode	Tick mark labels along the respective x -, y -, and z -axes

For example, if all property values are set to their defaults and you enter these statements,

```
line(1:10,1:10)
line(1:10,[1:10].^2)
```

the second line statement causes the `YLim` property to change from `[0 10]` to `[0 100]`.

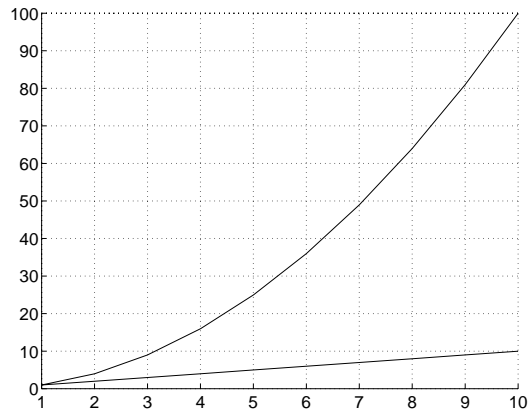

This is because `YLimMode` is `auto`, which always causes MATLAB to recompute the axis limits.

If you set the value controlled by an automatic-mode property, MATLAB sets the mode to `manual` and does not automatically recompute the value.

For example, in the statements

```
line(1:10,1:10)
set(gca,'XLim',[1 10],'YLim',[1 20])
line(1:10,[1:10].^2)
```

the `set` statement sets the x - and y -axis limits *and* changes the `XLimMode` and `YLimMode` properties to `manual`. The second line statement now draws a line that is clipped to the axis limits `[1 12]` instead of causing the axes to recompute its limits.

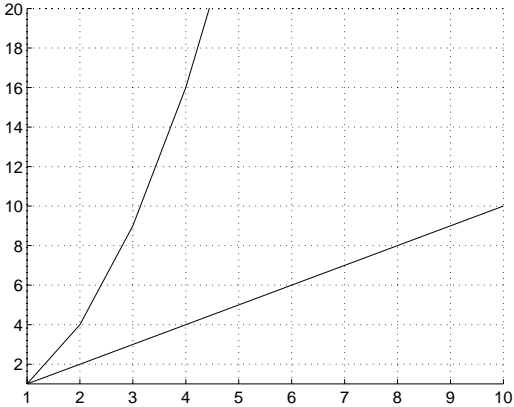

Colors Controlled by Axes

Axes properties specify the color of the axis lines, tick marks, labels, and the background. Properties also control the colors of the lines drawn by plotting routines and how image, patch, and surface objects obtain colors from the figure colormap.

The axes properties discussed in this section are listed in the following table.

Property	Characteristic it Controls
Color	Axes background color
XColor, YColor, ZColor	Color of the axis lines, tick marks, gridlines, and labels
Title	Title text object handles
XLabel, YLabel, ZLabel	Axis label text object handles
CLim	Controls mapping of graphic object CData to the figure colormap
CLimMode	Automatic or manual control of CLim property
ColorOrder	Line color autcycle order
LineStyleOrder	Line styles autcycle order (not a color, but related to ColorOrder)

Specifying Axes Colors

The default axes background color is set up by the `colordef` command, which is called in your startup file. However, you can easily define your own color scheme.

Changing the Color Scheme

Suppose you want an axes to use a “black-on-white” color scheme. First, change the background to white and the axis lines, grid, tick marks, and tick mark labels to black.

```
set(gca, 'Color', 'w', ...
```

```
'XColor', 'k', ...
'YColor', 'k', ...
'ZColor', 'k')
```

Next, change the color of the text objects used for the title and axis labels.

```
set(get(gca, 'Title'), 'Color', 'k')
set(get(gca, 'XLabel'), 'Color', 'k')
set(get(gca, 'YLabel'), 'Color', 'k')
set(get(gca, 'ZLabel'), 'Color', 'k')
```

Changing the figure background color to white completes the new color scheme.

```
set(gcf, 'Color', 'w')
```

When you are done, a figure containing a mesh plot looks like the following figure.

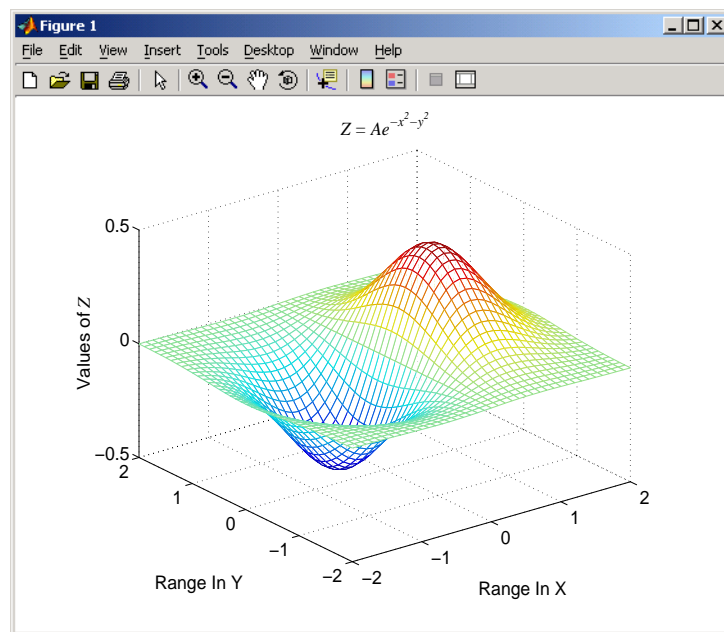

You can define default values for the appropriate properties and put these definitions in your `startup.m` file. Titles and axis labels are text objects, so you must set a default color for all text objects, which is a good idea anyway because

the default text color of white is not visible on the white background. Lines created with the low-level line function (but not the plotting routines) also have a default color of white, so you should change the default line color as well.

To set default values on the root level, use

```
set(0, 'DefaultFigureColor', 'w'  
      'DefaultAxesColor', 'w', ...  
      'DefaultAxesXColor', 'k', ...  
      'DefaultAxesYColor', 'k', ...  
      'DefaultAxesZColor', 'k', ...  
      'DefaultTextColor', 'k', ...  
      'DefaultLineColor', 'k')
```

MATLAB colors other axes children (i.e., image, patch, and surface objects) according to the values of their CData properties and the figure colormap.

Axes Color Limits – the CLim Property

Many of the 3-D graphics functions produce graphs that use color as another data dimension. For example, surface plots map surface height to color. The color limits control the limits of the color dimension in a way analogous to setting axis limits.

The axes CLim property controls the mapping of image, patch, and surface CData to the figure colormap. CLim is a two-element vector [cmin cmax] specifying the CData value to map to the first color in the colormap (cmin) and the CData value to map to the last color in the colormap (cmax). Data values in between are linearly transformed from the second to the next to last color, using the expression

$$\text{colormap_index} = \text{fix}((\text{CData} - \text{cmin}) / (\text{cmax} - \text{cmin}) * \text{cm_length}) + 1$$

cm_length is the length of the colormap. When CLimMode is auto, MATLAB sets CLim to the range of the CData of all graphics objects within the axes. However, you can set CLim to span any range of values. This allows individual axes within a single figure to use different portions of the figure's colormap. You can create colormaps with different regions, each used by a different axes.

See the caxis command for more information on color limits.

See “Example — Simulating Multiple Colormaps in a Figure” on page 10-31 for an example that calculates color limits.

Example – Simulating Multiple Colormaps in a Figure

Suppose you want to display two different surfaces in the same figure and color each surface with a different colormap. You can produce the effect of two different colormaps by concatenating two colormaps and then setting the `CLim` property of each axes to map into a different portion of the colormap.

This example creates two surfaces from the same topographic data. One uses the color scheme of a typical atlas — shades of blue for the ocean and greens for the land. The other surface is illuminated with a light source to create the illusion of a three-dimensional picture. Such illumination requires a colormap that changes monotonically from dark to light.

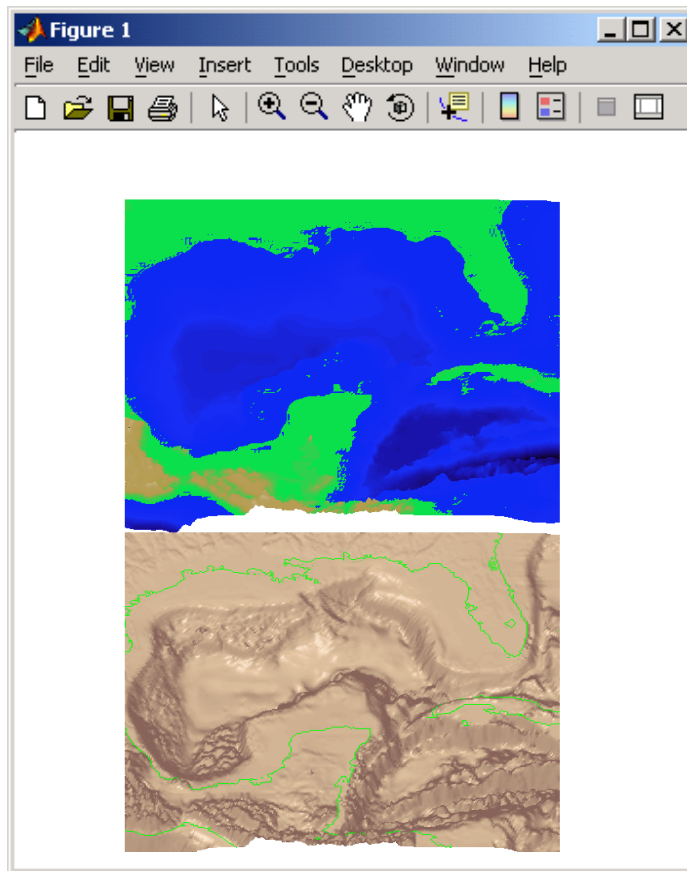

Calculating Color Limits

The key to this example is calculating values for `CLim` that cause each surface to use the section of the colormap containing the appropriate colors.

To calculate the new values for `CLim`, you need to know

- The total length of the colormap (`CmLength`)
- The beginning colormap slot to use for each axes (`BeginSlot`)
- The ending colormap slot to use for each axes (`EndSlot`)

- The minimum and maximum CData values of the graphic objects contained in the axes. That is, the values of the axes CLim property determined by MATLAB when CLimMode is auto (CDmin and CDmax).

First, define subplot regions and plot the surfaces.

```
ax1 = subplot(2,1,1);
view([0 80])
surf(topodata)
shading interp
ax2 = subplot(2,1,2),;
view([0 80]);
surf1(topodata,[60 0])
shading interp
```

Concatenate two colormaps and install the new colormap.

```
colormap([Lightingmap;Atlasmap]);
```

Obtain the data you need to calculate new values for CLim.

```
CmLength   = size(get(gcf,'Colormap'),1);% Colormap length
BeginSlot1 = 1;           % Beginning slot
EndSlot1   = size(Lightingmap,1); % Ending slot
BeginSlot2 = EndSlot1+1;
EndSlot2   = CmLength;
CLim1      = get(ax1,'CLim');% CLim values for each axis
CLim2      = get(ax2,'CLim');
```

Defining a Function to Calculate CLim Values

Computing new values for CLim involves determining the portion of the colormap you want each axes to use relative to the total colormap size and scaling its CLim range accordingly. You can define a MATLAB function to do this.

```
function CLim = newclim(BeginSlot,EndSlot,CDmin,CDmax,CmLength)
%           Convert slot number and range
%           to percent of colormap
PBeginSlot = (BeginSlot - 1) / (CmLength - 1);
PEndSlot   = (EndSlot - 1) / (CmLength - 1);
PCmRange    = PEndSlot - PBeginSlot;
%           Determine range and min and max
```

```

%           of new CLim values
DataRange = CDmax - CDmin;
ClimRange = DataRange / PCmRange;
NewCmin   = CDmin - (PBeginSlot * ClimRange);
NewCmax   = CDmax + (1 - PEndSlot) * ClimRange;
CLim      = [NewCmin, NewCmax];

```

The input arguments are identified in the bulleted list above. The M-file first computes the percentage of the total colormap you want to use for a particular axes (PCmRange) and then computes the CLim range required to use that portion of the colormap given the CData range in the axes. Finally, it determines the minimum and maximum values required for the calculated CLim range and returns these values. These values are the color limits for the given axes.

Using the Function

Use the `newclim` M-file to set the CLim values of each axes. The statement

```
set(ax1, 'CLim', newclim(65, 120, clim1(1), clim1(2)))
```

sets the CLim values for the first axes so the surface uses color slots 65 to 120. The lit surface uses the lower 64 slots. You need to reset its CLim values as well.

```
set(ax2, 'CLim', newclim(1, 64, clim1(1), clim1(2)))
```

How the Function Works

MATLAB enables you to specify any values for the axes CLim property, even if these values do not correspond to the CData of the graphics objects displayed in the axes. MATLAB always maps the minimum CLim value to the first color in the colormap and the maximum CLim value to the last color in the colormap, whether or not there are really any CData values corresponding to these colors. Therefore, if you specify values for CLim that extend beyond the object's actual CData minimum and maximum, MATLAB colors the object with only a subset of the colormap.

The `newclim` M-file computes values for CLim that map the graphics object's actual CData values to the beginning and ending colormap slots you specify. It does this by defining a "virtual" graphics object having the computed CLim values. The following picture illustrates this concept. It shows a side view of two surfaces to make it easier to visualize the mapping of color to surface topography. The virtual surface is on the left and the actual surface on the right. In the center is the figure's colormap.

The real surface has `CLim` values of $[0.4 \ -0.4]$. To color this surface with slots 65 to 120, `newclim` computed new `CLim` values of $[0.4 \ -1.4269]$. The virtual surface on the left represents these values.

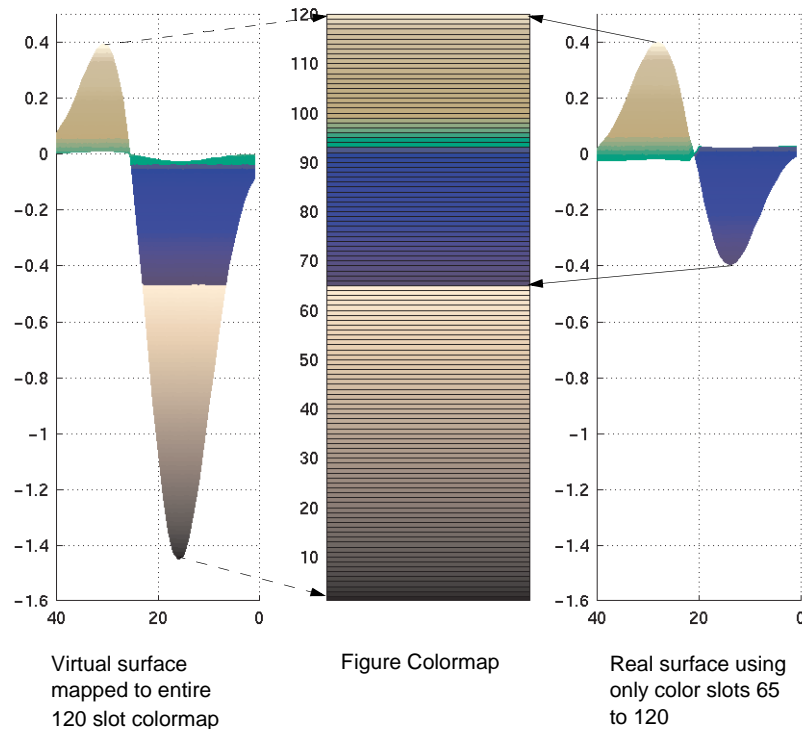

Defining the Color of Lines for Plotting

The axes `ColorOrder` property determines the color of the individual lines drawn by the `plot` and `plot3` functions. For multiline graphs, these functions cycle through the colors defined by `ColorOrder`, repeating the cycle when they reach the end of the list.

The `colordef` command defines various color order schemes for different background colors. `colordef` is typically called in the `matlabrc` file, which is executed during MATLAB startup.

Defining Your Own ColorOrder

You can redefine `ColorOrder` to be any m -by-3 matrix of RGB values, where m is the number of colors. However, high-level functions like `plot` and `plot3` reset most axes properties (including `ColorOrder`) to the defaults each time you call them. To use your own `ColorOrder` definition you must do one of the following three things:

- Define a default `ColorOrder` on the figure or root level
- Change the axes `NextPlot` property to add or replace children
- Use the informal form of the line function, which obeys the `ColorOrder` but does not clear the axes or reset properties

Changing the Default ColorOrder. You can define a new `ColorOrder` that MATLAB uses within a particular figure, for all axes within any figures created during the MATLAB session, or as a user-defined default that MATLAB always uses.

To change the `ColorOrder` for all plots in the current figure, set a default in that figure. For example, to set `ColorOrder` to the colors red, green, and blue, use the statement

```
set(gcf, 'DefaultAxesColorOrder', [1 0 0; 0 1 0; 0 0 1])
```

To define a new `ColorOrder` that MATLAB uses for all plotting during your entire MATLAB session, set a default on the root level so axes created in any figure use your defaults.

```
set(0, 'DefaultAxesColorOrder', [1 0 0; 0 1 0; 0 0 1])
```

To define a new `ColorOrder` that MATLAB always uses, place the previous statement in your `startup.m` file.

Setting the NextPlot Property. The axes `NextPlot` property determines how high-level graphics functions draw into an existing axes. You can use this property to prevent `plot` and `plot3` from resetting the `ColorOrder` property each time you call them, but still clear the axes of any existing plots.

By default, `NextPlot` is set to `replace`, which is equivalent to a `cla reset` command (i.e., delete all axes children and reset all properties, except `Position`, to their defaults). If you set `NextPlot` to `replacechildren`,

```
set(gca, 'NextPlot', 'replacechildren')
```

MATLAB deletes the axes children, but does not reset axes properties. This is equivalent to a `cla` command without the `reset`.

After setting `NextPlot` to `replacechildren`, you can redefine the `ColorOrder` property and call `plot` and `plot3` without affecting the `ColorOrder`.

Setting `NextPlot` to `add` is the equivalent of issuing the `hold on` command. This setting prevents MATLAB from resetting the `ColorOrder` property, but it does not clear the axes children with each call to a plotting function.

Using the line Function. The behavior of the `line` function depends on its calling syntax. When you use the informal form (which does not include any explicit property definitions),

```
line(x,y,z)
```

`line` obeys the `ColorOrder` property, but does not clear the axes with each invocation or change the view to 3-D (as `plot3` does). However, `line` can be useful for creating your own plotting functions where you do not want the automatic behavior of `plot` or `plot3`, but you do want multiline graphs to use a particular `ColorOrder`.

Line Styles Used for Plotting – `LineStyleOrder`

The axes `LineStyleOrder` property is analogous to the `ColorOrder` property. It specifies the line styles to use for multiline plots created with the `plot` and `plot3` functions. MATLAB increments the line style only after using all of the colors in the `ColorOrder` property. It then uses all the colors again with the second line style, and so on.

For example, define a default `ColorOrder` of red, green, and blue and a default `LineStyleOrder` of solid, dashed, and dotted lines.

```
set(0,'DefaultAxesColorOrder',[1 0 0;0 1 0;0 0 1],...
    'DefaultAxesLineStyleOrder','-|--|:')
```

Then plot some multiline data.

```
t = 0:pi/20:2*pi;
a = ones(length(t),9);
for i = 1:9
    a(:,i) = sin(t-i/5)';
end
plot(t,a)
```

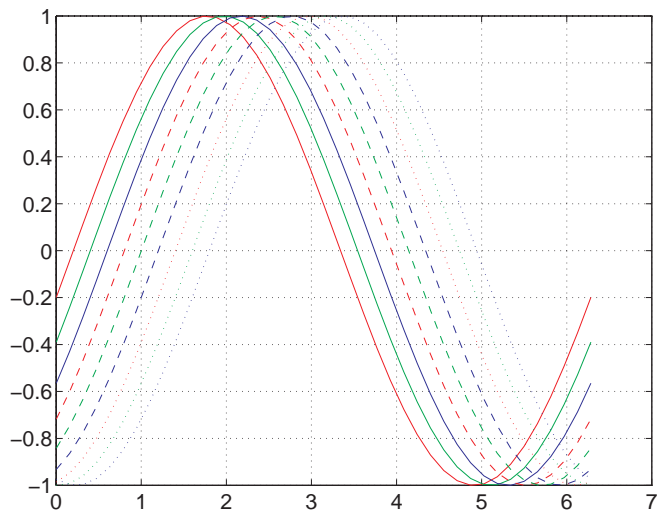

MATLAB cycles through all colors for each line style.

3-D Visualization

This section discusses visualization techniques and illustrates the application of these techniques to specific types of data.

Creating 3-D Graphs	3-D line and surface graphs
Defining the View	Control camera, zooming, projection, compose a scene, control the aspect ratio of the axes
Lighting as a Visualization Tool	Lighting effects you can employ to add realism and improve shape definition in 3-D views
Transparency	Various techniques for making objects translucent
Creating 3-D Models with Patches	Define 3-D shell representations of physical shapes using patch objects
Volume Visualization Techniques	Visualize gridded 3-D volume data (both scalar and vector)

Related Information

The following section provides information that is useful in understanding the techniques described in this section.

Graphics	MATLAB plotting tools, standard plotting functions, graph printing and annotation. Also graphic object properties.
----------	--

Creating 3-D Graphs

A Typical 3-D Graph (p. 11-2)

The steps to follow to create a typical 3-D graph

Line Plots of 3-D Data (p. 11-3)

Line plots of data having x -, y -, and z -coordinates

Representing a Matrix as a Surface
(p. 11-5)

Graphing matrix (2-D array) data on a rectangular grid

Coloring Mesh and Surface Plots
(p. 11-13)

Techniques for coloring surface and mesh plots, including colormaps, truecolor, and texture mapping

A Typical 3-D Graph

This table illustrates typical steps involved in producing 3-D scenes containing either data graphs or models of 3-D objects. Example applications include pseudocolor surfaces illustrating the values of functions over specific regions and objects drawn with polygons and colored with light sources to produce realism. Usually, you follow either step 4 or step 5.

Step	Typical Code
1 Prepare your data.	<code>Z = peaks(20);</code>
2 Select window and position plot region within window.	<code>figure(1) subplot(2,1,2)</code>
3 Call 3-D graphing function.	<code>h = surf(Z);</code>
4 Set colormap and shading algorithm.	<code>colormap hot shading interp set(h, 'EdgeColor', 'k')</code>
5 Add lighting.	<code>light('Position', [-2,2,20]) lighting phong material([0.4,0.6,0.5,30]) set(h, 'FaceColor', [0.7 0.7 0], ... 'BackFaceLighting', 'lit')</code>
6 Set viewpoint.	<code>view([30,25]) set(gca, 'CameraViewAngleMode', 'Manual')</code>
7 Set axis limits and tick marks.	<code>axis([5 15 5 15 -8 8]) set(gca, 'ZTickLabel', 'Negative Positive')</code>
8 Set aspect ratio.	<code>set(gca, 'PlotBoxAspectRatio', [2.5 2.5 1])</code>
9 Annotate the graph with axis labels, legend, and text.	<code>xlabel('X Axis') ylabel('Y Axis') zlabel('Function Value') title('Peaks')</code>
10 Print graph.	<code>set(gcf, 'PaperPositionMode', 'auto') print -dps2</code>

Line Plots of 3-D Data

The 3-D analog of the `plot` function is `plot3`. If `x`, `y`, and `z` are three vectors of the same length,

```
plot3(x,y,z)
```

generates a line in 3-D through the points whose coordinates are the elements of `x`, `y`, and `z` and then produces a 2-D projection of that line on the screen. For example, these statements produce a helix.

```
t = 0:pi/50:10*pi;  
plot3(sin(t),cos(t),t)  
axis square; grid on
```

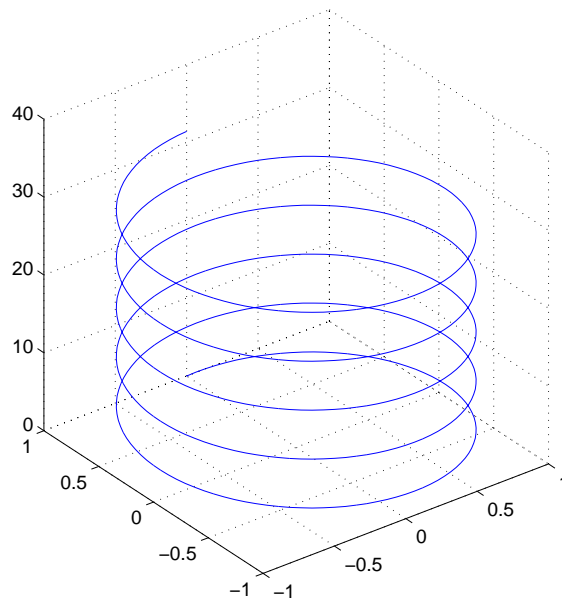

Plotting Matrix Data

If the arguments to `plot3` are matrices of the same size, `MATLAB` plots lines obtained from the columns of `X`, `Y`, and `Z`. For example,

```
[X,Y] = meshgrid([-2:0.1:2]);
```

```
Z = X.*exp(-X.^2-Y.^2);  
plot3(X,Y,Z)  
grid on
```

Notice how MATLAB cycles through line colors.

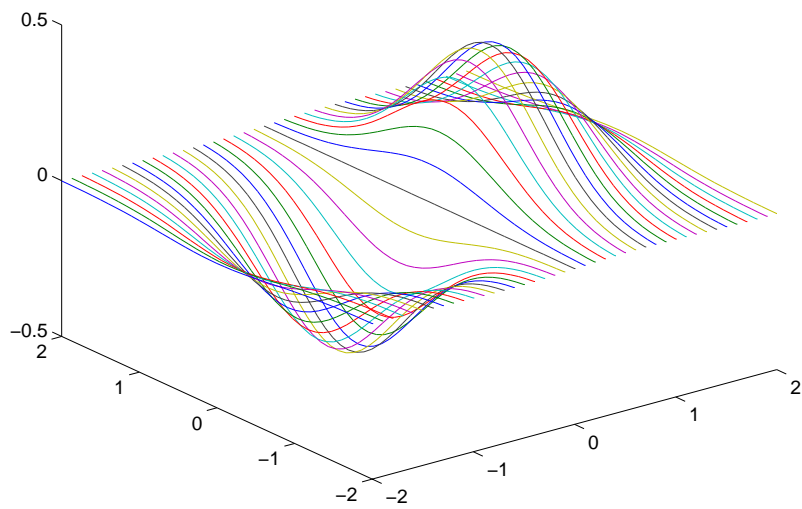

Representing a Matrix as a Surface

MATLAB defines a surface by the z -coordinates of points above a rectangular grid in the x - y plane. The plot is formed by joining adjacent points with straight lines. Surface plots are useful for visualizing matrices that are too large to display in numerical form and for graphing functions of two variables.

MATLAB can create different forms of surface plots. Mesh plots are wire-frame surfaces that color only the lines connecting the defining points. Surface plots display both the connecting lines and the faces of the surface in color. This table lists the various forms.

Function	Used to Create
<code>mesh</code> , <code>surf</code>	Surface plot
<code>meshc</code> , <code>surfc</code>	Surface plot with contour plot beneath it
<code>meshz</code>	Surface plot with curtain plot (reference plane)
<code>pcolor</code>	Flat surface plot (value is proportional only to color)
<code>surf1</code>	Surface plot illuminated from specified direction
<code>surface</code>	Low-level function (on which high-level functions are based) for creating surface graphics objects

Mesh and Surface Plots

The `mesh` and `surf` commands create 3-D surface plots of matrix data. If Z is a matrix for which the elements $Z(i, j)$ define the height of a surface over an underlying (i, j) grid, then

```
mesh(Z)
```

generates a colored, wire-frame view of the surface and displays it in a 3-D view. Similarly,

```
surf(Z)
```

generates a colored, faceted view of the surface and displays it in a 3-D view. Ordinarily, the facets are quadrilaterals, each of which is a constant color,

outlined with black mesh lines, but the shading command allows you to eliminate the mesh lines (`shading flat`) or to select interpolated shading across the facet (`shading interp`).

Surface object properties provide additional control over the visual appearance of the surface. You can specify edge line styles, vertex markers, face coloring, lighting characteristics, and so on.

Visualizing Functions of Two Variables

The first step in displaying a function of two variables, $z = f(x,y)$, is to generate X and Y matrices consisting of repeated rows and columns, respectively, over the domain of the function. Then use these matrices to evaluate and graph the function.

The `meshgrid` function transforms the domain specified by two vectors, x and y , into matrices X and Y . You then use these matrices to evaluate functions of two variables. The rows of X are copies of the vector x and the columns of Y are copies of the vector y .

To illustrate the use of `meshgrid`, consider the $\sin(r)/r$ or `sinc` function. To evaluate this function between -8 and 8 in both x and y , you need pass only one vector argument to `meshgrid`, which is then used in both directions.

```
[X,Y] = meshgrid(-8:.5:8);  
R = sqrt(X.^2 + Y.^2) + eps;
```

The matrix R contains the distance from the center of the matrix, which is the origin. Adding `eps` prevents the divide by zero (in the next step) that produces `Inf` values in the data.

Forming the `sinc` function and plotting Z with `mesh` results in the 3-D surface.

```
Z = sin(R)./R;  
mesh(X,Y,Z)
```

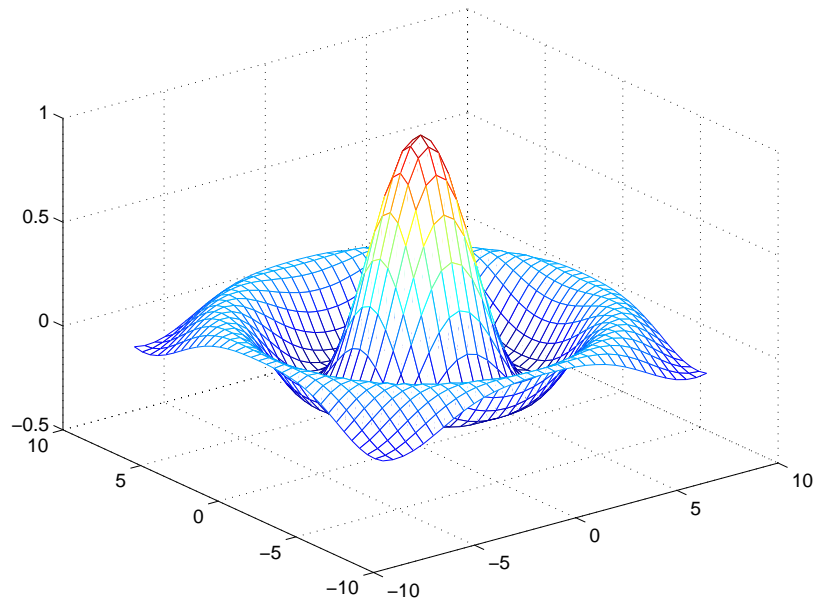

Emphasizing Surface Shape

MATLAB provides a number of techniques that can enhance the information content of your graphs. For example, this graph of the sinc function uses the same data as the previous graph, but employs lighting and view adjustment to emphasize the shape of the graphed function (`daspect`, `axis`, `view`, `camlight`).

```
surf(X,Y,Z,'FaceColor','interp',...
      'EdgeColor','none',...
      'FaceLighting','phong')
daspect([5 5 1])
axis tight
view(-50,30)
camlight left
```

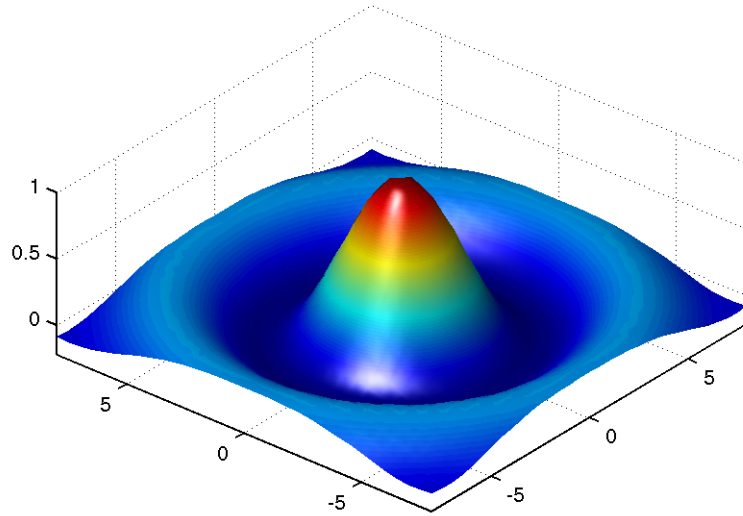

See the `surf` function for more information on surface plots.

Surface Plots of Nonuniformly Sampled Data

You can use `meshgrid` to create a grid of uniformly sampled data points at which to evaluate and graph the `sinc` function. MATLAB then constructs the surface plot by connecting neighboring matrix elements to form a mesh of quadrilaterals.

To produce a surface plot from nonuniformly sampled data, first use `griddata` to interpolate the values at uniformly spaced points, and then use `mesh` and `surf` in the usual way.

Example — Displaying Nonuniform Data on a Surface

This example evaluates the `sinc` function at random points within a specific range and then generates uniformly sampled data for display as a surface plot. The process involves these tasks:

- Use `linspace` to generate evenly spaced values over the range of your unevenly sampled data.

- Use `meshgrid` to generate the plotting grid with the output of `linspace`.
- Use `griddata` to interpolate the irregularly sampled data to the regularly spaced grid returned by `meshgrid`.
- Use a plotting function to display the data.

- 1 First, generate unevenly sampled data within the range $[-8, 8]$ and use it to evaluate the function.

```
x = rand(100,1)*16 - 8;  
y = rand(100,1)*16 - 8;  
r = sqrt(x.^2 + y.^2) + eps;  
z = sin(r)./r;
```

- 2 The `linspace` function provides a convenient way to create uniformly spaced data with the desired number of elements. The following statements produce vectors over the range of the random data with the same resolution as that generated by the `-8:.5:8` statement in the previous sinc example.

```
xlin = linspace(min(x),max(x),33);  
ylin = linspace(min(y),max(y),33);
```

- 3 Now use these points to generate a uniformly spaced grid.

```
[X,Y] = meshgrid(xlin,ylin);
```

- 4 The key to this process is to use `griddata` to interpolate the values of the function at the uniformly spaced points, based on the values of the function at the original data points (which are random in this example). This statement uses a triangle-based cubic interpolation to generate the new data.

```
Z = griddata(x,y,z,X,Y,'cubic');
```

- 5 Plotting the interpolated and the nonuniform data produces

```
mesh(X,Y,Z) %interpolated  
axis tight; hold on  
plot3(x,y,z, '.', 'MarkerSize',15) %nonuniform
```

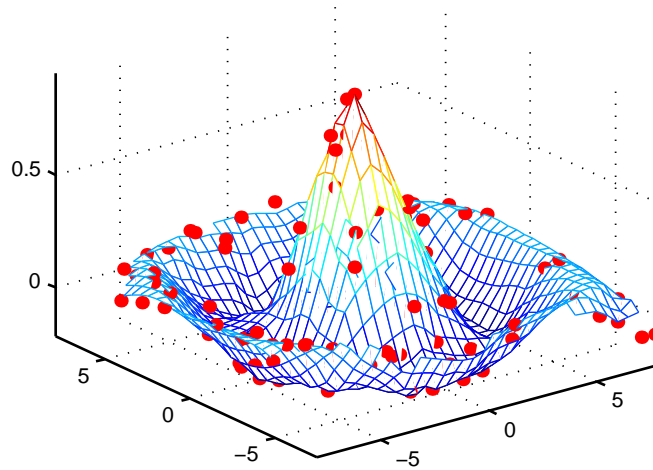

Parametric Surfaces

The functions that draw surfaces can take two additional vector or matrix arguments to describe surfaces with specific x and y data. If Z is an m -by- n matrix, x is an n -vector, and y is an m -vector, then

$$\text{mesh}(x, y, Z, C)$$

describes a mesh surface with vertices having color $C(i, j)$ and located at the points

$$(x(j), y(i), Z(i, j))$$

where x corresponds to the columns of Z and y to its rows.

More generally, if X , Y , Z , and C are matrices of the same dimensions, then

$$\text{mesh}(X, Y, Z, C)$$

describes a mesh surface with vertices having color $C(i, j)$ and located at the points

$$(X(i, j), Y(i, j), Z(i, j))$$

This example uses spherical coordinates to draw a sphere and color it with the pattern of pluses and minuses in a Hadamard matrix, an orthogonal matrix used in signal processing coding theory. The vectors θ and ϕ are in the range $-\pi \leq \theta \leq \pi$ and $-\pi/2 \leq \phi \leq \pi/2$. Because θ is a row vector and ϕ is a column vector, the multiplications that produce the matrices X , Y , and Z are vector outer products.

```
k = 5;  
n = 2^k - 1;  
theta = pi*( n:2:n)/n;  
phi = (pi/2)*( n:2:n)'/n;  
X = cos(phi)*cos(theta);  
Y = cos(phi)*sin(theta);  
Z = sin(phi)*ones(size(theta));  
colormap([0 0 0;1 1 1])  
C = hadamard(2^k);  
surf(X,Y,Z,C)  
axis square
```

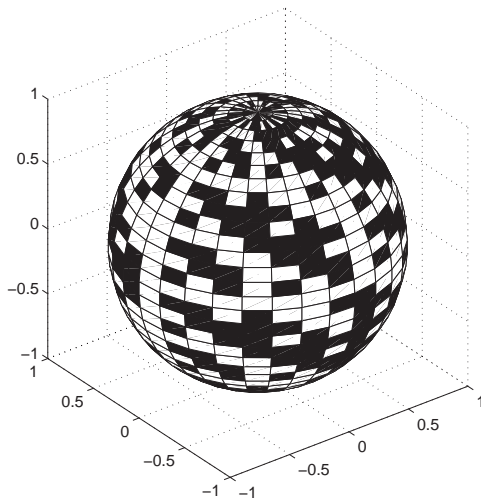

Hidden Line Removal

By default, MATLAB removes lines that are hidden from view in mesh plots, even though the faces of the plot are not colored. You can disable hidden line removal and allow the faces of a mesh plot to be transparent with the command

```
hidden off
```

This is the surface plot with hidden set to off.

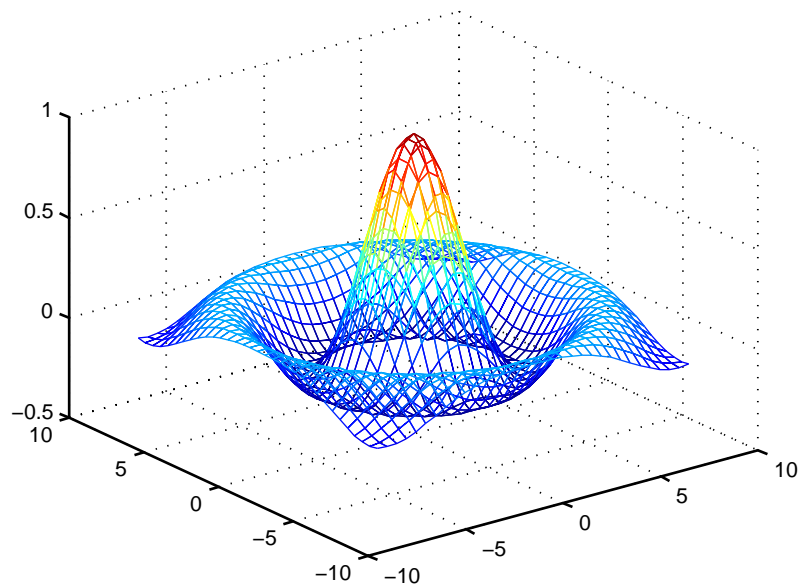

Coloring Mesh and Surface Plots

You can enhance the information content of surface plots by controlling the way MATLAB applies color to these plots. MATLAB can map particular data values to colors specified explicitly or can map the entire range of data to a predefined range of colors called a *colormap*.

Coloring Techniques

There are three coloring techniques:

- Indexed Color — MATLAB colors the surface plot by assigning each data point an index into the figure's colormap. The way MATLAB applies these colors depends on the type of shading used (faceted, flat, or interpolated).
- Truecolor — MATLAB colors the surface plot using the explicitly specified colors (i.e., the RGB triplets). The way MATLAB applies these colors depends on the type of shading used (faceted, flat, or interpolated). To be rendered accurately, truecolor requires computers with 24-bit displays; however, MATLAB simulates truecolor on indexed systems. See the shading command for information on the types of shading.
- Texture Mapping — Texture mapping displays a 2-D image mapped onto a 3-D surface.

Types of Color Data

The type of color data you specify (i.e., single values or RGB triplets) determines how MATLAB interprets it. When you create a surface plot, you can

- Provide no explicit color data, in which case MATLAB generates colormap indices from the z -data.
- Specify an array of color data that is equal in size to the z -data and is used for indexed colors.
- Specify an m -by- n -by-3 array of color data that defines an RGB triplet for each element in the m -by- n z -data array and is used for truecolor.

Colormaps

Each MATLAB figure window has a colormap associated with it. A colormap is simply a three-column matrix whose length is equal to the number of colors it defines. Each row of the matrix defines a particular color by specifying three values in the range 0 to 1. These values define the RGB components (i.e., the intensities of the red, green, and blue video components).

The colormap function, with no arguments, returns the current figure's colormap.

For example, the MATLAB default colormap contains 64 colors and the 57th color is red.

```
cm = colormap;
cm(57,:)
ans =
    1    0    0
```

RGB Color Components

This table lists some representative RGB color definitions.

Red	Green	Blue	Color
0	0	0	Black
1	1	1	White
1	0	0	Red
0	1	0	Green
0	0	1	Blue
1	1	0	Yellow
1	0	1	Magenta
0	1	1	Cyan
0.5	0.5	0.5	Gray
0.5	0	0	Dark red

Red	Green	Blue	Color
1	0.62	0.40	Copper
0.49	1	0.83	Aquamarine

You can create colormaps with MATLAB array operations or you can use any of several functions that generate useful maps, including `hsv`, `hot`, `cool`, `summer`, and `gray`. Each function has an optional parameter that specifies the number of rows in the resulting map.

For example,

```
hot(m)
```

creates an m -by-3 matrix whose rows specify the RGB intensities of a map that varies from black, through shades of red, orange, and yellow, to white.

If you do not specify the colormap length, MATLAB creates a colormap the same length as the current colormap. The default colormap is `jet(64)`.

If you use long colormaps (> 64 colors) in each of several figure windows, it might become necessary for the operating system to swap in different color lookup tables as the active focus is moved among the windows.

Displaying Colormaps

The `colorbar` function displays the current colormap, either vertically or horizontally, in the figure window along with your graph. For example, the statements

```
[x,y] = meshgrid([-2:.2:2]);
Z = x.*exp(-x.^2-y.^2);
surf(x,y,Z,gradient(Z))
colorbar
```

produce a surface plot and a vertical strip of color corresponding to the colormap. Note how the colorbar indicates the mapping of data value to color with the axis labels.

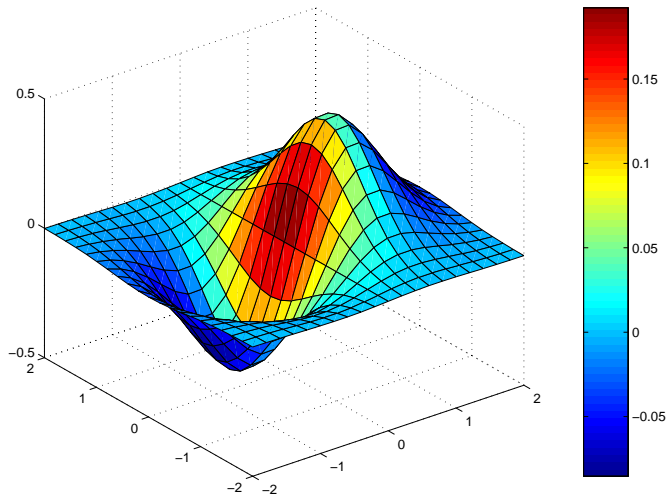

Indexed Color Surfaces – Direct and Scaled Colormapping

MATLAB can use two different methods to map indexed color data to the colormap — direct and scaled.

Direct Mapping

Direct mapping uses the color data directly as indices into the colormap. For example, a value of 1 points to the first color in the colormap, a value of 2 points to the second color, and so on. If the color data is noninteger, MATLAB rounds it toward zero. Values greater than the number of colors in the colormap are set equal to the last color in the colormap (i.e., the number `length(colormap)`). Values less than 1 are set to 1.

Scaled Mapping

Scaled mapping uses a two-element vector `[cmin cmax]` (specified with the `caxis` command) to control the mapping of color data to the figure colormap. `cmin` specifies the data value to map to the first color in the colormap and `cmax` specifies the data value to map to the last color in the colormap. Data values in

between are linearly transformed from the second to the next-to-last color, using the expression

```
colormap_index = fix((color_data-cmin)/(cmax-cmin)*cm_length)+1
```

`cm_length` is the length of the colormap.

By default, MATLAB sets `cmin` and `cmax` to span the range of the color data of all graphics objects within the axes. However, you can set these limits to any range of values. This enables you to display multiple axes within a single figure window and use different portions of the figure's colormap for each one. See “Calculating Color Limits” in Axes Properties of the Using MATLAB Graphics documentation for an example that uses color limits.

By default, MATLAB uses scaled mapping. To use direct mapping, you must turn off scaling when you create the plot. For example,

```
surf(Z,C,'CDataMapping','direct')
```

See `surface` for more information on specifying color data.

Specifying Indexed Colors

When creating a surface plot with a single matrix argument, `surf(Z)` for example, the argument `Z` specifies both the height and the color of the surface. MATLAB transforms `Z` to obtain indices into the current colormap.

With two matrix arguments, the statement

```
surf(Z,C)
```

independently specifies the color using the second argument.

Example — Mapping Surface Curvature to Color

The Laplacian of a surface plot is related to its curvature; it is positive for functions shaped like $i^2 + j^2$ and negative for functions shaped like $-(i^2 + j^2)$. The function `del2` computes the discrete Laplacian of any matrix. For example, use `del2` to determine the color for the data returned by `peaks`.

```
P = peaks(40);
C = del2(P);
surf(P,C)
colormap hot
```

Creating a color array by applying the Laplacian to the data is useful because it causes regions with similar curvature to be drawn in the same color.

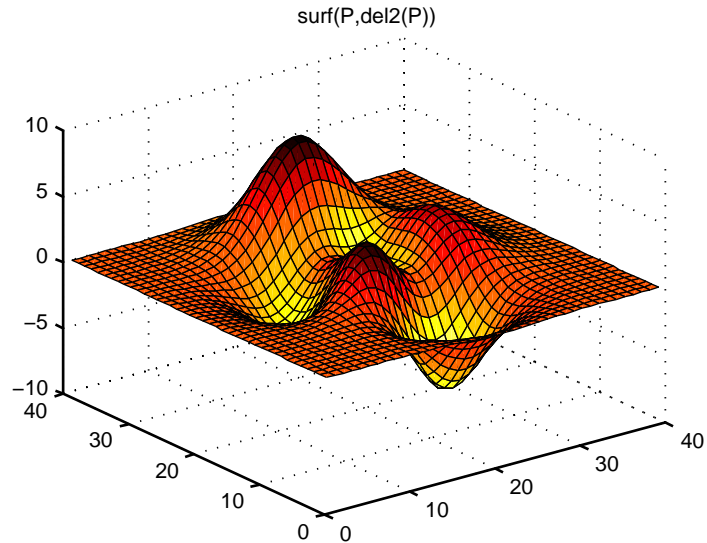

Compare this surface coloring with that produced by the statements

```
surf(P)  
colormap hot
```

which use the same colormap, but map regions with similar z value (height above the x - y plane) to the same color.

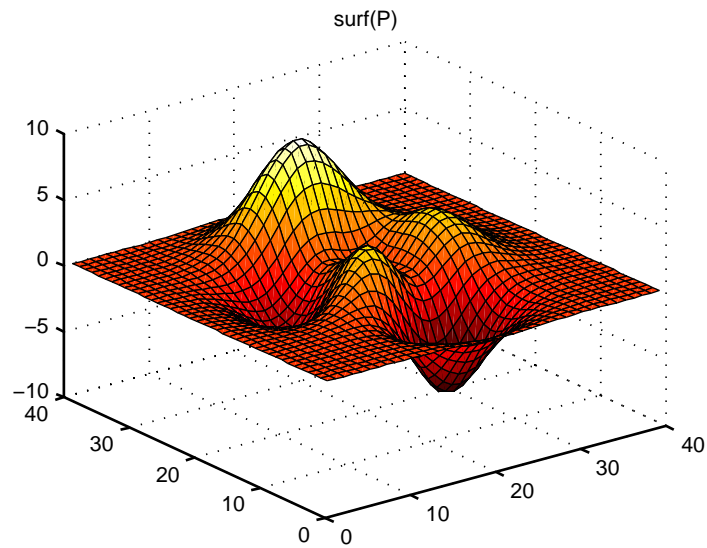

Altering Colormaps

Because colormaps are matrices, you can manipulate them like other arrays. The `brighten` function takes advantage of this fact to increase or decrease the intensity of the colors. Plotting the values of the R, G, and B components of a colormap using `rgbplot` illustrates the effects of `brighten`.

`brighten(copper,-0.5)`

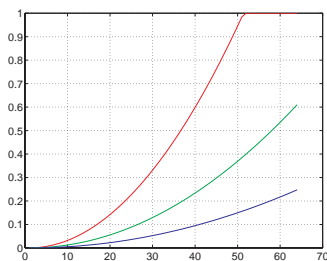

`copper`

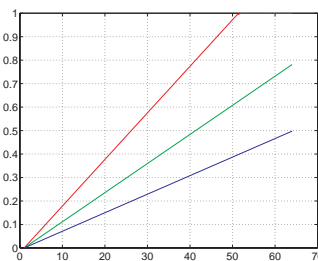

`brighten(copper,0.5)`

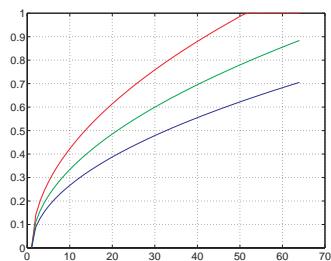

NTSC Color Encoding

The brightness component of television signals uses the NTSC color encoding scheme.

```
b = .30*red + .59*green + .11*blue
    = sum(diag([.30 .59 .11])*map')';
```

Using the nonlinear grayscale map,

```
colormap([b b b])
```

effectively converts a color image to its NTSC black-and-white equivalent.

Truecolor Surfaces

Computer systems with 24-bit displays are capable of displaying over 16 million (2^{24}) colors, as opposed to the 256 colors available on 8-bit displays. You can take advantage of this capability by defining color data directly as RGB values and eliminating the step of mapping numerical values to locations in a colormap.

Specify truecolor using an m -by- n -by-3 array, where the size of Z is m -by- n .

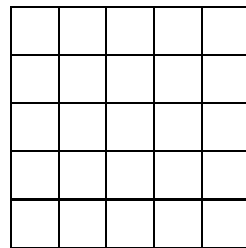

m -by- n matrix defining surface plot

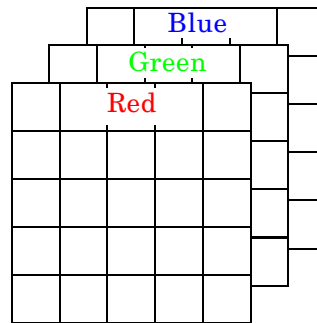

Corresponding m -by- n -by-3 matrix specifying truecolor for the surface plot

For example, the statements

```
Z = peaks(25);
C(:, :, 1) = rand(25);
C(:, :, 2) = rand(25);
```

```
C(:,:,3) = rand(25);  
surf(Z,C)
```

create a plot of the peaks matrix with random coloring.

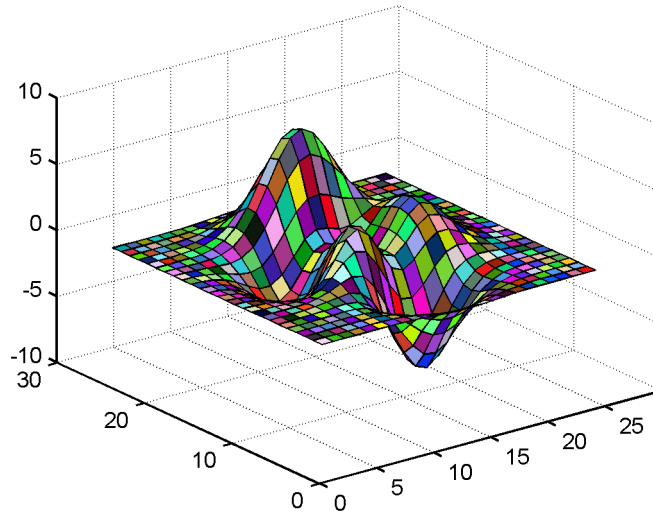

You can set surface properties as with indexed color.

```
surf(Z,C,'FaceColor','interp','FaceLighting','phong')  
camlight right
```

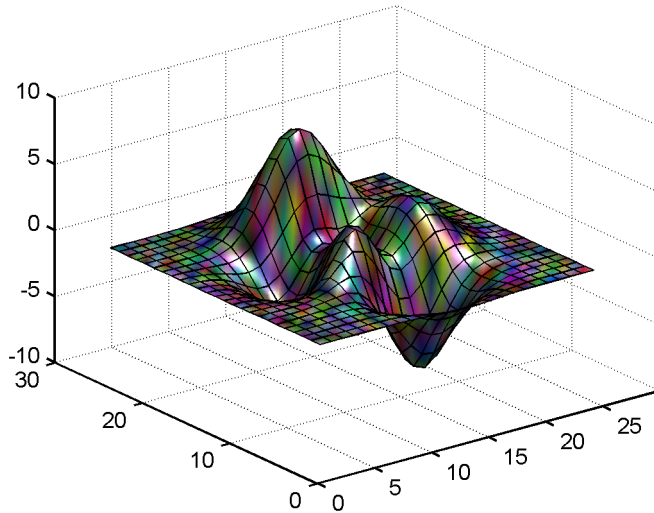

Rendering Methods for Truecolor

MATLAB always uses either OpenGL or the Z-buffer rendering method when displaying truecolor. If the figure `RendererMode` property is set to `auto`, MATLAB automatically switches the value of the `Renderer` property to `zbuffer` whenever you specify truecolor data.

If you explicitly set `Renderer` to `painters` (this sets `RendererMode` to `manual`) and attempt to define an `image`, `patch`, or `surface` object using truecolor, MATLAB returns a warning and does not render the object.

See the `image`, `patch`, and `surface` functions for information on defining truecolor for these objects.

Texture Mapping

Texture mapping is a technique for mapping a 2-D image onto a 3-D surface by transforming color data so that it conforms to the surface plot. It allows you to apply a “texture,” such as bumps or wood grain, to a surface without performing the geometric modeling necessary to create a surface with these features. The color data can also be any image, such as a scanned photograph.

Texture mapping allows the dimensions of the color data array to be different from the data defining the surface plot. You can apply an image of arbitrary size to any surface. MATLAB interpolates texture color data so that it is mapped to the entire surface.

Example — Texture Mapping a Surface

This example creates a spherical surface using the `sphere` function and texture maps it with an image of the earth taken from space. Because the earth image is a view of earth from one side, this example maps the image to only one side of the sphere, padding the image data with 1's. In this case, the image data is a 257-by-250 matrix, so it is padded equally on each side with two 257-by-125 matrices of 1's by concatenating the three matrices.

To use texture mapping, set the `FaceColor` to `texturemap` and assign the image to the surface's `CData`.

```
load earth % Load image data, X, and colormap, map
sphere; h = findobj('Type','surface');
hemisphere = [ones(257,125),...
              X,...
              ones(257,125)];
set(h,'CData',flipud(hemisphere),'FaceColor','texturemap')
colormap(map)
axis equal
view([90 0])
set(gca,'CameraViewAngleMode','manual')
view([65 30])
```

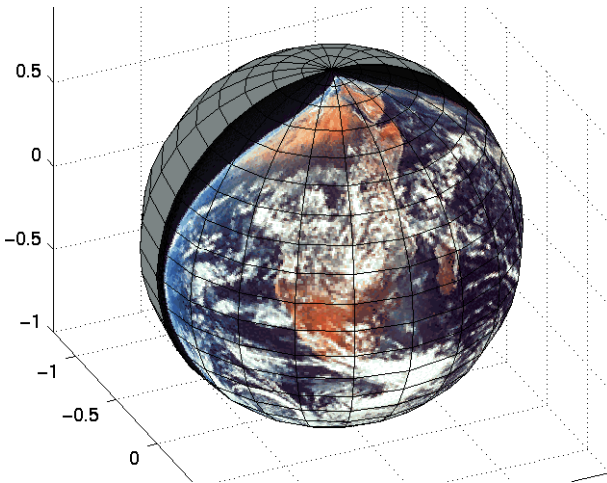
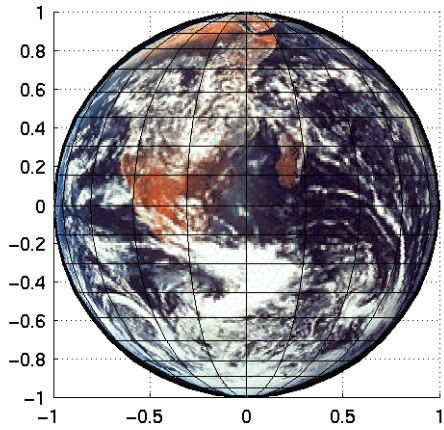

Defining the View

Viewing Overview (p. 12-2)	Overview of topics covered in this chapter
Setting the Viewpoint with Azimuth and Elevation (p. 12-4)	Using the simple azimuth and elevation view model to define the viewpoint, including definition and examples
Defining Scenes with Camera Graphics (p. 12-8)	Using the camera view model to control 3-D scenes (illustration defines terms)
View Control with the Camera Toolbar (p. 12-9)	Camera tools for manipulating 3-D scenes
Camera Graphics Functions (p. 12-19)	Functions that control the camera view model
Example — Dollying the Camera (p. 12-20)	Example showing how to reposition a scene when the user clicks over an image
Example — Moving the Camera Through a Scene (p. 12-22)	Example showing how to move a camera through a scene along a path traced by a stream line and showing how to move a light source with the camera
Low-Level Camera Properties (p. 12-28)	Description of the graphic object properties that control the camera
View Projection Types (p. 12-34)	Orthographic and perspective project types compared and illustrated and the interaction between camera properties and projection type
Understanding Axes Aspect Ratio (p. 12-39)	How MATLAB determines the axes aspect ratio for graphs and how you can specify aspect ratio
Axes Aspect Ratio Properties (p. 12-44)	Axes properties that control the aspect ratio and how to set them to achieve particular results

Viewing Overview

The *view* is the particular orientation you select to display your graph or graphical scene. The term *viewing* refers to the process of displaying a graphical scene from various directions, zooming in or out, changing the perspective and aspect ratio, flying by, and so on.

This section describes how to define the various viewing parameters to obtain the view you want. Generally, viewing is applied to 3-D graphs or models, although you might want to adjust the aspect ratio of 2-D views to achieve specific proportions or make a graph fit in a particular shape.

MATLAB viewing is composed of two basic areas:

- Positioning the viewpoint to orient the scene
- Setting the aspect ratio and relative axis scaling to control the shape of the objects being displayed

Positioning the Viewpoint

- Setting the Viewpoint — Discusses how to specify the point from which you view a graph in terms of azimuth and elevation. This is conceptually simple, but does have limitations.
- Defining Scenes with Camera Graphics, View Control with the Camera Toolbar, and Camera Graphics Functions — How to compose complex scenes using the MATLAB camera viewing model.
- Dollying the Camera and Moving the Camera Through a Scene — Programming techniques for moving the view around and through scenes.
- Low-Level Camera Properties — The graphics properties that control the camera and illustrates the effects they cause.

Setting the Aspect Ratio

- View Projection Types — Describes orthographic and perspective projection types and illustrates their use.
- Understanding Axes Aspect Ratio and Axes Aspect Ratio Properties — How MATLAB sets the aspect ratio of the axes and how you can select the most appropriate setting for your graphs.

Default Views

MATLAB automatically sets the view when you create a graph. The actual view that MATLAB selects depends on whether you are creating a 2- or 3-D graph. See “Default Viewpoint Selection” on page 12-29 and “Default Aspect Ratio Selection” on page 12-45 for a description of how MATLAB defines the standard view.

Setting the Viewpoint with Azimuth and Elevation

MATLAB enables you to control the orientation of the graphics displayed in an axes. You can specify the viewpoint, view target, orientation, and extent of the view displayed in a figure window. These viewing characteristics are controlled by a set of graphics properties. You can specify values for these properties directly or you can use the view command and rely on MATLAB automatic property selection to define a reasonable view.

Azimuth and Elevation

The view command specifies the viewpoint by defining azimuth and elevation with respect to the axis origin. Azimuth is a polar angle in the x - y plane, with positive angles indicating counterclockwise rotation of the viewpoint. Elevation is the angle above (positive angle) or below (negative angle) the x - y plane.

This diagram illustrates the coordinate system. The arrows indicate positive directions.

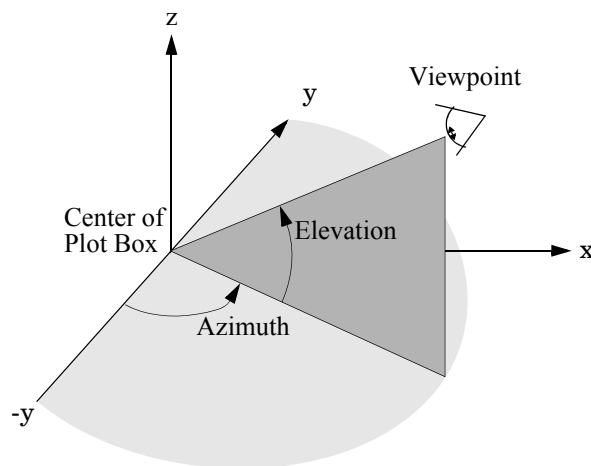

Default 2-D and 3-D Views

MATLAB automatically selects a viewpoint that is determined by whether the plot is 2-D or 3-D:

- For 2-D plots, the default is azimuth = 0° and elevation = 90° .
- For 3-D plots, the default is azimuth = -37.5° and elevation = 30° .

Examples of Views Specified with Azimuth and Elevation

For example, these statements create a 3-D surface plot and display it in the default 3-D view.

```
[X,Y] = meshgrid([-2:.25:2]);  
Z = X.*exp(-X.^2 -Y.^2);  
surf(X,Y,Z)
```

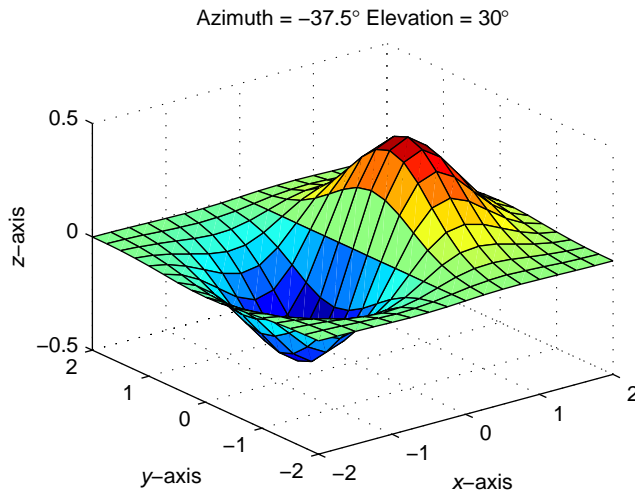

The statement

```
view([180 0])
```

sets the viewpoint so you are looking in the negative y -direction with your eye at the $z = 0$ elevation.

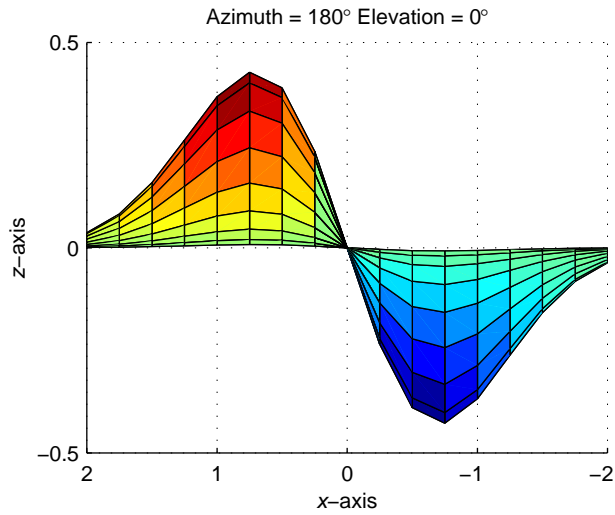

You can move the viewpoint to a location below the axis origin using a negative elevation.

```
view([-37.5 -30])
```

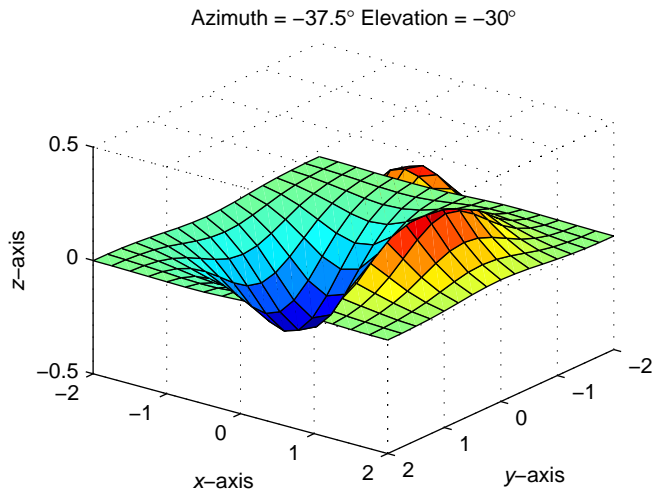

Limitations of Azimuth and Elevation

Specifying the viewpoint in terms of azimuth and elevation is conceptually simple, but it has limitations. It does not allow you to specify the actual position of the viewpoint, just its direction, and the z -axis is always pointing up. It does not allow you to zoom in and out on the scene or perform arbitrary rotations and translations.

MATLAB camera graphics provides greater control than the simple adjustments allowed with azimuth and elevation. The following sections discuss how to use camera properties to control the view.

Defining Scenes with Camera Graphics

When you look at the graphics objects displayed in an axes, you are viewing a scene from a particular location in space that has a particular orientation with regard to the scene. MATLAB provides functionality, analogous to that of a camera with a zoom lens, that enables you to control the view of the scene created by MATLAB.

This picture illustrates how the camera is defined in terms of properties of the axes.

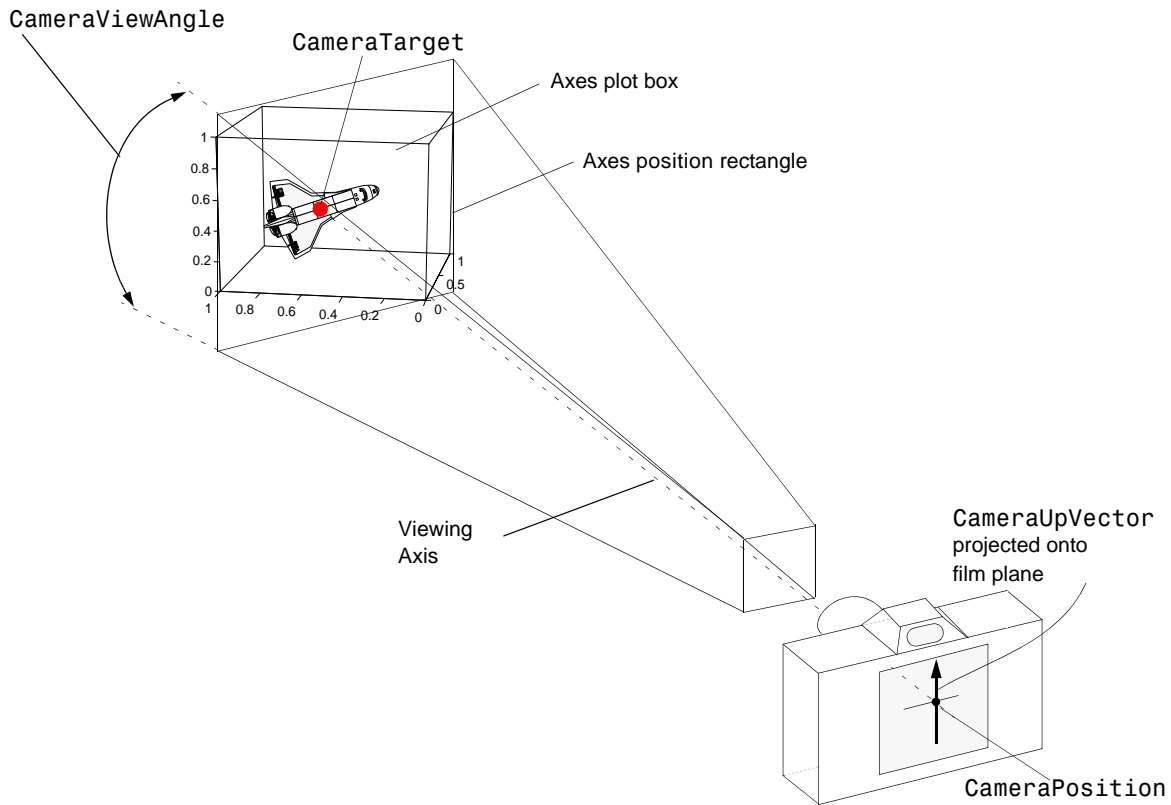

View Control with the Camera Toolbar

The Camera Toolbar enables you to perform a number of viewing operations interactively. To use the Camera Toolbar,

- Display the toolbar by selecting **Camera Toolbar** from the figure window's **View** menu.
- Select the type of camera motion control you want to use.
- Position the cursor over the figure window and click, hold down the right mouse button, then move the cursor in the desired direction.

MATLAB updates the display immediately as you move the mouse.

Camera Toolbar

The toolbar contains the following parts:

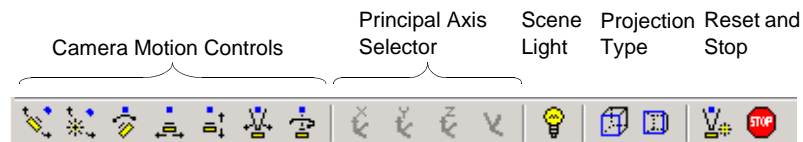

- **Camera Motion Controls** — These tools select which camera motion function to enable. You can also access the camera motion controls from the **Tools** menu.
- **Principal Axis Selector** — Some camera controls operate with respect to a particular axis. These selectors enable you to select the principal axis or to select nonaxis constrained motion. The selectors are grayed out when not applicable to the currently selected function. You can also access the principal axis selector from the **Tools** menu.
- **Scene Light** — The scene light button toggles a light source on or off in the scene (one light per axes).
- **Projection Type** — You can select orthographic or perspective projection types.
- **Reset and Stop** — Reset returns the scene to the standard 3-D view. Stop causes the camera to stop moving (this can be useful if you apply too much cursor movement). You can also access an expanded set of reset functions from the **Tools** menu.

Principal Axes

The principal axis of a scene defines the direction that is oriented upward on the screen. For example, a MATLAB surface plot aligns the up direction along the positive z -axis.

Principal axes constrain camera-tool motion along axes that are (on the screen) parallel and perpendicular to the principal axis that you select. Specifying a principal axis is useful if your data is defined with respect to a specific axis. Z is the default principal axis, because this matches the MATLAB default 3-D view.

Three of the camera tools (Orbit, Pan/Tilt, and Walk) allow you to select a principal axis as well as axis-free motion. On the screen, the axes of rotation are determined by a vertical and a horizontal line, both of which pass through the point defined by the `CameraTarget` property and are parallel and perpendicular to the principal axis.

For example, when the principal axis is z , movement occurs about

- A vertical line that passes through the camera target and is parallel to the z -axis
- A horizontal line that passes through the camera target and is perpendicular to the z -axis

This means the scene (or camera, as the case may be) moves in an arc whose center is at the camera target. The following picture illustrates the rotation axes for a z principal axis.

Horizontal cursor motion results in rotation about the (blue) vertical axis.

Vertical cursor motion causes rotation about the (red) horizontal axis.

Cursor Motion

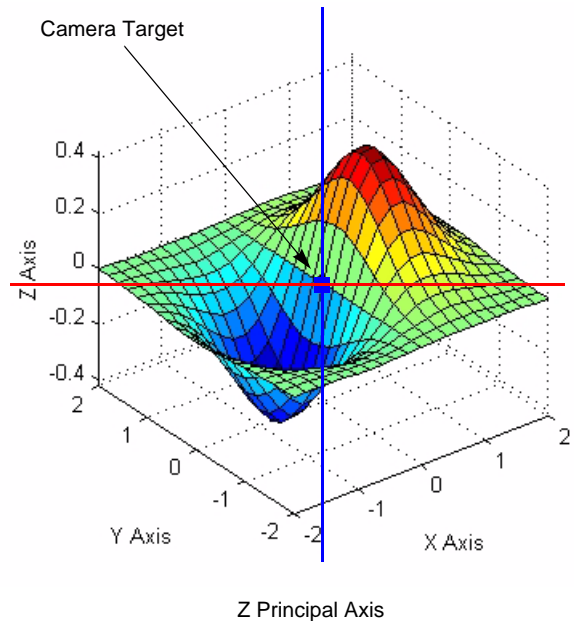

The axes of rotation always pass through the camera target.

Optimizing for 3-D Camera Motion

When you create a plot, MATLAB displays it with an aspect ratio that fits the figure window. This behavior might not create an optimum situation for the manipulation of 3-D graphics, as it can lead to distortion as you move the camera around the scene. To avoid possible distortion, it is best to switch to a 3-D visualization mode (enabled from the command line with the command axis vis3d). When using the camera toolbar, MATLAB automatically switches to the 3-D visualization mode, but warns you first with the following dialog box.

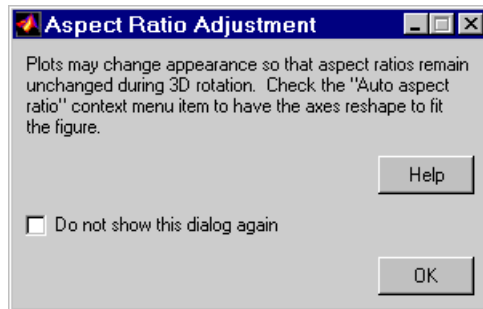

This dialog box appears only once per MATLAB session.

For more information about the underlying effects of related camera properties, see “Understanding Axes Aspect Ratio” on page 12-39. The next section, “Camera Motion Controls,” discusses how to use each tool.

Camera Motion Controls

This section discusses the individual camera motion functions selectable from the toolbar.

Note When interpreting the following diagrams, keep in mind that the camera always points towards the camera target. See “Defining Scenes with Camera Graphics” on page 12-8 for an illustration of the graphics properties involved in camera motion.

Orbit Camera

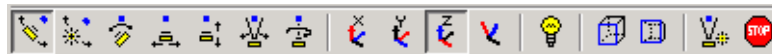

Orbit Camera rotates the camera about the z -axis (by default). You can select x -, y -, z -, or free-axis rotation using the Principal Axis Selectors. When using no principal axis, you can rotate about an arbitrary axis.

Graphics Properties. Orbit Camera changes the `CameraPosition` property while keeping the `CameraTarget` fixed.

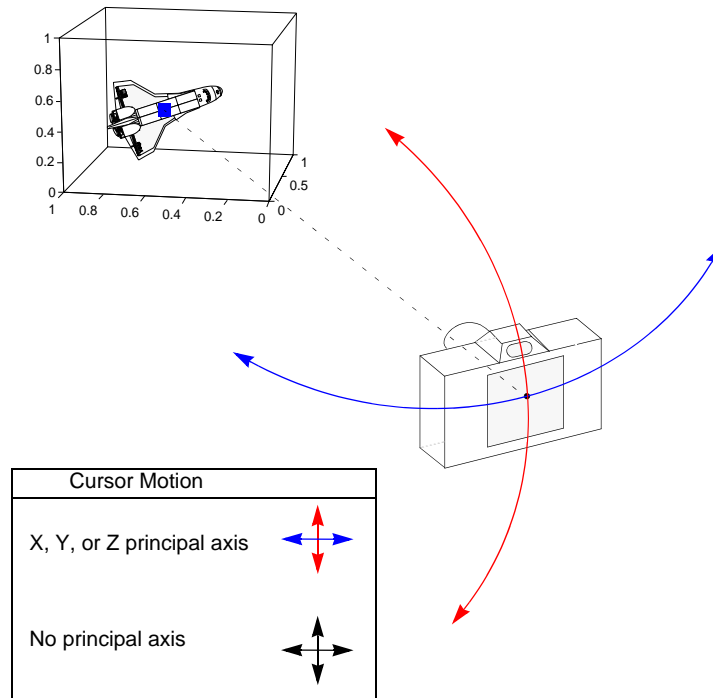

Orbit Scene Light



The scene light is a light source that is placed with respect to the camera position. By default, the scene light is positioned to the right of the camera (i.e., `camLight right`). Orbit Scene Light changes the light's offset from the camera position. There is only one scene light; however, you can add other lights using the `light` command.

Toggle the scene light on and off by clicking the yellow light bulb icon.

Graphics Properties

Orbit Scene Light moves the scene light by changing the light's Position property.

Pan/Tilt Camera



Pan/Tilt Camera moves the point in the scene that the camera points to while keeping the camera fixed. The movement occurs in an arc about the z -axis by default. You can select x -, y -, z -, or free-axis rotation using the Principal Axes Selectors.

Graphics Properties. Pan/Tilt Camera moves the point in the scene that the camera is pointing to by changing the CameraTarget property.

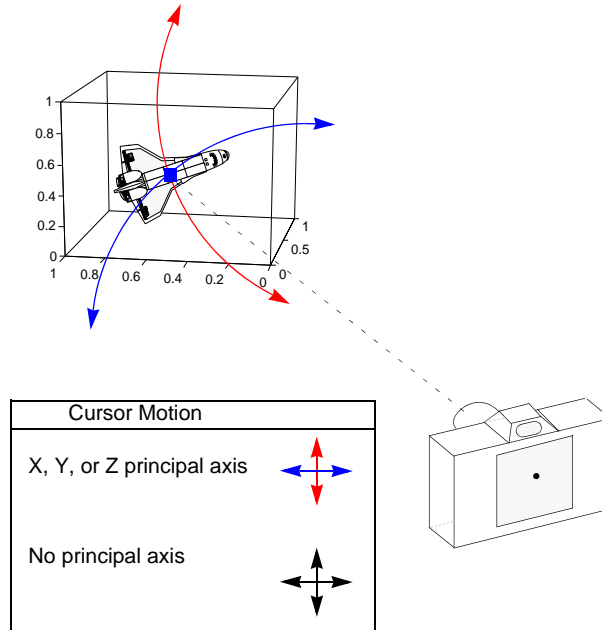

Move Camera Horizontally/Vertically



Moving the cursor horizontally or vertically (or any combination of the two) moves the scene in the same direction.

Graphics Properties. The horizontal and vertical movement is achieved by moving the `CameraPosition` and the `CameraTarget` in unison along parallel lines.

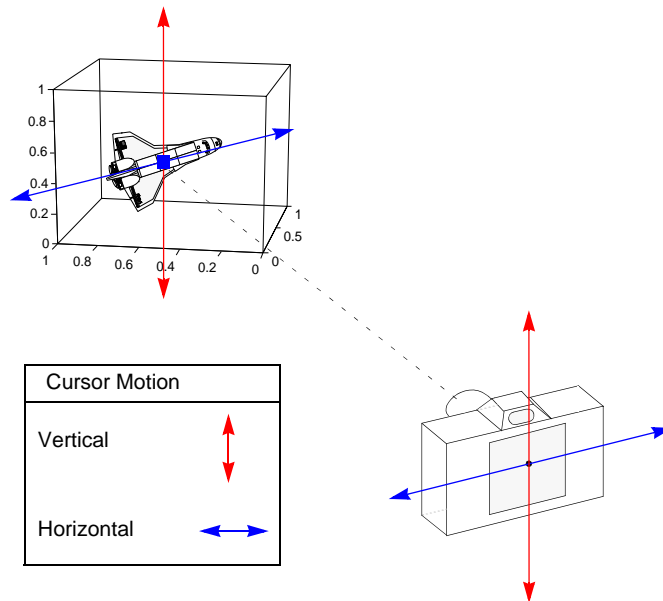

Move Camera Forward and Backward



Moving the cursor up or to the right moves the camera toward the scene.
Moving the cursor down or to the left moves the camera away from the scene.

It is possible to move the camera through objects in the scene and to the other side of the camera target.

Graphics Properties. This function moves the CameraPosition along the line connecting the camera position and the camera target.

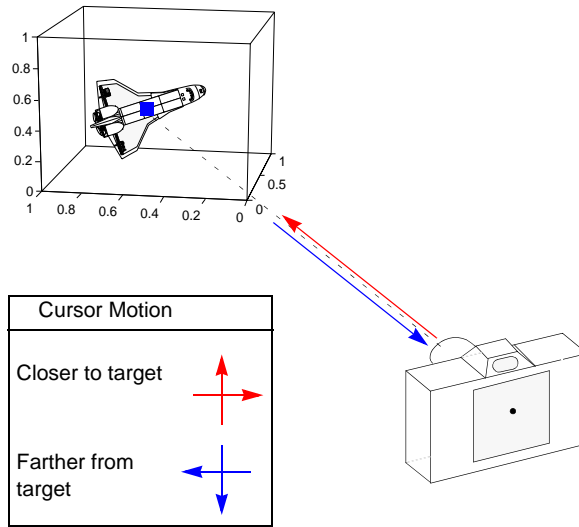

Zoom Camera



Zoom Camera makes the scene larger as you move the cursor up or to the right and smaller as you move the cursor down or to the left. Zooming does not move the camera and therefore cannot move the viewpoint through objects in the scene.

Graphics Properties. Zoom is implemented by changing the `CameraViewAngle`. The larger the angle, the smaller the scene appears, and vice versa.

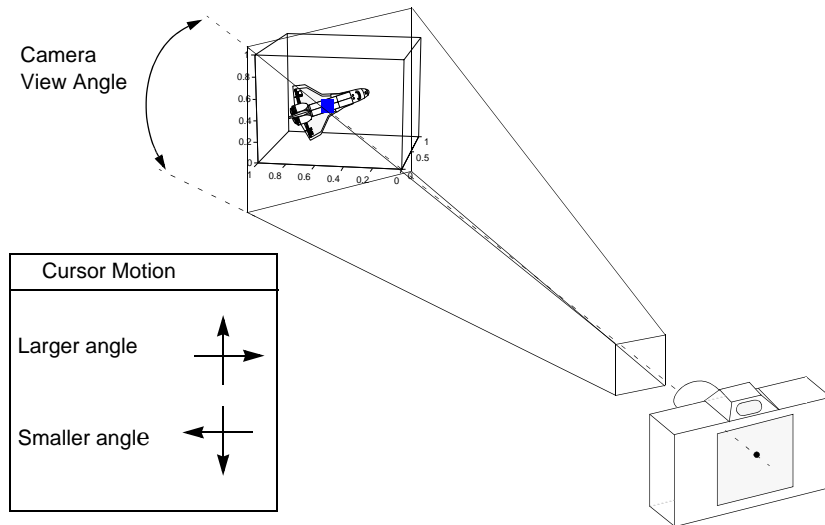

Camera Roll



Camera Roll rotates the camera about the viewing axis, thereby rotating the view on the screen.

Graphics Properties. Camera Roll changes the CameraUpVector.

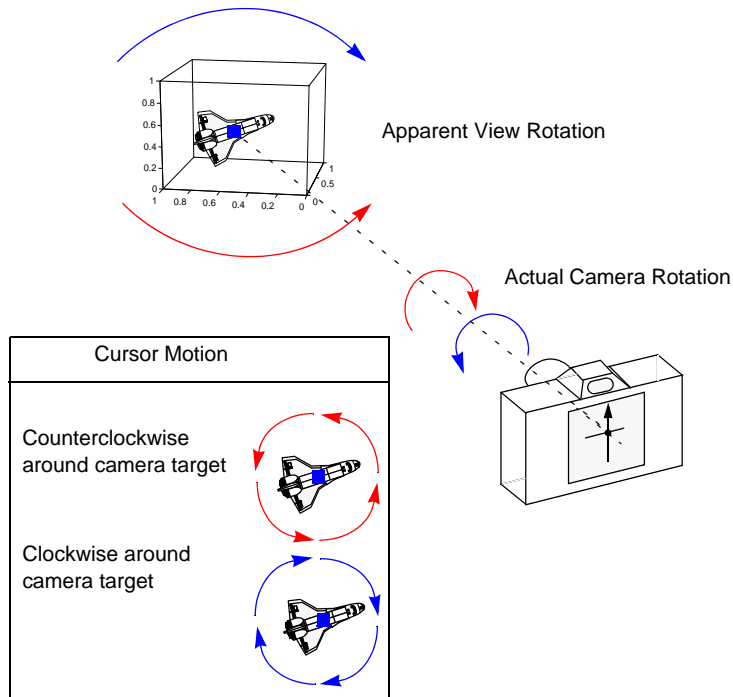

Camera Graphics Functions

The following table lists MATLAB functions that enable you to perform a number of useful camera maneuvers. The individual command descriptions provide information on using each one.

Function	Purpose
camdolly	Move camera position and target
camlookat	View specific objects
camorbit	Orbit the camera about the camera target
campan	Rotate the camera target about the camera position
campos	Set or get the camera position
camproj	Set or get the projection type (orthographic or perspective)
camroll	Rotate the camera about the viewing axis
camtarget	Set or get the camera target location
camup	Set or get the value of the camera up vector
camva	Set or get the value of the camera view angle
camzoom	Zoom the camera in or out on the scene

Example – Dollying the Camera

In the camera metaphor, a dolly is a stage that enables movement of the camera from side to side with respect to the scene. The `camdolly` command implements similar behavior by moving both the position of the camera and the position of the camera target in unison (or just the camera position if you so desire).

This example illustrates how to use `camdolly` to explore different regions of an image.

Summary of Techniques

This example uses

- `ginput` to obtain the coordinates of locations on the image
- The `camdolly data coordinates` option to move the camera and target to the new position based on coordinates obtained from `ginput`
- `camva` to zoom in and to fix the camera view angle, which is otherwise under automatic control

Implementation

First load the Cape Cod image and zoom in by setting the camera view angle (using `camva`).

```
load cape
image(X)
colormap(map)
axis image
camva(camva/2.5)
```

Then use `ginput` to select the x - and y -coordinates of the camera target and camera position.

```
while 1
    [x,y] = ginput(1);
    if ~strcmp(get(gcf, 'SelectionType'), 'normal')
        break
    end
    ct = camtarget;
    dx = x - ct(1);
```

```
dy = y - ct(2);  
camdolly(dx,dy,ct(3),'movetarget','data')  
drawnow  
end
```

Example – Moving the Camera Through a Scene

A fly-through is an effect created by moving the camera through three-dimensional space, giving the impression that you are flying along with the camera as if in an aircraft. You can fly through regions of a scene that might be otherwise obscured by objects in the scene or you can fly by a scene by keeping the camera focused on a particular point.

To accomplish these effects you move the camera along a particular path, the x -axis for example, in a series of steps. To produce a fly-through, move both the camera position and the camera target at the same time.

The following example makes use of the fly-through effect to view the interior of an isosurface drawn within a volume defined by a vector field of wind velocities. This data represents air currents over North America.

See `coneplot` for a fixed visualization of the same data.

Summary of Techniques

This example employs a number of visualization techniques. It uses

- Isosurfaces and cone plots to illustrate the flow through the volume
- Lighting to illuminate the isosurface and cones in the volume
- Stream lines to define a path for the camera through the volume
- Coordinated motion of the camera position, camera target, and light

Graphing the Volume Data

The first step is to draw the isosurface and plot the air flow using cone plots.

See `isosurface`, `isonormals`, `reducepatch`, and `coneplot` for information on using these commands.

Setting the data aspect ratio (`daspect`) to `[1, 1, 1]` before drawing the cone plot enables MATLAB to calculate the size of the cones correctly for the final view.

```
load wind
wind_speed = sqrt(u.^2 + v.^2 + w.^2);

hpatch = patch(isosurface(x,y,z,wind_speed,35));
isonormals(x,y,z,wind_speed,hpatch)
```

```

set(hpatch, FaceColor , red , EdgeColor , none );

[f vt] = reducepatch(isosurface(x,y,z,wind_speed,45),0.05);
daspect([1,1,1]);
hcone = coneplot(x,y,z,u,v,w,vt(:,1),vt(:,2),vt(:,3),2);
set(hcone, 'FaceColor', 'blue', 'EdgeColor', 'none');

```

Setting Up the View

You need to define viewing parameters to ensure the scene is displayed correctly:

- Selecting a perspective projection provides the perception of depth as the camera passes through the interior of the isosurface (`camproj`).
- Setting the camera view angle to a fixed value prevents MATLAB from automatically adjusting the angle to encompass the entire scene as well as zooming in the desired amount (`camva`).

```

camproj perspective
camva(25)

```

Specifying the Light Source

Positioning the light source at the camera location and modifying the reflectance characteristics of the isosurface and cones enhances the realism of the scene:

- Creating a light source at the camera position provides a “headlight” that moves along with the camera through the isosurface interior (`camlight`).
- Setting the reflection properties of the isosurface gives the appearance of a dark interior (`AmbientStrength` set to 0.1) with highly reflective material (`SpecularStrength` and `DiffuseStrength` set to 1).
- Setting the `SpecularStrength` of the cones to 1 makes them highly reflective.

```

hlight = camlight('headlight');
set(hpatch, 'AmbientStrength', .1, ...
    'SpecularStrength', 1, ...
    'DiffuseStrength', 1);
set(hcone, 'SpecularStrength', 1);
set(gcf, 'Color', 'k')

```

Selecting a Renderer

Because this example uses lighting, MATLAB must use either `zbuffer` or, if available, OpenGL renderer settings. The OpenGL renderer is likely to be much faster displaying the animation; however, you need to use gouraud lighting with OpenGL, which is not as smooth as phong lighting, which you can use with the `zbuffer` renderer. The two choices are

```
lighting gouraud
set(gcf, 'Renderer', 'OpenGL')
```

or for `zbuffer`

```
lighting phong
set(gcf, 'Renderer', 'zbuffer')
```

Defining the Camera Path as a Stream Line

Stream lines indicate the direction of flow in the vector field. This example uses the x -, y -, and z -coordinate data of a single stream line to map a path through the volume. The camera is then moved along this path. The tasks include

- Create a stream line starting at the point $x = 80$, $y = 30$, $z = 11$.
- Get the x -, y -, and z -coordinate data of the stream line.
- Delete the stream line (note that you could also use `stream3` to calculate the stream line data without actually drawing the stream line).

```
hsline = streamline(x,y,z,u,v,w,80,30,11);
xd = get(hsline,'XData');
yd = get(hsline,'YData');
zd = get(hsline,'ZData');
delete(hsline)
```

Implementing the Fly-Through

To create a fly-through, move the camera position and camera target along the same path. In this example, the camera target is placed five elements further along the x -axis than the camera. A small value is added to the camera target x position to prevent the position of the camera and target from becoming the same point if the condition $xd(n) = xd(n+5)$ should occur:

- Update the camera position and camera target so that they both move along the coordinates of the stream line.
- Move the light along with the camera.
- Call drawnow to display the results of each move.

```
for i=1:length(xd)-50
    campos([xd(i),yd(i),zd(i)])
    camtarget([xd(i+5)+min(xd)/100,yd(i),zd(i)])
    camlight(hlight,'headlight')
    drawnow
end
```

These snapshots illustrate the view at values of i equal to 10, 110, and 185.

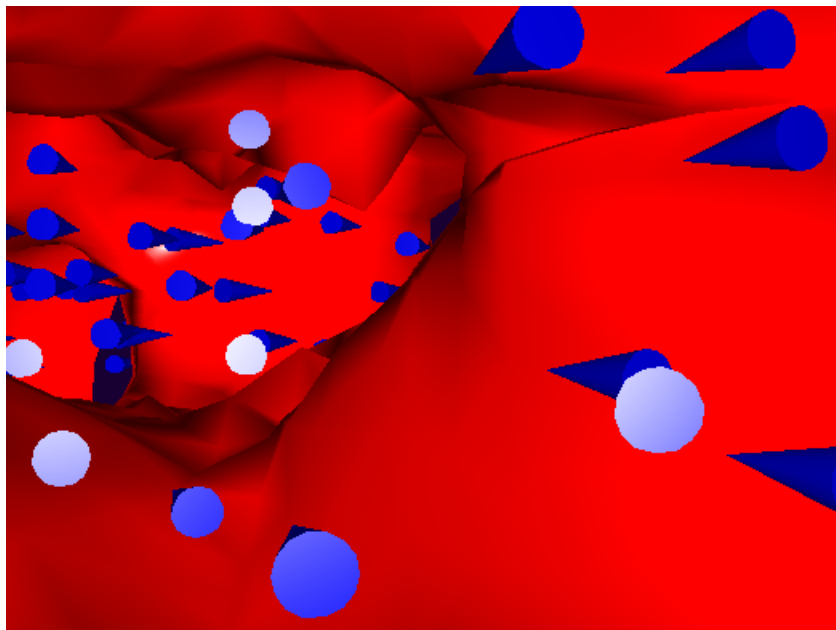

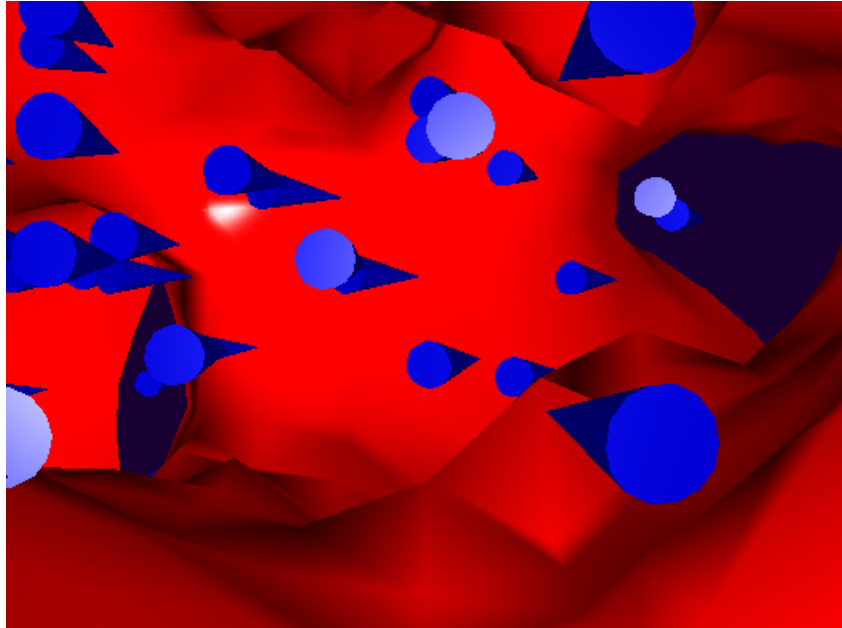

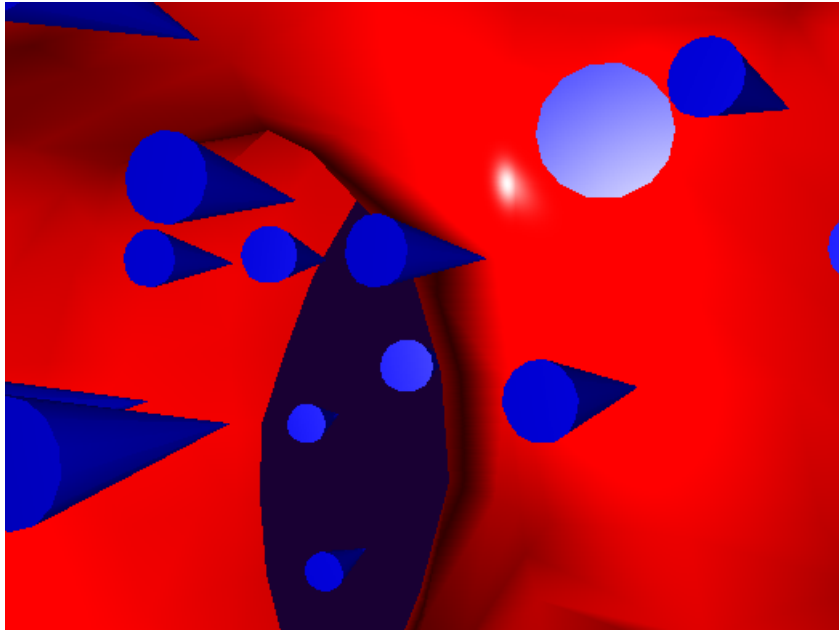

Low-Level Camera Properties

Camera graphics is based on a group of axes properties that control the position and orientation of the camera. In general, the camera commands make it unnecessary to access these properties directly.

Property	Description
CameraPosition	Specifies the location of the viewpoint in axes units.
CameraPositionMode	In automatic mode, MATLAB determines the position based on the scene. In manual mode, you specify the viewpoint location.
CameraTarget	Specifies the location in the axes pointed to by the camera. Together with the CameraPosition, it defines the viewing axis.
CameraTargetMode	In automatic mode, MATLAB specifies the CameraTarget as the center of the axes plot box. In manual mode, you specify the location.
CameraUpVector	The rotation of the camera around the viewing axis is defined by a vector indicating the direction taken as up.
CameraUpVectorMode	In automatic mode, MATLAB orients the up vector along the positive y -axis for 2-D views and along the positive z -axis for 3-D views. In manual mode, you specify the direction.
CameraViewAngle	Specifies the field of view of the “lens.” If you specify a value for CameraViewAngle, MATLAB overrides stretch-to-fill behavior (see “Understanding Axes Aspect Ratio” on page 12-39).
CameraViewAngleMode	In automatic mode, MATLAB adjusts the view angle to the smallest angle that captures the entire scene. In manual mode, you specify the angle. Setting CameraViewAngleMode to manual overrides stretch-to-fill behavior.
Projection	Selects either an orthographic or perspective projection.

Default Viewpoint Selection

When all the camera mode properties are set to auto (the default), MATLAB automatically controls the view, selecting appropriate values based on the assumption that you want the scene to fill the position rectangle (which is defined by the width and height components of the axes `Position` property).

By default, MATLAB

- Sets the `CameraPosition` so the orientation of the scene is the standard MATLAB 2-D or 3-D view (see the `view` command)
- Sets the `CameraTarget` to the center of the plot box
- Sets the `CameraUpVector` so the *y*-direction is up for 2-D views and the *z*-direction is up for 3-D views
- Sets the `CameraViewAngle` to the minimum angle that makes the scene fill the position rectangle (the rectangle defined by the axes `Position` property)
- Uses orthographic projection

This default behavior generally produces desirable results. However, you can change these properties to produce useful effects.

Moving In and Out on the Scene

You can move the camera anywhere in the 3-D space defined by the axes. The camera continues to point towards the target regardless of its position. When the camera moves, MATLAB varies the camera view angle to ensure the scene fills the position rectangle.

Moving Through a Scene

You can create a fly-by effect by moving the camera through the scene. To do this, continually change `CameraPosition` property, moving it toward the target. Because the camera is moving through space, it turns as it moves past the camera target. Override the MATLAB automatic resizing of the scene each time you move the camera by setting the `CameraViewAngleMode` to manual.

If you update the `CameraPosition` and the `CameraTarget`, the effect is to pass through the scene while continually facing the direction of movement.

If the `Projection` is set to perspective, the amount of perspective distortion increases as the camera gets closer to the target and decreases as it gets farther away.

Example — Moving Toward or Away from the Target

To move the camera along the viewing axis, you need to calculate new coordinates for the `CameraPosition` property. This is accomplished by subtracting (to move closer to the target) or adding (to move away from the target) some fraction of the total distance between the camera position and the camera target.

The function `movecamera` calculates a new `CameraPosition` that moves in on the scene if the argument `dist` is positive and moves out if `dist` is negative.

```
function movecamera(dist) %dist in the range [-1 1]
set(gca,'CameraViewAngleMode','manual')
newcp = cpos - dist * (cpos - ctarg);
set(gca,'CameraPosition',newcp)
function out = cpos
out = get(gca,'CameraPosition');
function out = ctarg
out = get(gca,'CameraTarget');
```

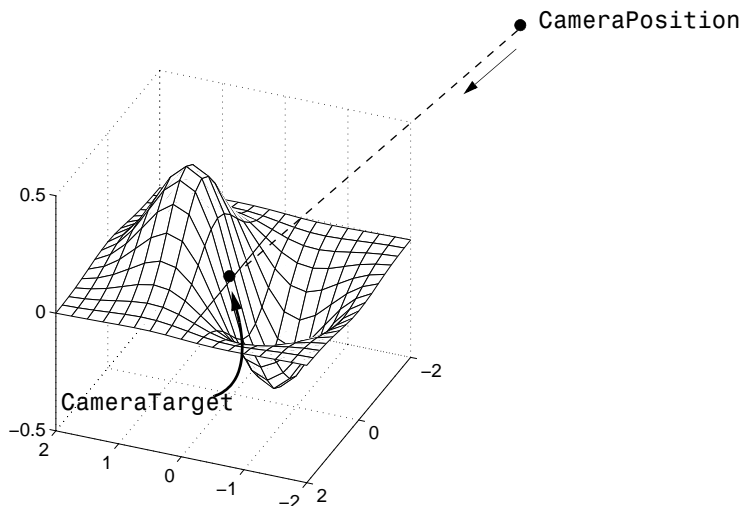

Note that setting the `CameraViewAngleMode` to `manual` overrides MATLAB stretch-to-fill behavior and can cause an abrupt change in the aspect ratio. See

“Understanding Axes Aspect Ratio” on page 12-39 for more information on stretch-to-fill.

Making the Scene Larger or Smaller

Adjusting the `CameraViewAngle` property makes the view of the scene larger or smaller. Larger angles cause the view to encompass a larger area, thereby making the objects in the scene appear smaller. Similarly, smaller angles make the objects appear larger.

Changing `CameraViewAngle` makes the scene larger or smaller without affecting the position of the camera. This is desirable if you want to zoom in without moving the viewpoint past objects that will then no longer be in the scene (as could happen if you changed the camera position). Also, changing the `CameraViewAngle` does not affect the amount of perspective applied to the scene, as changing `CameraPosition` does when the figure `Projection` property is set to perspective.

Revolving Around the Scene

You can use the `view` command to revolve the viewpoint about the z -axis by varying the azimuth, and about the azimuth by varying the elevation. This has the effect of moving the camera around the scene along the surface of a sphere whose radius is the length of the viewing axis. You could create the same effect by changing the `CameraPosition`, but doing so requires you to perform calculations that MATLAB performs for you when you call `view`.

For example, the function `orbit` moves the camera around the scene.

```
function orbit(deg)
[az el] = view;
rotvec = 0:deg/10:deg;
for i = 1:length(rotvec)
    view([az+rotvec(i) el])
    drawnow
end
```

Rotation Without Resizing of Graphics Objects

When `CameraViewAngleMode` is `auto`, MATLAB calculates the `CameraViewAngle` so that the scene is as large as can fit in the axes position rectangle. This causes an apparent size change during rotation of the scene. To

prevent resizing during rotation, you need to set the `CameraViewAngleMode` to `manual` (which happens automatically when you specify a value for the `CameraViewAngle` property). To do this in the `orbit` function, add the statement

```
set(gca, 'CameraViewAngleMode', 'manual')
```

Rotation About the Viewing Axis

You can change the orientation of the scene by specifying the direction defined as *up*. By default, MATLAB defines *up* as the *y*-axis in 2-D views (the `CameraUpVector` is `[0 1 0]`) and the *z*-axis for 3-D views (the `CameraUpVector` is `[0 0 1]`). However, you can specify *up* as any arbitrary direction.

The vector defined by the `CameraUpVector` property forms one axis of the camera's coordinate system. Internally, MATLAB determines the actual orientation of the camera *up* vector by projecting the specified vector onto the plane that is normal to the camera direction (i.e., the viewing axis). This simplifies the specification of the `CameraUpVector` property, because it need not lie in this plane.

In many cases, you might find it convenient to visualize the desired *up* vector in terms of angles with respect to the axes *x*-, *y*-, and *z*-axis. You can then use *direction cosines* to convert from angles to vector components. For a unit vector, the expression simplifies to

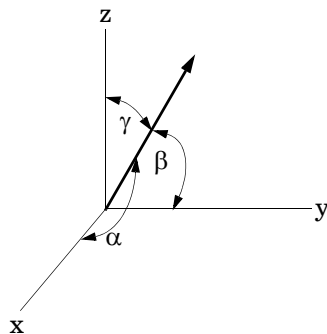

where the angles α , β , and γ are specified in degrees.

```
XComponent = cos( $\alpha \times (\text{pi} \div 180)$ );
```

```
YComponent = cos( $\beta \times (\text{pi} \div 180)$ );  
ZComponent = cos( $\gamma \times (\text{pi} \div 180)$ );
```

(Consult a mathematics book on vector analysis for a more detailed explanation of direction cosines.)

Example — Calculating a Camera Up Vector

To specify an up vector that makes an angle of 30° with the z -axis and lies in the y - z plane, use the expression

```
upvec = [cos( $90 \times (\text{pi}/180)$ ), cos( $60 \times (\text{pi}/180)$ ), cos( $30 \times (\text{pi}/180)$ )];
```

and then set the CameraUpVector property.

```
set(gca, 'CameraUpVector', upvec)
```

Drawing a sphere with this orientation produces

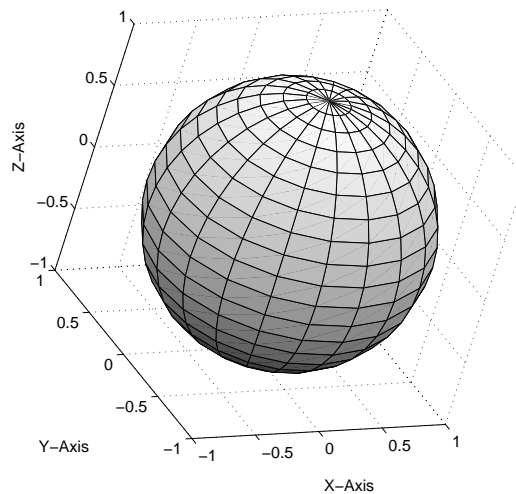

View Projection Types

MATLAB supports both orthographic and perspective projection types for displaying 3-D graphics. The one you select depends on the type of graphics you are displaying:

- orthographic projects the viewing volume as a rectangular parallelepiped (i.e., a box whose opposite sides are parallel). Relative distance from the camera does not affect the size of objects. This projection type is useful when it is important to maintain the actual size of objects and the angles between objects.
- perspective projects the viewing volume as the frustum of a pyramid (a pyramid whose apex has been cut off parallel to the base). Distance causes foreshortening; objects further from the camera appear smaller. This projection type is useful when you want to display realistic views of real objects.

By default, MATLAB displays objects using orthographic projection. You can set the projection type using the `camproj` command.

These pictures show a drawing of a dump truck (created with `patch`) and a surface plot of a mathematical function, both using orthographic projection.

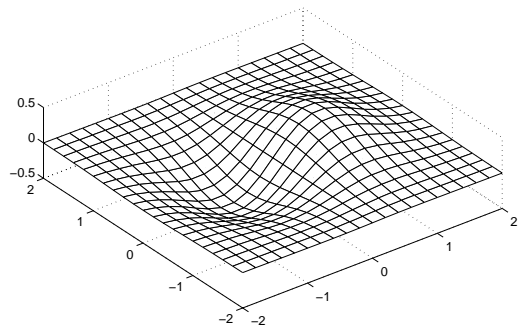
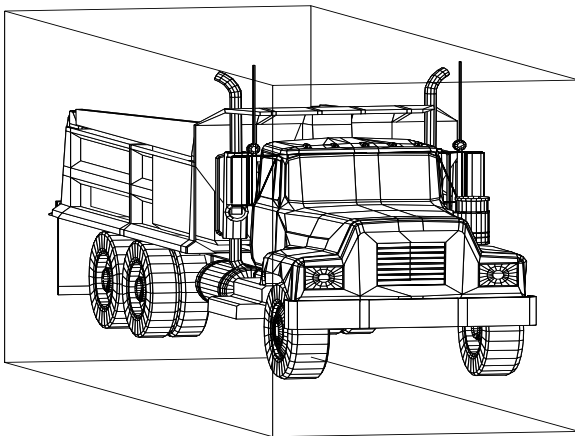

If you measure the width of the front and rear faces of the box enclosing the dump truck, you'll see they are the same size. This picture looks unnatural because it lacks the apparent perspective you see when looking at real objects with depth. On the other hand, the surface plot accurately indicates the values of the function within rectangular space.

Now look at the same graphics objects with perspective added. The dump truck looks more natural because portions of the truck that are farther from the viewer appear smaller. This projection mimics the way human vision works. The surface plot, on the other hand, looks distorted.

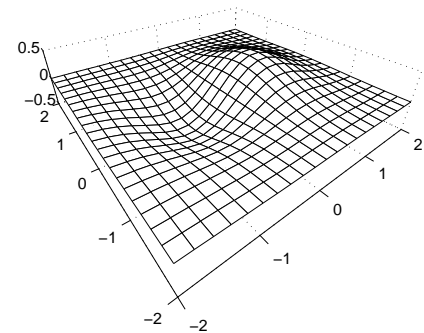
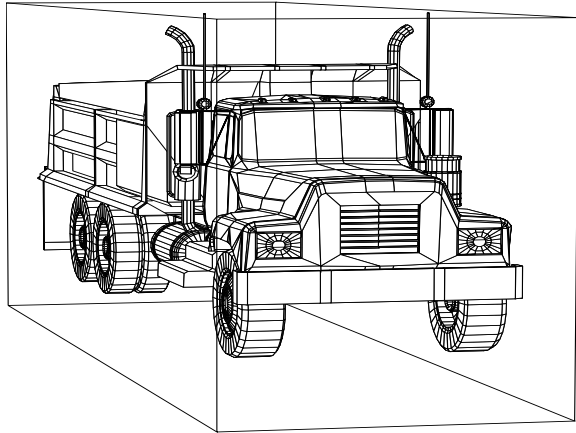

Projection Types and Camera Location

By default, MATLAB adjusts the `CameraPosition`, `CameraTarget`, and `CameraViewAngle` properties to point the camera at the center of the scene and to include all graphics objects in the axes. If you position the camera so that there are graphics objects behind the camera, the scene displayed can be affected by both the axes `Projection` property and the figure `Renderer` property. The following summarizes the interactions between projection type and rendering method.

	Orthographic	Perspective
Z-buffer	CameraViewAngle determines extent of scene at CameraTarget.	CameraViewAngle determines extent of scene from CameraPosition to infinity.
Painters	All objects are displayed regardless of CameraPosition.	Not recommended if graphics objects are behind the CameraPosition.

This diagram illustrates what you see (gray area) when using orthographic projection and Z-buffer. Anything in front of the camera is visible.

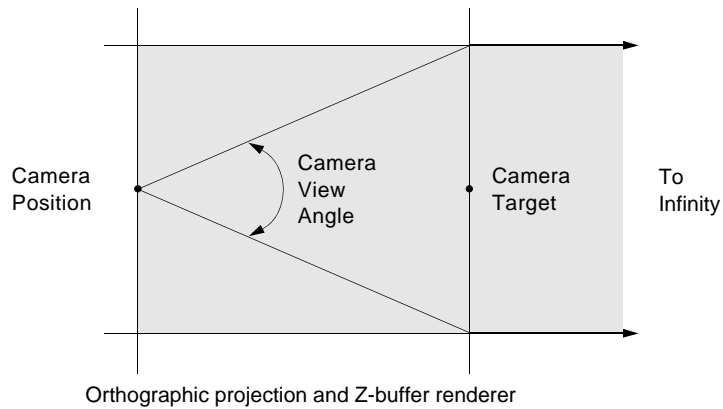

In perspective projection, you see only what is visible in the cone of the camera view angle.

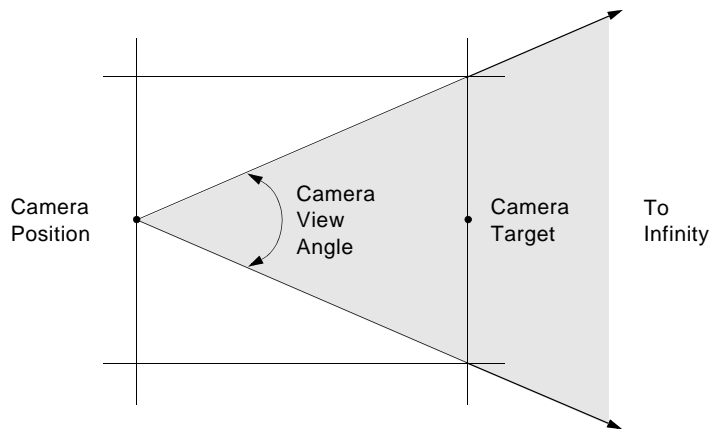

Perspective projection and Z-buffer renderer

Painters rendering method is less suited to moving the camera in 3-D space because MATLAB does not clip along the viewing axis. Orthographic projection in painters method results in all objects contained in the scene being visible regardless of the camera position.

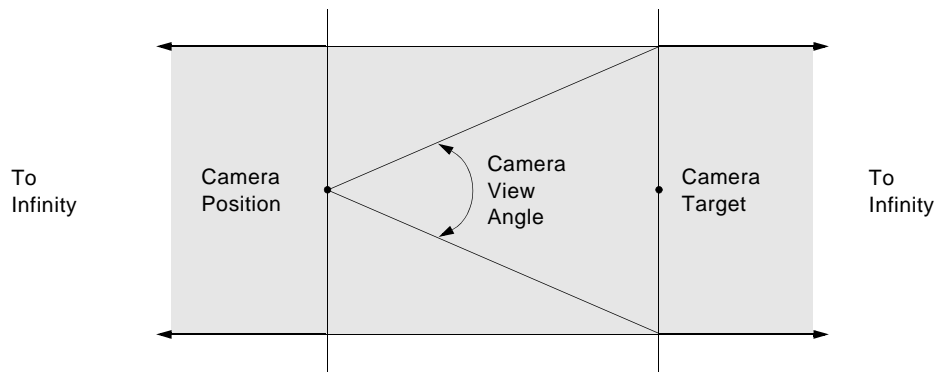

Orthographic projection and painters renderer

Printing 3-D Scenes

The same effects described in the previous section occur in hardcopy output. However, because of the differences in the process of rendering to the screen

and to a printing format, MATLAB might render using Z-buffer and generate printed output using painters. You might need to specify Z-buffer printing explicitly to obtain the results displayed on the screen (use the `-zbuffer` option with the `print` command).

Additional Information

See “Basic Printing and Exporting” and “Selecting a Renderer” in Figure Properties in the Using MATLAB Graphics documentation for information on printing and rendering methods.

Understanding Axes Aspect Ratio

Axes shape graphics objects by setting the scaling and limits of each axis. When you create a graph, MATLAB automatically determines axis scaling based on the values or size of the plotted data, and then draws the axes to fit the space available for display. Axes aspect ratio properties control how MATLAB performs the scaling required to create a graph.

This section discusses MATLAB default behavior as well as techniques for customizing graphs.

Stretch-to-Fill

By default, the size of the axes MATLAB creates for plotting is normalized to the size of the figure window (but is slightly smaller to allow for borders). If you resize the figure, the size and possibly the aspect ratio (the ratio of width to height) of the axes changes proportionally. This enables the axes to always fill the available space in the window. MATLAB also sets the x -, y -, and z -axis limits to provide the greatest resolution in each direction, again optimizing the use of available space.

This stretch-to-fill behavior is generally desirable; however, you might want to control this process to produce specific results. For example, images need to be displayed in correct proportions regardless of the aspect ratio of the figure window, or you might want graphs always to be a particular size on a printed page.

Specifying Axis Scaling

The `axis` command enables you to adjust the scaling of graphs. By default, MATLAB finds the maxima and minima of the plotted data and chooses appropriate axes ranges. You can override the defaults by setting axis limits.

```
axis([xmin xmax ymin ymax zmin zmax])
```

You can control how MATLAB scales the axes with predefined axis options:

- `axis auto` returns the axis scaling to its default, automatic mode. `v = axis` saves the scaling of the axes of the current plot in vector `v`. For subsequent graphics commands to have these same axis limits, follow them with `axis(v)`.

- `axis manual` freezes the scaling at the current limits. If you then set `hold on`, subsequent plots use the current limits. Specifying values for axis limits also sets axis scaling to manual.
- `axis tight` sets the axis limits to the range of the data.
- `axis ij` places MATLAB into its “matrix” axes mode. The coordinate system origin is at the upper left corner. The i -axis is vertical and is numbered from top to bottom. The j -axis is horizontal and is numbered from left to right.
- `axis xy` places MATLAB into its default Cartesian axes mode. The coordinate system origin is at the lower left corner. The x -axis is horizontal and is numbered from left to right. The y -axis is vertical and is numbered from bottom to top.

Specifying Aspect Ratio

The `axis` command enables you to adjust the aspect ratio of graphs. Normally MATLAB stretches the axes to fill the window. In many cases, it is more useful to specify the aspect ratio of the axes based on a particular characteristic such as the relative length or scaling of each axis. The `axis` command provides a number of useful options for adjusting the aspect ratio:

- `axis equal` changes the current axes scaling so that equal tick mark increments on the x -, y -, and z -axis are equal in length. This makes the surface displayed by `surf` look like a sphere instead of an ellipsoid. `axis equal` overrides stretch-to-fill behavior.
- `axis square` makes each axis the same length and overrides stretch-to-fill behavior.
- `axis vis3d` freezes aspect ratio properties to enable rotation of 3-D objects and overrides stretch-to-fill. Use this option after other axis options to keep settings from changing while you rotate the scene.
- `axis image` makes the aspect ratio of the axes the same as the image.
- `axis auto` returns the x -, y -, and z -axis limits to automatic selection mode.
- `axis normal` restores the current axis box to full size and removes any restrictions on the scaling of the units. It undoes the effects of `axis square`. Used in conjunction with `axis auto`, it undoes the effects of `axis equal`.

The `axis` command works by manipulating axes graphics object properties.

Example – axis Command Options

The following three pictures illustrate the effects of three axis options on a cylindrical surface created with the statements

```
t = 0:pi/6:4*pi;
[x,y,z] = cylinder(4+cos(t),30);
surf(x,y,z)
```

`axis normal` is the default behavior. MATLAB automatically sets the axis limits to span the data range along each axis and stretches the plot to fit the figure window.

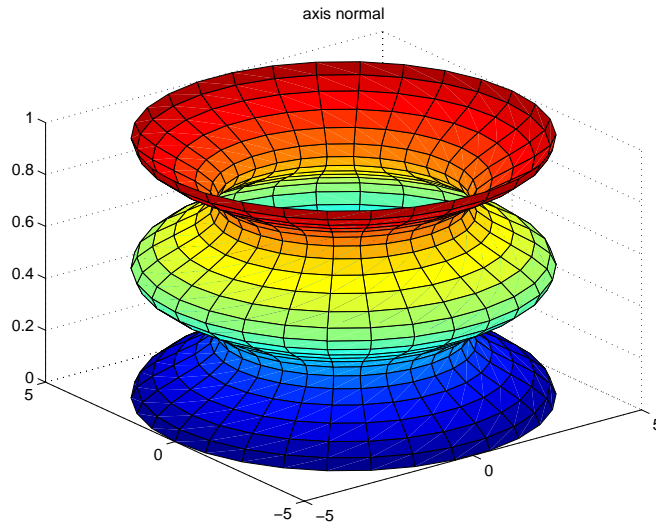

`axis square` creates an axes that is square regardless of the shape of the figure window. The cylindrical surface is no longer distorted because it is not warped to fit the window. However, the size of one data unit is not equal along all axes (the z -axis spans only one unit while the x -axes and y -axes span 10 units each).

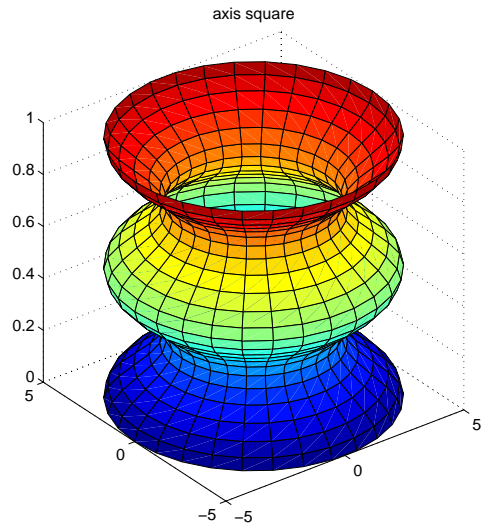

axis equal makes the length of one data unit equal along each axis while maintaining a nearly square plot box. It also prevents warping of the axis to fill the window's shape.

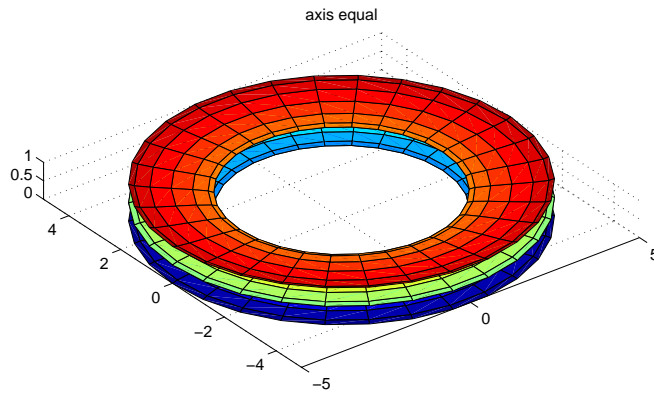

Additional Commands for Setting Aspect Ratio

You can control the aspect ratio of your graph in three ways:

- Specifying the relative scales of the x -, y -, and z -axes (data aspect ratio)
- Specifying the shape of the space defined by the axes (plot box aspect ratio)
- Specifying the axis limits

The following commands enable you to set these values.

Command	Purpose
<code>daspect</code>	Set or query the data aspect ratio
<code>pbaspect</code>	Set or query the plot box aspect ratio
<code>xlim</code>	Set or query x -axis limits
<code>ylim</code>	Set or query y -axis limits
<code>zlim</code>	Set or query z -axis limits

See “Axes Aspect Ratio Properties” on page 12-44 for a list of the axes properties that control aspect ratio.

Axes Aspect Ratio Properties

The `axis` command works by setting various axes object properties. You can set these properties directly to achieve precisely the effect you want.

Property	Description
<code>DataAspectRatio</code>	Sets the relative scaling of the individual axis data values. Set <code>DataAspectRatio</code> to <code>[1 1 1]</code> to display real-world objects in correct proportions. Specifying a value for <code>DataAspectRatio</code> overrides stretch-to-fill behavior.
<code>DataAspectRatioMode</code>	In auto, MATLAB selects axis scales that provide the highest resolution in the space available.
<code>PlotBoxAspectRatio</code>	Sets the proportions of the axes plot box (set <code>box to on</code> to see the box). Specifying a value for <code>PlotBoxAspectRatio</code> overrides stretch-to-fill behavior.
<code>PlotBoxAspectRatioMode</code>	In auto, MATLAB sets the <code>PlotBoxAspectRatio</code> to <code>[1 1 1]</code> unless you explicitly set the <code>DataAspectRatio</code> and/or the axis limits.
<code>Position</code>	Defines the location and size of the axes with a four-element vector: <i>[left offset, bottom offset, width, height]</i> .
<code>XLim, YLim, ZLim</code>	Sets the minimum and maximum limits of the respective axes.
<code>XLimMode, YLimMode, ZLimMode</code>	In auto, MATLAB selects the axis limits.

By default, MATLAB automatically determines values for all of these properties (i.e., all the modes are auto) and then applies stretch-to-fill. You can override any property's automatic operation by specifying a value for the property or setting its mode to manual. The value you select for a particular property depends primarily on what type of data you want to display.

Much of the data visualized with MATLAB is either

- Numerical data displayed as line or mesh plots
- Representations of real-world objects (e.g., a dump truck or a section of the earth's topography)

In the first case, it is generally desirable to select axis limits that provide good resolution in each axis direction and to fill the available space. Real-world objects, on the other hand, need to be represented accurately in proportion, regardless of the angle of view.

Default Aspect Ratio Selection

There are two key elements to MATLAB default behavior — normalizing the axes size to the window size and stretch-to-fill.

The axes `Position` property specifies the location and dimensions of the axes. The third and fourth elements of the `Position` vector (width and height) define a rectangle in which MATLAB draws the axes (indicated by the dotted line in the following pictures). MATLAB stretches the axes to fill this rectangle.

The default value for the axes `Units` property is normalized to the parent figure dimensions. This means the shape of the figure window determines the shape of the position rectangle. As you change the size of the window, MATLAB reshapes the position rectangle to fit it.

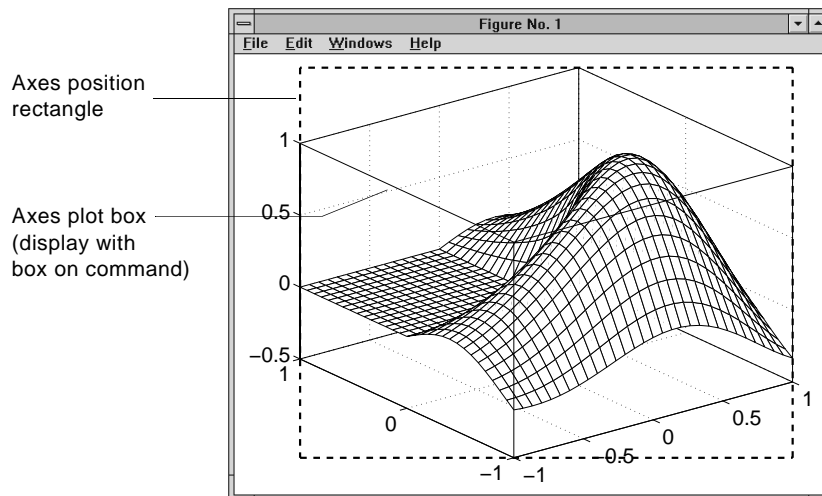

The view is the 2-D projection of the plot box onto the screen.

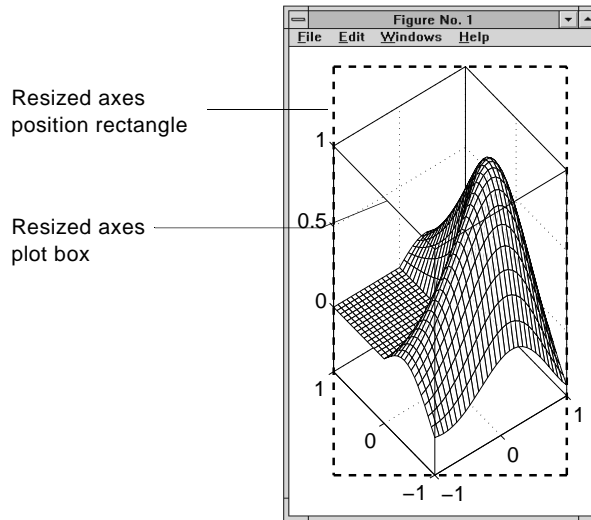

As you can see, reshaping the axes to fit into the figure window can change the aspect ratio of the graph. MATLAB applies stretch-to-fill so the axes fill the position rectangle and in the process can distort the shape. This is generally desirable for graphs of numeric data, but not for displaying objects realistically.

Example — MATLAB Defaults

MATLAB surface plots are well suited for visualizing mathematical functions of two variables. For example, to display a mesh plot of the function $z = xe^{x^2 y^2}$ evaluated over the range $-2 \leq x \leq 2$, $-4 \leq y \leq 4$, use the statements

```
[X,Y] = meshgrid([ 2:.15:2],[ 4:.3:4]);
Z = X.*exp( X.^2 Y.^2);
mesh(X,Y,Z)
```

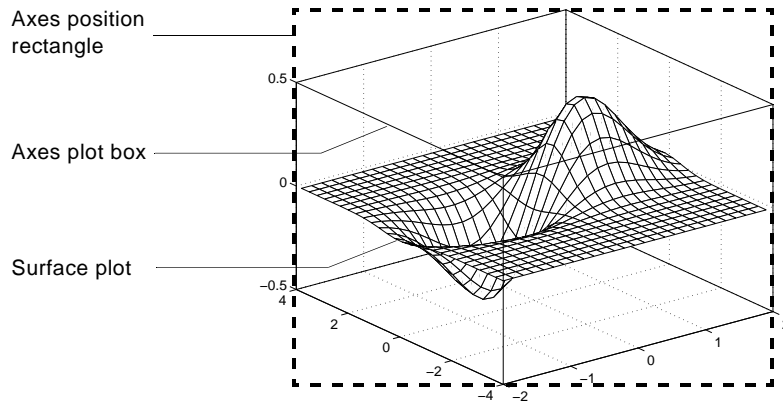

The MATLAB default property values are designed to

- Select axis limits to span the range of the data (XLimMode, YLimMode, and ZLimMode are set to auto).
- Provide the highest resolution in the available space by setting the scale of each axis independently (DataAspectRatioMode and the PlotBoxAspectRatioMode are set to auto).
- Draw axes that fit the position rectangle by adjusting the CameraViewAngle and then stretch-to-fill the axes if necessary.

Overriding Stretch-to-Fill

To maintain a particular shape, you can specify the size of the axes in absolute units such as inches, which are independent of the figure window size. However, this is not a good approach if you are writing an M-file that you want to work with a figure window of any size. A better approach is to specify the aspect ratio of the axes and override automatic stretch-to-fill.

In cases where you want a specific aspect ratio, you can override stretching by specifying a value for these axes properties:

- DataAspectRatio or DataAspectRatioMode
- PlotBoxAspectRatio or PlotBoxAspectRatioMode
- CameraViewAngle or CameraViewAngleMode

The first two sets of properties affect the aspect ratio directly. Setting either of the mode properties to manual simply disables stretch-to-fill while maintaining all current property values. In this case, MATLAB enlarges the axes until one dimension of the position rectangle constrains it.

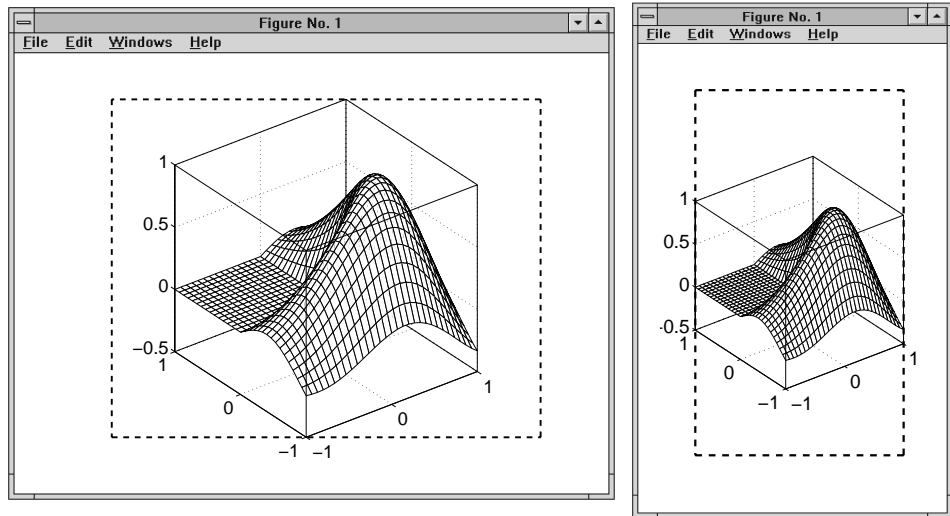

Setting the `CameraViewAngle` property disables stretch-to-fill, and also prevents MATLAB from readjusting the size of the axes if you change the view.

Effects of Setting Aspect Ratio Properties

It is important to understand how properties interact with each other, in order to obtain the results you want. The `DataAspectRatio`, `PlotBoxAspectRatio`, and the x -, y -, and z -axis limits (`XLim`, `YLim`, and `ZLim` properties) all place constraints on the shape of the axes.

Data Aspect Ratio

The `DataAspectRatio` property controls the ratio of the axis scales. For a mesh plot of the function $z = xe^{x^2}y^2$ evaluated over the range $-2 \leq x \leq 2$, $-4 \leq y \leq 4$

```
[X,Y] = meshgrid([ 2:.15:2],[ 4:.3:4]);
Z = X.*exp( X.^2 Y.^2);
mesh(X,Y,Z)
```

the values are

```
get(gca, 'DataAspectRatio')
ans =
    4  8  1
```

This means that four units in length along the x -axis cover the same data values as eight units in length along the y -axis and one unit in length along the z -axis. The axes fill the plot box, which has an aspect ratio of [1 1 1] by default.

If you want to view the mesh plot so that the relative magnitudes along each axis are equal with respect to each other, you can set the `DataAspectRatio` to [1 1 1].

```
set(gca, 'DataAspectRatio', [1 1 1])
```

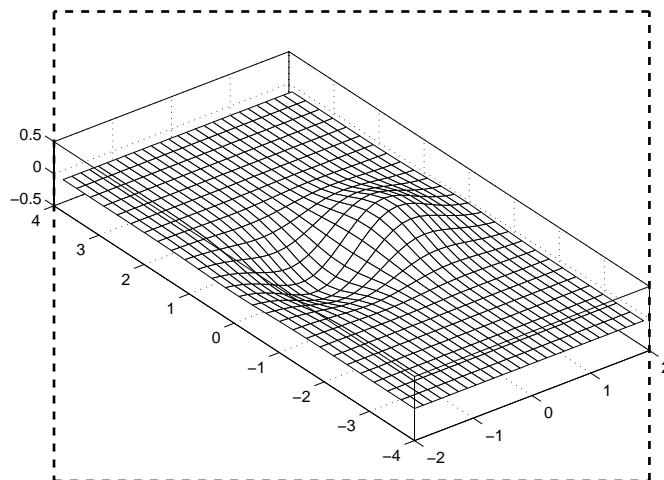

Setting the value of the `DataAspectRatio` property also sets the `DataAspectRatioMode` to `manual` and overrides `stretch-to-fill` so the specified aspect ratio is achieved.

Plot Box Aspect Ratio

Looking at the value of the `PlotBoxAspectRatio` for the graph in the previous section shows that it has now taken on the former value of the `DataAspectRatio`.

```
get(gca, 'PlotBoxAspectRatio')  
ans =  
    4  8  1
```

MATLAB has rescaled the plot box to accommodate the graph using the specified `DataAspectRatio`.

The `PlotBoxAspectRatio` property controls the shape of the axes plot box. MATLAB sets this property to `[1 1 1]` by default and adjusts the `DataAspectRatio` property so that graphs fill the plot box if stretching is on, or until reaching a constraint if stretch-to-fill has been overridden.

When you set the value of the `DataAspectRatio` and thereby prevent it from changing, MATLAB varies the `PlotBoxAspectRatio` instead. If you specify both the `DataAspectRatio` and the `PlotBoxAspectRatio`, MATLAB is forced to change the axis limits to obey the two constraints you have already defined.

Continuing with the mesh example, if you set both properties,

```
set(gca, 'DataAspectRatio', [1 1 1], ...  
        'PlotBoxAspectRatio', [1 1 1])
```

MATLAB changes the axis limits to satisfy the two constraints placed on the axes.

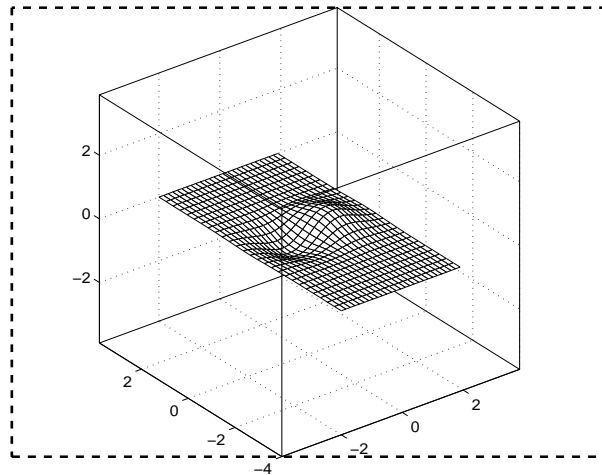

Adjusting Axis Limits

MATLAB enables you to set the axis limits to the values you want. However, specifying a value for `DataAspectRatio`, `PlotBoxAspectRatio`, and the axis limits overconstrains the axes definition. For example, it is not possible for MATLAB to draw the axes if you set these values:

```
set(gca, 'DataAspectRatio', [1 1 1], ...
        'PlotBoxAspectRatio', [1 1 1], ...
        'XLim', [-4 4], ...
        'YLim', [-4 4], ...
        'ZLim', [-1 1])
```

In this case, MATLAB ignores the setting of the `PlotBoxAspectRatio` and determines its value automatically. These particular values cause the `PlotBoxAspectRatio` to return to its calculated value.

```
get(gca, 'PlotBoxAspectRatio')
ans =
    4 8 1
```

MATLAB can now draw the axes using the specified `DataAspectRatio` and axis limits.

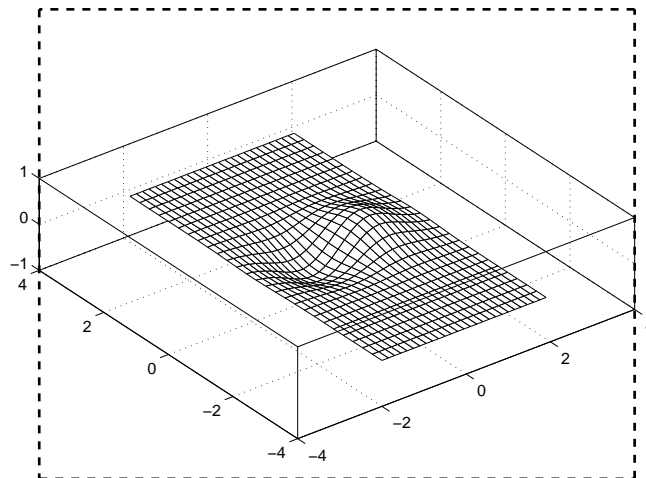

Example – Displaying Real Objects

If you want to display an object so that it looks realistic, you need to change MATLAB defaults. For example, this data defines a wedge-shaped patch object.

```
vertex_list =           vertex_connection =
    0     0     0         1     2     3     4
    0     1     0         2     6     7     3
    1     1     0         4     3     7     8
    1     0     0         1     5     8     4
    0     0     1         1     2     6     5
    0     1     1         5     6     7     8
    1     1     4
    1     0     4
```

```
patch('Vertices',vertex_list,'Faces',vertex_connection,...
      'FaceColor','w','EdgeColor','k')
view(3)
```

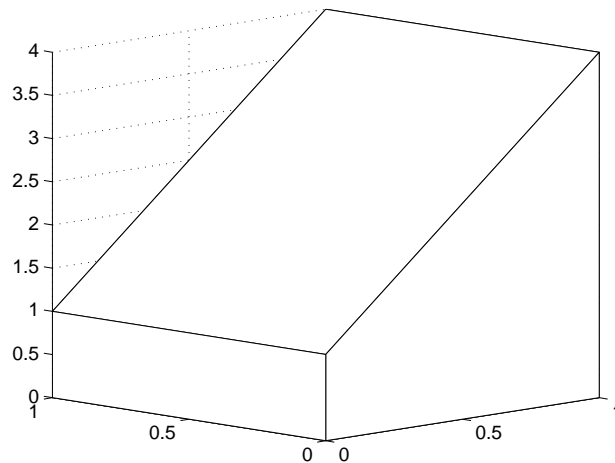

However, this axes distorts the actual shape of the solid object defined by the data. To display it in correct proportions, set the `DataAspectRatio`.

```
set(gca, 'DataAspectRatio', [1 1 1])
```

The units are now equal in the x -, y -, and z -directions and the axes is not being stretched to fill the position rectangle, revealing the true shape of the object.

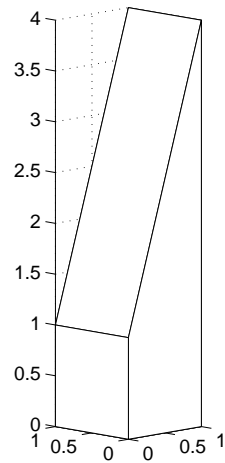

Lighting as a Visualization Tool

Lighting Overview (p. 13-2)	Contains links to examples throughout the graphics documentation that illustrate the use of lighting
Lighting Commands (p. 13-3)	Commands for creating lighting effects
Light Objects (p. 13-4)	Creation and properties of light objects
Adding Lights to a Scene (p. 13-5)	Examples of how to position lights and set properties
Properties That Affect Lighting (p. 13-8)	Properties of axes, patches, and surfaces that affect lights
Selecting a Lighting Method (p. 13-10)	Illustration of various lighting methods showing which to use
Reflectance Characteristics of Graphics Objects (p. 13-11)	Catalog illustrating various lighting characteristics

Lighting Overview

Lighting is a technique for adding realism to a graphical scene. It does this by simulating the highlights and dark areas that occur on objects under natural lighting (e.g., the directional light that comes from the sun). To create lighting effects, MATLAB defines a graphics object called a light. MATLAB applies lighting to surface and patch objects.

Lighting Examples

These examples illustrate the use of lighting in a visualization context.

- Tracing a stream line through a volume — Sets properties of surfaces, patches, and lights. See “Example — Creating a Fly-Through” in “Defining the View” in the Using MATLAB Graphics documentation.
- Using slice planes and cone plots — Sets lighting characteristics of objects in a scene independently to achieve a desired result. See the `coneplot` function.
- Lighting multiple slice planes independently to visualize fluid flow. See “Example — Slicing Fluid Flow Data” in Volume Visualization Techniques in the Using MATLAB Graphics documentation.
- Combining single-color lit surfaces with interpolated coloring. See “Example — Visualizing MRI Data” in Volume Visualization Techniques in the Using MATLAB Graphics documentation.
- Employing lighting to reveal surface shape. The fluid flow isosurface example and the surface plot of the `sinc` function examples illustrate this technique. See “Example — Isosurfaces in Fluid Flow Data” in Volume Visualization Techniques and “Visualizing Functions of Two Variables” in Creating 3-D Graphs in the Using MATLAB Graphics documentation.

Lighting Commands

MATLAB provides commands that enable you to position light sources and adjust the characteristics of lit objects. These commands include the following.

Command	Purpose
<code>camlight</code>	Create or move a light with respect to the camera position
<code>lightangle</code>	Create or position a light in spherical coordinates
<code>light</code>	Create a light object
<code>lighting</code>	Select a lighting method
<code>material</code>	Set the reflectance properties of lit objects

You might find it useful to set light or lit-object properties directly to achieve specific results. In addition to the material in this topic area, you can explore the following lighting examples as an introduction to lighting for visualization.

Light Objects

You create a light object using the `light` function. Three important light object properties are

- **Color** — Color of the light cast by the light object
- **Style** — Either infinitely far away (the default) or local
- **Position** — Direction (for infinite light sources) or the location (for local light sources)

The **Color** property determines the color of the directional light from the light source. The color of an object in a scene is determined by the color of the object and the light source.

The **Style** property determines whether the light source is a point source (**Style** set to `local`), which radiates from the specified position in all directions, or a light source placed at infinity (**Style** set to `infinite`), which shines from the direction of the specified position with parallel rays.

The **Position** property specifies the location of the light source in axes data units. In the case of a light source at infinity, **Position** specifies the direction to the light source.

Lights affect surface and patch objects that are in the same axes as the light. These objects have a number of properties that alter the way they look when illuminated by lights.

Adding Lights to a Scene

This example displays the membrane surface and illuminates it with a light source emanating from the direction defined by the position vector $[0 \ -2 \ 1]$. This vector defines a direction from the axes origin passing through the point with the coordinates $0, -2, 1$. The light shines from this direction toward the axes origin.

```
membrane
light('Position',[0 -2 1])
```

Creating a light activates a number of lighting-related properties controlling characteristics such as the ambient light and reflectance properties of objects. It also switches to Z-buffer renderer if not already in that mode.

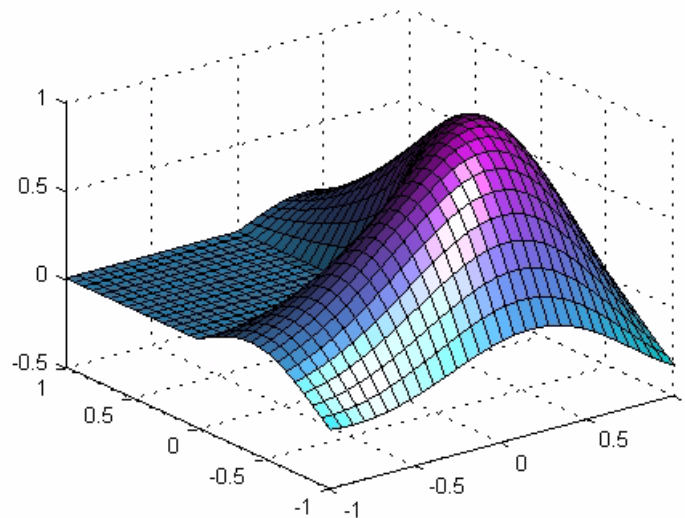

Illuminating Mathematical Functions

Lighting can enhance surface graphs of mathematical functions. For example, use the `ezsurf` command to evaluate the expression

$$\frac{\sqrt{x^2 + y^2}}{\sqrt{x^2 + y^2}} \quad \text{over the region } -6\pi \text{ to } 6\pi.$$

```
ezsurf('sin(sqrt(x^2+y^2))/sqrt(x^2+y^2)',[-6*pi,6*pi])
```

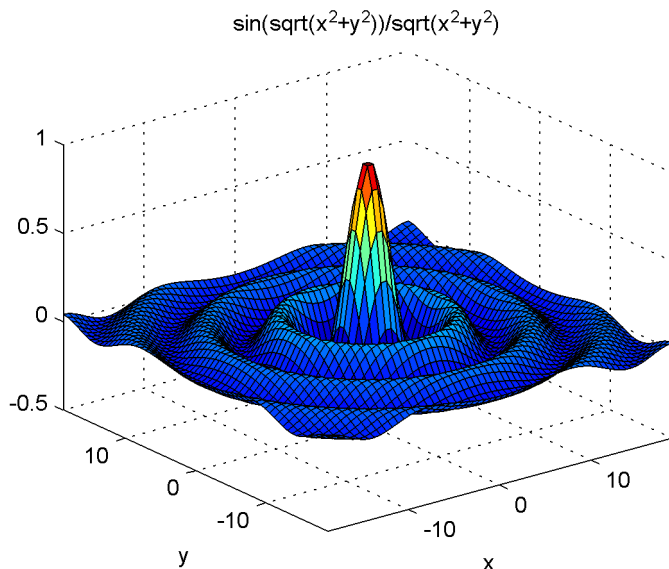

Now add lighting using the `lightangle` command, which accepts the light position in terms of azimuth and elevation.

```
view(0,75)
shading interp
lightangle(-45,30)
set(gcf,'Renderer','zbuffer')
set(findobj(gca,'type','surface'),...
    'FaceLighting','phong',...
    'AmbientStrength',.3,'DiffuseStrength',.8,...
    'SpecularStrength',.9,'SpecularExponent',25,...
    'BackFaceLighting','unlit')
```

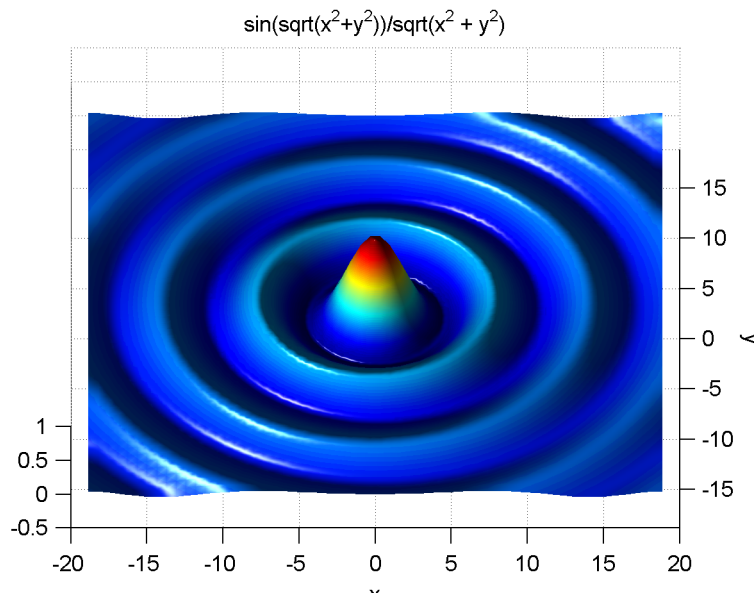

After obtaining the surface object's handle using `f indobj`, you can set properties that affect how the light reflects from the surface. See “Properties That Affect Lighting” on page 13-8 for more detailed descriptions of these properties.

Properties That Affect Lighting

You cannot see light objects themselves, but you can see their effects on any patch and surface objects present in the axes containing the light. A number of functions create these objects, including `surf`, `mesh`, `pcolor`, `fill`, and `fill3` as well as the surface and patch functions.

You control lighting effects by setting various axes, light, patch, and surface object properties. All properties have default values that generally produce desirable results. However, you can achieve the specific effect you want by adjusting the values of these properties.

Property	Effect
<code>AmbientLightColor</code>	An axes property that specifies the color of the background light in the scene, which has no direction and affects all objects uniformly. Ambient light effects occur only when there is a visible light object in the axes.
<code>AmbientStrength</code>	A patch and surface property that determines the intensity of the ambient component of the light reflected from the object.
<code>DiffuseStrength</code>	A patch and surface property that determines the intensity of the diffuse component of the light reflected from the object.
<code>SpecularStrength</code>	A patch and surface property that determines the intensity of the specular component of the light reflected from the object.
<code>SpecularExponent</code>	A patch and surface property that determines the size of the specular highlight.
<code>SpecularColorReflectance</code>	A patch and surface property that determines the degree to which the specularly reflected light is colored by the object color or the light source color.
<code>FaceLighting</code>	A patch and surface property that determines the method used to calculate the effect of the light on the faces of the object. Choices are either no lighting, or flat, Gouraud, or Phong lighting algorithms.

Property	Effect
EdgeLighting	A patch and surface property that determines the method used to calculate the effect of the light on the edges of the object. Choices are either no lighting, or flat, Gouraud, or Phong lighting algorithms.
BackFaceLighting	A patch and surface property that determines how faces are lit when their vertex normals point away from the camera. This property is useful for discriminating between the internal and external surfaces of an object.
FaceColor	A patch and surface property that specifies the color of the object faces.
EdgeColor	A patch and surface property that specifies the color of the object edges.
VertexNormals	A patch and surface property that contains normal vectors for each vertex of the object. MATLAB uses vertex normal vectors to perform lighting calculations. While MATLAB automatically generates this data, you can also specify your own vertex normals.
NormalMode	A patch and surface property that determines whether MATLAB recalculates vertex normals if you change object data (auto) or uses the current values of the VertexNormals property (manual). If you specify values for VertexNormals, MATLAB sets this property to manual.

See a description of all axes, surface, and patch object properties.

Selecting a Lighting Method

When you add lights to an axes, MATLAB determines the effects these lights have on the patch and surface objects that are displayed in that axes. There are different methods used to calculate the face and edge coloring of lit objects, and the one you select depends on the results you want to obtain.

Face and Edge Lighting Methods

MATLAB supports three different algorithms for lighting calculations, selected by setting the `FaceLighting` and `EdgeLighting` properties of each patch and surface object in the scene. Each algorithm produces somewhat different results:

- Flat lighting — Produces uniform color across each of the faces of the object. Select this method to view faceted objects.
- Gouraud lighting — Calculates the colors at the vertices and then interpolates colors across the faces. Select this method to view curved surfaces.
- Phong lighting — Interpolates the vertex normals across each face and calculates the reflectance at each pixel. Select this choice to view curved surfaces. Phong lighting generally produces better results than Gouraud lighting, but takes longer to render.

This illustration shows how a red sphere looks using each of the lighting methods with one white light source.

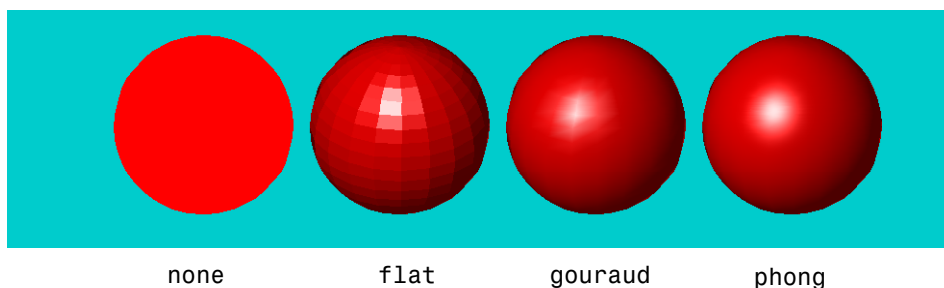

The `lighting` command (as opposed to the `light` function) provides a convenient way to set the lighting method.

Reflectance Characteristics of Graphics Objects

You can modify the reflectance characteristics of patch and surface objects and thereby change the way they look when lights are applied to the scene. The characteristics discussed in this section include

- Specular and diffuse reflection
- Ambient light
- Specular exponent
- Specular color reflectance
- Backface lighting

It is likely you will adjust these characteristics in combination to produce particular results.

Also see the `material` command for a convenient way to produce certain lighting effects.

Specular and Diffuse Reflection

You can control the amount of specular and diffuse reflection from the surface of an object by setting the `SpecularStrength` and `DiffuseStrength` properties. This picture illustrates various settings.

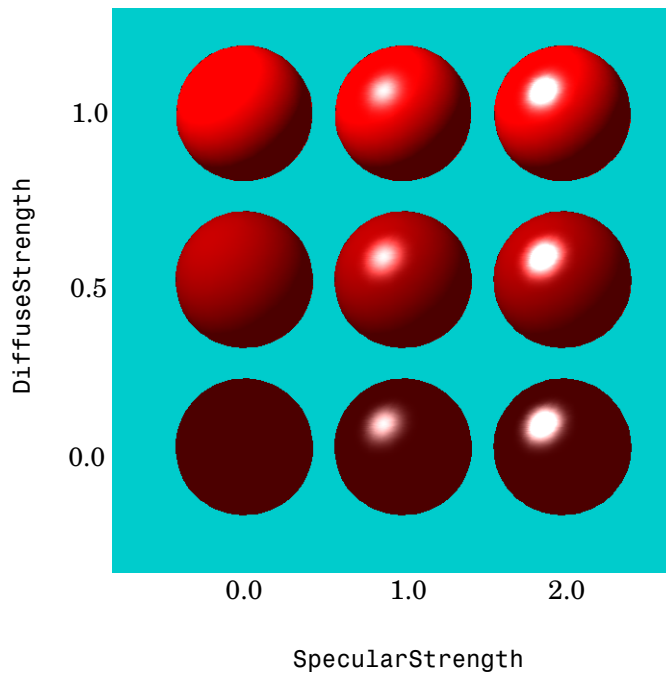

Ambient Light

Ambient light is a directionless light that shines uniformly on all objects in the scene. Ambient light is visible only when there are light objects in the axes. There are two properties that control ambient light — `AmbientLightColor` is an axes property that sets the color, and `AmbientStrength` is a property of patch and surface objects that determines the intensity of the ambient light on the particular object.

This illustration shows three different ambient light colors at various intensities. The sphere is red and there is a white light object present.

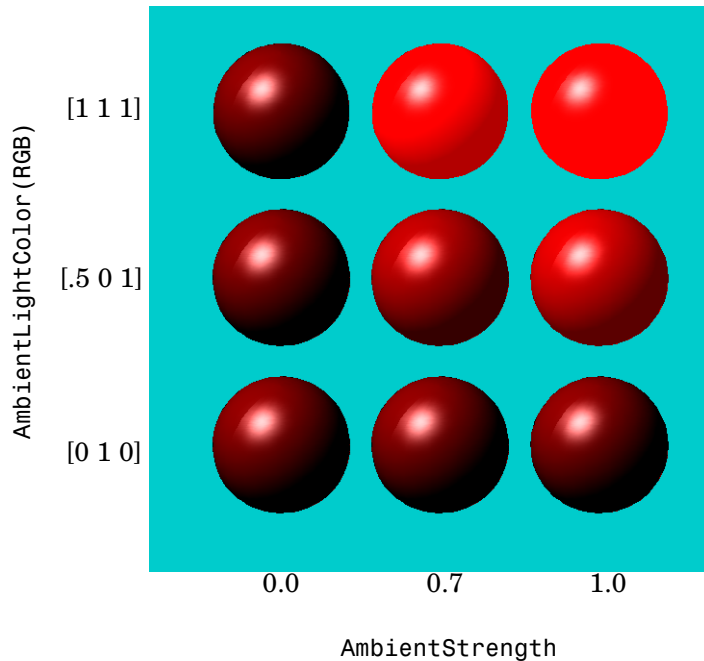

The green $[0\ 1\ 0]$ ambient light does not affect the scene because there is no red component in green light. However, the color defined by the RGB values $[\.5\ 0\ 1]$ does have a red component, so it contributes to the light on the sphere (but less than the white $[1\ 1\ 1]$ ambient light).

Specular Exponent

The size of the specular highlight spot depends on the value of the patch and surface object's `SpecularExponent` property. Typical values for this property range from 1 to 500, with normal objects having values in the range 5 to 20.

This illustration shows a red sphere illuminated by a white light with three different values for the `SpecularExponent` property.

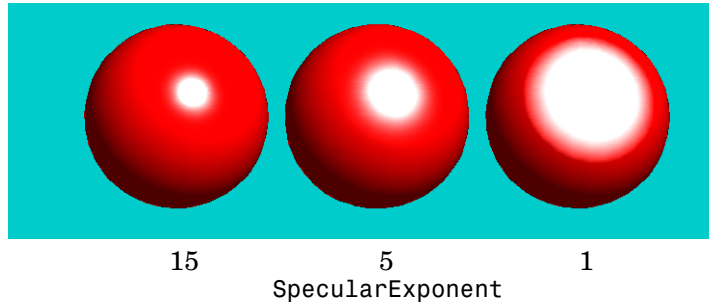

Specular Color Reflectance

The color of the specularly reflected light can range from a combination of the color of the object and the color of the light source to the color of the light source only. The patch and surface `SpecularColorReflectance` property controls this color. This illustration shows a red sphere illuminated by a white light. The values of the `SpecularColorReflectance` property range from 0 (object and light color) to 1 (light color).

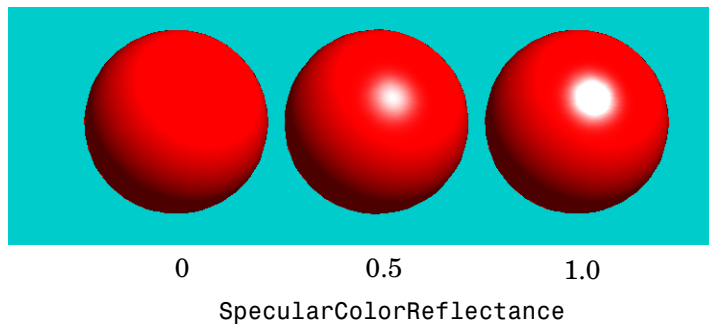

Back Face Lighting

Back face lighting is useful for showing the difference between internal and external faces. These pictures of cut-away cylindrical surfaces illustrate the effects of back face lighting.

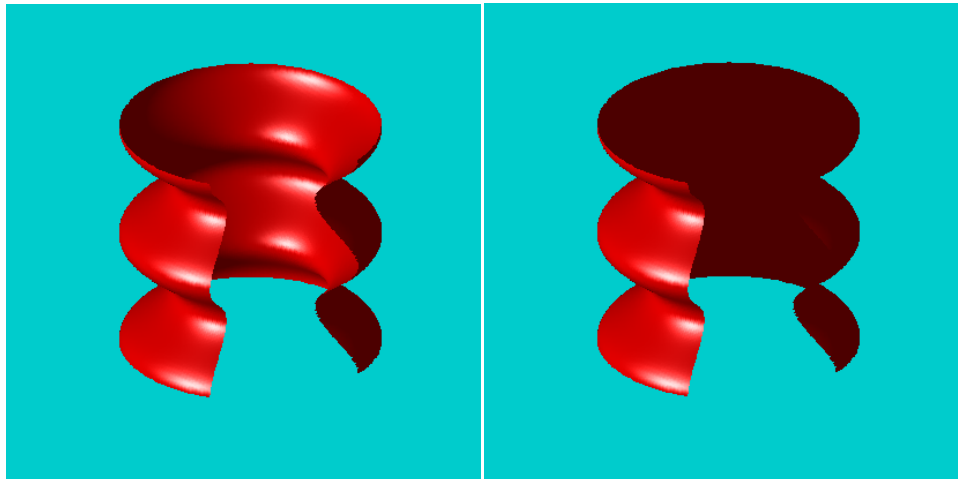

BackFaceLighting = reverselit

BackFaceLighting = unlit

The default value for `BackFaceLighting` is `reverselit`. This setting reverses the direction of the vertex normals that face away from the camera, causing the interior surface to reflect light towards the camera. Setting `BackFaceLighting` to `unlit` disables lighting on faces with normals that point away from the camera.

You can also use `BackFaceLighting` to remove edge effects for closed objects. These effects occur when `BackFaceLighting` is set to `reverselit` and pixels along the edge of a closed object are lit as if their vertex normals faced the camera. This produces an improperly lit pixel because the pixel is visible but is really facing away from the camera.

To illustrate this effect, the next picture shows a blowup of the edge of a lit sphere. Setting `BackFaceLighting` to `lit` prevents the improper lighting of pixels.

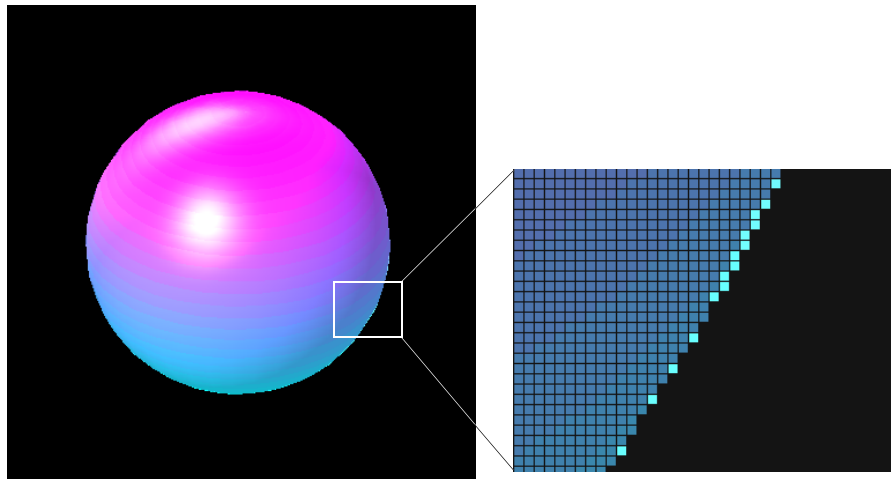

`BackFaceLighting = reverselit`

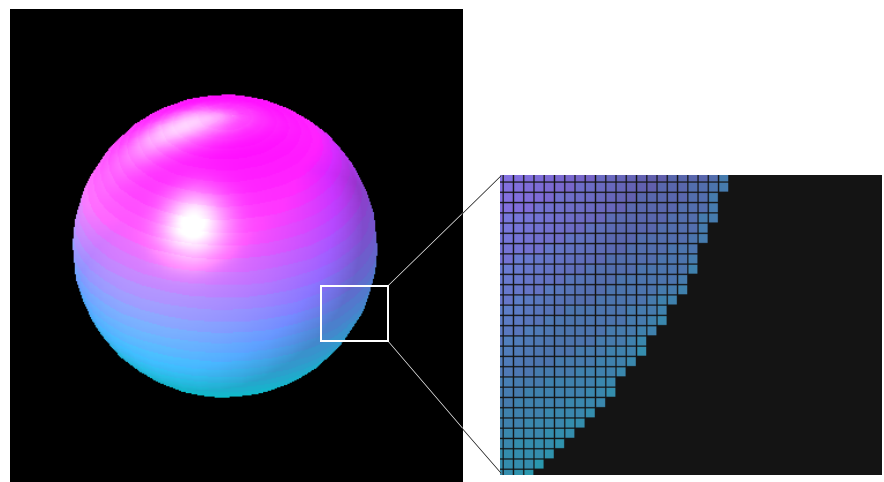

`BackFaceLighting = lit`

Positioning Lights in Data Space

This example creates a sphere and a cube to illustrate the effects of various properties on lighting. The variables `vert` and `fac` define the cube using the `patch` function.

```

vert =
    1    1    1
    1    2    1
    2    2    1
    2    1    1
    1    1    2
    1    2    2
    2    2    2
    2    1    2

fac =
    1    2    3    4
    2    6    7    3
    4    3    7    8
    1    5    8    4
    1    2    6    5
    5    6    7    8

```

```

sphere(36);
h = findobj('Type','surface');
set(h,'FaceLighting','phong',...
    'FaceColor','interp',...
    'EdgeColor',[.4 .4 .4],...
    'BackFaceLighting','lit')
hold on
patch('faces',fac,'vertices',vert,'FaceColor','y');
light('Position',[1 3 2]);
light('Position',[-3 -1 3]);
material shiny
axis vis3d off
hold off

```

All faces of the cube have `FaceColor` set to yellow. The `sphere` function creates a spherical surface and the handle of this surface is obtained using `findobj` to search for the object whose `Type` property is `surface`. The `light` functions define two white (the default color) light objects located at infinity in the direction specified by the `Position` vectors. These vectors are defined in axes coordinates $[x, y, z]$.

The `patch` uses `flat` `FaceLighting` (the default) to enhance the visibility of each side. The surface uses `phong` `FaceLighting` because it produces the smoothest interpolation of lighting effects. The `material shiny` command

affects the reflectance properties of both the cube and sphere (although its effects are noticeable only on the sphere because of the cube's flat shading).

Because the sphere is closed, the `BackFaceLighting` property is changed from its default setting, which reverses the direction of vertex normals that face away from the camera, to normal lighting, which removes undesirable edge effects.

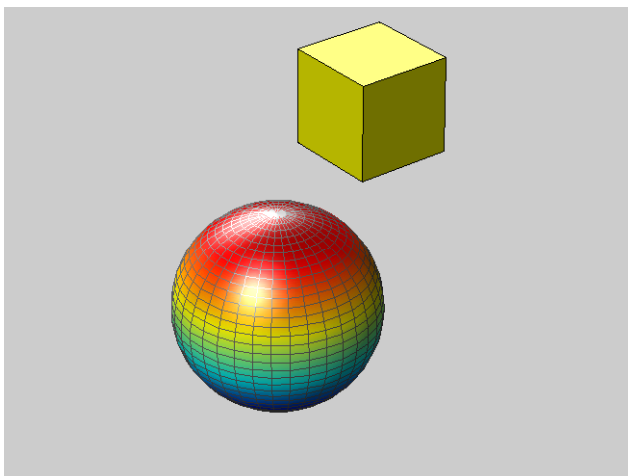

Examining the code in the `lighting` and `material M-files` can help you understand how various properties affect lighting.

Transparency

Making Objects Transparent (p. 14-2)	Overview of the object properties that specify transparency
Specifying a Single Transparency Value (p. 14-5)	How to specify a transparency value that applies to all the faces of a graphics object
Mapping Data to Transparency — Alpha Data (p. 14-7)	How to use transparency as another dimension for visualizing data
Selecting an Alphamap (p. 14-10)	Characteristics of various alphamaps and illustrations of the effects they produce

Making Objects Transparent

Making graphics objects semitransparent is a useful technique in 3-D visualization to make it possible to see an object, while at the same time, see what information the object would obscure if it was completely opaque. You can also use transparency as another dimension for displaying data, much the way color is used in MATLAB.

The transparency of a graphics object determines the degree to which you can see through the object. You can specify a continuous range of transparency varying from completely transparent (i.e., invisible) to completely opaque (i.e., no transparency).

Objects that support transparency are

- Image
- Patch
- Surface

The following picture illustrates the effect of transparency. The green isosurface (patch object) reveals the cone plot that lies in the interior.

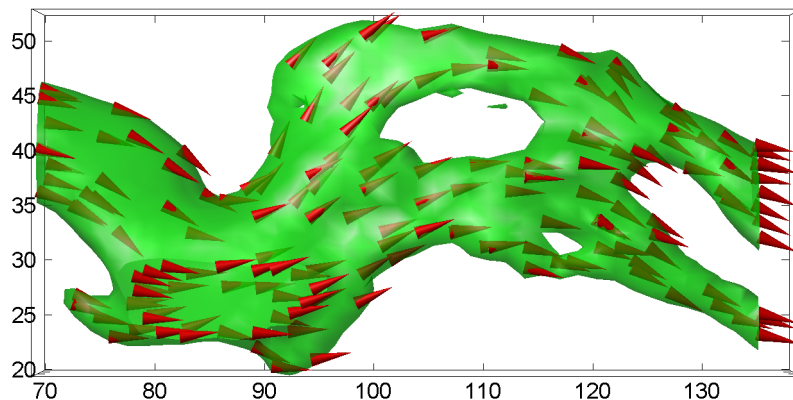

Note You must have OpenGL available on your system to use transparency. MATLAB automatically uses OpenGL if it is available. See the figure `RendererMode` property for more information.

Specifying Transparency

Transparency values, which range from [0 1], are referred to as *alpha* values. An alpha value of 0 means completely transparent (i.e., invisible); an alpha value of 1 means completely opaque (i.e., no transparency).

MATLAB treats transparency in a way that is analogous to how it treats color for the respective objects:

- Patches and surfaces can define a single face and edge alpha value or use flat or interpolated transparency based on values in the figure's alphamap.
- Images, patches, and surfaces can define alpha data that is used as indices into the alphamap or directly as alpha values.
- Axes define alpha limits that control the mapping of object data to alpha values.
- Figures contain alphamaps, which are m-by-1 arrays of alpha values.

See the following sections for more information on color:

- “Specifying Patch Coloring” in *Creating 3-D Models with Patches in the Using MATLAB Graphics* documentation
- “Coloring Mesh and Surface Plots” in *Creating 3-D Graphs in the Using MATLAB Graphics* documentation

Transparency Properties

The following table summarizes the object properties that control transparency.

Property	Purpose
AlphaData	Transparency data for image and surface objects
AlphaDataMapping	Transparency data mapping method
FaceAlpha	Transparency of the faces (patch and surface only)
EdgeAlpha	Transparency of the edges (patch and surface only)
FaceVertexAlphaData	Patch only alpha data property
ALim	Alpha axis limits
ALimMode	Alpha axis limits mode
Alphamap	Figure alphamap

Transparency Functions

There are three functions that simplify the process of setting alpha properties.

Function	Purpose
alpha	Set or query transparency properties for objects in current axes
alphamap	Specify the figure alphamap
alim	Set or query the axes alpha limits

Specifying a Single Transparency Value

Specifying a single transparency value for graphics objects is useful when you want to reveal structure that is obscured with opaque objects. For patches and surfaces, use the `FaceAlpha` and `EdgeAlpha` properties to specify the transparency of faces and edges. The following example illustrates this.

Example – Transparent Isosurface

This example uses the `flow` function to generate data for the speed profile of a submerged jet within an infinite tank. One way to visualize this data is by creating an isosurface illustrating where the rate of flow is equal to a specified value.

```
[x y z v] = flow;  
p = patch(isosurface(x,y,z,v,-3));  
isonormals(x,y,z,v,p);  
set(p,'facecolor','red','edgecolor','none');  
daspect([1 1 1]);  
view(3); axis tight; grid on;  
camlight; lighting gouraud;
```

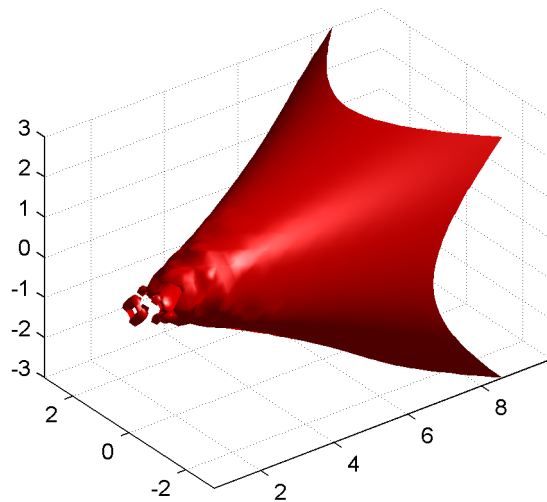

Adding transparency to the isosurface reveals that there is greater complexity in the fluid flow than is visible using the opaque surface. The statement

```
alpha(.5)
```

sets the FaceAlpha value for the isosurface face to .5.

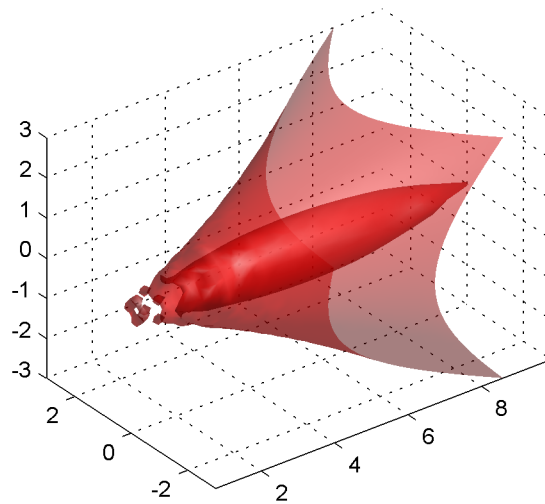

Setting a Single Transparency Value for Images

For images, the statement

```
alpha(.5)
```

sets AlphaData to .5. When the AlphaDataMapping property is set to none (the default), setting AlphaData on an image causes the entire image to be rendered with the specified alpha value.

Mapping Data to Transparency — Alpha Data

Alpha data is analogous to color data (e.g., the `CData` property of surfaces). When you create a surface, MATLAB maps each element in the color data array to a color in the colormap. Similarly, each element in the alpha data maps to a transparency value in the alphamap.

Specify surface and image alpha data with the `AlphaData` property. For patch objects, use the `FaceVertexAlphaData` property.

You can control how MATLAB interprets alpha data with the following properties:

- `FaceAlpha` and `EdgeAlpha` — Enable you to select flat or interpolated transparency rendering. If set to a single transparency value, MATLAB applies this value to all faces or edges and does not use the alpha data.
- `AlphaDataMapping` and `ALim` — Determine how MATLAB maps the alpha data to the alphamap. By default, MATLAB scales the alpha data to be within the range [0 1].
- `Alphamap` — Contains the actual transparency values to which the data is to be mapped.

Note that there are differences between the default values of equivalent color and alpha properties because, in contrast to color, transparency is not displayed by default. The following table highlights these differences.

Color Property	Default	Alpha Property	Default
<code>FaceColor</code>	Flat	<code>FaceAlpha</code>	1 (opaque)
<code>CData</code>	Equal to <code>ZData</code>	<code>AlphaData</code> and <code>FaceVertexAlphaData</code>	1 (scalar)

By default, objects have single-valued alpha data. Therefore you cannot specify flat or interp `FaceAlpha` or `EdgeAlpha` without first setting `AlphaData` to an array of the appropriate size.

The sections that follow illustrate how to use these properties to display object data as degrees of transparency.

Size of the Alpha Data Array

In order to use nonscalar alpha data, you need to specify the alpha data as an array equal in size to

- CData of images and surfaces
- The number of faces (flat) or the number of vertices (interpolated) defined in the FaceVertexAlphaData property of patches

Once you have specified an alpha data array of the proper size, you can select the face and edge rendering you want to use. Flat uses one transparency value per face, while interpolated performs bilinear interpolation of the values at each vertex.

Mapping Alpha Data to the Alphamap

You can control how MATLAB maps the alpha data to the alphamap using the AlphaDataMapping property. There are three possible mappings:

- none — Interpret the values in alpha data as transparency values (data values must be between 0 and 1, or will be clamped to 0 or 1). This is the default mapping.
- scaled — Transform the alpha data to span the portion of the alphamap indicated by the axes ALim property, linearly mapping data values to alpha values. This is the same way color data is mapped to the colormap.
- direct — Use the alpha data directly as indices into the figure alphamap.

By default, objects have scalar alpha data (AlphaData and FaceVertexAlphaData) set to the value 1.

Example — Mapping Data to Color or Transparency

This example displays a surface plot of a function of two variables. The color is mapped to the gradient of the z data.

```
[x,y] = meshgrid([-2:.2:2]);  
z = x.*exp(-x.^2-y.^2);  
surf(x,y,z,gradient(z)); axis tight
```

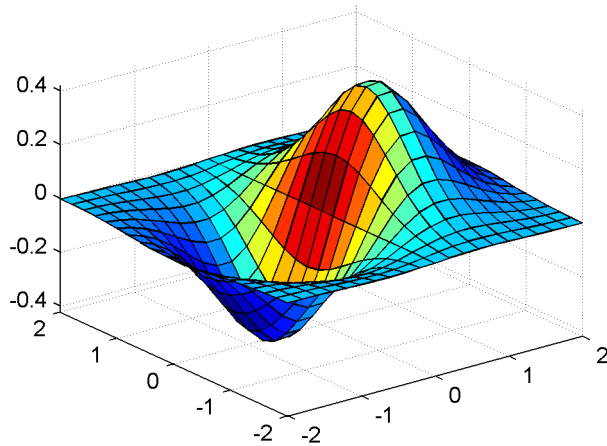

You can map transparency to the gradient of z in a similar way.

```
surf(x,y,z,'FaceAlpha','flat',...  
      'AlphaDataMapping','scaled',...  
      'AlphaData',gradient(z),...  
      'FaceColor','blue');  
axis tight
```

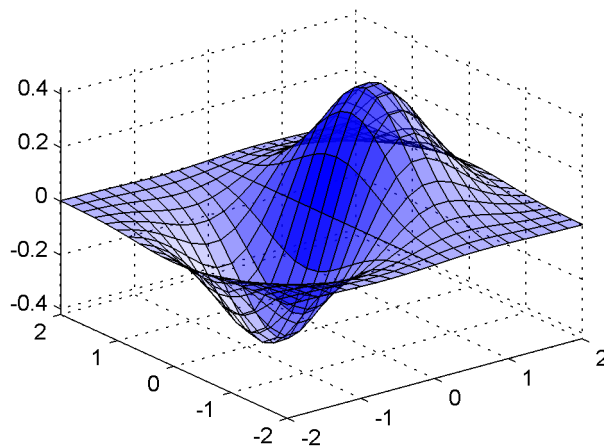

Selecting an Alphamap

An alphamap is simply an array of values ranging from 0 to 1. The size of the array can be either m-by-1 or 1-by-m.

The default alphamap contains 64 values ranging linearly from 0 to 1, as you can see in the following plot.

```
plot(get(gcf, 'Alphamap'))
```

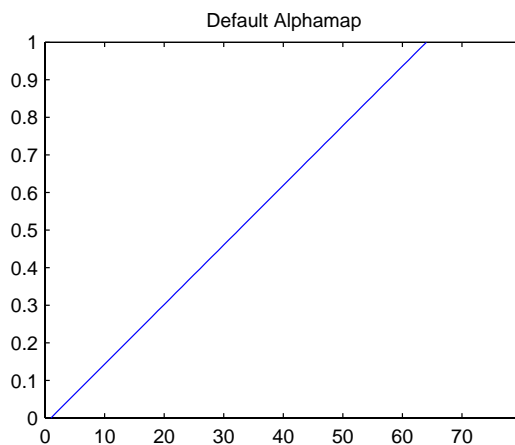

This alphamap displays the lowest alpha data values as completely transparent and the highest alpha data values as opaque.

The alphamap function creates some useful predefined alphamaps and also enables you to modify existing maps. For example,

```
plot(alphamap('vup'))
```

produces the following alphamap.

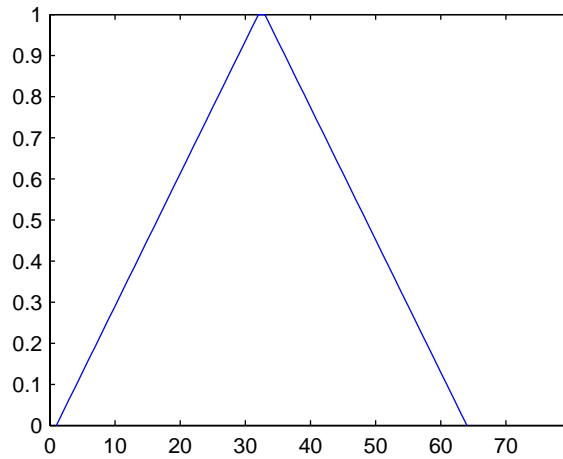

You can shift the values using the `increase` or `decrease` options. For example,

```
alphamap('increase', .4)
```

adds the value `.4` to all values in the current figure's alphamap. Replotting the `'vup'` alphamap illustrates the change. Note how the values are clamped to the range `[0 1]`.

```
plot(get(gcf, 'Alphamap'))
```

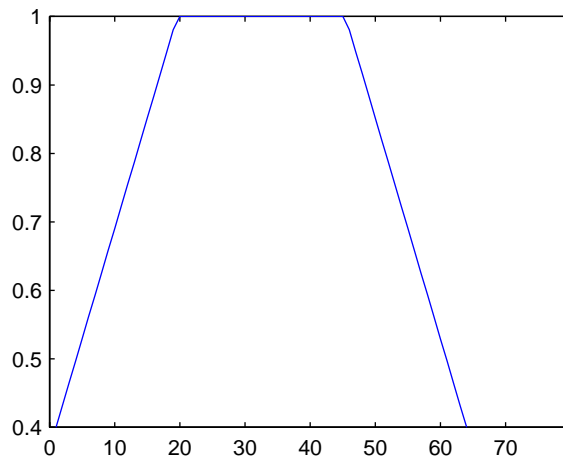

Example – Modifying the Alphamap

This example uses slice planes to examine volume data. The slice planes use the color data for alpha data and employ a rampdown alphamap (the values range from 1 to 0):

- 1 Create the volume data by evaluating a function of three variables.

```
[x,y,z] = meshgrid(-1.25:.1:-.25,-2:.2:2,-2:.1:2);
v = x.*exp(-x.^2-y.^2-z.^2);
```

- 2 Create the slice planes, set the alpha data equal to the color data, and specify interpolated FaceAlpha.

```
h = slice(x,y,z,v,[-1 -.75 -.5],[],[0]);
alpha('color')
set(h,'EdgeColor','none','FaceColor','interp',...
    'FaceAlpha','interp')
```

- 3 Install the rampdown alphamap and increase each value in the alphamap by .1 to achieve the desired degree of transparency. Specify the hsv colormap.

```
alphamap('rampdown')
alphamap('increase',.1)
```

```
colormap(hsv)
```

This alphamap causes the smallest values of the function (around zero) to be displayed with the least transparency and the greatest values to display with the most transparency. This enables you to see through the slice planes, while at the same time preserving the data around zero.

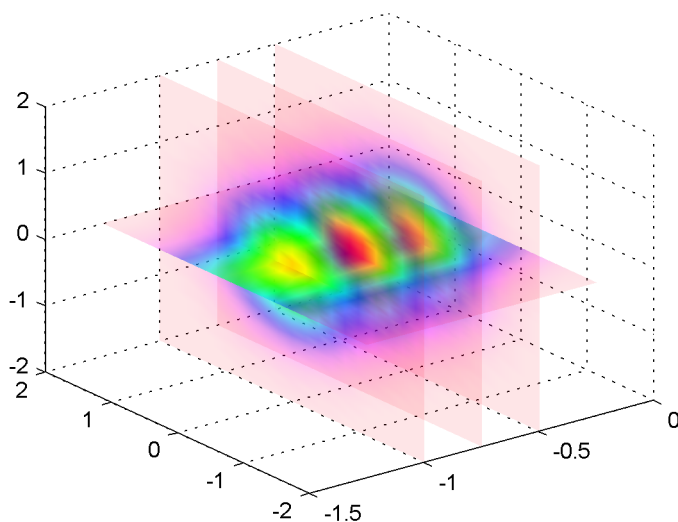

Creating 3-D Models with Patches

Introduction to Patch Objects (p. 15-2)	Overview of what a patch object is and how to define one
Multifaceted Patches (p. 15-6)	Shows how to define a 3-D patch object using both x -, y -, and z -coordinate and faces/vertices data, and illustrates flat and interpolated face coloring
Specifying Patch Coloring (p. 15-11)	How to specify patch coloring using various patch properties
Patch Edge Coloring (p. 15-13)	Details about how MATLAB determines patch edge coloring
Interpreting Indexed and Tricolor Data (p. 15-16)	Specifying color data that uses colormaps or defines explicit colors

Introduction to Patch Objects

A patch graphics object is composed of one or more polygons that may or may not be connected. Patches are useful for modeling real-world objects such as airplanes or automobiles, and for drawing 2- or 3-D polygons of arbitrary shape.

In contrast, surface objects are rectangular grids of quadrilaterals and are better suited for displaying planar topographies such as the values of mathematical functions of two variables, the contours of data in a rectangular plane, or parameterized surfaces such as spheres.

A number of MATLAB functions create patch objects — `fill`, `fill3`, `isosurface`, `isocaps`, some of the contour functions, and `patch`. This section concentrates on use of the `patch` function.

Defining Patches

You define a patch by specifying the coordinates of its vertices and some form of color data. Patches support a variety of coloring options that are useful for visualizing data superimposed on geometric shapes.

There are two ways to specify a patch:

- By specifying the coordinates of the vertices of each polygon, which MATLAB connects to form the patch
- By specifying the coordinates of each *unique* vertex and a matrix that specifies how to connect these vertices to form the faces

The second technique is preferred for multifaceted patches because it generally requires less data to define the patch; vertices shared by more than one face need be defined only once. This section provides examples of both techniques.

Behavior of the patch Function

There are two forms of the patch function — high-level syntax and low-level syntax. The behavior of the patch function differs somewhat depending on which syntax you use.

High-Level Syntax

When you use the high-level syntax, MATLAB automatically determines how to color each face based on the color data you specify. The high-level syntax enables you to omit the property names for the x -, y -, and z -coordinates and the color data, as long as you specify these arguments in the correct order.

```
patch(x-coordinates,y-coordinates,z-coordinates,colordata)
```

However, you must specify color data so MATLAB can determine what type of coloring to use. If you do not specify color data, MATLAB returns an error.

```
patch(sin(t),cos(t))
??? Error using ==> patch
Not enough input arguments.
```

Low-Level Syntax

The low-level syntax accepts only property name/property value pairs as arguments and does not automatically color the faces unless you also change the value of the `FaceColor` property. For example, the statement

```
patch('XData',sin(t),'YData',cos(t)) % Low-level syntax
```

draws a patch with white face color because the factory default value for the `FaceColor` property is the color white.

```
get(0,'FactoryPatchFaceColor')
ans =
     1     1     1
```

See the list of patch properties in the MATLAB Function Reference and the `get` command for information on how to obtain the factory and user default values for properties.

Interpreting the Color Argument

When you use the low-level syntax, MATLAB interprets the third (or fourth if there are z -coordinates) argument as color data. If you intend to define a patch with x -, y -, and z -coordinates, but leave out the color, MATLAB interprets the z -coordinates as color data, and then draws a 2-D patch. For example,

```
h = patch(sin(t),cos(t),1:length(t))
```

draws a patch with all vertices at $z = 0$, colored by interpolating the vertex colors (since there is one color for each vertex), whereas

```
h = patch(sin(t),cos(t),1:length(t),'y')
```

draws a patch with vertices at increasing values of z , colored yellow.

“Specifying Patch Coloring” on page 15-11 provides more information on options for coloring patches.

Creating a Single Polygon

A polygon is simply a patch with one face. To create a polygon, specify the coordinates of the vertices and color data with a statement of the form

```
patch(x-coordinates,y-coordinates,[z-coordinates],colordata)
```

For example, these statements display a 10-sided polygon with a yellow face enclosed by a black edge. The `axis equal` command produces a correctly proportioned polygon.

```
t = 0:pi/5:2*pi;  
patch(sin(t),cos(t),'y')  
axis equal
```

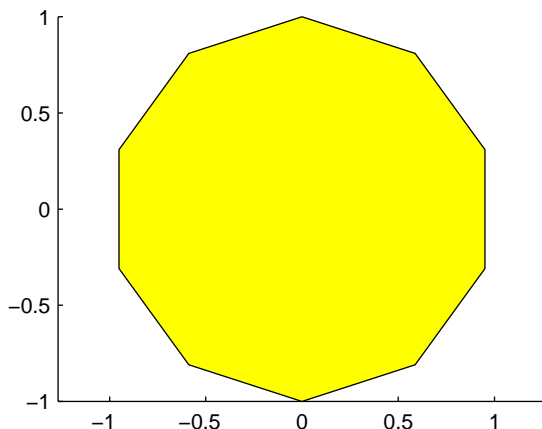

The first and last vertices need not coincide; MATLAB automatically closes each polygonal face of the patch. In fact, it is generally better to define each vertex only once, particularly if you are using interpolated face coloring.

Interpolated Face Colors

You can control many aspects of the patch coloring. For example, instead of specifying a single color, you can provide a range of numerical values that map the color at each vertex to a color in the figure colormap.

```
a = t(1:length(t)-1); %remove redundant vertex definition
patch(sin(a),cos(a),1:length(a),'FaceColor','interp')
colormap cool;
axis equal
```

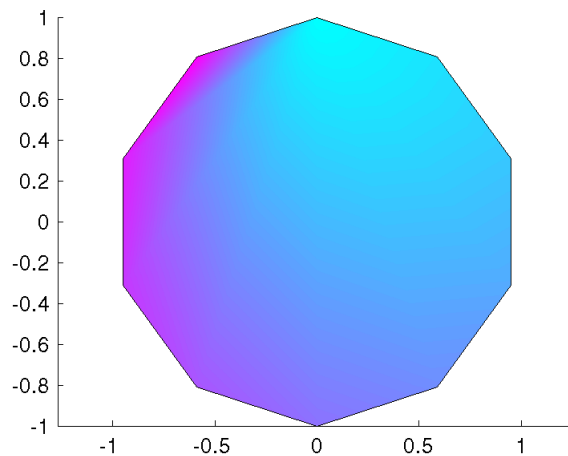

MATLAB now interpolates the colors across the face of the patch. You can color the edges of the patch the same way, by setting the edge colors to be interpolated. The command is

```
patch(sin(t),cos(t),1:length(t),'EdgeColor','interp')
```

“Specifying Patch Coloring” on page 15-11 provides more information on options for coloring patches.

Multifaceted Patches

If you specify the x -, y -, and z -coordinate arguments as vectors, MATLAB draws a single polygon by connecting the points. If the arguments are matrices, MATLAB draws one polygon per column, producing a single patch with multiple faces. These faces need not be connected and can be self-intersecting.

Alternatively, you can specify the coordinates of each unique vertex and the order in which to connect them to form the faces. The examples in this section illustrate both techniques.

Example – Defining a Cube

A cube is defined by eight vertices that form six sides. This illustration shows the coordinates of the vertices defining a cube in which the sides are one unit in length.

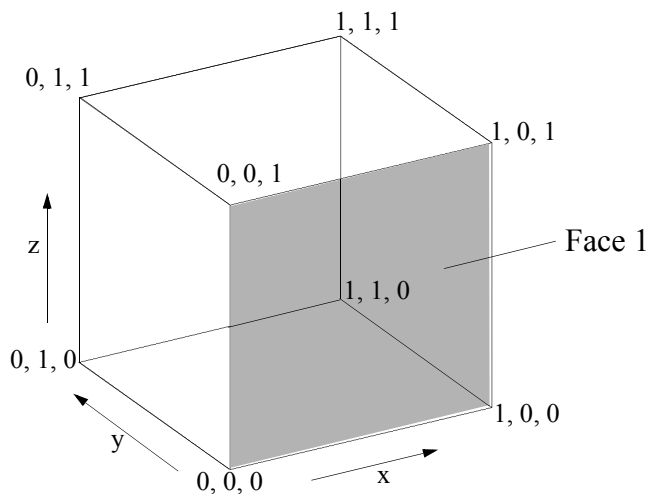

Specifying X, Y, and Z Coordinates

Each of the six faces has four vertices. Because you do not need to close each polygon (i.e., the first and last vertices do not need to be the same), you can define this cube using a 4-by-6 matrix for each of the x -, y -, and z -coordinates.

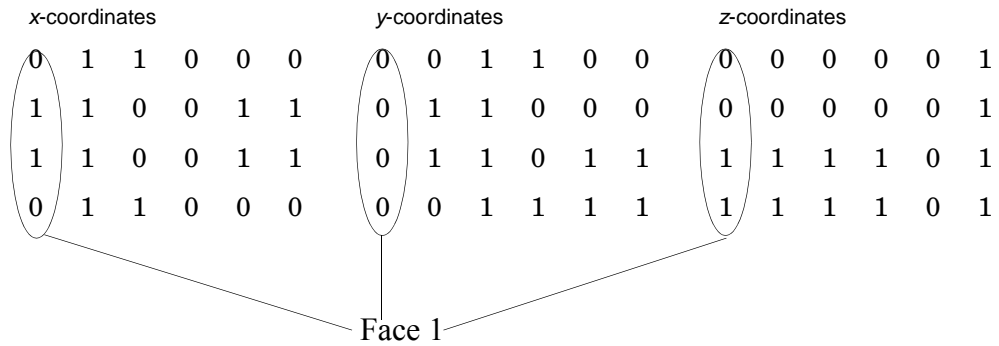

Each column of the matrices specifies a different face. Note that while there are only eight vertices, you must specify 24 vertices to define all six faces. Since each face shares vertices with four other faces, you can define the patch more efficiently by defining each vertex only once and then specifying the order in which to connect these vertices to form each face. The patch Vertices and Faces properties define patches in just this way.

Specifying Faces and Vertices

These matrices specify the cube using Vertices and Faces.

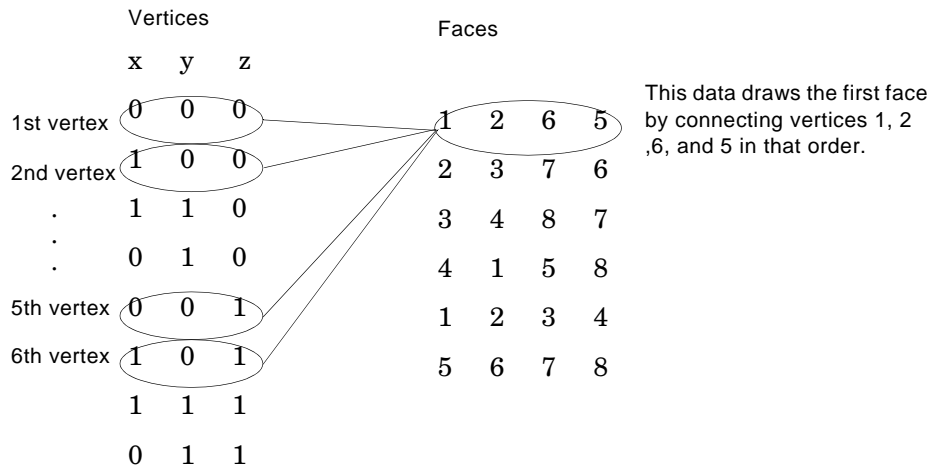

Using the vertices/faces technique can save a considerable amount of computer memory when patches contain a large number of faces. This technique requires the formal patch function syntax, which entails assigning values to the Vertices and Faces properties explicitly. For example,

```
patch('Vertices',vertex_matrix,'Faces',faces_matrix)
```

Because the high-level syntax does not automatically assign face or edge colors, you must set the appropriate properties to produce patches with colors other than the default white face color and black edge color.

Flat Face Color

Flat face color is the result of specifying one color per face. For example, using the vertices/faces technique and the FaceVertexCData property to define color, this statement specifies one color per face and sets the FaceColor property to flat.

```
patch('Vertices',vertex_matrix,'Faces',faces_matrix,...  
      'FaceVertexCData',hsv(6),'FaceColor','flat')
```

Because truecolor specified with the FaceVertexCData property has the same format as a MATLAB colormap (i.e., an n -by-3 array of RGB values), this example uses the hsv colormap to generate the six colors required for flat shading.

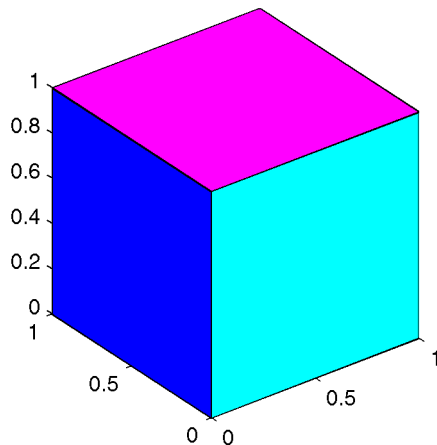

Interpolated Face Color

Interpolated face color means the vertex colors of each face define a transition of color from one vertex to the next. To interpolate the colors between vertices, you must specify a color for each vertex and set the `FaceColor` property to `interp`.

```
patch('Vertices', vertex_matrix, 'Faces', faces_matrix, ...
      'FaceVertexCData', hsv(8), 'FaceColor', 'interp')
```

Changing to the standard 3-D view and making the axis square,

```
view(3); axis square
```

produces a cube with each face colored by interpolating the vertex colors.

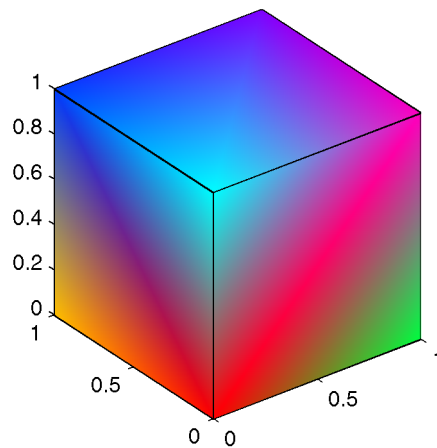

To specify the same coloring using the `x, y, z, c` technique, `c` must be an m -by- n -by-3 array, where the dimensions of `x`, `y`, and `z` are m -by- n .

This diagram shows the correspondence between the `FaceVertexCData` and `CData` properties.

FaceVertexCData =	CData(:,1) =	
1.00 0.00 0.00	1.00 1.00 0.50 0.00 1.00 0.00	
1.00 0.75 0.00	1.00 0.50 0.00 1.00 1.00 0.00	Red page
0.50 1.00 0.00	0.00 0.50 1.00 0.00 0.50 0.50	
0.00 1.00 0.25	0.00 0.00 0.50 1.00 0.00 1.00	
0.00 1.00 1.00	CData(:,2) =	
0.00 0.25 1.00	0.00 0.75 1.00 1.00 0.00 1.00	Green page
0.50 0.00 1.00	0.75 1.00 1.00 0.00 0.75 0.25	
1.00 0.00 0.75	0.25 0.00 0.00 1.00 1.00 0.00	
Red Green Blue	1.00 0.25 0.00 0.00 1.00 0.00	
	CData(:,3) =	Blue page
	0.00 0.00 0.00 0.25 0.00 1.00	
	0.00 0.00 0.25 0.00 0.00 1.00	
	1.00 1.00 0.75 1.00 0.00 1.00	
	1.00 1.00 1.00 0.75 0.25 0.75	

“Specifying Patch Coloring” on page 15-11 discusses coloring techniques in more detail.

Specifying Patch Coloring

Patch coloring is defined differently from surface object coloring in that patches do not automatically generate color data based on the value of the z -coordinate at each vertex. You must explicitly specify patch coloring, or MATLAB uses the default white face color and black edge color.

You can specify patch face coloring by defining

- A single color for all faces
- One color for each face, which is used for flat coloring
- One color for each vertex, which is used for interpolated coloring

Specify the face color using either the `CData` property, if you are using x -, y -, and z -coordinates, or the `FaceVertexCData` property, if you are specifying vertices and faces.

Patch Color Properties

This table summarizes the patch properties that control color (exclusive of those used when light sources are present).

Property	Purpose
<code>CData</code>	Specify single, per face, or per vertex colors in conjunction with x , y , and z data
<code>CDataMapping</code>	Specifies whether color data is scaled or used directly as indices into the figure colormap
<code>FaceVertexCData</code>	Specify single, per face, or per vertex colors in conjunction with faces and vertices data
<code>EdgeColor</code>	Specifies whether edges are invisible, a single color, a flat color determined by vertex colors, or interpolated colors determined by vertex colors

Property	Purpose
FaceColor	Specifies whether faces are invisible, a single color, a flat color determined by vertex colors, or interpolated colors determined by vertex colors
MarkerEdgeColor	Specifies the color of the marker, or the edge color for filled markers
MarkerFaceColor	Specifies the fill color for markers that are closed shapes

Patch Edge Coloring

Each patch face has a bounding edge, which you can color as

- A single color for all edges
- A flat color defined by the color of the vertex that precedes the edge
- Interpolated colors determined by the two vertices that bound the edge

Note that patch edge colors can be flat or interpolated only when you specify a color for each vertex. For flat edge coloring, MATLAB uses the color of the vertex preceding the edge to determine the color of the edge. The order in which you specify the vertices establishes which vertex colors a particular edge.

The following examples illustrate patch edge coloring:

- “Example — Specifying Flat Edge and Face Coloring” on page 15-13
- “Coloring Edges with Shared Vertices” on page 15-14

Example — Specifying Flat Edge and Face Coloring

These statements create a square patch.

```
v = [0 0 0;1 0 0;1 1 0;0 1 0];
f = [1 2 3 4];
fvc = [1 0 0;0 1 0;1 0 1;1 1 0];
patch('Vertices',v,'Faces',f,'FaceVertexCData',fvc,...
      'FaceColor','flat','EdgeColor','flat',...
      'Marker','o','MarkerFaceColor','flat')
```

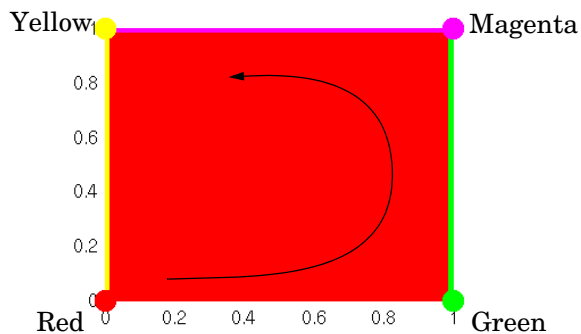

The Faces property value, [1 2 3 4], determines the order in which MATLAB connects the vertices. In this case, the order is red, green, magenta, and yellow. If you change this order, the results can be quite different. For example, specifying the Faces property as

```
f = [4 3 2 1];
```

changes the order to yellow, magenta, green, and red. Note that changing the order not only changes the color of the edges, but also the color of the face, which is the color of the first vertex specified.

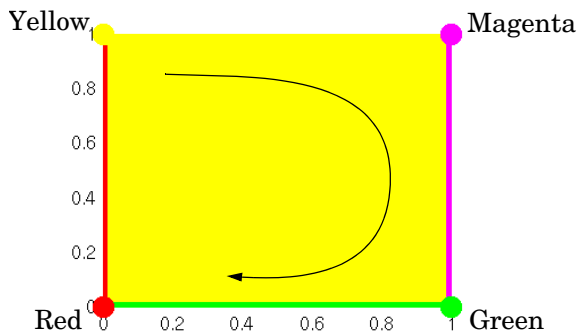

Coloring Edges with Shared Vertices

Each patch face is bound by edges, which are line segments that connect the vertices. When patches have multiple faces that share vertices, some of the

edges might overlap. In such cases, the edges of the most recently drawn face overlies previously drawn edges.

For example, this illustration shows a patch with four faces and flat colored edges (FaceColor set to none, EdgeColor set to flat).

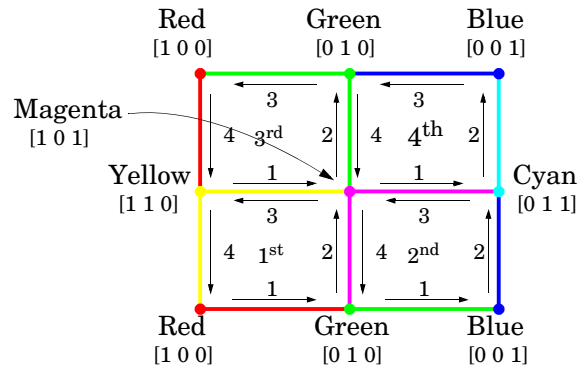

The arrows indicate the order in which each edge is drawn in the first, second, third, and fourth face. The color at each vertex determines the color of the edge that follows it. Notice how the second edge in the first face would be green except that the second face drew its fourth edge from the magenta vertex. You can see similar effects in all shared edges.

For EdgeColor set to interp, MATLAB interpolates colors between adjacent vertices. In this case, the order in which you specify the vertices does not affect the edge color.

Interpreting Indexed and Truecolor Data

MATLAB interprets the patch color data in one of two ways:

- Indexed color data — Numerical values that are mapped to colors defined in the figure colormap
- Truecolor data — RGB triples that define colors explicitly and do not make use of the figure colormap

The dimensions of the color data (CData or FaceVertexCData) determine how MATLAB interprets it. If you specify only one numeric value per patch, per face, or per vertex, then MATLAB interprets the data as indexed. If there are three numeric values per patch, face, or vertex, then MATLAB interprets the data as RGB values.

Indexed Color Data

MATLAB interprets indexed color data as either values to scale before mapping to the colormap, or directly as indices into the colormap. You control the interpretation by setting the CDataMapping property. The default is to scale the data.

Scaled Color

By default, MATLAB scales the color data so that the minimum value maps to the first color in the colormap, the maximum value maps to the last color in the colormap, and values in between are linearly transformed to span the colormap. This enables you to use colormaps of different sizes without changing your data and to use data in any range of values without changing the colormap.

For example, the following patch has eight triangular faces with a total of 24 (nonunique) vertices. The color data are integers that range from one to 24, but could be any values.

The variable `c` contains the color data. It is a 3-by-8 matrix, with each column specifying the colors for the three vertices of each face.

```
c =
     1     4     7    10    13    16    19    22
     2     5     8    11    14    17    20    23
     3     6     9    12    15    18    21    24
```

The color bar (colorbar) on the right side of the patch illustrates the colormap used and indicates with the vertical axis which color is mapped to the respective data value.

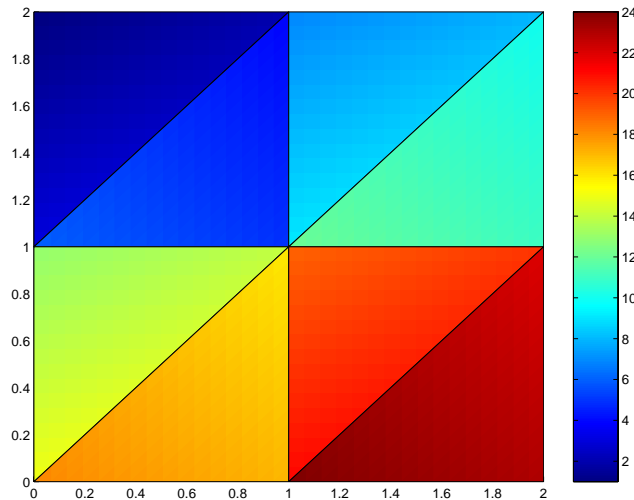

You can alter the mapping of color data to colormap entry using the `caxis` command. This command uses a two-element vector `[cmin cmax]` to specify what data values map to the beginning and end of the colormap, thereby shifting the color mapping.

By default, MATLAB sets `cmin` to the minimum value and `cmax` to the maximum value of the color data of all graphics objects within the axes. However, you can set these limits to span any range of values and thereby shift the color mapping. See “Calculating Color Limits” in “Axes Properties” in the Using MATLAB Graphics documentation for more information.

The color data does not need to be a sequential list of integers; it can be any matrix with dimensions matching the coordinate data. For example,

```
patch(x,y,z,rand(size(z)))
```

Direct Color

If you set the patch `CDataMapping` property to `direct`,

```
set(patch_handle, 'CDataMapping', 'direct')
```

MATLAB interprets each color data value as a direct index into the colormap. That is, a value of 1 maps to the first color, a value of 2 maps to the second color, and so on.

The patch from the previous example would then use only the first 24 colors in the colormap.

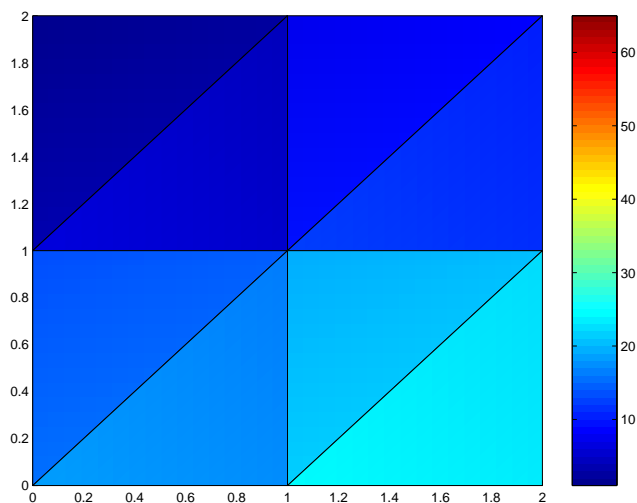

This example uses integer color data. However, if the values are not integers, MATLAB converts them according to these rules:

- If value is < 1 , it maps to the first color in the colormap.
- If value is not an integer, it is rounded to the nearest integer toward zero.
- If value $> \text{length}(\text{colormap})$, it maps to the last color in the colormap.

Unscaled color data is more commonly used for images where there is typically a colormap associated with a particular image.

Truecolor Patches

Truecolor is a means to specify a color explicitly with RGB values rather than pointing to an entry in the figure colormap. Truecolor generally provides a greater range of colors than can be defined in a colormap.

Using truecolor eliminates the mapping of data to colormap entries. On the other hand, you cannot change the coloring of the patch without redefining the color data (as opposed to just changing the colormap).

Interpolating in Indexed Color Versus Truecolor

When you specify interpolated face coloring, MATLAB determines the color of each face by interpolating the vertex colors. The method of interpolation depends on whether you specified truecolor data or indexed color data.

With truecolor data, MATLAB interpolates the numeric RGB values defined for the vertices. This generally produces a smooth variation of color across the face. In contrast, indexed color interpolation uses only colors that are defined in the colormap. With certain colormaps, the results can be quite different.

To illustrate this difference, these two patches are defined with the same vertex colors. Circular markers indicate the yellow, red, and blue vertex colors.

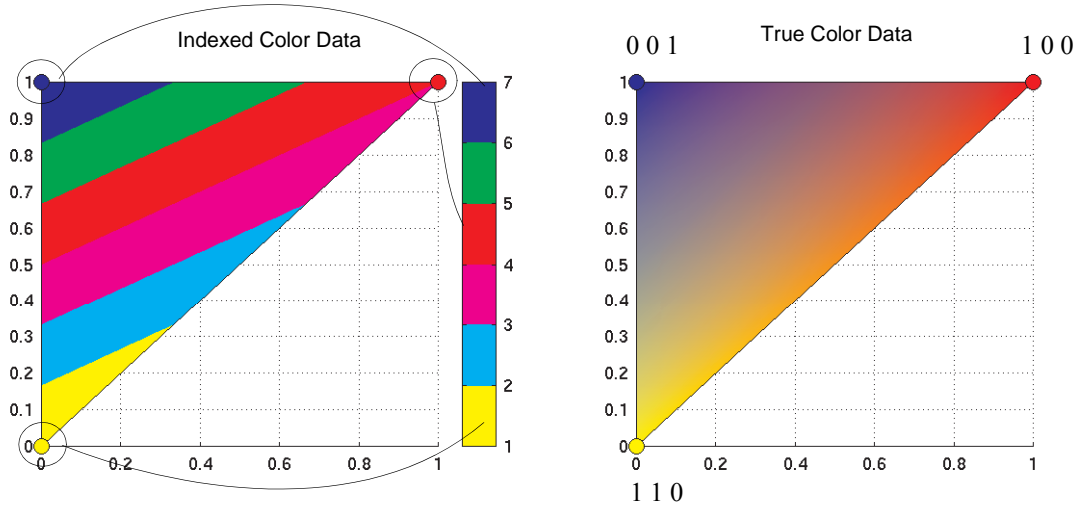

The patch on the left uses indexed colors obtained from the six-element colormap shown next to it. The color data maps the vertex colors to the colormap elements indicated in the picture. With this colormap, interpolating from the cyan vertex to the blue vertex can include only the colors green, red, yellow, and magenta, hence the banding.

Interpolation in RGB space makes no use of the colormap. It is simply the gradual transition from one numeric value to another. For example, interpolating from the cyan vertex to the blue vertex follows a progression similar to these values.

0 1 1, 0 0.9 1, 0 0.8 1, ... 0 0.2 1, 0 0.1 1, 0 0 1

In reality each pixel would be a different color so the incremental change would be much smaller than illustrated here.

Volume Visualization Techniques

Overview of Volume Visualization (p. 16-3)	Volume data visualization with MATLAB, including examples of available techniques
Volume Visualization Functions (p. 16-5)	Functions used for volume visualization
Visualizing Scalar Volume Data (p. 16-7)	Techniques available for visualizing scalar volume data
Visualizing MRI Data (p. 16-8)	Visualizing MRI data using 2- and 3-D contour slices, isosurfaces, isocaps, and lighting
Exploring Volumes with Slice Planes (p. 16-14)	Using slice planes to scan the interior of scalar volumes
Connecting Equal Values with Isosurfaces (p. 16-19)	Using isosurfaces to illustrate scalar fluid-flow data
Isocaps Add Context to Visualizations (p. 16-21)	Using isocaps to improve the shape definition of isosurface plots
Visualizing Vector Volume Data (p. 16-26)	Techniques for visualizing vector volume data, including scalar techniques, determining starting points for stream plots, and plotting subregions of volumes
Stream Line Plots of Vector Data (p. 16-32)	Using stream lines, slice planes, and contour lines in one graph
Displaying Curl with Stream Ribbons (p. 16-34)	Example using stream ribbon plots to display the curl of a vector field
Displaying Divergence with Stream Tubes (p. 16-36)	Example using stream tube plots to display the divergence of a vector field. Slice planes and contour lines enhance the visualization.

Creating Stream Particle Animations (p. 16-39)	Example using stream lines and stream particles to create an animation illustrating wind currents
Vector Field Displayed with Cone Plots (p. 16-42)	Example using cone plots, isosurfaces, lighting, and camera placement to visualize a vector field

Overview of Volume Visualization

Volume visualization is the creation of graphical representations of data sets that are defined on three-dimensional grids. Volume data sets are characterized by multidimensional arrays of scalar or vector data. These data are typically defined on lattice structures representing values sampled in 3-D space. There are two basic types of volume data:

- *Scalar volume data* contains single values for each point.
- *Vector volume data* contains two or three values for each point, defining the components of a vector.

Examples of Volume Data

An example of scalar volume data is that produced by the `flow` M-file. The flow data represents the speed profile of a submerged jet within an infinite tank.

Typing

```
[x,y,z,v] = flow;
```

produces four 3-D arrays. The `x`, `y`, and `z` arrays specify the coordinates of the scalar values in the array `v`.

The wind data set is an example of vector volume data that represents air currents over North America. You can load this data in the MATLAB workspace with the command

```
load wind
```

This data set comprises six 3-D arrays: `x`, `y`, and `z` are the coordinate data for the arrays `u`, `v`, and `w`, which are the vector components for each point in the volume.

Selecting Visualization Techniques

The techniques you select to visualize volume data depend on what type of data you have and what you want to learn. In general,

- Scalar data is best viewed with isosurfaces, slice planes, and contour slices.
- Vector data represents both a magnitude and direction at each point, which is best displayed by stream lines (particles, ribbons, and tubes), cone plots,

and arrow plots. Most visualizations, however, employ a combination of techniques to best reveal the content of the data.

The material in these sections describes how to apply a variety of techniques to typical volume data.

Steps to Create a Volume Visualization

Creating an effective visualization requires a number of steps to compose the final scene. These steps fall into four basic categories:

- 1** Determine the characteristics of your data. Graphing volume data usually requires knowledge of the range of both the coordinates and the data values.
- 2** Select an appropriate plotting routine. The information in this section helps you select the right methods.
- 3** Define the view. The information conveyed by a complex three-dimensional graph can be greatly enhanced through careful composition of the scene. Viewing techniques include adjusting camera position, specifying aspect ratio and project type, zooming in or out, and so on.
- 4** Add lighting and specify coloring. Lighting is an effective means to enhance the visibility of surface shape and to provide a three-dimensional perspective to volume graphs. Color can convey data values, both constant and varying.

Volume Visualization Functions

MATLAB provides functions that enable you to apply a variety of volume visualization techniques. The following tables group these functions into two categories based on the type of data (scalar or vector) that each is designed to work with. The reference page for each function provides examples of the intended use.

Functions for Scalar Data

Function	Purpose
<code>contourslice</code>	Draw contours in volume slice planes
<code>isocaps</code>	Compute isosurface end-cap geometry
<code>isocolors</code>	Compute the colors of isosurface vertices
<code>isonormals</code>	Compute normals of isosurface vertices
<code>isosurface</code>	Extract isosurface data from volume data
<code>patch</code>	Create a patch (multipolygon) graphics object
<code>reducepatch</code>	Reduce the number of patch faces
<code>reducevolume</code>	Reduce the number of elements in a volume data set
<code>shrinkfaces</code>	Reduce the size of each patch face
<code>slice</code>	Draw slice planes in volume
<code>smooth3</code>	Smooth 3-D data
<code>surf2patch</code>	Convert surface data to patch data
<code>subvolume</code>	Extract subset of volume data set

Functions for Vector Data

Function	Purpose
coneplot	Plot velocity vectors as cones in 3-D vector fields
curl	Compute the curl and angular velocity of a 3-D vector field
divergence	Compute the divergence of a 3-D vector field
interpstreamspeed	Interpolate streamline vertices from vector-field magnitudes
streamline	Draw stream lines from 2-D or 3-D vector data
streamparticles	Draw stream particles from vector volume data
streamribbon	Draw stream ribbons from vector volume data
streamslice	Draw well-spaced stream lines from vector volume data
streamtube	Draw stream tubes from vector volume data
stream2	Compute 2-D stream line data
stream3	Compute 3-D stream line data
volumebounds	Return coordinate and color limits for volume (scalar and vector)

Visualizing Scalar Volume Data

Typical scalar volume data is composed of a 3-D array of data and three coordinate arrays of the same dimensions. The coordinate arrays specify the x -, y -, and z -coordinates for each data point.

The units of the coordinates depend on the type of data. For example, flow data might have coordinate units of inches and data units of psi.

Techniques for Visualizing Scalar Data

MATLAB supports a number of functions that are useful for visualizing scalar data:

- Slice planes provide a way to explore the distribution of data values within the volume by mapping values to colors. You can orient slice planes at arbitrary angles, as well as use nonplanar slices. (For illustrations of how to use slice planes, see `slice`, a volume slicing example, and slice planes used to show context.) You can specify the data used to color isosurfaces, enabling you to display different information in color and surface shape (see `isocolors`).
- Contour slices are contour plots drawn at specific coordinates within the volume. Contour plots enable you to see where in a given plane the data values are equal. See `contourslice` for an example
- Isosurfaces are surfaces constructed by using points of equal value as the vertices of patch graphics objects.

Visualizing MRI Data

An example of scalar data includes Magnetic Resonance Imaging (MRI) data. This data typically contains a number of slice planes taken through a volume, such as the human body. MATLAB includes an MRI data set that contains 27 image slices of a human head. This section describes some useful techniques for visualizing MRI data.

Example – Ways to Display MRI Data

This example illustrates the following techniques applied to MRI data:

- A series of 2-D images representing slices through the head
- 2-D and 3-D contour slices taken at arbitrary locations within the data
- An isosurface with isocaps showing a cross section of the interior

Changing the Data Format

The MRI data, `D`, is stored as a 128-by-128-by-1-by-27 array. The third array dimension is used typically for the image color data. However, since these are indexed images (a colormap, `map`, is also loaded) there is no information in the third dimension, which you can remove using the `squeeze` command. The result is a 128-by-128-by-27 array.

The first step is to load the data and transform the data array from 4-D to 3-D.

```
load mri
D = squeeze(D);
```

Displaying Images of MRI Data

To display one of the MRI images, use the `image` command, indexing into the data array to obtain the eighth image. Then adjust axis scaling, and install the MRI colormap, which was loaded along with the data.

```
image_num = 8;
image(D(:, :, image_num))
axis image
colormap(map)
```

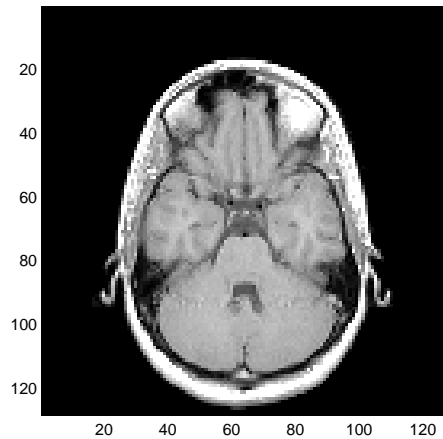
Save the x - and y -axis limits for use in the next part of the example.

```
x = xlim;  
y = ylim;
```

Displaying a 2-D Contour Slice

You can treat this MRI data as a volume because it is a collection of slices taken progressively through the 3-D object. Use `contourslice` to display a contour plot of a slice of the volume. To create a contour plot with the same orientation and size as the image created in the first part of this example, adjust the y -axis direction (axis), set the limits (`xlim`, `ylim`), and set the data aspect ratio (`daspect`).

```
contourslice(D,[],[],image_num)  
axis ij  
xlim(x)  
ylim(y)  
daspect([1,1,1])  
colormap('default')
```

This contour plot uses the figure colormap to map color to contour value.

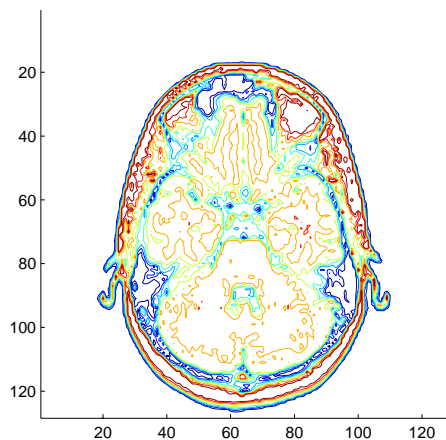

Displaying 3-D Contour Slices

Unlike images, which are 2-D objects, contour slices are 3-D objects that you can display in any orientation. For example, you can display four contour slices in a 3-D view. To improve the visibility of the contour line, increase the `LineWidth` to 2 points (one point equals 1/72 of an inch).

```
phandles = contourslice(D,[],[],[1,12,19,27],8);  
view(3); axis tight  
set(phandles,'LineWidth',2)
```

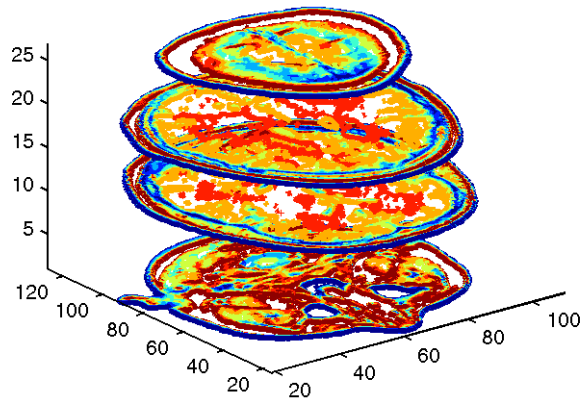

Displaying an Isosurface

You can use isosurfaces to display the overall structure of a volume. When combined with isocaps, this technique can reveal information about data on the interior of the isosurface.

First, smooth the data with `smooth3`; then use `isosurface` to calculate the isodata. Use `patch` to display this data as a graphics object.

```
Ds = smooth3(D);
hiso = patch(isosurface(Ds,5),...
    'FaceColor',[1,.75,.65],...
    'EdgeColor','none');
```

Adding an Isocap to Show a Cutaway Surface

Use `isocaps` to calculate the data for another patch that is displayed at the same isovalue (5) as the surface. Use the unsmoothed data (`D`) to show details of the interior. You can see this as the sliced-away top of the head.

```
hcap = patch(isocaps(D,5),...
    'FaceColor','interp',...
    'EdgeColor','none');
colormap(map)
```

Defining the View

Define the view and set the aspect ratio (view, axis, daspect).

```
view(45,30)
axis tight
daspect([1,1,.4])
```

Add Lighting

Add lighting and recalculate the surface normals based on the gradient of the volume data, which produces smoother lighting (camlight, lighting, isonormals). Increase the AmbientStrength property of the isocap to brighten the coloring without affecting the isosurface. Set the SpecularColorReflectance of the isosurface to make the color of the specular reflected light closer to the color of the isosurface; then set the SpecularExponent to reduce the size of the specular spot.

```
lightangle(45,30);
set(gcf,'Renderer','zbuffer'); lighting phong
isonormals(Ds,hiso)
set(hcap,'AmbientStrength',.6)
set(hiso,'SpecularColorReflectance',0,'SpecularExponent',50)
```

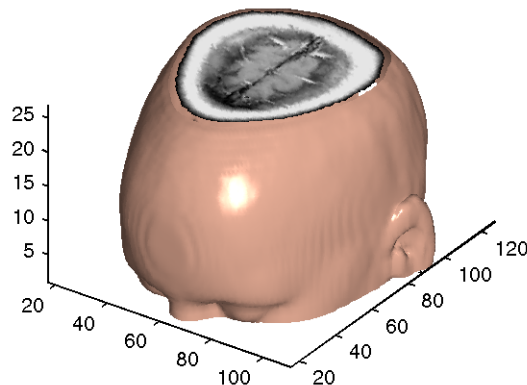

The isocap uses interpolated face coloring, which means the figure colormap determines the coloring of the patch. This example uses the colormap supplied with the data.

To display isocaps at other data values, try changing the isosurface value or use the `subvolume` command. See the `isocaps` and `subvolume` reference pages for examples.

Exploring Volumes with Slice Planes

A slice plane (which does not have to be planar) is a surface that takes on coloring based on the values of the volume data in the region where the slice is positioned. Slice planes are useful for probing volume data sets to discover where interesting regions exist, which you can then visualize with other types of graphs (see the `slice` example). Slice planes are also useful for adding a visual context to the bound of the volume when other graphing methods are also used (see `coneplot` and “Stream Line Plots of Vector Data” on page 16-32 for examples).

Use the `slice` function to create slice planes.

Example – Slicing Fluid Flow Data

This example slices through a volume generated by the `flow` M-file.

1. Investigate the Data

Generate the volume data with the command

```
[x,y,z,v] = flow;
```

Determine the range of the volume by finding the minimum and maximum of the coordinate data.

```
xmin = min(x(:));  
ymin = min(y(:));  
zmin = min(z(:));  
  
xmax = max(x(:));  
ymax = max(y(:));  
zmax = max(z(:));
```

2. Create a Slice Plane at an Angle to the X-Axes

To create a slice plane that does not lie in an axes plane, first define a surface and rotate it to the desired orientation. This example uses a surface that has the same x - and y - coordinates as the volume.

```
hslice = surf(linspace(xmin,xmax,100),...  
             linspace(ymin,ymax,100),...  
             zeros(100));
```

Rotate the surface by -45 degrees about the x -axis and save the surface XData, YData, and ZData to define the slice plane; then delete the surface.

```
rotate(hslice, [-1,0,0], -45)
xd = get(hslice, 'XData');
yd = get(hslice, 'YData');
zd = get(hslice, 'ZData');
delete(hslice)
```

3. Draw the Slice Planes

Draw the rotated slice plane, setting the FaceColor to interp so that it is colored by the figure colormap, and set the EdgeColor to none. Increase the DiffuseStrength to .8 to make this plane shine more brightly after adding a light source.

```
h = slice(x,y,z,v,xd,yd,zd);
set(h, 'FaceColor', 'interp', ...
    'EdgeColor', 'none', ...
    'DiffuseStrength', .8)
```

Set hold to on and add three more orthogonal slice planes at xmax, ymax, and zmin to provide a context for the first plane, which slices through the volume at an angle.

```
hold on
hx = slice(x,y,z,v,xmax,[],[]);
set(hx, 'FaceColor', 'interp', 'EdgeColor', 'none')

hy = slice(x,y,z,v,[],ymax,[]);
set(hy, 'FaceColor', 'interp', 'EdgeColor', 'none')

hz = slice(x,y,z,v,[],[],zmin);
set(hz, 'FaceColor', 'interp', 'EdgeColor', 'none')
```

4. Define the View

To display the volume in correct proportions, set the data aspect ratio to [1,1,1] (daspect). Adjust the axis to fit tightly around the volume (axis) and turn on the box to provide a sense of a 3-D object. The orientation of the axes can be selected initially using rotate3d to determine the best view.

Zooming in on the scene provides a larger view of the volume (camzoom). Selecting a projection type of perspective gives the rectangular solid more natural proportions than the default orthographic projection (camproj).

```
daspect([1,1,1])  
axis tight  
box on  
view(-38.5,16)  
camzoom(1.4)  
camproj perspective
```

5. Add Lighting and Specify Colors

Adding a light to the scene makes the boundaries between the four slice planes more obvious because each plane forms a different angle with the light source (lightangle). Selecting a colormap with only 24 colors (the default is 64) creates visible gradations that help indicate the variation within the volume.

```
lightangle(-45,45)  
colormap (jet(24))  
set(gcf, 'Renderer', 'zbuffer')
```

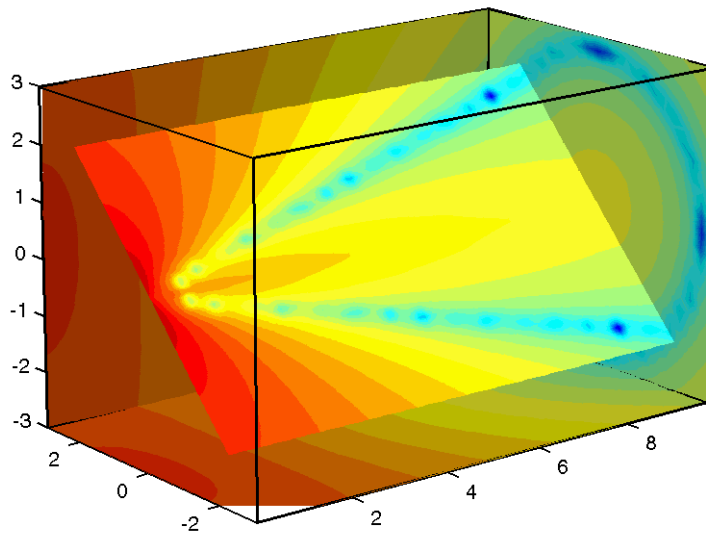

The “Modifying the Color Mapping” section shows how to modify how the data is mapped to color.

Modifying the Color Mapping

The current colormap determines the coloring of the slice planes. This enables you to change the slice plane coloring by

- Changing the colormap
- Changing the mapping of data value to color

Suppose, for example, you are interested in data values only between -5 and 2.5 and would like to use a colormap that mapped lower values to reds and higher values to blues (that is, the opposite of the default jet colormap).

Customizing the Colormap

The first step is to flip the colormap (`colormap, flipud`).

```
colormap (flipud(jet(24)))
```

Adjusting the Color Limits

Adjusting the color limits enables you to emphasize any particular data range of interest. Adjust the color limits to range from -5 to 2.4832 so that any value lower than the value -5 (the original data ranged from -11.5417 to 2.4832) is mapped into the same color. (See `caxis` and “Axis Color Limits – The CLim Property” in Axes Properties in the MATLAB documentation for an explanation of color mapping.)

```
caxis([-5,2.4832])
```

Adding a color bar provides a key for the data-to-color mapping.

```
colorbar('horiz')
```

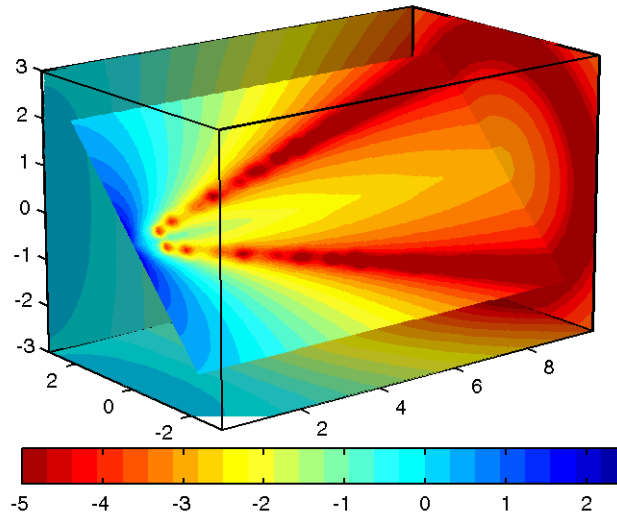

Connecting Equal Values with Isosurfaces

Isosurfaces are constructed by creating a surface within the volume that has the same value at each vertex. Isosurface plots are similar to contour plots in that they both indicate where values are equal.

Isosurfaces are useful to determine where in a volume a certain threshold value is reached or to observe the spatial distribution of data by selecting various isovalues at which to generate a plot. The isovalue must lie within the range of the volume data.

Create isosurfaces with the `isosurface` and `patch` commands.

Example – Isosurfaces in Fluid Flow Data

This example creates isosurfaces in a volume generated by the `flow` M-file. Generate the volume data with the command

```
[x,y,z,v] = flow;
```

To select the isovalue, determine the range of values in the volume data.

```
min(v(:))
ans =
    -11.5417
max(v(:))
ans =
     2.4832
```

Through exploration, you can select isovalues that reveal useful information about the data. Once selected, use the isovalue to create the isosurface:

- Use `isosurface` to generate data that you can pass directly to `patch`.
- Recalculate the surface normals from the gradient of the volume data to produce better lighting characteristics (`isonormals`).
- Set the patch `FaceColor` to red and the `EdgeColor` to none to produce a smoothly lit surface.
- Adjust the view and add lighting (`daspect`, `view`, `camlight`, `lighting`).

```
hpatch = patch(isosurface(x,y,z,v,0));
isonormals(x,y,z,v,hpatch)
set(hpatch,'FaceColor','red','EdgeColor','none')
```

```
daspect([1,4,4])  
view([-65,20])  
axis tight  
camlight left;  
set(gcf,'Renderer','zbuffer'); lighting phong
```

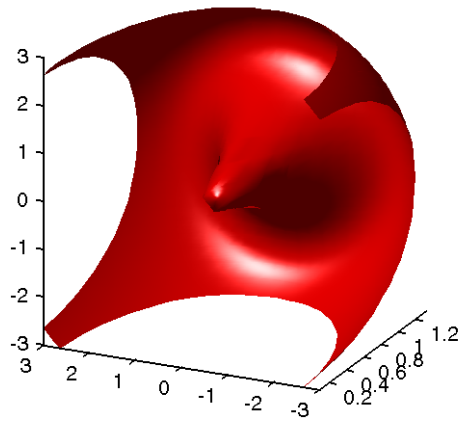

Isocaps Add Context to Visualizations

Isocaps are planes that are fitted to the limits of an isosurface to provide a visual context for the isosurface. Isocaps show a cross-sectional view of the interior of the isosurface for which the isocap provides an *end cap*.

The following two pictures illustrate the use of isocaps. The first is an isosurface without isocaps.

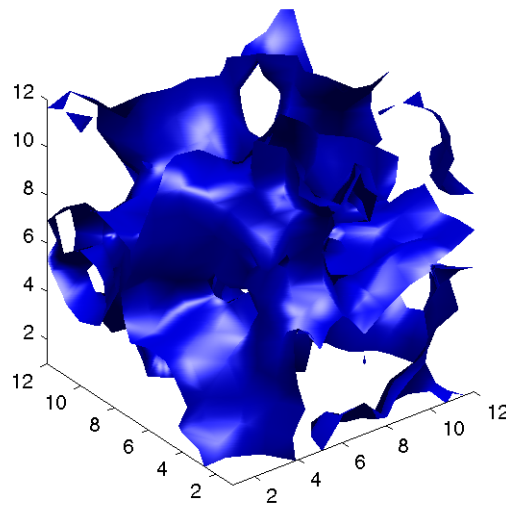

The second picture shows the effect of adding isocaps to the same isosurface.

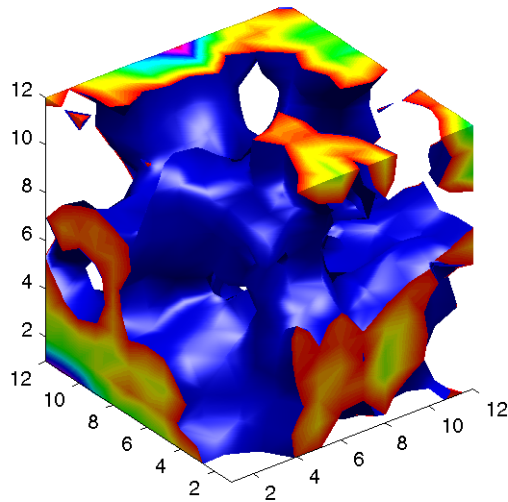

Other Isocap Applications

Some additional applications of isocaps are shown in the following examples.

- Isocaps show the interior of a cut-away volume.
- Isocaps cap the end of a volume that would otherwise appear empty.
- Isocaps enhance the visibility of the isosurface limits.

Defining Isocaps

Isocaps, like isosurfaces, are created as patch graphics objects. Use the `isocaps` command to generate the data to pass to `patch`. For example,

```
patch(isocaps(voldata,isoval),...  
      'FaceColor','interp',...  
      'EdgeColor','none')
```

creates isocaps for the scalar volume data `voldata` at the value `isoval`. You should create the isosurface using the same volume data and isovalue to ensure that the edges of the isocaps *fit* the isosurface.

Setting the patch `FaceColor` property to `interp` results in a coloring that maps the data values spanned by the isocap to `colormap` entries. You can also set other patch properties to control the effects of lighting and coloring on the isocaps.

Example – Adding Isocaps to an Isosurface

This example illustrates how to set coloring and lighting characteristics when working with isocaps. There are five basic steps:

- Generate and process your volume data.
- Create the isosurface and isocaps and set patch properties to control the coloring and lighting.
- Create the isocaps and set properties.
- Specify the view.
- Add lights to the scene.

1. Prepare the Data

This example uses a 3-D array of random (`rand`) data to define the volume data. The data is then smoothed (`smooth3`).

```
data = rand(12,12,12);  
data = smooth3(data, 'box', 5);
```

2. Create the Isosurface and Set Properties

Use `isosurface` and `patch` to create the isosurface and set coloring and lighting properties. Reduce the `AmbientStrength`, `SpecularStrength`, and `DiffuseStrength` of the reflected light to compensate for the brightness of the two light sources used to provide more uniform lighting.

Recalculate the vertex normals of the isosurface to produce smoother lighting (`isonormals`).

```
isoval = .5;  
h = patch(isosurface(data, isoval), ...  
    'FaceColor', 'blue', ...  
    'EdgeColor', 'none', ...  
    'AmbientStrength', .2, ...  
    'SpecularStrength', .7, ...  
    'DiffuseStrength', .4);
```

```
isonormals(data,h)
```

3. Create the Isocaps and Set Properties

Define the isocaps using the same data and isovalue as the isosurface. Specify interpolated coloring and select a colormap that provides better contrasting colors with the blue isosurface than those in the default colormap (colormap).

```
patch(isocaps(data,isoval),...  
      'FaceColor','interp',...  
      'EdgeColor','none')  
colormap hsv
```

4. Define the View

Set the data aspect ratio to [1,1,1] so that the display is in correct proportions (daspect). Eliminate white space within the axes and set the view to 3-D (axis tight, view).

```
daspect([1,1,1])  
axis tight  
view(3)
```

5. Add Lighting

To add fairly uniform lighting, but still take advantage of the ability of light sources to make visible subtle variations in shape, this example uses two lights, one to the left and one to the right of the camera (camlight). Use Phong lighting to produce the smoothest variation of color (lighting). Phong lighting requires the zbuffer renderer.

```
camlight right  
camlight left  
set(gcf,'Renderer','zbuffer');  
lighting phong
```

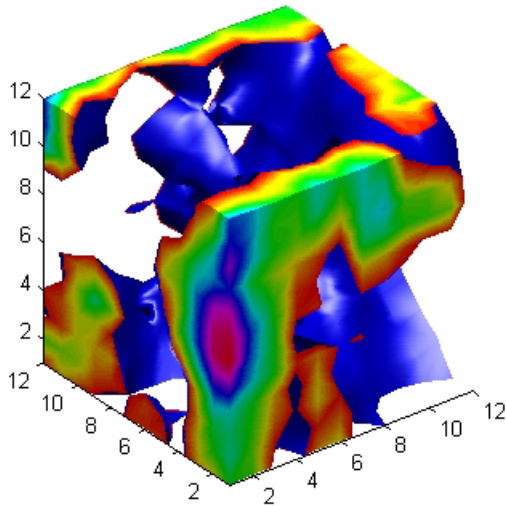
Visualizing Vector Volume Data

Vector volume data contains more information than scalar data because each coordinate point in the data set has three values associated with it. These values define a vector that represents both a magnitude and a direction. The velocity of fluid flow is an example of vector data.

MATLAB supports a number of techniques that are useful for visualizing vector data:

- Stream lines trace the path that a massless particle immersed in the vector field would follow.
- Stream particles are markers that trace stream lines and are useful for creating stream line animations.
- Stream ribbons are similar to stream lines, except that the width of the ribbons enables them to indicate twist. Stream ribbons are useful to indicate curl angular velocity.
- Stream tubes are similar to stream lines, but you can also control the width of the tube. Stream tubes are useful for displaying the divergence of a vector field.
- Cone plots represent the magnitude and direction of the data at each point by displaying a conical arrowhead or an arrow.

It is typically the case that these functions best elucidate the data when used in conjunction with other visualization techniques, such as contours, slice planes, and isosurfaces. The examples in this section illustrate some of these techniques.

Using Scalar Techniques with Vector Data

Visualization techniques such as contour slices, slice planes, and isosurfaces require scalar volume data. You can use these techniques with vector data by taking the magnitude of the vectors. For example, the wind data set returns three coordinate arrays and three vector component arrays, u , v , w . In this case, the magnitude of the velocity vectors equals the wind speed at each corresponding coordinate point in the volume.

```
wind_speed = sqrt(u.^2 + v.^2 + w.^2);
```

The array `wind_speed` contains scalar values for the volume data. The usefulness of the information produced by this approach, however, depends on what physical phenomenon is represented by the magnitude of your vector data.

Specifying Starting Points for Stream Plots

Stream plots (stream lines, ribbons, tubes, and cones or arrows) illustrate the flow of a 3-D vector field. The MATLAB stream plotting routines (`streamline`, `streamribbon`, `streamtube`, `coneplot`, `stream2`, `stream3`) all require you to specify the point at which you want to begin each stream trace.

Determining the Starting Points

Generally, knowledge of your data's characteristics helps you select the starting points. Information such as the primary direction of flow and the range of the data coordinates helps you decide where to evaluate the data.

The `streamslice` function is useful for exploring your data. For example, these statements draw a slice through the vector field at a `z` value midway in the range.

```
load wind
zmax = max(z(:)); zmin = min(z(:));
streamslice(x,y,z,u,v,w,[],[],(zmax-zmin)/2)
```

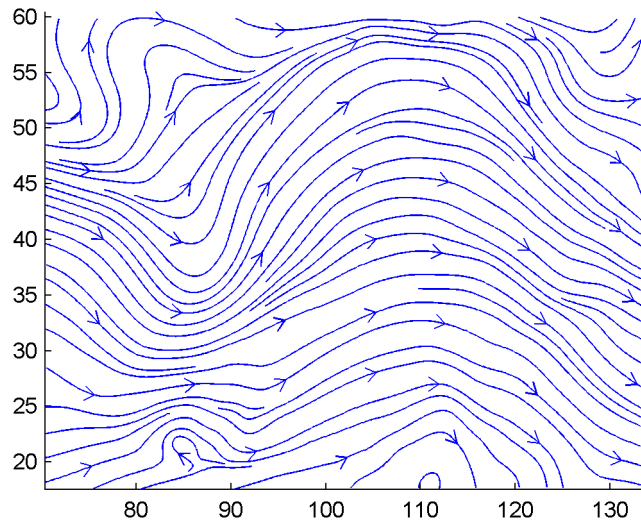

This stream slice plot indicates that the flow is in the positive x direction and also enables you to select starting points in both x and y . You could create similar plots that slice the volume in the x - z plane or the y - z plane to gain further insight into your data's range and orientation.

Specifying Arrays of Starting-Point Coordinates

To specify the starting point for one stream line, you need the x -, y -, and z -coordinates of the point. The `meshgrid` command provides a convenient way to create arrays of starting points. For example, you could select the following starting points from the wind data displayed in the previous stream slice.

```
[sx,sy,sz] = meshgrid(80,20:10:50,0:5:15);
```

This statement defines the starting points as all lying on $x = 80$, y ranging from 20 to 50, and z ranging from 0 to 15. You can use `plot3` to display the locations.

```
plot3(sx(:),sy(:),sz(:),'*r');
axis(volumebounds(x,y,z,u,v,w))
grid; box; daspect([2 2 1])
```

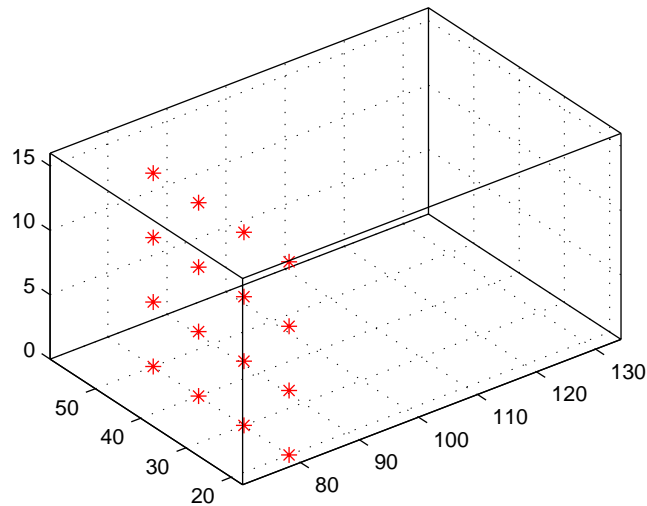

You do not need to use 3-D arrays, such as those returned by `meshgrid`, but the size of each array must be the same, and `meshgrid` provides a convenient way to generate arrays when you do not have an equal number of unique values in each coordinate. You can also define starting-point arrays as column vectors. For example, `meshgrid` returns 3-D arrays.

```
[sx,sy,sz] = meshgrid(80,20:10:50,0:5:15);
whos
Name      Size      Bytes  Class
sx        4x1x4      128   double array
sy        4x1x4      128   double array
sz        4x1x4      128   double array
```

In addition, you could use 16-by-1 column vectors with the corresponding elements of the three arrays composing the coordinates of each starting point. (This is the equivalent of indexing the values returned by `meshgrid` as `sx(:)`, `sy(:)`, and `sz(:)`.)

For example, adding the stream lines produces

```
streamline(x,y,z,u,v,w,sx(:),sy(:),sz(:))
```

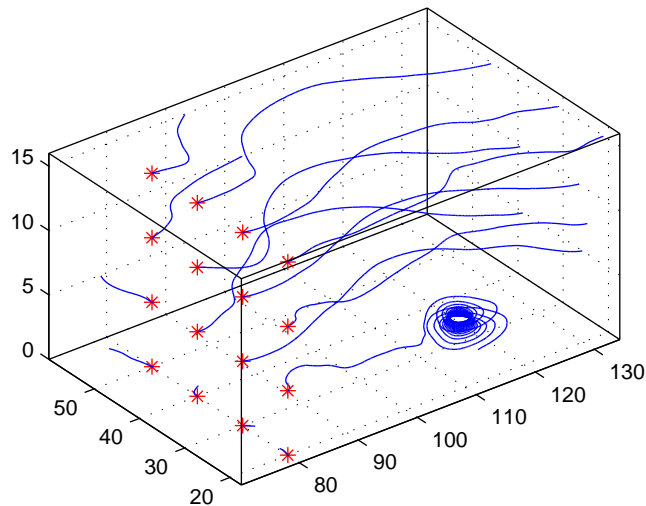

Accessing Subregions of Volume Data

The `subvolume` function provides a simple way to access subregions of a volume data set. `subvolume` enables you to select regions of interest based on limits rather than using the colon operator to index into the 3-D arrays that define volumes. Consider the following two approaches to creating the data for a subvolume — indexing with the colon operator and using `subvolume`.

Indexing with the Colon Operator

When you index the arrays, you work with values that specify the elements in each dimension of the array.

```
load wind
xsub = x(1:10,20:30,1:7);
ysub = y(1:10,20:30,1:7);
zsub = z(1:10,20:30,1:7);
usub = u(1:10,20:30,1:7);
vsub = v(1:10,20:30,1:7);
wsub = w(1:10,20:30,1:7);
```

Using the subvolume Function

`subvolume` enables you to use coordinate values that you can read from the axes. For example,

```
lims = [100.64 116.67 17.25 28.75 -0.02 6.86];  
[xsub,ysub,zsub,usub,vsub,wsub] = subvolume(x,y,z,u,v,w,lims);
```

You can then use the subvolume data as inputs to any function requiring vector volume data.

Stream Line Plots of Vector Data

MATLAB includes a vector data set called `wind` that represents air currents over North America. This example uses a combination of techniques:

- Stream lines to trace the wind velocity
- Slice planes to show cross-sectional views of the data
- Contours on the slice planes to improve the visibility of slice-plane coloring

1. Determine the Range of the Coordinates

Load the data and determine minimum and maximum values to locate the slice planes and contour plots (`load`, `min`, `max`).

```
load wind
xmin = min(x(:));
xmax = max(x(:));
ymax = max(y(:));
zmin = min(z(:));
```

2. Add Slice Planes for Visual Context

Calculate the magnitude of the vector field (which represents wind speed) to generate scalar data for the `slice` command. Create slice planes along the x -axis at `xmin`, 100, and `xmax`, along the y -axis at `ymax`, and along the z -axis at `zmin`. Specify interpolated face coloring so the slice coloring indicates wind speed, and do not draw edges (`sqrt`, `slice`, `FaceColor`, `EdgeColor`).

```
wind_speed = sqrt(u.^2 + v.^2 + w.^2);
hsurfaces = slice(x,y,z,wind_speed,[xmin,100,xmax],ymax,zmin);
set(hsurfaces,'FaceColor','interp','EdgeColor','none')
```

3. Add Contour Lines to the Slice Planes

Draw light gray contour lines on the slice planes to help quantify the color mapping (`contourslice`, `EdgeColor`, `LineWidth`).

```
hcont = ...
contourslice(x,y,z,wind_speed,[xmin,100,xmax],ymax,zmin);
set(hcont,'EdgeColor',[.7,.7,.7],'LineWidth',.5)
```

4. Define the Starting Points for the Stream Lines

In this example, all stream lines start at an x -axis value of 80 and span the range 20 to 50 in the y direction and 0 to 15 in the z direction. Save the handles of the stream lines and set the line width and color (meshgrid, streamline, LineWidth, Color).

```
[sx, sy, sz] = meshgrid(80, 20:10:50, 0:5:15);  
hlines = streamline(x, y, z, u, v, w, sx, sy, sz);  
set(hlines, 'LineWidth', 2, 'Color', 'r')
```

5. Define the View

Set up the view, expanding the z -axis to make it easier to read the graph (view, daspect, axis).

```
view(3)  
daspect([2, 2, 1])  
axis tight
```

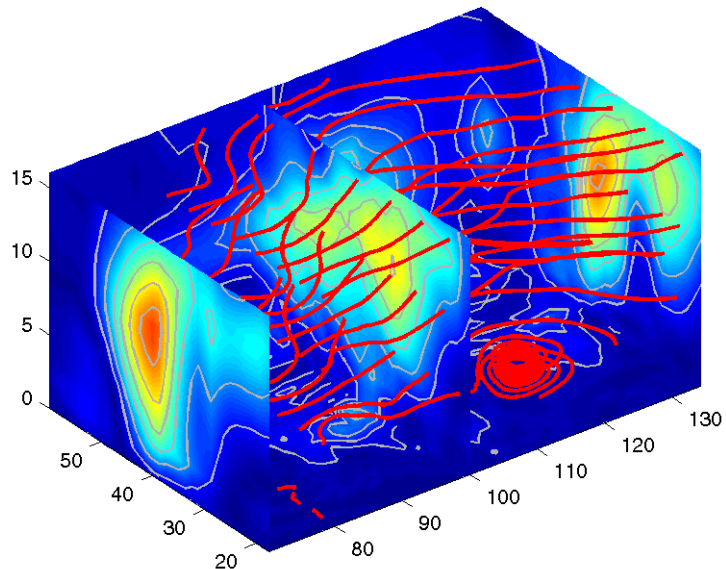

See coneplot for an example of the same data plotted with cones.

Displaying Curl with Stream Ribbons

Stream ribbons illustrate direction of flow, similar to stream lines, but can also show rotation about the flow axis by twisting the ribbon-shaped flow line. The `streamribbon` function enables you to specify a twist angle (in radians) for each vertex in the stream ribbons.

When used in conjunction with the `curl` function, `streamribbon` is useful for displaying the curl angular velocity of a vector field. The following example illustrates this technique:

1. Select a Subset of Data to Plot

Load and select a region of interest in the wind data set using `subvolume`. Plotting the full data set first can help you select a region of interest.

```
load wind
lims = [100.64 116.67 17.25 28.75 -0.02 6.86];
[x,y,z,u,v,w] = subvolume(x,y,z,u,v,w,lims);
```

2. Calculate Curl Angular Velocity and Wind Speed

Calculate the curl angular velocity and the wind speed.

```
cav = curl(x,y,z,u,v,w);
wind_speed = sqrt(u.^2 + v.^2 + w.^2);
```

3. Create the Stream Ribbons

- Use `meshgrid` to create arrays of starting points for the stream ribbons. See "Starting Points for Stream Plots" in this chapter for information on specifying the arrays of starting points.
- `stream3` calculates the stream line vertices with a step size of `.5`.
- `streamribbon` scales the width of the ribbon by a factor of 2 to enhance the visibility of the twisting (which indicates curl angular velocity).
- `streamribbon` returns the handles of the surface objects it creates, which are then used to set the color to red (`FaceColor`), the color of the surface edges to light gray (`EdgeColor`), and slightly increase the brightness of the ambient light reflected when lighting is applied (`AmbientStrength`).

```
[sx sy sz] = meshgrid(110,20:5:30,1:5);
verts = stream3(x,y,z,u,v,w,sx,sy,sz,.5);
```

```
h = streamribbon(verts,x,y,z,cav,wind_speed,2);  
set(h,'FaceColor','r',...  
    'EdgeColor',[.7 .7 .7],...  
    'AmbientStrength',.6)
```

4. Define the View and Add Lighting

- The `volumebounds` command provides a convenient way to set axis and color limits.
- Add a grid and set the view for 3-D (`streamribbon` does not change the current view).
- `camlight` creates a light positioned to the right of the viewpoint and `lighting` sets the lighting method to Phong (which requires the Z-buffer renderer).

```
axis(volumebounds(x,y,z,wind_speed))  
grid on  
view(3)  
camlight right;  
set(gcf,'Renderer','zbuffer'); lighting phong
```

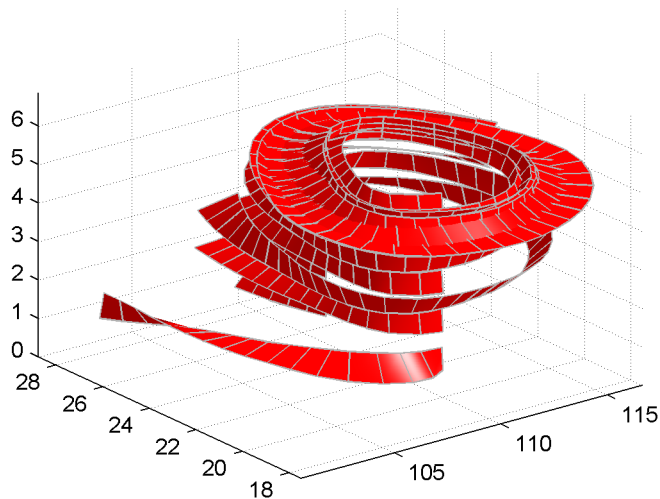

Displaying Divergence with Stream Tubes

Stream tubes are similar to stream lines, except the tubes have width, providing another dimension that you can use to represent information.

By default, MATLAB indicates the divergence of the vector field by the width of the tube. You can also define widths for each tube vertex and thereby map other data to width.

This example uses the following techniques:

- Stream tubes to indicate flow direction and divergence of the vector field in the wind data set
- Slice planes colored to indicate the speed of the wind currents overlaid with contour line to enhance visibility

Inputs include the coordinates of the volume, vector field components, and starting locations for the stream tubes.

1. Load Data and Calculate Required Values

The first step is to load the data and calculate values needed to make the plots. These values include

- The location of the slice planes (maximum x, minimum y, and a value for the altitude)
- The minimum x value for the start of the stream tubes
- The speed of the wind (magnitude of the vector field)

```
load wind
xmin = min(x(:));
xmax = max(x(:));
ymin = min(y(:));
alt = 7.356; % z-value for slice and streamtube plane
wind_speed = sqrt(u.^2 + v.^2 + w.^2);
```

2. Draw the Slice Planes

Draw the slice planes (`slice`) and set surface properties to create a smoothly colored slice. Use 16 colors from the `hsv colormap`.

```
hslice = slice(x,y,z,wind_speed,xmax,ymin,alt);
set(hslice,'FaceColor','interp','EdgeColor','none')
```

```
colormap hsv(16)
```

3. Add Contour Lines to Slice Planes

Add contour lines (`contourslice`) to the slice planes. Adjust the contour interval so the lines match the color boundaries in the slice planes:

- Call `caxis` to get the current color limits.
- Set the interpolation method used by `contourslice` to `linear` to match the default used by `slice`.

```
color_lim = caxis;
cont_intervals = linspace(color_lim(1),color_lim(2),17);
hcont = contourslice(x,y,z,wind_speed,xmax,ymin,...
    alt,cont_intervals,'linear');
set(hcont,'EdgeColor',[.4 .4 .4],'LineWidth',1)
```

4. Create the Stream Tubes

Use `meshgrid` to create arrays for the starting points for the stream tubes, which begin at the minimum `x` value, range from 20 to 50 in `y`, and lie in a single plane in `z` (corresponding to one of the slice planes).

The stream tubes (`streamtube`) are drawn at the specified locations and scaled to be 1.25 times the default width to emphasize the variation in divergence (width). The second element in the vector `[1.25 30]` specifies the number of points along the circumference of the tube (the default is 20). You might want to increase this value as the tube size increases, to maintain a smooth-looking tube.

Set the data aspect ratio (`daspect`) before calling `streamtube`.

Stream tubes are surface objects, therefore you can control their appearance by setting surface properties. This example sets surface properties to give a brightly lit, red surface.

```
[sx,sy,sz] = meshgrid(xmin,20:3:50,alt);
daspect([1,1,1]) % set DAR before calling streamtube
htubes = streamtube(x,y,z,u,v,w,sx,sy,sz,[1.25 30]);
set(htubes,'EdgeColor','none','FaceColor','r',...
    'AmbientStrength',.5)
```

5. Define the View

The final step is to define the view and add lighting (view, axis, volumebounds, Projection, camlight).

```
view(-100,30)
axis(volumebounds(x,y,z,wind_speed))
set(gca,'Projection','perspective')
camlight left
```

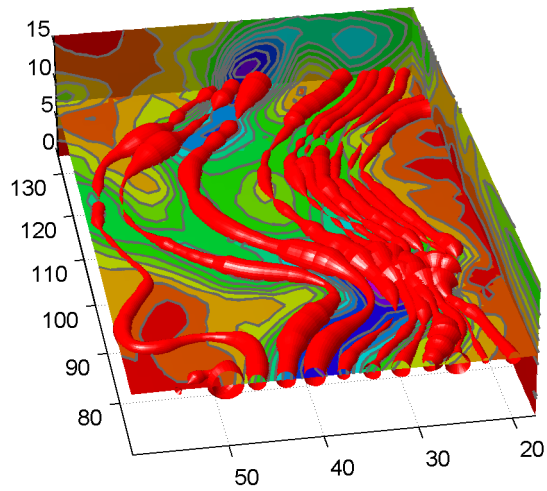

Creating Stream Particle Animations

A stream particle animation is useful for visualizing the flow direction and speed of a vector field. The “particles” (represented by any of the line markers) trace the flow along a particular stream line. The speed of each particle in the animation is proportional to the magnitude of the vector field at any given point along the stream line:

1. Specify the Starting Points of the Data Range to Plot

This example determines the region of the volume to plot by specifying the appropriate starting points. In this case, the stream plots begin at $x = 100$, y spans 20 to 50 and in the $z = 5$ plane. Note that this is not the full volume bounds.

```
load wind
[sx sy sz] = meshgrid(100,20:2:50,5);
```

2. Create Stream Lines to Indicate the Particle Paths

This example uses stream lines (`stream3`, `streamline`) to trace the path of the animated particles. This adds a visual context for the animation. Another possibility is to set the `EraseMode` property of the stream particle to `none`, which would be useful for a single trace through the volume.

```
verts = stream3(x,y,z,u,v,w,sx,sy,sz);
sl = streamline(verts);
```

3. Define the View

While all the stream lines start in the $z = 5$ plane, the values of some spiral down to lower values. The following settings provide a clear view of the animation:

- The viewpoint (`view`) selected shows both the plane containing most stream lines and the spiral.
- Selecting a data aspect ratio (`daspect`) of `[2 2 0.125]` provides greater resolution in the z direction to make the stream particles more easily visible in the spiral.
- Set the axes limits to match the data limits (`axis`) and draw the axis box (`box`).

```
view(-10.5,18)
daspect([2 2 0.125])
axis tight; box on
```

4. Calculate the Stream Particle Vertices

The first step is to determine the vertices along the stream line where a particle should be drawn. The `interpstreamspeed` function returns this data based on the stream line vertices and the speed of the vector data. This example scales the velocities by 0.05 to increase the number of interpolated vertices.

Setting the axes `DrawMode` property to `fast` enables the animation to run faster.

The `streamparticles` function sets the following properties:

- `Animate` to 10 to run the animation 10 times
- `ParticleAlignment` to `on` to start all particle traces together
- `MarkerEdgeColor` to `none` to draw only the face of the circular marker. Animations usually run faster when marker edges are not drawn.
- `MarkerFaceColor` to `red`
- `Marker` to `o`, which draws a circular marker. You can use other line markers as well.

```
iverts = interpstreamspeed(x,y,z,u,v,w,verts,0.05);
set(gca,'drawmode','fast');
streamparticles(iverts,15,...
    'Animate',10,...
    'ParticleAlignment','on',...
    'MarkerEdgeColor','none',...
    'MarkerFaceColor','red',...
    'Marker','o');
```

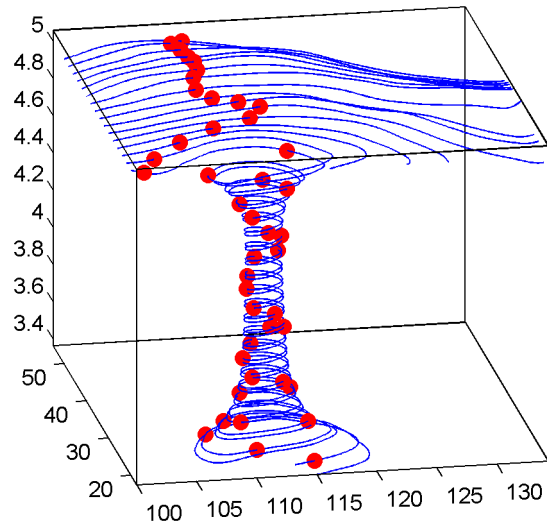
Vector Field Displayed with Cone Plots

This example plots the velocity vector cones for the wind data. The graph produced employs a number of visualization techniques:

- An isosurface is used to provide visual context for the cone plots and to provide means to select a specific data value for a set of cones.
- Lighting enables the shape of the isosurface to be clearly visible.
- The use of perspective projection, camera positioning, and view angle adjustments composes the final view.

1. Create an Isosurface

Displaying an isosurface within the rectangular space of the data provides a visual context for the cone plot. Creating the isosurface requires a number of steps:

- Calculate the magnitude of the vector field, which represents the speed of the wind.
- Use `isosurface` and `patch` to draw an isosurface illustrating where in the rectangular space the wind speed is equal to a particular value. Regions inside the isosurface have higher wind speeds, regions outside the isosurface have lower wind speeds.
- Use `isonormals` to compute vertex normals of the isosurface from the volume data rather than calculate the normals from the triangles used to render the isosurface. These normals generally produce more accurate results.
- Set visual properties of the isosurface, making it red and without drawing edges (`FaceColor`, `EdgeColor`).

```
load wind
wind_speed = sqrt(u.^2 + v.^2 + w.^2);
hiso = patch(isosurface(x,y,z,wind_speed,40));
isonormals(x,y,z,wind_speed,hiso)
set(hiso,'FaceColor','red','EdgeColor','none');
```

2. Add Isocaps to the Isosurface

Isocaps are similar to slice planes in that they show a cross section of the volume. They are designed to be the end caps of isosurfaces. Using interpolated face color on an isocap causes a mapping of data value to color in the current

`colormap`. To create isocaps for the isosurface, define them at the same isovalue (`isocaps`, `patch`, `colormap`).

```
hcap = patch(isocaps(x,y,z,wind_speed,40),...
            'FaceColor','interp',...
            'EdgeColor','none');
colormap hsv
```

3. Create First Set of Cones

- Use `daspect` to set the data aspect ratio of the axes before calling `coneplot` so MATLAB can determine the proper size of the cones.
- Determine the points at which to place cones by calculating another isosurface that has a smaller isovalue (so the cones are displayed outside the first isosurface) and use `reducepatch` to reduce the number of faces and vertices (so there are not too many cones on the graph).
- Draw the cones and set the face color to blue and the edge color to none.

```
daspect([1,1,1]);
[f verts] = reducepatch(isosurface(x,y,z,wind_speed,30),0.07);
h1 = coneplot(x,y,z,u,v,w,verts(:,1),verts(:,2),verts(:,3),3);
set(h1,'FaceColor','blue','EdgeColor','none');
```

4. Create Second Set of Cones

- Create a second set of points at values that span the data range (`linspace`, `meshgrid`).
- Draw a second set of cones and set the face color to green and the edge color to none.

```
xrange = linspace(min(x(:)),max(x(:)),10);
yrange = linspace(min(y(:)),max(y(:)),10);
zrange = 3:4:15;
[cx,cy,cz] = meshgrid(xrange,yrange,zrange);
h2 = coneplot(x,y,z,u,v,w,cx,cy,cz,2);
set(h2,'FaceColor','green','EdgeColor','none');
```

5. Define the View

- Use the axis command to set the axis limits equal to the minimum and maximum values of the data and enclose the graph in a box to improve the sense of a volume (box).
- Set the projection type to perspective to create a more natural view of the volume. Set the viewpoint and zoom in to make the scene larger (camproj, camzoom, view).

```
axis tight
box on
camproj perspective
camzoom(1.25)
view(65,45)
```

6. Add Lighting

Add a light source and use Phong lighting for the smoothest lighting of the isosurface (Phong lighting requires the Z-buffer renderer). Increase the strength of the background lighting on the isocaps to make them brighter (camlight, lighting, AmbientStrength).

```
camlight(-45,45)
set(gcf,'Renderer','zbuffer');
lighting phong
set(hcap,'AmbientStrength',.6)
```

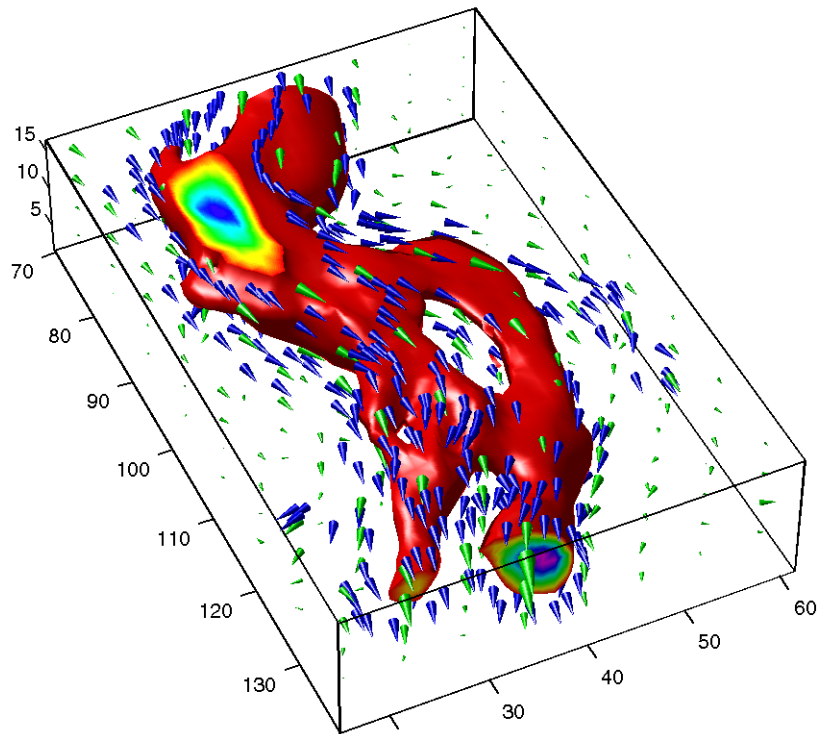

A

- ActivePositionProperty property 10-7
- adding data to axes 1-13
- alpha values 14-3
- ambient light 13-12
- AmbientLightColor property 13-8
 - illustration 13-12
- AmbientStrength property 13-8
 - illustration 13-12
- animation 5-50
 - erase modes for 5-52
 - movies 5-50
- annotating graphs 3-1, 3-2
 - adding a title 3-26
 - adding labels 3-29
 - adding plots of data statistics 2-20
 - adding text 3-35
- area 5-2, 5-11
- area graphs 5-2, 5-11
- arrays, storing images 6-4
- arrows
 - adding to a graph 3-49
- aspect ratio 12-39–12-53
 - for realistic objects 12-52
 - properties that affect 12-44
 - specifying 12-48
- aspect ratio of figures 7-41, 7-43
 - See also* printing
- axes
 - adding labels 3-29
 - adding text 3-36
 - aspect ratio 12-39, 12-44
 - 2-D 4-24
 - 3-D 12-39
 - properties that affect 12-44
 - specifying 12-48
- automatic modes 10-25
- axis control 10-16
- axis direction 10-19
- camera properties 12-28
- CLim property 10-30
- color limits 10-30
- ColorOrder property 10-36
- colors 10-28
- controlling the shape of 12-48
- default aspect ratio 12-45
- individual axis control 10-16
- labeling 3-32
- labels
 - font properties 10-4
 - using TeX characters 3-42
- limits 12-39
 - example 12-51
- locking position 1-39
- making grids coincident 10-23
- multiaxis 10-22
- multiple 4-27, 10-13
- NextPlot property 8-61
- overlapping 10-13
- plot box 12-8
- position rectangle 12-29
- positioning 10-5–10-15
- preparing to accept graphics 8-60
- properties
 - for labeling 10-3
- protecting from output 8-66
- scaling 12-39
 - independent 10-14
- setting
 - limits 10-17
 - line styles used for plotting 10-37
- setting limits 4-20
- standard plotting behavior 8-65

- stretch-to-fill 12-39
- target for graphics 4-29
- tick marks 4-22
 - locating 10-18
- units 10-6
- unlocking position 1-39
- with two *x*- and *y*-axes 10-22
- axis 6-2, 12-39
 - auto 12-39
 - equal 4-25, 12-40
 - ij 12-40
 - illustrated examples, 2-D 4-25
 - illustrated examples, 3-D 12-41
 - image 6-22, 12-40
 - manual 12-40
 - normal 12-40
 - square 4-25, 12-40
 - tight 4-26, 12-40
 - vis3d 12-40
 - xy 12-40
- axis labels, rotating 3-31
- azimuth of viewpoint 12-4
 - default 2-D 12-5
 - default 3-D 12-5
 - limitations 12-7

B

- BackFaceLighting property 13-9
 - illustration 13-14
- background color, of text 3-46
- backing store 9-10
- bar 5-2, 5-3
- bar graphs 5-2–5-11
 - 3-D 5-3
 - grouped
 - 2-D 5-2

- 3-D 5-4
- horizontal 5-6
- labeling 5-4, 5-7
- overlaid with plots 5-9
- stacked 5-5
- bar3 5-2, 5-3
- bar3h 5-2
- barh 5-2
- binary images 6-8
- bins, specifying for histogram 5-20
- BMP 6-2
- brighten 11-19
- buttons on toolbar 3-49

C

- callbacks
 - function handles used for 8-86
 - using function handles for 8-86
- camdolly 12-19
- camera position, moving 12-29
- camera properties 12-28
 - illustration showing 12-8
- camera toolbar 12-9
- CameraPosition property 12-28
 - and perspective 12-29
 - fly-by 12-29
- CameraPositionMode property 12-28
- CameraTarget property 12-28
- CameraTargetMode property 12-28
- CameraUpVector property 12-28, 12-32
 - example 12-33
- CameraUpVectorMode property 12-28
- CameraViewAngle property 12-28
 - and perspective 12-31
 - zooming with 12-31
- CameraViewAngleMode property 12-28, 12-31

- camlookat 12-19
- camorbit 12-19
- campan 12-19
- campos 12-19
- camproj 12-19
- camroll 12-19
- camtarget 12-19
- camup 12-19
- camva 12-19
- camzoom 12-19
- CData property
 - patches 15-11
- CData property
 - images 6-25
- CDataMapping property
 - patches 15-11
- CDataMapping property 11-17
 - images 6-25
- cla 8-61
- clabel 5-37, 5-39
- clf 8-61
- close 8-68
- close request function
 - default 8-68
- closereq.m 8-68
- CloseRequestFcn property 8-68
 - default value 8-68
 - errors in 8-69
 - overriding 8-69
- closing figures 8-68
- closing MATLAB, errors occurring when 8-69
- color limits, calculating 10-32
- colorbar 11-15
- colordef 4-30
- colormap 11-14
- colormaps
 - altering 11-19
 - brightening 11-19
 - brightness component of TV signal 11-20
 - displaying 11-15
 - for surfaces 11-14
 - functions that create 11-15
 - range of RGB values in 11-14
 - simulating multiple 10-31
- ColorOrder 10-35
- colors
 - changing color scheme 10-28
 - colormaps 11-14
 - controlled by axes 10-28
 - indexed 11-13, 11-14
 - direct 11-16
 - scaled 11-16
 - interpreted by surfaces 11-13
 - mapping to data 10-30
 - NTSC encoding of 11-20
 - of patches 15-11
 - of surface plots 11-13
 - scaling algorithm 11-17
 - specifying figure colors 4-29
 - specifying for surface plot, example 11-17
 - truecolor 11-13
 - specifying 11-20
 - typical RGB values 11-14
 - used for plotting 10-35
- compass 5-31
- compass plots 5-31
- complex numbers, plotting 4-16
 - with feather 5-33
- cone plots 16-42
- containers for graphics objects 8-75
- contour 5-37
- contour plots 5-37
 - algorithm 5-42
 - filled 5-40

- in polar coordinates 5-44
- labeling 5-39
- specifying contour levels 5-41, 5-43
- contour3 5-37
- contourc 5-37, 5-42
- contourf 5-37, 5-40
- converting the data class of an indexed image
 - 6-11
- coordinate system and viewpoint 12-4
- copying
 - figures 1-43
 - options 1-43
- copying graphics objects 8-56
- current
 - axes 8-50
 - figure 8-50
 - object 8-50
- current figure 8-6
- cursors
 - See* pointers
- curve fitting graph data 2-18

D

- data cursor 2-3
- data statistics
 - formatting plots of 2-23
 - plotting 2-20, 2-24
- Data Statistics tool
 - example 2-21
 - interface 2-22
 - saving to workspace 2-26
- data tips 2-7
 - See also* data cursor
- data types
 - 8-bit integers 6-4
 - double-precision 6-4

- DataAspectRatio property 12-44
 - example 12-48
- DataAspectRatio property
 - images 6-23
- DataAspectRatioMode property 12-44
- default
 - aspect ratio 12-45
 - of figure windows 7-41
 - azimuth
 - 2-D 12-5
 - 3-D 12-5
 - CameraPosition 12-29
 - CameraTarget 12-29
 - CameraUpVector 12-29
 - CameraViewAngle 12-29
 - CloseRequestFcn 8-68
 - elevation
 - 2-D 12-5
 - 3-D 12-5
 - factory 8-42
 - figure color scheme 4-29
 - Projection 12-29
 - property values 8-43–8-49
 - removing 8-45
 - search path, diagram 8-43
 - setting to factory defaults 8-46
 - view 12-29
- default line styles, setting and removing 4-12
- de12 11-17
- deleting graphics objects 8-58
- deselecting objects 1-39
- diffuse reflection 13-11
- DiffuseStrength property 13-8
 - illustration 13-11
- direct color mapping 11-16
- direction cosines 12-32
- discrete data graphs 5-22–5-30

- stairstep plots 5-29
- stem plots 5-22
- double
 - converting image data to double 6-31
 - converting to uint16 6-12
 - converting to uint8 6-12
 - converting to uint8 or uint16 6-11
- double buffering 9-10

- E**
- edge effects and lighting 13-15
- EdgeColor property 13-9
- EdgeLighting property 13-9
- edges of patches 15-14
- editing plots 1-36
 - interactively 1-37
- efficient programming 8-71, 8-72
- elevation of viewpoint 12-4
 - default 2-D 12-5
 - default 3-D 12-5
 - limitations 12-7
- ending plot edit mode 1-38
- erase modes 5-52
 - and printing 5-54
 - background 5-54
 - images 6-28
 - none 5-52
 - xor 5-55
- errors closing MATLAB 8-69
- examples
 - 3-D graph 11-2
 - animation 5-52
 - area graphs 5-11
 - axis 12-41
 - bar graphs 5-3
 - changing CameraPosition 12-30
 - contour plots 5-37
 - copying graphics objects 8-56
 - custom pointers 9-15
 - DataAspectRatio property 12-48
 - del2 11-17
 - direction and velocity graphs 5-31
 - direction cosines 12-32
 - discrete data graphs 5-22
 - displaying real objects 12-52
 - double axis graphs 10-22
 - finding object handles 8-52
 - histograms 5-17
 - hold 8-66
 - line 8-63
 - linspace 11-9
 - meshgrid 11-3, 11-9
 - movies 5-51
 - multiline text 3-45
 - newplot 8-63
 - object creation functions 8-12
 - of lighting 13-2
 - overlapping axes 10-13
 - parametric surfaces 11-11
 - pie charts 5-14
 - plot 4-3
 - complex data 4-16
 - plot3 11-3
 - PlotBoxAspectRatio property 12-49
 - plotting line styles 10-37
 - ScreenSize property 9-7
 - setting default property values 8-46
 - simulating multiple colormaps 10-31
 - specifying figure position 9-7
 - specifying truecolor
 - surfaces 11-20
 - stretch-to-fill 12-48
 - subplot 4-27

- text 3-36
- texture mapping 11-23
- unevenly sampled data 11-8
- view 12-31
- exporting
 - Enhanced Metafiles 7-71
- exporting figures 1-43
 - Adobe Illustrator 7-73
 - EPS files 7-71
 - formats
 - choosing a format 7-64
 - MATLAB and GhostScript 7-66
 - vector or bitmap 7-66
 - JPEG files 7-73
 - LaTeX
 - importing example 7-26
 - lighting 7-69
 - publication quality 7-72
 - TIFF files 7-73
 - transparency 7-69
- extent of computer screen 9-6

- F**
- FaceColor property 13-9
- FaceLighting property 13-8
- Faces property 15-7
- FaceVertexCData property 15-9, 15-11
- factory defaults 8-42
- feather 5-31, 5-32
- feather plots 5-32
- figure
 - colormap 9-9
 - palette 1-7
 - toolbar 1-2
- figure files 1-42, 1-43
- figures
 - CloseRequestFcn 8-68
 - closing 8-68
 - copying 1-43
 - defining custom pointers 9-14
 - defining pointers 9-13
 - defining the color of 4-29
 - exporting 1-43
 - for plotting 4-27
 - introduction to 9-2
 - NextPlot property 8-61
 - opening 1-43
 - positioning 9-5
 - positioning example 9-7
 - preparing to accept graphics 8-60
 - printing
 - default figure size for printing 7-41
 - protecting from output 8-66
 - rendering properties 9-10
 - saving 1-42
 - specifying pointers 9-13
 - standard plotting behavior 8-65
 - units 9-6
 - visible property 8-68
 - with multiple axes 4-27
- files
 - exporting 1-43
 - figure .fig 1-42
 - formats for figures 1-43
 - opening 1-43
 - printing 1-44
 - saving 1-42
- fill, properties changed by 8-72
- fill3, properties changed by 8-72
- findobj 8-52
- fly-by effect 12-29
- fonts
 - axis labels 10-4

- formats for figures 1-43
 - function handles
 - Handle Graphics callbacks 8-86
 - functions
 - convenience forms 8-15
 - high-level vs. low-level 8-14
- G**
- gca 8-51
 - handle visibility 8-67
 - gcf 8-51
 - handle visibility 8-67
 - gco 8-51
 - get 8-38
 - getframe 5-50
 - GIF graphic file format 7-73
 - ginput 5-48
 - Gouraud lighting algorithm 13-10
 - gradient 5-35
 - graphical input 5-48
 - graphics file formats
 - list of formats supported by MATLAB 6-2
 - graphics images
 - 16-bit
 - intensity 6-12
 - 8-bit
 - intensity 6-12
 - RGB 6-12
 - converting from one format to another 6-31
 - converting to RGB 6-31
 - reading from file 6-17
 - writing to file 6-18
 - See also* BMP, HDF, JPG, PCX, PNG, TIFF, XWD
 - graphics M-files
 - structure of 8-64
 - graphics objects
 - accessing handles 8-50
 - accessing hidden handles 8-67
 - axes 8-11
 - controlling where they draw 8-60
 - copying 8-56
 - deleting 8-58
 - function handle callbacks 8-86
 - functions that create
 - convenience forms 8-15
 - handle validity versus visibility 8-69
 - HandleVisibility property 8-66
 - images 8-11
 - invisible handles 8-66
 - lights 8-11
 - line 8-11
 - patches 8-12
 - properties 8-35
 - changed by functions 8-72
 - changed when created 8-13
 - common to all objects 8-36
 - factory defined 8-42
 - getting current values 8-40
 - listing possible values 8-39
 - querying in groups 8-42
 - search path for default values 8-43
 - searching for 8-52
 - setting values 8-38
 - property names 8-15
 - rectangle 8-12
 - setting parent of 8-14
 - surface 8-12
 - text 8-12
 - graphs
 - annotating 3-2
 - area 5-11–5-13
 - bar 5-2–5-11

- horizontal 5-6
- compass plots 5-31
- contour plots 5-37–5-46
- direction and velocity 5-31–5-36
- discrete data 5-22–5-30
- feather plots 5-32
- generating M-code for 1-44
- histograms 5-17–5-21
- labeling 3-1
- pie charts 5-14–5-16
- quiver plots 5-34
- stairstep plots 5-29
- steps to create 3-D 11-2
- with double axes 10-22

grayscale 6-19

See also intensity images

Greek characters

- using to annotate 3-33

See also text function

griddata 11-9

grids, coincident 10-23

H

Hadamard matrix 11-11

handles to graphics objects 8-50

- finding 8-52

handles, saving in M-files 8-71

HandleVisibility property 8-66

HDF 6-2

hidden 11-12

hidden line removal 11-12

high-level functions 8-14

hist 5-17

histograms 5-17

- in polar coordinates 5-19
- labeling the bins 5-20

- rose plot 5-19
- specifying number of bins 5-20

hold 4-8

- and NextPlot 8-62
- testing state of 8-65

hold state, testing for 8-65

HorizontalAlignment property 3-39

I

image 6-2, 6-21

- properties changed by 8-73

image types

- binary 6-8

images

- 16-bit 6-11
- indexed 6-11
- 8-bit 6-11
- indexed 6-11
- data types 6-4
- erase modes 6-28
- indexed 6-6
- information about files 6-18
- intensity 6-7
- numeric classes 6-2
- printing 6-30
- properties 6-25
- CData 6-25
- CDataMapping 6-25
- XData and YData 6-26
- RGB 6-9
- size and aspect ratio 6-21
- storing in MATLAB 6-4
- truecolor 6-9
- types 6-6

See also graphics images

imagesc 6-2, 6-8

- imfinfo 6-3, 6-18
- imread 6-2, 6-17
- imwrite 6-3, 6-18
- ind2rgb 6-31
- indexed color
 - surfaces 11-13
- indexed images
 - converting the data class of 6-11
- indirgb 6-3
- Infs, avoiding in data 11-6
- intensity images
 - converting the data class of 6-12
- interpolated colors
 - patches 15-9
 - indexed vs. truecolor 15-19
- interpreter property 3-44
- ishold 8-65
- isosurface
 - illustrating flow data 16-19

- J**
- JPEG 6-2

- L**
- labeling
 - axes 3-29
- labeling graphs 3-1, 3-29
- Laplacian of a matrix 11-17
- LaTeX
 - See* TeX
- legend 5-25
- legends
 - with data statistics 2-23
- light 13-4
- lighting 13-2–13-18

- algorithms
 - flat 13-10
 - Gouraud 13-10
 - Phong 13-10
 - ambient light 13-12
 - backface 13-14
 - diffuse reflection 13-11
 - important properties 13-4
 - properties that affect 13-8
 - reflectance characteristics 13-11–13-14
 - specular
 - color 13-14
 - exponent 13-13
 - reflection 13-11
- lighting command 13-10
- limits
 - axes 4-20, 10-17
- line styles
 - used for plotting 4-6
 - redefining 10-37
- lines
 - adding as annotations 3-49
 - adding to existing graph 4-8
 - marker types 4-6
 - removing hidden 11-12
 - styles 4-6
- LineStyleOrder property 10-37
- linspace 11-8
- locking axes position 1-39
- loglog, properties changed by 8-73
- low-level functions 8-14

- M**
- mapping data to color 10-30
- markers used for plotting 4-6
- material command 13-11

- mathematical functions
 - visualizing with surface plot 11-6
 - MATLAB 4 color scheme 4-30
 - MATLAB, quitting 8-69
 - matrix
 - displaying contours 5-38
 - Hadamard 11-11
 - plotting 4-14
 - representing as
 - area graph 5-11
 - bar graph 5-3
 - histogram 5-18
 - surface 11-5
 - storing images 6-4
 - M-code, saving a graph as 1-44
 - mesh 11-5
 - meshc 5-43
 - meshgrid 11-6
 - M-files
 - basic structure of graphics 8-64
 - closereq 8-68
 - to set color mapping 10-34
 - using newplot 8-62
 - writing efficient 8-71
 - movie 5-50, 5-51
 - movies 5-50
 - example 5-51
 - moving
 - objects 1-39
 - MRI data, visualizing 16-8
 - multiaxis axes 10-22
 - multiline text 3-45
- N**
- newplot 8-62
 - example using 8-63
 - NextPlot property 8-61
 - add 8-61
 - replace 8-61
 - replacechildren 8-61, 8-65
 - setting plotting color order 10-36
 - nonuniform data, plotting 11-8
 - NormalMode property 13-9
 - NTSC color encoding 11-20
- O**
- open 1-43
 - OpenGL 9-11, 9-12
 - printing 7-50
 - opening figures 1-43
 - options for copying 1-43
 - organization of Handle Graphics 8-3
 - orient
 - example 7-48
 - orthographic projection 12-34
 - and Z-buffer 12-36
 - OuterPosition property 10-7
- P**
- page setup 1-44
 - painters algorithm 9-11
 - panels
 - contained in figures 8-75
 - panning 2-14
 - paper type
 - setting from the command line 7-46
 - paper type for printing
 - setting from the command line 7-46
 - PaperPosition property
 - example 7-44
 - PaperType property

- example 7-46
- parametric surfaces 11-10
- parent, of graphics object 8-14
- patch
 - behavior of function 15-2
 - interpreting color 15-3
- patches
 - coloring 15-11
 - edges 15-13
 - face coloring
 - flat 15-8
 - interpolated 15-9
 - indexed color 15-16
 - direct 15-17
 - scaled 15-16
 - interpreting color data 15-16
 - multifaceted 15-6
 - single polygons 15-4
 - specifying faces and vertices 15-7
 - truecolor 15-19
 - ways to specify 15-2
- PCX 6-2
- perspective projection 12-34
 - and Z-buffer 12-36
- Phong lighting algorithm 13-10
- pie charts 5-14
 - labeling 5-15
 - offsetting a slice 5-14
 - removing a piece 5-16
- plot 4-3, 4-4
 - properties changed by 8-73
- plot box 12-8
- plot browser 1-11
- Plot Catalog 1-9
- plot edit mode
 - overview 1-37
 - starting and ending 1-38
- plot edit toolbar 3-2
- plot3 11-3
 - properties changed by 8-74
- PlotBoxAspectRatio property 12-44
 - example 12-49
- PlotBoxAspectRatioMode property 12-44
- plottedit 1-38
- plots
 - editing 1-36
- plotting
 - 3-D
 - matrices 11-3
 - vectors 11-3
 - adding to existing graph 4-8
 - annotating graphs 3-1
 - area graphs 5-11
 - bar graphs 5-2
 - compass plots 5-31
 - complex data 4-16
 - contour plots 5-37
 - contours, labeling 5-39
 - creating a plot 4-3
 - data-point markers 4-6
 - elementary functions for 4-2
 - feather plots 5-32
 - interactive 5-48
 - line colors 10-35
 - line styles 4-6
 - matrices 4-14
 - multiple graphs 4-4
 - nonuniform data 11-8
 - overlying bar graphs 5-9
 - quiver plots 5-34
 - specifying line styles 4-5, 10-37
 - stairstep plots 5-29
 - stem plots 5-22
 - surfaces 11-5

- to subaxis 4-27
 - vector data 4-2
 - windows for 4-27
 - plotting statistics 2-24
 - plotting tools 1-4
 - PNG 6-2
 - writing as 16-bit using `imwrite` 6-18
 - Pointer property 9-14
 - pointers
 - custom 9-14
 - example defining 9-15
 - specifying 9-13
 - PointerShapeCData property 9-14
 - PointerShapeHotSpot property 9-14
 - polar 5-46
 - polar coordinates
 - contour plots 5-44
 - rose plot 5-19
 - polygons, creating with `patch` 15-2
 - position of figure 9-5
 - Position property
 - axes 10-5
 - figure 9-5
 - Position property 10-7
 - position rectangle 12-8
 - positioning axes 1-39
 - positioning of axes 10-5
 - positioning text on a graph 3-36
 - preferences 1-43
 - printing
 - 3-D scenes 12-37
 - aspect ratio 7-41
 - default 7-41
 - background color 7-56
 - figure size
 - setting from the command line 7-40, 7-44, 7-84
 - fonts
 - supported for HPGL 7-78
 - supported for PostScript and GhostScript 7-78
 - supported for Windows drivers 7-78
 - images 6-30
 - MATLAB printer driver
 - definition 7-75
 - OpenGL 7-50
 - paper type
 - setting from the command line 7-46
 - PaperType property
 - example 7-46
 - PostScript
 - fonts supported for 7-78
 - quick start 7-30
 - renderer
 - methods 7-49
 - resolution
 - with painters renderer 9-12
 - with Z-buffer renderer 9-12
 - troubleshooting 7-85
 - Z-buffer 9-12
- printing figures 1-44
 - Projection property 12-28
 - projection types 12-34–12-38
 - camera position 12-35
 - orthographic 12-34
 - perspective 12-34
 - rendering method 12-35
 - properties
 - automatic axes 10-25
 - changed by built-in functions 8-72
 - changed by object creation functions 8-13
 - defining in `startup.m` 8-49
 - for labeling axes 10-3
 - naming convention 8-15

- specifying default values 8-45
 - See also* graphics objects
 - Property Editor 1-15
 - property values
 - defaults 8-43
 - defined by MATLAB 8-42
 - getting 8-38
 - resetting to default 8-45
 - setting 8-38
 - specifying defaults 8-45
 - user defined 8-43
- Q**
- quiver 5-31, 5-34
 - quiver plots 5-34
 - 2-D 5-34
 - 3-D 5-35
 - combined with contour plot 5-35
 - displaying velocity vectors 5-36
 - quiver3 5-31
- R**
- realism, adding with lighting 13-2
 - realistic display of objects 12-52
 - reflection, specular and diffuse 13-11
 - Renderer property
 - and printing 9-12
 - Renderer property 11-22
 - RenderMode property 11-22
 - rendering
 - options 9-10
 - Z-buffer 9-11
 - reset 8-61
 - resizing objects 1-39
 - RGB
 - color values 11-14
 - converting to 6-31
 - images 6-9
 - converting the data class of 6-12
 - rgbplot 11-19
 - rose 5-17, 5-19
 - rotating 3-D views 2-15
 - rotating axis labels 3-31
 - rotation
 - about viewing axis 12-32
 - without resizing 12-31
- S**
- saveas 1-42
 - saving figures 1-42
 - saving graphs 1-42
 - scaled color mapping 11-16
 - screen extent, determining 9-6
 - ScreenSize property 9-6
 - example 9-7
 - selecting multiple objects 1-38
 - selection button 1-38
 - semilogx, properties changed by 8-74
 - semilogy, properties changed by 8-74
 - set 8-38
 - ShowHiddenHandles property 8-67
 - size of computer screen 9-6
 - slice planes
 - colormapping 16-17
 - slicing a volume 16-14
 - specular
 - color 13-14
 - exponent 13-13
 - highlight 13-13
 - reflection 13-11
 - SpecularColorReflectance property 13-8

- illustration 13-14
- SpecularExponent property 13-8
 - illustration 13-13
- SpecularStrength property 13-8
 - illustration 13-11
- sphere 11-23
- spline 5-48
- stairs 5-22, 5-29
- stairstep plot 5-29
- starting plot edit mode 1-38
- starting points for stream plots 16-27
- statistics
 - formatting plots of 2-23
 - plotting 2-20, 2-24
 - saving to workspace 2-26
- stem 5-22
- stem plots 5-22
 - 3-D 5-26
 - overlaid with line plot 5-25
- stem3 5-22, 5-26
- stream line plots 16-32
- stream plots
 - starting points 16-27
- stretch-to-fill 12-39
 - overriding 12-47
- string variable, in text 3-44
- subplot 4-27
- surf 11-5
- surfaces
 - CData 11-23
 - coloring 11-13
 - curvature mapped to color 11-17
 - FaceColor 11-23
 - parametric 11-10
 - plotting 11-5
 - nonuniformly sampled data 11-8
 - texturemap 11-23

- surf 5-43
- symbols, TeX characters 3-42

T

- TeX
 - available characters 3-42
 - creating mathematical symbols 3-42
 - symbols in text 3-33, 3-43
- text
 - adding to axes 3-36, 3-42
 - for labeling plots 3-36
 - horizontal and vertical alignment 3-39
 - multiline 3-45
 - placing dynamically, example 3-40
 - placing outside of axes 10-13
 - positioning 3-38
 - TeX characters 3-43
 - using variables in 3-44
- text annotations 3-7
- texture mapping 11-22
- three-dimensional objects, creating with patch 15-2
- tick marks, on axes 4-22, 10-18
- TIFF 6-2
- TightInset property 10-7
- title
 - adding to a graph 3-26
- toolbar
 - buttons 3-49
- toolbar, camera 12-9
- truecolor
 - patches 15-19
 - rendering method used for 11-22
 - surface plots 11-20

U

- uint16 arrays
 - converting to double 6-11, 6-12
 - operations supported on 6-13
 - storing images 6-5
- uint8 arrays
 - converting to double 6-11, 6-12
 - operations supported on 6-13
- uint8 arrays
 - storing images 6-5
- uipanels 8-75
- undo/redo 1-40, 2-17
- units
 - axes 10-6
 - used by figures 9-6
- Units property 10-7
- unlocking axes position 1-39
- unselecting objects 1-39

V

- vectors
 - determined by direction cosines 12-32
 - displaying velocity 5-36
- velocity vectors displayed with quiver 5-36
- vertex normals and back face lighting 13-15
- VertexNormals property 13-9
- VerticalAlignment property 3-39
- Vertices property 15-7
- view
 - azimuth of viewpoint 12-4
 - camera properties 12-28
 - coordinate system defining 12-4
 - definition of 12-2
 - elevation of viewpoint 12-4
 - limitation of azimuth and elevation 12-7
 - MATLAB default behavior 12-29

- projection types 12-34
 - specifying 12-28
 - specifying with azimuth and elevation 12-4
- view 12-4
 - example of rotation 12-31
 - limitations using 12-7
- viewing axis 12-8
 - moving camera along 12-30
- viewpoint, controlling 12-4, 12-5–12-7
- visibility of graphics objects 1-12, 8-69
- visualizing
 - commands for volume data 16-5
 - mathematical functions 11-6
 - steps for volume data 16-4
 - techniques for volume data 16-3
- volume data
 - accessing subregions 16-30
 - examples of 16-3
 - MRI 16-8
 - scalar 16-7
 - slicing with plane 16-14
 - steps to visualize 16-4
 - techniques for visualizing 16-3
 - vector 16-26
 - visualizing 16-3

W

- wire frame surface 11-5, 11-12

X

- XWD 6-2

Z

- Z-buffer 9-11

orthographic projection 12-36
perspective projection 12-36
printing 9-12
rendering truecolor 11-22
zoom 2-11
zooming by setting camera angle 12-31