

ANALYTICAL CHEMISTRY.

BY

F. P. TREADWELL, PH.D.,

Professor of Analytical Chemistry in the Polytechnic Institute of Zurich.

AUTHORIZED TRANSLATION FROM THE GERMAN

BY

WILLIAM T. HALL, S.B.,

Associate Professor of Chemistry, Massachusetts Institute of Technology.

VOLUME II. QUANTITATIVE ANALYSIS.

FIFTH EDITION

TOTAL ISSUE, TWENTY-FIVE THOUSAND

NEW YORK
JOHN WILEY & SONS, INC.
LONDON: CHAPMAN & HALL, LIMITED

1 19

Copyright, 1904, 1910, 1911, 1919,

BY

WILLIAM T. HALL

First and Second Editions entered at Stationers' Hall.

10/20

PRESS OF
BRAUNWORTH & CO.
BOOK MANUFACTURERS
BROOKLYN, N. Y.

TRANSLATOR'S NOTE.

THIS translation has been made from the second German edition, but Professor Treadwell has kindly indicated quite a number of changes which he intends to make in the third edition. Since it has been my aim not so much to prepare an exact literal translation as to publish a book which will be useful to English-speaking students, I am under great obligations to several of my friends and colleagues for suggesting certain other changes. That part of the proof relating to Gravimetric Analysis has been carefully read and criticised by Professor Henry Fay, that relating to Volumetric Analysis by Professor F. Jewett Moore, and Professor Augustus H. Gill has twice read the chapter on Gas Analysis. I have also received valuable assistance in reading the proof from Messrs. R. S. Williams, F. R. Kneeland and J. R. Odell, all of the Massachusetts Institute of Technology. I am indebted to Mr. A. R. Jackson, of Winthrop, for several drawings.

WILLIAM T. HALL.

MASSACHUSETTS INSTITUTE OF TECHNOLOGY,
April, 1904.

The fifth edition of this book contains a number of methods which have never been in the original German text. The methods added have been tested in the laboratories of the Massachusetts Institute of Technology, in nearly every case. I am indebted to a former student, Arthur F. Kaupe, for valuable assistance in finding misprints and errors in the text.

WILLIAM T. HALL.

June, 1919.

iii

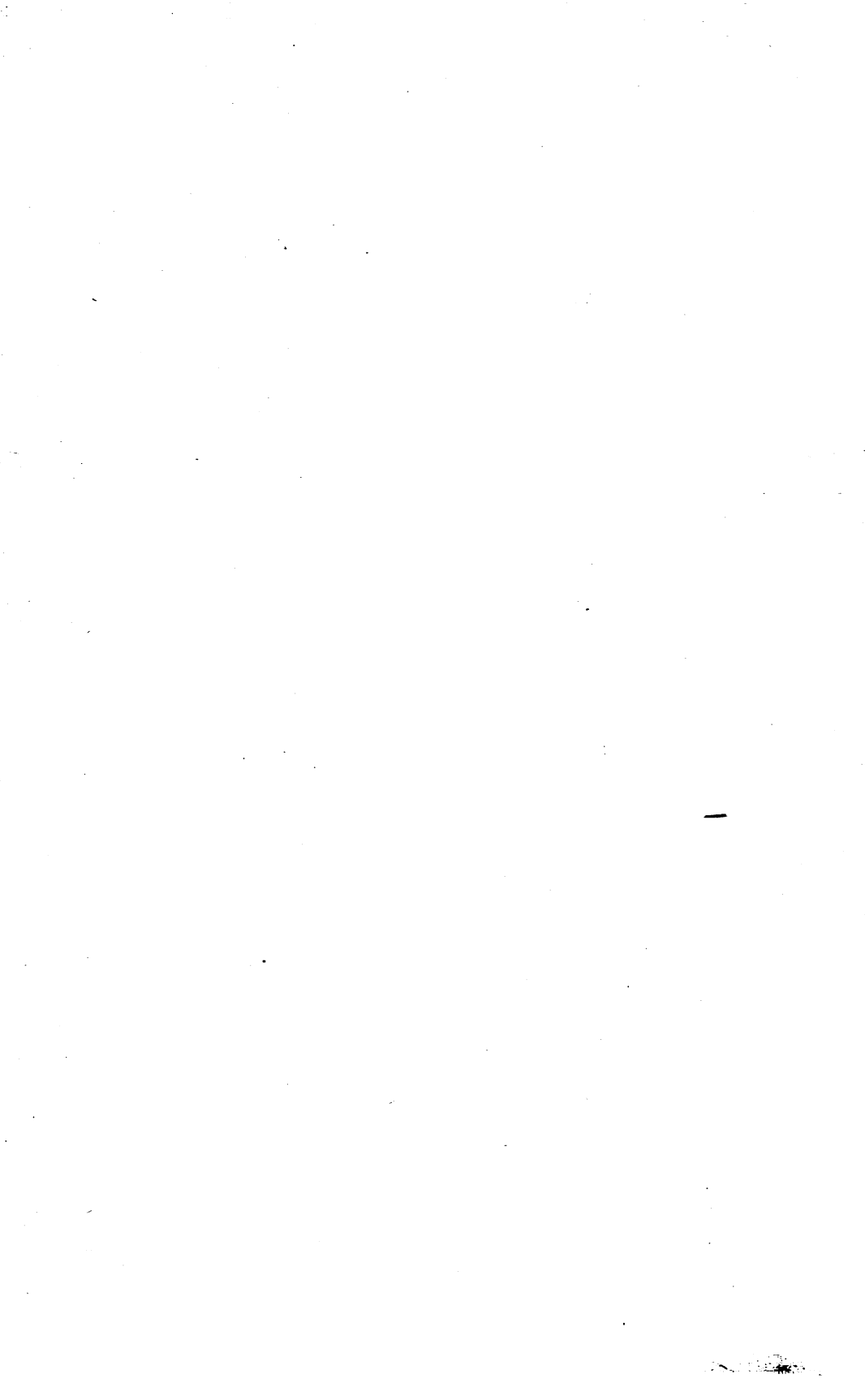

TABLE OF CONTENTS.

INTRODUCTION.

	PAGE
Gravimetric and Volumetric Analysis.....	1
Direct and Indirect Analyses.....	2
Weighing.....	6
Reduction of Weighing to Vacuo.....	13
Testing of Weights.....	15
Filtration and Washing of Precipitates.....	18
Drying and Igniting of Precipitates.....	21
Evaporation of Liquids.....	30
Drying Substances in Currents of Gases.....	33
Preparation of the Substance for Analysis.....	35
Recrystallization.....	35

PART I.

GRAVIMETRIC DETERMINATION OF THE METALS.

GROUP V (ALKALIES).

Potassium.....	38
Sodium.....	43
Separation of Potassium from Sodium.....	43, 50
Lithium.....	53
Determination of Lithium, Potassium, and Sodium.....	53
Ammonium.....	57
Magnesium.....	65
Separation of Magnesium from the Alkalies.....	68

GROUP IV (ALKALINE EARTHS).

Calcium.....	70
Strontium.....	72
Barium.....	74
Separation of Calcium from Magnesium.....	76

	PAGE
Separation of Strontium from Magnesium.....	78
Separation of Barium from Magnesium.....	79
Separation of the Alkaline Earths from One Another.....	79

GROUP III.

Aluminium.....	82
Iron.....	87
Titanium.....	100
Chromium.....	102
Uranium.....	106
Separation of Group III from Group IV.....	107, 147
Separation of Iron from Aluminium.....	107
Separation of Iron, Aluminium, and Phosphoric Acid.....	111
Separation of Iron from Chromium.....	113
Separation of Aluminium from Chromium.....	114
Separation of Iron from Titanium.....	114
Separation of Aluminium from Titanium.....	116
Separation of Uranium from Iron and Aluminium.....	119
Manganese.....	120
Nickel.....	129
Cobalt.....	138
Zinc.....	140
Separation of Manganese, Nickel, Cobalt, and Zinc from the Alkaline Earths.....	147
Separation of the Bivalent from the Other Metals of the Ammonium Sulphide Group.....	149
Separation of Zinc from Nickel, Cobalt, and Manganese.....	156
Separation of Manganese from Nickel and Cobalt.....	161
Separation of Cobalt from Nickel.....	161
Separation of Nickel from Zinc.....	165
Separation of Nickel from Manganese.....	165
Separation of Nickel from Iron.....	166
Removal of Ferric Chloride by Ether.....	167

GROUP II.

(a) Sulpho-Bases.

Mercury.....	168
Lead.....	174
Bismuth.....	179
Copper.....	182
Cadmium.....	189
Separation of the Sulpho-Bases from the Preceding Groups.....	192

TABLE OF CONTENTS.

vii

	PAGE
Analysis of Brass.....	193
Separation of the Sulpho-Bases from One Another.....	194

(b) *Sulpho-Acids.*

Arsenic.....	205
Antimony.....	218
Tin.....	228
Separation of Arsenic, Antimony, and Tin from Members of the Ammonium Sulphide Group.....	235
Separation of Arsenic, Antimony, and Tin from Mercury, Lead, Copper, Cadmium, and Bismuth.....	235
Analysis of Bronzes.....	236
Separation of the Sulpho-Acids from One Another.....	241
Analysis of Bearing Metal.....	252
Gold.....	257
Platinum.....	268
Separation of Gold from Platinum.....	271
Analysis of Commercial Platinum.....	272
Selenium.....	277
Tellurium.....	279
Separation of Selenium and Tellurium from the Metals of Groups III, IV, and V.....	279
Separation of Selenium and Tellurium from Metals of Group II.....	280
Separation of Selenium from Tellurium.....	282
Molybdenum.....	284
Tungsten.....	288
Separation of Molybdenum from Tungsten.....	293
Analysis of Wolframite.....	296
Analysis of Tungsten Bronzes.....	298
Separation of Tungsten from Tin.....	300
Separation of Tungstic Acid from Silica.....	302
Vanadium.....	303
Separation of Vanadium from Arsenic Acid.....	306
Separation of Vanadium from Phosphoric Acid.....	307
Separation of Vanadium from Molybdenum.....	308
Analysis of Vanadinite.....	308
Determination of Vanadium and Chromium in Iron Ores and Rocks.....	310
Determination of Vanadium and Chromium in Pig Iron.....	312
Determination of Vanadium, Molybdenum, Chromium, and Nickel in Steel.....	313

GROUP I.

Silver.....	317
-------------	-----

GRAVIMETRIC DETERMINATION OF THE METALLOIDS.

GROUP I.*

	PAGE
Hydrochloric Acid	320
Analysis of an Insoluble Chloride	323
Free Chlorine	324
Chlorine in Organic Compounds	325
Hydrobromic Acid	329
Hydriodic Acid	330
Separation of the Halogens from One Another	331
Hydrocyanic Acid	337
Determination of Hydrocyanic Acid in the Presence of Halogen Hydride	339
Sulphocyanic Acid	339
Determination of Sulphocyanic and Hydrocyanic Acids	342
Determination of Sulphocyanic Acid and Halogen Hydrides	342
Hydroferrocyanic Acid	342
Hydroferricyanic Acid	344
Hypochlorous Acid	344

GROUP II.

Nitrous Acid	344
Hydrosulphuric Acid, H ₂ S	347
Analysis of Tetrahedrite	359
Acetic Acid	371
Cyanic Acid	371
Determination of Cyanic, Hydrocyanic, and Carbonic Acids	371
Hypophosphorous Acid	372

GROUP III.

Sulphurous Acid	373
Selenous and Tellurous Acids	374
Phosphorous Acid	374
Carbonic Acid	375
Determination of Carbon	398
Determination of Carbon and Hydrogen in Organic Substances	414
Dumas Method for Determining Nitrogen	422
Oxalic Acid	427
Boric Acid	428
Molybdic Acid	433
Tartaric Acid	433
Meta- and Pyrophosphoric Acids	433
Iodic Acid	433

* For the Division of Acids into Groups cf. Vol. I.

TABLE OF CONTENTS.

ix

GROUP IV.

	PAGE
Phosphoric Acid	434
Determination of Phosphorus and Silicon in Iron and Steel	440
Separation of Phosphoric Acid from the Metals	448
Thiosulphuric Acid	450

GROUP V.

Nitric Acid	451
Chloric Acid	460
Perchloric Acid	462

GROUP VI.

Sulphuric Acid	464
Hydrofluoric Acid	471
Separation of Phosphoric and Hydrofluoric Acids	474
Separation of Fluorine from the Metals	481
Separation of Fluorine from the Acids	482
Hydrofluosilicic Acid	483

GROUP VII.

Silicic Acid	485
Analysis of Silicates	491
Determination of Zirconium and Sulphur in Rocks	505
Analysis of Chromite	509
Determination of Thorium in Monazite	510
Determination of Water in Silicates	512

PART II.

VOLUMETRIC ANALYSIS.

Measuring Instruments	514
Normal Volume and Normal Temperature	516
Calibration of Measuring Flasks	522
Calibration of Pipettes	524
Calibration of Burettes	527
Normal Solutions	530

I. ACIDIMETRY AND ALKALIMETRY.

Indicators	538
Alkalimetry	558
Acidimetry	571

II. OXIDATION AND REDUCTION METHODS.

	PAGE
Permanganate Methods	596
Potassium Dichromate Methods	641
Iodimetry	644
Reduction Methods	697

III. PRECIPITATION ANALYSES.

Determination of Silver	702
Determination of Halogens	707
Determination of Cyanogen	710
Determination of Sulphocyanic Acid	712
Determination of Sulphuric Acid	714
Determination of Phosphoric Acid	718
Determination of Nickel	720
Determination of Copper	724
Determination of Lead	726

PART III.

GAS ANALYSIS.

The Collection and Confinement of Gas Samples	730
Calibrating Gas Measuring Instruments	743
Purification of Mercury	747
Determination of Carbon Dioxide	750
Ethylene	751
Benzene	752
Acetylene	754
Separation of the Heavy Hydrocarbons	756
Oxygen	757
Carbon Monoxide	762
Hydrogen	770
Methane	774
Analysis of Illuminating and Producer Gas	775
Technical Gas Analysis	786
Method of Hempel	768
Method of Winkler-Dennis	794
Orsat's Apparatus	797
Bunte's Apparatus	798
Analysis of Gases which are Absorbed by Water	800
Nitrous Oxide	800
Nitric Oxide	802

TABLE OF CONTENTS.

xi

	PAGE
Nitrogen.....	806
Analysis of Gases by Titration.....	808
Chlorine.....	808
Hydrochloric Acid.....	814
Sulphur Dioxide.....	815
Hydrogen Sulphide.....	816
Ethylene.....	818
Gas-Volumetric Methods.....	822
Determination of Ammonia in Ammonium Salts.....	822
Determination of Nitrous and Nitric Acids.....	825
Hydrogen Peroxide Methods.....	826
Standardization of Permanganate Solutions.....	827
Determination of Cerium in Soluble Salts.....	828
Silicon Fluoride.....	828
Determination of Fluorine.....	829
Determination of Vapor in Gas Mixtures.....	831

APPENDIX I.

The Influence of Fine Grinding on Composition.....	837
The Use of Cupferron in Quantitative Analysis.....	838
Preparation of Cupferron.....	840
The Determination of Iron in Manganese Ores.....	841
Manganese in Ferromanganese.....	842
Nickel and Cobalt.....	843
The Determination of Titanium Dioxide in Titanium-Iron Ore.....	844
Determination of Sulphur in Pyrite: Fusion with Sodium Peroxide.....	848
A Rapid Method for the Determination of Sulphur in Steel.....	850
The Determination of Chromium in Steel.....	854
By the Barba Method.....	854
By Sodium Bismuthate.....	856
Determination of Tungsten in Ores.....	858
Determination of Phosphorus in Steel.....	861
Analysis of Portland Cement.....	864

APPENDIX II.

Specific Gravity of Acids.....	869
Specific Gravity of Alkalies.....	871
Tension of Aqueous Vapor.....	874
Heats of Combustion of Gases.....	876
Tables for Calculating Analyses.....	877
International Atomic Weights.....	883
Table of Chemical Factors.....	884
Logarithms.....	888
INDICES.....	895

QUANTITATIVE ANALYSIS.

INTRODUCTION.

THE purpose of a quantitative analysis is to determine the quantity of the constituents present in a compound or in a mixture. The methods to be employed depend upon the nature of the substances to be determined, so that *in every case a qualitative analysis should precede the quantitative one*. In quantitative analysis we distinguish two essentially different methods of procedure:

- I. GRAVIMETRIC ANALYSIS (Analysis by Weight).
- II. VOLUMETRIC ANALYSIS (Analysis by Volume).

In the case of *gravimetric analysis* we separate the component to be determined from a solution in the form of an insoluble compound of known chemical composition, and then determine the weight of this compound; from this we can calculate the amount of the substance present.

Suppose, for example, that we have for analysis a sample of barium chloride. The amount of barium present can be determined by dissolving a weighed amount of the chloride in water, precipitating the barium from the solution by the addition of sulphuric acid and weighing the insoluble barium sulphate formed.

If we start with a grams of barium chloride and obtain p grams of barium sulphate, the amount of barium present may be calculated as follows:

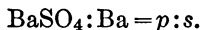

$$s = \frac{\text{Ba}}{\text{BaSO}_4} \cdot p = \text{weight of barium in } a \text{ gm. of barium chloride.}$$

It is, however, customary to express the results in percentages; therefore in this case we have

$$a : \frac{\text{Ba}}{\text{BaSO}_4} \cdot p = 100 : x$$

$$x = \frac{100 \cdot \text{Ba}}{\text{BaSO}_4} \cdot \frac{p}{a} = \text{per cent. barium.}$$

In the case of *volumetric analysis* the constituents are not weighed, but they are determined by measuring the amounts of reagents of known strength which react with them.

Suppose that we have a sample of caustic soda which contains some sodium chloride as an impurity and that we desire to know how much caustic soda there is in 100 gms. of the mixture. A portion of the substance weighing a gms. is dissolved in water, some methyl orange is added and hydrochloric acid of known strength is then run into the solution from a burette until the alkali is just neutralized, this point being reached when the yellow color of the solution changes to pink. If t c.c. of hydrochloric acid were necessary, of which 1 c.c. contained exactly α gms. of HCl, it is evident that to neutralize the caustic soda contained in a gms. of the mixture $\alpha \cdot t$ gms. of HCl were used up, and it follows:

$$\text{HCl} : \text{NaOH} = \alpha \cdot t : s$$

$$s = \frac{\text{NaOH}}{\text{HCl}} \cdot \alpha \cdot t = \text{gms. NaOH in } a \text{ gms. of the mixture; in 100 gms.}$$

$$a : \frac{\text{NaOH}}{\text{HCl}} \cdot \alpha \cdot t = 100 : x$$

$$x = \frac{100 \cdot \text{NaOH} \cdot \alpha \cdot t}{\text{HCl} \cdot a} = \text{per cent NaOH.}$$

We will first consider

A. GRAVIMETRIC METHODS.

These are divided into

- (a) *Direct Analyses.*
- (b) *Indirect Analyses.*

In the case of a *direct analysis* the substance to be determined is separated from the solution in the form of an insoluble compound and weighed.

The determination of barium in barium chloride was an example of a direct analysis.

The indirect method depends upon the fact that when two or more substances are made to undergo the same chemical treatment they experience a relatively different change of weight.

For example, suppose that we have a mixture of the chlorides of sodium and of potassium and desire to determine the relative amounts of each of the two substances in the mixture. For this purpose a portion of the mixture (a gms.) is weighed, dissolved in water, the chlorine precipitated as silver chloride, and the weight of the latter determined (p gms.). From these data it is possible to calculate the amount of sodium chloride and of potassium chloride that was present in the mixture.

If we let x represent the amount of the sodium chloride, y the amount of the potassium chloride, α the amount of silver chloride formed from x gms. of sodium chloride, and β the amount of silver chloride formed from y gms. of potassium chloride, then

$$\begin{array}{l} \text{NaCl} \quad \text{KCl} \\ x + y = a \end{array}$$

$$\begin{array}{l} \text{AgCl} \quad \text{AgCl} \\ \alpha + \beta = p. \end{array}$$

We have, therefore, two equations with apparently four unknown quantities, but α and β can be expressed in terms of x and y :

$$\begin{array}{l} \text{NaCl}:\text{AgCl}=x:\alpha \\ \alpha = \frac{\text{AgCl}}{\text{NaCl}} \cdot x \end{array}$$

$$\begin{array}{l} \text{KCl}:\text{AgCl}=y:\beta \\ \beta = \frac{\text{AgCl}}{\text{KCl}} \cdot y \end{array}$$

$\frac{\text{AgCl}}{\text{NaCl}}$ and $\frac{\text{AgCl}}{\text{KCl}}$, however, are known quantities; they are simply the quotients of the molecular weights in question.

If we designate by m the fraction $\frac{\text{AgCl}}{\text{NaCl}}$ and by n the fraction $\frac{\text{AgCl}}{\text{KCl}}$, we have

$$\begin{array}{l} x + y = a \\ mx + ny = p \end{array}$$

and from this we can calculate

$$x = \frac{p-n \cdot a}{m-n} \text{ and } y = a - x$$

or

$$x = \frac{1}{m-n} \cdot p - \frac{n}{m-n} \cdot a.$$

All indirect analyses may be calculated by means of this last general equation.

In the above example

$$m = \frac{\text{AgCl}}{\text{NaCl}} = \frac{143.34}{58.46} = 2.4520, \quad n = \frac{\text{AgCl}}{\text{KCl}} = \frac{143.34}{74.56} = 1.9223$$

and

$$m - n = 0.5297.$$

If these values are substituted in the above equations we obtain

$$x = 1.888 \cdot p - 3.628 \cdot a.$$

Consequently, in order to determine the amount of sodium chloride in the original mixture it is only necessary to determine the values a and p , then multiply them by the coefficients 3.628 and 1.888 respectively, and subtract the first product from the last.

Although this method appears so simple and attractive on paper, impossible values are often obtained in practice, so that it is always necessary to be very cautious about using an indirect method.

The experimental errors which are unavoidable in such an analysis are multiplied by the value of the coefficients; thus in the above case the actual error in the determination of the weight a is multiplied by 3.63 . . . and the error in determining the weight of the silver chloride (p) is multiplied by 1.89 . . .

It is clear, therefore, that an indirect analysis becomes more accurate in proportion as the coefficients are small and when the error in determining a and p is slight.

In the above example the coefficients are relatively small and consequently good results are to be expected, and experiment shows this to be the case.

Example: A mixture weighing 0.5480 gm. (a) and consisting of

0.4966 gm. sodium chloride (x) and 0.0514 gm. potassium chloride (y) yielded 1.3161 gm. of silver chloride (p), but from the values of a and p we can calculate those of x and y :

$$\begin{aligned}x &= 1.888 \cdot 1.3161 - 3.628 \cdot 0.5480 \\ &= 0.4963 \text{ gm. sodium chloride;} \\ y &= 0.0517 \text{ gm. potassium chloride.}\end{aligned}$$

The calculated values, therefore, show

99.92 per cent. of the true value for the sodium chloride,
100.6 per cent. of the true value for the potassium chloride.

Although the above results are satisfactory, it must be borne in mind that the analysis was carried out with chemically pure substances. If this were not so, as is usually the case in practice, the results would be far less accurate.

The same analysis may be performed in a much more simple manner than as above described, by weighing the mixture of the chlorides in a platinum crucible, then changing them to sulphates (by treatment with sulphuric acid and evaporating off the excess of the latter) and again weighing. In this case the actual experimental error is slight and excellent results might be expected.

We have

$$\begin{array}{r} \text{NaCl} \quad \text{KCl} \\ x + y = a \\ \text{Na}_2\text{SO}_4 \quad \text{K}_2\text{SO}_4 \\ \alpha + \beta = p \\ \alpha = \frac{\text{Na}_2\text{SO}_4}{2\text{NaCl}} \cdot x \quad \text{and} \quad \beta = \frac{\text{K}_2\text{SO}_4}{2\text{KCl}} \cdot y \end{array}$$

$$\frac{\text{Na}_2\text{SO}_4}{2\text{NaCl}} = 1.2150 = m \quad \text{and} \quad \frac{\text{K}_2\text{SO}_4}{2\text{KCl}} = 1.1686 = n$$

$$m - n = 0.0464$$

Now

$$(1) \quad x + y = a$$

$$(2) \quad mx + ny = p$$

and

$$(3) \quad x = \frac{1}{m-n} \cdot p - \frac{n}{m-n} \cdot a.$$

Substituting the values for m and n in equation (3) we obtain

$$x = 21.547 \cdot p - 25.181a.$$

In this case the coefficients are very large, so that the analytical error is multiplied enormously in the calculation, so much so that it is impossible to obtain even approximate values except when the mixture is composed of about equal parts of the two chlorides.

Example: In a mixture containing about equal parts of the two salts there was found

- 99.64 per cent. of the sodium chloride present;
- 100.76 per cent. of the potassium chloride present.

In a mixture containing considerable sodium chloride and **little** potassium chloride there was found

- (a) 95.0 per cent. of the sodium chloride present;
- 148.0 per cent. of the potassium chloride present.
- (b) 96.8 per cent. of the sodium chloride present;
- 129.9 per cent. of the potassium chloride present.

The values obtained are, therefore, worthless.

In the case of a direct analysis the small unavoidable errors exert a much less influence upon the result, so that a direct determination should always be preferred.

Only in those cases where a direct method is unknown should one resort to an indirect analysis!

OPERATIONS.

The principal operations of quantitative analysis are those of weighing, filtration, and the washing, drying, and ignition of precipitates.

Weighing.

The balance, as used for purposes of quantitative chemical analysis, is shown in Fig. 1.

It consists of a horizontal lever with two arms of equal length, and in order to be serviceable it must be *accurate* and *sensitive*.

It fulfils the first condition if

- (1) The arms of the lever are equally long;

(2) The point of support (the fulcrum) lies above the centre of gravity;

(3) The fulcrum (a knife-edge) and the knife-edges from which the pans are suspended lie in the same plane and are parallel to one another.

The balance is more sensitive the greater the displacement of the position of equilibrium brought about by the addition of a small weight, e.g. one milligram.

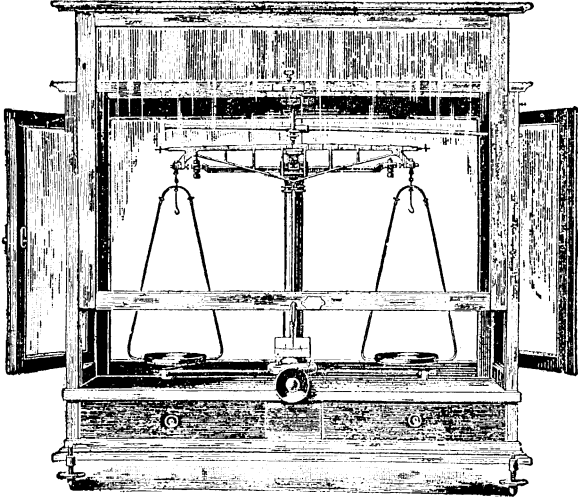

FIG. 1.

The sensitiveness, or *sensibility*, may be expressed by the equation:

$$\tan \alpha^* = \frac{p \cdot l}{q \cdot d}$$

in which p is the weight added, l the length of the balance-arm, q the weight of the beam, and d the distance between the centre of gravity and the point of support.

The sensitiveness of the balance is greater, therefore, the heavier the weight added, the longer the beam, the lighter the beam, and the shorter the distance between the centre of gravity and the point of support.

* α is the angle through which the pointer moves on the addition of the small weight.

For convenience in determining the position of the balance, a pointer is fastened to the beam which, when the equilibrium is established, rests at the zero of a scale on an ivory plate below.

The object to be weighed is placed upon the left scale-pan and the weights upon the right pan; the beam is lowered and the balance set in slight motion, by producing, with the hand, a gentle draft of air upon one of the pans. If the correct weight has been added, the pointer will swing to the same number of scale divisions to the right of the zero that it does to the left, provided that it does so when there is nothing in either scale-pan, which is usually not the case. It is to be noted that when the zero-point of the balance (i.e., the point of the scale at which the pointer rests when the balance is in equilibrium with nothing in either scale-pan) coincides with the zero of the scale, it may change during the course of the day, so that disregard of this fact may lead to a considerable error.

The cause of the displacement of the zero-point is that the first condition for the accuracy of a balance is not fulfilled. On account of unequal warming the arms become of unequal length.

In order that accurate weighings may be obtained, it is necessary to make them independent of any inequality in the lengths of the arms, which can readily be done, as the following consideration will show. In the case of a lever, equilibrium takes place when the statical moments are equal.

By *statical moment* is understood the product of the force into the length of the lever-arm, and the length of the lever-arm is the perpendicular distance from the axis of revolution (the fulcrum) to the line of action of the force.

If an object, whose weight Q (Fig. 2) is to be ascertained, is placed upon the left balance-pan and equilibrium is established (the pointer rests at zero) by putting weights amounting to F gms. in the right balance-pan, then

$$(1) \quad Ql = Pl_1.$$

If now the object Q is placed on the right-hand balance-pan and the balance again brought to the state of equilibrium by placing weights upon the left-hand balance-pan, in this case the weights

will not as a rule amount to P gms., but to P_1 gms. Since, however, equilibrium has been reached, we have

$$(2) Ql_1 = P_1l.$$

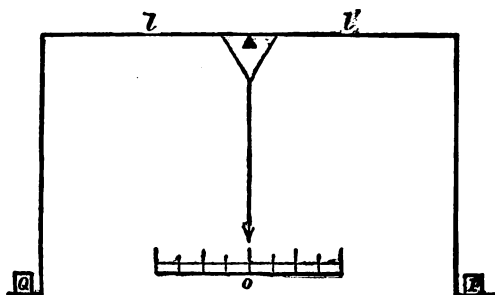

FIG. 2.

If equation 1 is multiplied by equation 2, we obtain

$$Q^2l_1 = P_1Pl_1$$

$$Q^2 = P_1P$$

$$Q = \sqrt{P_1P}$$

The true weight is obtained, therefore, by taking the geometric mean of the two values. For practical purposes, however, it is sufficiently accurate to take the arithmetical mean, in which case the true weight of the object would be:

$$Q = \frac{P + P_1}{2}$$

This method of obtaining the true weight independent of the lengths of the balance-arms is known as that of *double weighing*.

The same end is obtained by Borda's *method of substitution*.

According to this method the object to be weighed (Q) is counterbalanced (tared) by means of shot, sand, weights, etc., the object Q is then removed and equilibrium with the tare is again established by placing weights upon the scale-pan. We have, then, as a result of the first weighing,

$$Ql = Tl_1$$

and from the second weighing,

$$Pl = Tl_1$$

from which it follows:

$$Ql = Pl$$

$$Q = P.$$

The latter method is used chiefly in weighing large objects.

For ordinary analytical work the weighing is made by the *method of swings*.

First of all the zero-point of the balance is determined by setting the balance in motion (without any load in either pan), observing

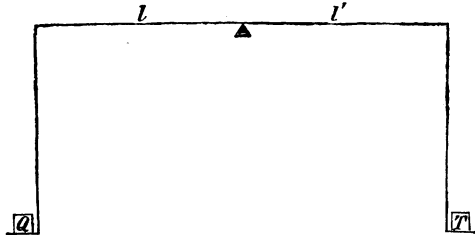

FIG. 3.

and recording the turning-points, or extreme positions, of the pointer on the scale of an uneven number of swings (say five*) and taking the mean of the readings. In order to give the same algebraic sign to all the observed readings it is best to number the divisions on the scale from left to right from 0 to 20 so that the zero-point in case both balance-arms were of equal length would be numbered 10.

The next thing to be determined is the sensitiveness of the balance for the object to be weighed. For this purpose the object is placed in the left-hand balance-pan, and by placing weights in the right-hand pan equilibrium is established as nearly as possible

*The first two swings are inaccurate on account of the jar in shutting the balance-door, etc., so that they are disregarded.

and the point of rest of the pointer on the scale is determined as above. An additional weight of 1 mgm. is added, or removed if the object was too light before, and the point of rest is again determined.

The difference (d) between this and the previous point of rest gives the sensitiveness of the balance. Assuming the zero-point to lie at 10.22, the first point of rest, obtained with a load of 19.723 gms., to be at 9.80, and the point of rest with a load of 1 mgm. less (i.e., with a load of 19.722 gms.) to lie at 12.32, then the sensitiveness of the balance will amount to $12.32 - 9.80 = 2.52$ scale divisions.

As the zero-point of the balance was at 10.22 and the point of rest with a load of 19.723 gms. was 9.80, it follows that the object was lighter than the weights in the right-hand pan, and in fact the excess of weights in the pan was sufficient to move the point of rest $10.22 - 9.80 = 0.42$ divisions on the scale. This amount can be calculated from the determination of the sensitiveness of the balance as follows:

Since 2.52 of the scale divisions correspond to 1 mgm., then 0.42 of the scale divisions correspond to the weight which must be subtracted from 19.723 gms. in order to obtain the true weight; therefore

$$2.52:1=0.42:x$$

$$x = \frac{0.42}{2.52} = 0.17 \text{ mgm., or about } 0.2 \text{ mgm.}$$

The true weight of the body in air is consequently

$$19.723 - 0.0002 = 19.7228 \text{ * gms.}$$

In making a weighing one should always accustom himself to note the observations methodically, as follows:

Assume that a platinum crucible is to be weighed.

* As most analytical balances will scarcely detect with certainty less than $\frac{1}{10}$ mgm., the weight is expressed only to the fourth decimal. If the fifth decimal place in a calculation amounts to six or more, the number in the fourth decimal place is increased one.

Zero-point.		I. Point of Rest with Load of 12.052 gms.		II. Point of Rest with Load of 12.053 gms.	
Left.	Right.	Left.	Right.	Left.	Right.
4.2	17.6	5.8	18.7	3.5	15.8
4.6	17.1	6.2	18.3	3.8	15.4
5.1	6.6	4.2	
Sum = 13.9	34.7	18.6	37.0	11.5	31.2
Mean = 4.63	17.35	6.2	18.5	3.83	15.60
.....	4.63	6.2	3.83
Sum of both means = 21.98	24.7	19.43
Mean = 10.99	12.35	9.71

Sensitiveness = $12.35 - 9.71 = 2.64$ scale divisions.

$12.35 - 10.99 = 1.36$ scale divisions.

$1.36 : 2.64 = 0.5$ mgm.

Weight of crucible = $12.052 + 0.0005 = 12.0525$ gms.

The sensitiveness of a balance varies slightly with the load. It is simplest to determine once for all the sensitiveness for 50 gms., 20 gms., 10 gms., 5 gms., and 2 gms., place a card in the balance with the results obtained and use the numbers as required.

In this way the sensitiveness of a balance

with a load of	was found to equal
50 gms.	2.23 scale divisions
20 "	2.28 " "
10 "	2.64 " "
5 "	2.66 " "
2 "	2.66 " "

The determination of the zero-point, however, must be made with every weighing. If a number of weights are to be made one after another it suffices to determine the zero-point at the beginning and at the end and to use the mean of the two determinations. In case of very heavy loads, however, the zero-point should be determined before and after each weighing and the mean value used.

Reduction of Weighing to Vacuo.

Since most of our weighings are made in the air with brass weights, we are constantly introducing an error due to the displacement of air. This error is so small that it can be disregarded in ordinary analyses; in the case of the most accurate work, however, as in atomic weight determinations, calibrations of measuring vessels, etc., it should never be neglected. In such cases the apparent weight must be reduced to vacuo as follows: 1 c.c. of air at 15° C. and 760 mm. pressure weighs 0.0012 gm. = λ .

The specific gravity of brass is $8.0 = s'$.*

The specific gravity of the substance weight = s .

The body that weighs p_0 gms. *in vacuo* will be balanced by p gms. in the air.

The loss in weight of the substance is $\frac{p_0}{s} \lambda$ gms.

The loss in weight of the brass weights is $\frac{p}{s'} \lambda$ gms.

The total loss therefore, = $\left(\frac{p_0}{s} \lambda - \frac{p}{s'} \lambda \right)$.

The weight of air was given to two significant figures, † and hence the loss in weight due to displacement of air will be accurate only to two significant figures when this value is used. The values p and p_0 will be the same as regards the first two significant figures. We may substitute, therefore, the fraction $\frac{p\lambda}{s}$ for $\frac{p_0\lambda}{s}$ in the above expression for the total loss in weight and the weight of the substance *in vacuo* is:

$$p_0 = p \left[1 + \frac{\lambda}{s} - \frac{\lambda}{s'} \right].$$

* Brass has a density of 8.4, but the density of most analytical weights is nearer 8.0.

† Significant figures are counted from the decimal point beginning with the first digit other than zero. Thus the numbers 1030. and 0.00103 each have three significant figures. It is never safe to assume that the next figure would be a zero and when one value is multiplied or divided by another the accuracy of the result cannot be greater than that of the least accurate of the original numbers. In all scientific measurements care should be taken to give as many and no more figures as are consistent with the accuracy involved.

Instead of making the computation, the following table of Kohlrausch may be used:

REDUCTION OF A WEIGHING MADE WITH BRASS WEIGHTS TO VACUO.
METHOD OF F. KOHLRAUSCH.

<i>s</i>	<i>k</i>	<i>s</i>	<i>k</i>	<i>s</i>	<i>k</i>
0.7	+1.56	2.0	+0.45	8	-0.00
0.8	1.35	2.5	0.33	9	0.017
0.9	1.18	3.0	0.25	10	0.030
1.0	1.05	3.5	0.19	11	0.041
1.1	0.94	4.0	0.15	12	0.050
1.2	0.85	4.5	0.12	13	0.058
1.3	0.77	5.0	0.09	14	0.064
1.4	0.71	5.5	0.07	15	0.070
1.5	0.65	6.0	0.05	16	0.075
1.6	0.60	6.5	0.03	17	0.079
1.7	0.56	7.0	0.02	18	0.083
1.8	0.52	7.5	0.01	19	0.087
1.9	0.48	8.0	+0.00	20	0.090
2.0	+0.45			21	-0.093

$k = 1.20 \left(\frac{1}{s} - \frac{1}{8.0} \right)$ mgm. If a substance of specific gravity *s* weighs *g* grams in the air, then *g*·*k* mgms. are to be added to the weight in air in order to obtain the weight in vacuo.

Testing of Weights.

Although it is now possible to buy nearly perfect weights, yet their accuracy should always be tested.

For almost all analytical purposes it matters not whether the 50 gm. weight weighs exactly 50 gms., but it is essential that the individual weights represent the corresponding relations to one another.

In most sets of weights the following are found: 50 gm., 20 gm., 10 gm., 10' gm., 5 gm., 2 gm., 1 gm., 1' gm., 1'' gm., 0.5 gm., 0.2 gm., 0.1 gm., 0.1' gm., 0.05 gm., 0.02 gm., 0.01 gm., 0.01' gm.; a rider (weighing either 10 or 12 mgms. according as to whether the balance-arm is divided into 10 or 12 equal parts between the fulcrum and the point of suspension of the right-hand balance-pan); and usually smaller weights weighing 5, 2, 1, 1, 1 mgms.

The weights may be tested in the following manner:*

The assumption is first made that the sum of the larger weights is equal to 100 gms. = 100,000 mgms., and the weights of the single pieces obtained by the method of double weighing are compared with one another, e.g.:

$$50 \text{ gm. wt. against } 20 + 10 + 10' + 5 + 2 + 1 + 1' + 1''$$

and it is found:

$$\begin{array}{l} \text{Left} \qquad \qquad \qquad \text{Right} \\ (1) \ 50 \text{ gm.} + 0.31 \text{ mgm.} = (20 + 10 + 10' + \dots) \\ \text{Left} \qquad \qquad \qquad \text{Right} \\ (2) \ (20 + 10 + 10' + \dots) = 50 \text{ gm.} + 0.61 \text{ mgm.} \end{array}$$

from which it follows:

$$50 \text{ gm.} + \frac{0.31 \text{ mgm.} + 0.61 \text{ mgm.}}{2} = 50 \text{ gm.} + 0.46 \text{ mgm.} \\ = (20 + 10 + 10' + \dots)$$

or

$$50 \text{ gm.} = (20 + 10 + 10' + \dots) - 0.46 \text{ mgm.}$$

* Kohlrausch, Leitfaden der prakt. Phys., V. Auflage, p. 34. See also T. W. Richards, Journ. Am. Chem. Soc. (1900) XXII, 144, where the method used at Harvard is described.

The other weights are compared in the same way, obtaining, for example,

$$\begin{array}{rcl}
 50 \text{ gm.} & = & (20 + 10 + 10' + \dots) \text{ gm.} + A \text{ mgm.} \\
 20 \text{ " } & = & 10 + 10' & + B \text{ " } \\
 10' \text{ " } & = & 10 & + C \text{ " } * \\
 (5 + 2 + 1 + \dots) & = & 10 & + D \text{ " }
 \end{array}$$

in which A , B , C , and D may be either positive or negative.

The sum of the weights ($50 + 20 + 10 + 10' + \dots$) was assumed to equal 100 gms., and with the help of the preceding equations each weight is expressed in terms of the 10 gm. weight; then

$10 \times 10 + A + 2B + 4C + 2D = (50 + 20 + 10 + \dots) = 100$ gms. and the 10 gm. weight itself:

$$10 = 10 - \frac{A + 2B + 4C + 2D}{10}.$$

If we let $S = \frac{A + 2B + 4C + 2D}{10}$, then we obtain

$$\begin{array}{rcl}
 10 & = & 10 \text{ gm.} - S \\
 10' & = & 10 \text{ gm.} - S + C \\
 5 + 2 + 1 + 1' + 1'' & = & 10 \text{ gm.} - S + D \\
 20 & = & 20 \text{ gm.} - 2S + B + C \\
 50 & = & 50 \text{ gm.} - 5S + A + B + 2C + D \\
 & = & 50 \text{ gm.} + \frac{1}{2}A
 \end{array}$$

The sum $\frac{1}{2}A + B + 2C + D - 5S$ should equal 0, which serves as a test for the accuracy of the observations.

The 5 gm. weight is now compared with the $2 + 1 + 1' + 1''$ in exactly the same way, with the result that

$$\begin{array}{rcl}
 5 & = & 2 + 1 + 1' + 1'' + a \\
 2 & = & 1 + 1' & + b \\
 1' & = & 1 & + c \\
 1'' & = & 1 & + d.
 \end{array}$$

* It is well to mark the weights of the same denomination so that they may be distinguished from one another.

According to the preceding work

$$5 + 2 + 1 + 1' + 1'' = 10,000 - S + D$$

consequently

$$10 \times 1 + a + 2b + 4c + 2d = 10,000 - S + D$$

and

$$1 = 1000 - \frac{a + 2b + 4c + 2d + S - D}{10}.$$

If we let $s = \frac{a + 2b + 4c + 2d + S - D}{10}$, we obtain

$$\begin{aligned} 1 &= 1000 - s \\ 1' &= 1000 - s + c \\ 1'' &= 1000 - s + d \\ 2 &= 2000 - 2s + b + c \\ 5 &= 5000 - 5s + a + b + 2c + d. \end{aligned}$$

In the same way the smaller weights are tested until finally the following correction table is obtained.

TABLE FOR CORRECTION OF WEIGHTS.

50 = 50 g. + $\frac{1}{2}A$ 20 = 20 g. - $2S + B + C$ 10 = 10 g. - S 10' = 10 g. - $S + C$	$5 + 2 + 1 + 1' + 1'' =$ $\frac{10}{10}$ $= 10 \text{ g.} - S + D$	$0.5 + 0.2 + 0.1 + 0.1'$ $+ d^* =$ $\frac{1}{1 \text{ g.} - S + \alpha}$	$\frac{0.1}{d = 0.1 \text{ g.} - s' + \sigma}$
$5 \left. \begin{array}{l} 2 \\ 1 \\ 1' \\ 1'' \end{array} \right\} = 10 \text{ g.} - S + D$	$5 = 5 \text{ g.} - 5s + a + b +$ $+ 2c + d$ $2 = 2 \text{ g.} - 2s + b + c$ $1 = 1 \text{ g.} - s$ $1' = 1 \text{ g.} - s + c$ $1'' = 1 \text{ g.} - s + d$	$0.5 = 1 \text{ g.} - 5s' + \beta +$ $+ \gamma + 2\delta + \sigma$ $0.2 = 0.2 \text{ g.} - 2s' + \gamma +$ $+ \delta$ $0.1 = 0.1 \text{ g.} - s'$ $0.1' = 0.1 \text{ g.} - s' + \delta$ $d = 0.1 \text{ g.} - s' + \sigma$	$0.05 = 0.5 \text{ g.} - 5s'' + l +$ $+ m + 2n + o$ $0.02 = 0.02 \text{ g.} - 2s'' +$ $+ m + n$ $0.01 = 0.01 \text{ g.} - s''$ $0.01' = 0.01 \text{ g.} - s'' + n$ $\text{Rider} = 0.01 \text{ g.} - s'' + o$
Sum = 100 g.	10 g. - $S + D$	1 g. - $s + \alpha$	0.1 g. - $s' + \sigma$

* $d = 0.05 + 0.02 + 0.01 + 0.01' + \text{Rider}$. (Rider = 0.01 g.)

The milligram weights may be standardized in exactly the same manner. It is much more convenient, however, and the accuracy attained is almost exactly the same, if instead of using these very small weights the rider is hung upon the whole divisions of the balance-arm in order to obtain the weight in milligrams; for the estimation of the fractions of the milligram it is better to calculate them from the sensitiveness of the balance.

The weights should never be touched with the fingers, but should always be lifted by means of the pincers provided with each set, and nothing should be placed on or removed from the balance-pans without arresting the balance, i.e., raising the mechanical supports so that the beam no longer rests upon its knife-edges.

Filtration and Washing of Precipitates.

How large should the filter be and how many times should the precipitate be washed?

With regard to the latter question it is evident that the precipitate should be washed until the soluble matter is completely removed. It is clear, however, that this point will never be reached because a part of the solution always remains on the filter, but it is not difficult to make the amount of the dissolved substance remaining so small as to be negligible. When the amount of dissolved substance remaining on the filter is so small that it could not be detected by our balance, we consider the precipitate to be completely washed.

The aim should be not only to remove all of the soluble matter, but to accomplish this with as little wash water as possible.

No precipitate is absolutely insoluble, so that it is clear that every unnecessary excess of wash water causes harm by removing a fraction of the precipitate, and the greater the excess of the wash water the greater the amount of the precipitate dissolved.

The amount of wash water to be used depends largely upon the nature of the precipitate itself. Amorphous, gelatinous precipitates always require more washing than crystalline, granular ones.* As a rule, it may be said that the process of washing must be continued until the substance which is being washed out can be no longer detected in the last filtrate. In case the filtrate must be used for another determination, it is obvious that the filtrate should not be tested too soon. When should the filtrate be tested?

Let us assume the filter to hold 10 c.c., the solution to drain

* The reason why some precipitates require more washing than others is due to the fact that the degree of adsorption varies. (Cf. Ostwald, *Die wissenschaftl. Grundl. der analyt. Chem.*, p. 19.)

to the last drop from the paper, the amount of the solution held back by the precipitate and filter to be 1 c.c. and to contain 0.1 gm. of the solid substance which is to be removed by washing.

The filter is filled to the upper edge with wash water and allowed to drain to the last drop n times, until not more than 5/100 mgm. of the substance to be removed by washing remains.

According to our assumption, 9 c.c. drain off and 1 c.c. remains behind; we have consequently:

Removed by the		There remains after the	
1st washing,	0.1·9/10 gm.	1st washing	0.1·1/10 gm.
2d "	0.1·9/10·1/10 gm.	2d "	0.1·1/10·1/10 gm.
3d "	0.1·9/10·(1/10) ² gm.	3d "	0.1·1/10·(1/10) ² gm.
.	.	.	.
.	.	.	.
nth "	0.1·9/10·(1/10) ^{$n-1$} gm.	nth "	0.1·1/10·(1/10) ^{$n-1$} gm.

After washing n times, therefore, the amount removed by washing is the sum of the decreasing geometric series of which the first term is 0.1·9/10 and the constant factor is 1/10.

In case $n = 4$, the sum of the series is

$$\Sigma = \frac{0.1 \cdot \frac{9}{10} \left[\left(\frac{1}{10} \right)^4 - 1 \right]}{\frac{1}{10} - 1} = 0.09999 \text{ gm.}$$

After washing the precipitate four times, therefore, 0.09999 gm. of the impurity has been removed. According to the assumption that there was originally 0.1 gm. of this substance, there remains in the precipitate only 0.00001 gm., or in other words a negligible amount.

Consequently, the filtrate should be tested qualitatively for the substance to be removed only after the precipitate has been washed four times.

Often the washing will be found to have been complete after the fourth washing, but as a rule this will not be the case, and in many cases it will be found necessary to repeat the operation for from

ten to twenty times. In the processes which are described it will usually be stated how far to carry the washing.

Now with regard to the second point, how should a precipitate be washed with the least possible amount of wash water? According to the above consideration it is necessary to wash every precipitate at least four times, in which case the filter should be entirely filled each time, and it is evident that the size of the filter-paper will influence the amount of wash water used.

The filter, therefore, should be made as small as possible, irrespective as to whether there is little or much liquid to filter. *The size of the filter used should be regulated entirely by the amount of the precipitate and not at all by the amount of the liquid to be filtered.* The mistake should not be made, however, of using too small a filter. The precipitate should never reach the upper edge of the paper; about 5 mm. should remain free, and even in this case the filter should not be so completely filled as in Fig. 4, *a*.

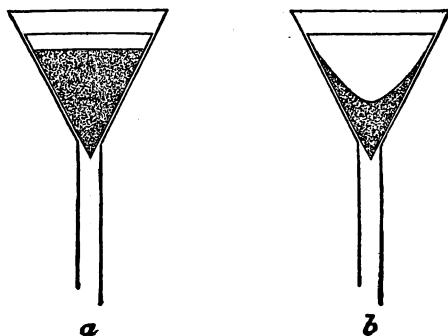

FIG. 4.

It is better to have the filter filled about as much as is shown in Fig. 4, *b*, in order that sufficient room is left for the wash water.

The use of too large filters is one of the inexcusable analytical errors.

The Drying and Igniting of Precipitates.

Before a precipitate can be weighed it must be absolutely dry. Those precipitates which do not undergo a change of weight on ignition are treated as follows:

(a) THE PRECIPITATE IS IGNITED DRY.

This method, in which the precipitate is separated from the filter, the filter burnt by itself, the ash added to the main part of the precipitate and the mixture then ignited to constant weight, is used in those cases when the ignited substance will be reduced by the burning paper, e.g., in the case of precipitates of silver chloride, lead sulphate, bismuth oxide, etc.

In order to perform this operation it is first necessary that the filter and precipitate should be completely dried at 100° C. For this purpose the funnel containing the filter is carefully covered with a piece of filter-paper,* placed in a drying-closet (preferably one that is heated by steam) and dried at 100° C. When perfectly dry, a weighed crucible is placed upon a piece of glazed paper of about 20 sq. cm. (Fig. 6, left) and the dry precipitate is carefully shaken into the crucible, removing it from the paper as completely as possible by gentle rubbing with a platinum spatula. Any small particles of the precipitate which may have fallen upon the glazed paper are brushed into the crucible with the aid of a feather (Fig. 6). Small particles of the precipitate will still always adhere to the paper and these must be weighed. In order to accomplish this, the filter is burnt and the ash obtained is either weighed by itself or mixed with the main part of the precipitate and weighed with it.†

* Wet a common cut filter, stretch it over the ground top of the funnel, and then gently tear off the superfluous paper. The cover thus formed continues to adhere after drying. Fresenius, Quant. Chem. Analysis.

† By using filter-paper which has been carefully washed with hydrochloric and hydrofluoric acids, it is permissible to neglect the weight of the ash from the filter itself. With an unknown paper it is necessary to determine the weight of the ash by a separate experiment and then correct the weight of the precipitate obtained.

The combustion of the filter, to which small particles of the precipitate still adhere, is best accomplished by the method proposed by Bunsen as follows: The filter is folded together so that the precipitate occupies the position indicated in the shaded part of Fig. 5, α , and then it is further folded as indicated by β and γ of Fig. 5 to a narrow strip. The paper is then rolled between the

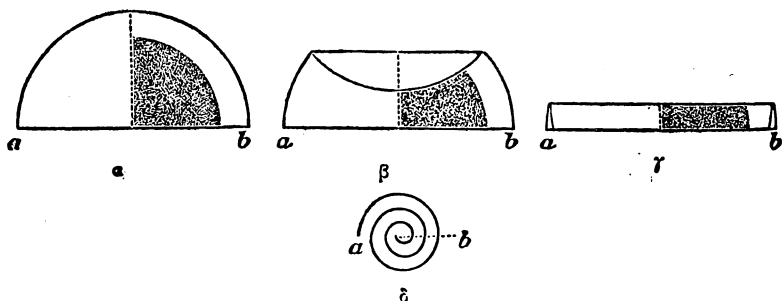

FIG. 5.

fingers as indicated by δ , beginning at b , so that the portion of the filter which is free from the precipitate is on the outside. The roll is now enveloped with a previously ignited heavy platinum wire, the wire is supported (as indicated in Fig. 6) by means of a

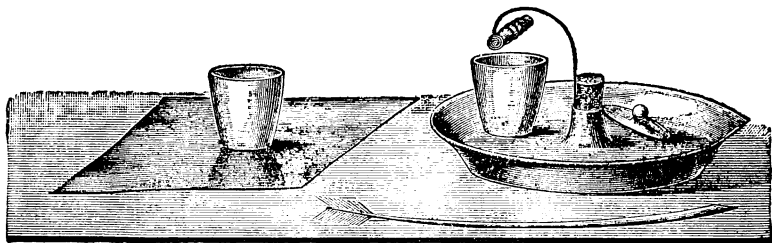

FIG. 6.

cork in the opening of a porcelain plate and the filter is ignited by means of the gas-flame. The flame is at once taken away and the paper allowed to burn quietly. If carbonized particles still remain, the gas-flame is applied repeatedly until it is no longer possible to make the particles glow any more. (Too strong ignition should be avoided.) The ash is then added to the contents of the

crucible by gentle shaking and the final use of the feather. The cover is placed on the crucible, which is heated at first with a small flame, the temperature being gradually increased until the prescribed temperature of ignition for the given precipitate is reached. The flame is finally removed, the crucible allowed to cool somewhat, and while still *warm*, but *not glowing*, is placed in a desiccator (Fig. 7).

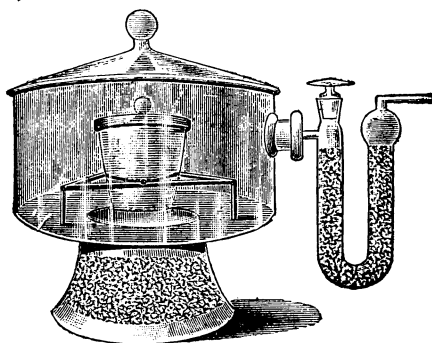

FIG. 7.

After cooling (at least three quarters of an hour for porcelain crucibles and 20 minutes for platinum ones) the crucible and its contents are weighed.

Many precipitates (silver chloride, lead sulphate, etc.) are somewhat reduced to metal by the above treatment. As, however, these metals are difficultly volatile, there will be no loss of the metal, only of the anion (chlorine in the case of silver chloride and SO_3 in the case of lead sulphate). This loss may be readily replaced. The metal in the crucible is moistened with a few drops of nitric acid to dissolve it, a few drops of hydrochloric acid (in the case of a silver chloride precipitate), or of sulphuric acid (in the case of lead sulphate) are added, and after evaporating off the excess of the acid the crucible is weighed. The only danger in this method is that in burning the filter the ash is heated too hot, so that some of the reduced metal melts and alloys with the platinum wire. If, however, the filter-paper is rolled up as was directed, there is always some paper free from precipitate between the precipitate and the platinum wire, yielding an ash which, although its weight is inappreciable, is still sufficient to protect the wire and prevent the reduced metal from coming in contact with it, provided it is not heated strongly enough to melt the metal.

Many precipitates ($\text{Mg}(\text{NH}_4)\text{AsO}_4$, K_2PtCl_6 , etc.) are changed so much by this treatment that it would be impossible to obtain correct results. In such cases the filter cannot be burnt, but it is previously dried at a definite temperature and weighed;

afterwards the precipitate and filter are again dried at the same temperature and weighed again.

In order to dry the filter, it is placed in a drying-closet* (Fig. 8a) upon a watch-glass and near an open weighing beaker, the temperature is brought to the desired point and kept there, with the help of the thermo-regulator *T*, for $\frac{1}{2}$ to 1 hour. By means of tongs the filter is quickly placed in the weighing beaker, and the latter in a desiccator filled with calcium chloride (Fig. 7), where it is kept for exactly 1 hour. It is then covered, removed from the desiccator, allowed to stand in the air near the balance for 20 minutes and then weighed. The heating and weighing is repeated once more in exactly the same way until two consecutive weighings do not differ by more than 0.0002–3 gm.

The precipitate is now collected upon the filter and after drying the filter in the funnel at 100° C. the filter and its contents are removed from the funnel and dried in exactly the same way as before.

The same result is much more simply and accurately accomplished by the use of the *Gooch Crucible*.

This consists (as is shown in Fig. 9, page 25) of a crucible with a perforated bottom. The crucible is provided with an asbestos filter, weighed after drying at the prescribed temperature, then the precipitate is filtered off into the crucible, which is again dried and weighed. The

* The drying-closet shown in Fig. 8a is fitted with six removable porcelain plates which prevent any oxide falling from the metallic closet walls upon the substance to be dried, rendering it impure. The upper plate has two holes bored in it through which thermometer and thermo-regulator are placed. This upper plate is fastened to the top of the closet as follows: A glass rod provided with a broad rim *rr* and bulging out at *aa* is pushed up through the opening *P* of the porcelain plate (Fig. 8b) and *K* of the upper closet wall, and this is fastened by placing an asbestos ring *A* between *aa* and *K*.

The bottom plate rests upon a heavy iron wire so that it does not come directly in contact with the bottom of the closet.

As the plates can be easily taken out, it is possible to clean them without difficulty. The only part of the apparatus that wears out is the bottom, so that it is best to have the closet so that it may be renewed from time to time without taking the apparatus to pieces.

Several forms of electric ovens are also in use. These require little attention and can be regulated to almost any desired temperature.

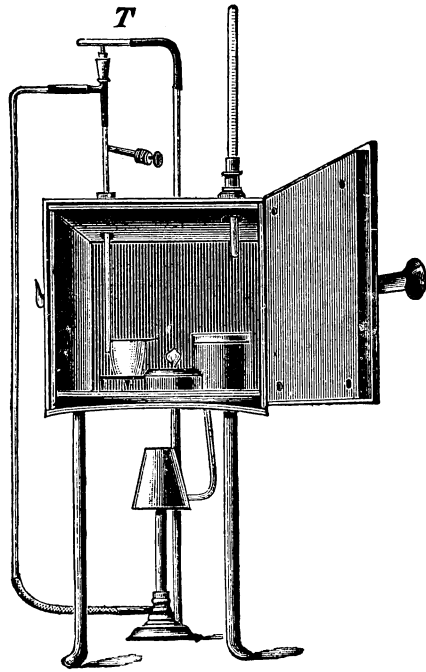

FIG. 8a.

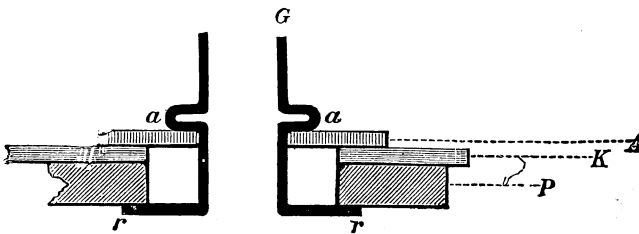

FIG. 8b.

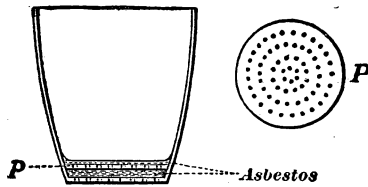

FIG. 9.

use of these crucibles permits such accurate and rapid work that it is worth while to describe the method of using them more in detail.

Preparation of Asbestos Filters.

Some long-fibred, soft asbestos is cut into pieces $\frac{1}{2}$ cm. long, and digested with concentrated hydrochloric acid upon the water bath for an hour. A good sample of asbestos will then be separated into very small fibres. The mass is collected in a funnel with a platinum cone, or upon a filter-plate, and washed with water. After drying, the asbestos may be ignited, but for most purposes this is not only unnecessary but disadvantageous.

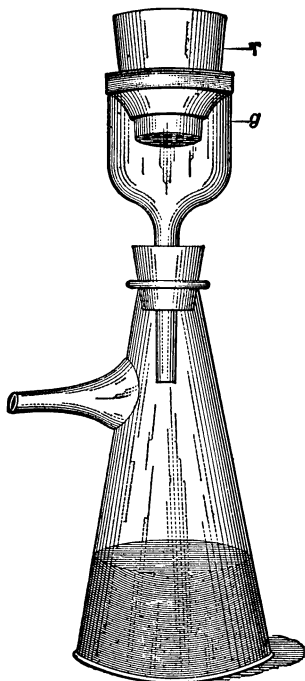

FIG. 10.

For the preparation of a Gooch filter, a small flock of the material is shaken with water in a flask, so that a thin emulsion is formed. A piece of thin rubber tubing* (Fig. 10) is stretched over a funnel and the crucible *T* is placed in the opening. The funnel should be large enough so that the crucible is suspended by the rubber without touching the sides of the funnel. Enough of the emulsion is poured through the crucible to produce a layer of 1 to 2 mm. thickness, a small filter-plate (Fig. 9, *P*) is placed upon this layer and some more of the emulsion is poured into the crucible.

Water must now be passed through the crucible until no asbestos fibres run through, and in order to see them the liquid is poured into a small beaker. Usually such a filter is prepared and used with a gentle suction,†

* In place of rubber tubing Bailey's Gooch crucible holder or Walter's Gooch crucible holder may be used to advantage.

† Too great a suction should not be employed during the filtration, for in that case the precipitate or even the asbestos itself will be so compressed that the filtration will be prolonged and the washing made more difficult.

but in many cases it filters more rapidly than paper without it.

The crucible is now dried at the proper temperature and afterwards weighed. The drying and weighing is repeated until a constant weight is obtained, when about half a liter of water is once more passed through the crucible (in order to be sure that no asbestos fibres run through) and the crucible is again dried and weighed, after which, if the weight is constant, the crucible is ready for the filtration.

The same crucible can be used for a large number of determinations. When the amount of the precipitate in the crucible becomes too large, the upper part can be carefully removed and the crucible again used.

If it is desired to ignite a precipitate contained in a Gooch crucible, it is placed (as shown in Fig. 11) within a larger porcelain crucible and heated at first gently and finally more strongly, and when necessary it can even be heated over the blast-lamp.

For many purposes it is preferable to use instead of the Gooch crucible a glass tube with an asbestos filter. This is particularly desirable when it is necessary to heat the precipitate in a gas-stream.

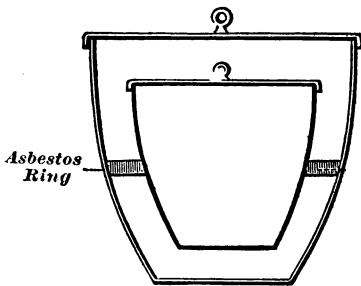

FIG. 11.

The so-called Munroe crucible,* in which the filtering medium consists of a porous felt of spongy platinum, is a modification of the Gooch crucible which permits rapid and accurate work. The felt is prepared by igniting a carefully-dried layer of ammonium chloroplatinate, which has been poured over the bottom of a platinum Gooch crucible in the form of an alcoholic sludge while

By having the crucible suspended free by the rubber, the possibility of employing too much suction is avoided, for, as soon as this has reached a certain tension the air is forced between the rubber and the sides of the crucible, so that we have the effect of a safety-valve to a certain extent.

* C. E. Munroe, *J. Anal. Chem.*, **2**, 241; *Chem. News*, **58**, 101. See also W. O. Snelling, *J. Am. Chem. Soc.*, **31**, 456, and O. D. Swett, *ibid*, **31**, 928. The last reference gives a table of suitable solvents for removing ignited precipitates from the Munroe crucible.

the crucible is held against several layers of filter paper. The felt can be shaped to the crucible during the ignition and subsequently burnished lightly with a glass rod of suitable form. In case imperfections develop, the felt should be saturated again with chloroplatinic acid, the crucible slowly lowered into a moderately concentrated solution of ammonium chloride, washed with alcohol, dried and ignited.

The use of an electric furnace, Fig. 12, is very convenient for igniting the crucible and its contents, especially in the case of

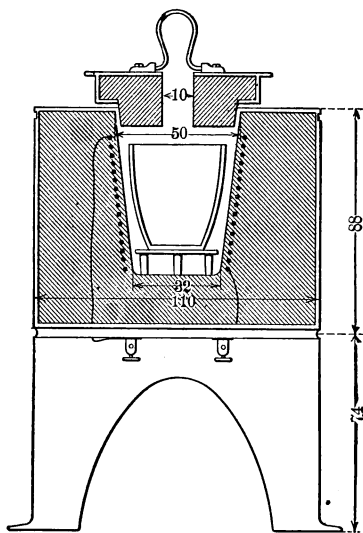

FIG. 12.

those precipitates which are likely to undergo change on coming in contact with a reducing flame.

(b) THE PRECIPITATE IS IGNITED WET.

Those precipitates which do not suffer any permanent change by the action of the products of combustion of the filter may be ignited wet. The precipitate is allowed to drain as much as possible and while still moist the filter and precipitate are placed in a platinum crucible, the paper being pressed down against the

sides of the crucible. The crucible is placed in an inclined position upon a triangle (Fig. 13),* with the cover inclined against the upper edge of the crucible and resting on the triangle. The flame of the burner is directed against the cover, which quickly dries

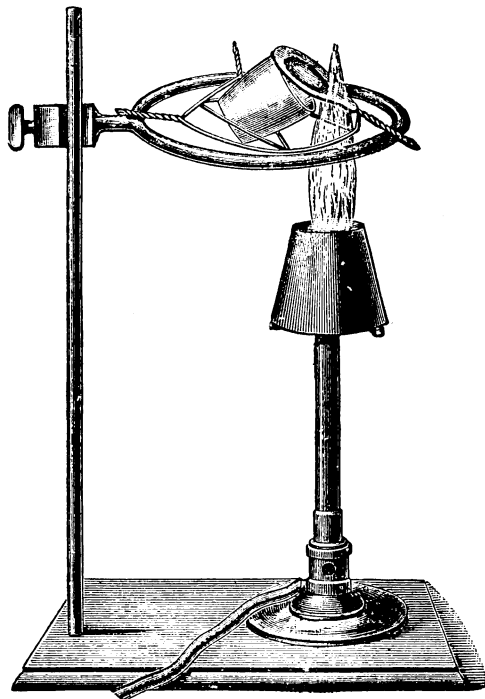

FIG. 13.

the filter, then scorches, carbonizes, and finally burns it. The flame is then slowly moved backwards under the crucible until finally the crucible is subjected to the whole heat of the burner, after which it can be heated over the blast-lamp if necessary.

* In Fig. 13, the inner triangle is platinum wire, the outer triangle is heavy iron wire. Triangles of fused silica or of nickel-chromium alloy are suitable, but platinum alloys with iron, so that a hot crucible should never be placed in contact with iron wire.

THE EVAPORATION OF LIQUIDS.

Liquids are usually evaporated upon the water-bath. In order to prevent anything from falling into the evaporating-dish it is well to cover it with an evaporation-funnel, as shown in Fig. 14.

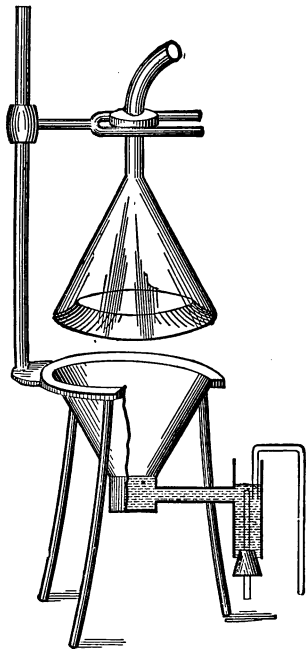

FIG. 14.

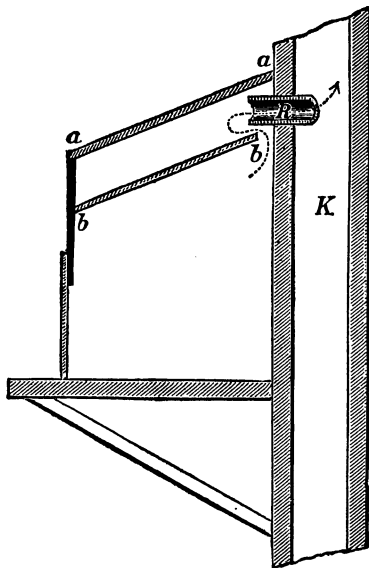

FIG. 15.

The funnel is suspended above the dish by means of a porcelain fork fastened to the iron rod (covered with hard rubber) which is attached to the water-bath.

In case the laboratory is provided with a glass-covered hood with a good draft the use of the funnel is unnecessary.

If, however, the hood is directly connected with the chimney it often happens that on a windy day a considerable amount of dust falls into the hood.

In order to prevent this, the author has made use of the following contrivance which has worked very satisfactorily for some years. The hood is provided with a glass roof, *aa*, Fig. 15, and about 15 cm. below there is a second glass plate *bb* which does not quite touch the inner wall of the hood but is about 3 cm. away from it throughout its whole length. Between the two plates there projects a clay pipe *R*, about 15 cm. in diameter and about 5 cm. above the inner edge of the lower glass plate, leading directly into the chimney *K*, in which there is a small gas-flame (not shown in the illustration). Any dust, sand, etc., from the chimney falls upon the plate *bb*; none can get into the hood.

In the evaporation of liquids on the water-bath in weighed platinum crucibles or dishes, the platinum should not come in contact with copper or glass rings. As a rule, porcelain rings should be used. In case the crucible is smaller than the ring, use is made

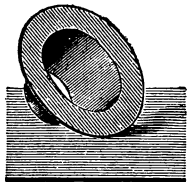

FIG. 16.

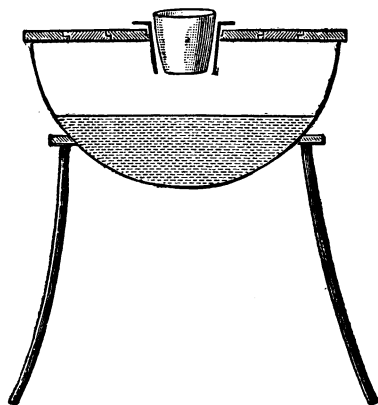

FIG. 16a.—Water-bath with porcelain ring, platinum-brass cone, and crucible.

of a truncated brass cone turned back at the base (Fig. 16), and lined with thin platinum foil. This is suspended in the ring and the crucible placed within the cone (Fig. 16a).

During evaporation many substances have the property of "creeping" over the edge of the crucible or dish, often causing a slight loss of the substance; furthermore there is often "bump-

ing," so that in some cases the entire contents are thrown out of the crucible (cf. the determination of boric acid according to the method of Gooch). Both of these phenomena can be readily prevented as follows:

The crucible, at the most not more than two-thirds filled with liquid, is placed in the cylindrical tin or brass spiral *kk* (Fig. 17).

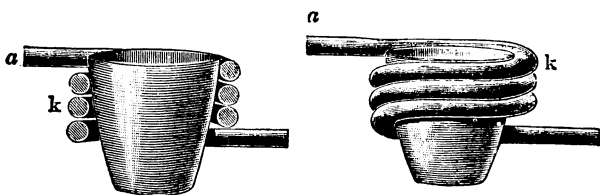

FIG. 17.

The first two windings of the metallic spiral come into close contact with the sides of the crucible *above the liquid*, while the remaining windings should not touch the crucible. When steam is passed through the spiral the upper part of the crucible is warmed first, so that there is no spattering, and furthermore by keeping the upper edge hot during the whole of the evaporation all "creeping" of the substance is avoided. In this way it is possible to evaporate off alcohol rapidly without boiling the liquid.

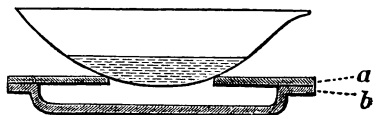

FIG. 18.

a = asbestos ring.
b = asbestos plate.

In case it is desired to evaporate high-boiling liquids, such as sulphuric acid, amyl alcohol, etc., the crucible is either heated cautiously over the free flame (continually moving it back and forth) or else the crucible is placed in an air-bath, which can be prepared in some such way as is represented by Fig. 18.

Drying Substances in Currents of Gases.

Substances may be dried at a high temperature in a current of air or of carbonic acid in a number of different ways. An oil-bath provided with a number of copper tubes (Fig. 19) may be used. The substance contained in a small "boat" is placed in a glass tube and the latter in one of the copper tubes. The gas is now passed through one or more of the empty tubes (so as to warm it), and then through the tube containing the substance.

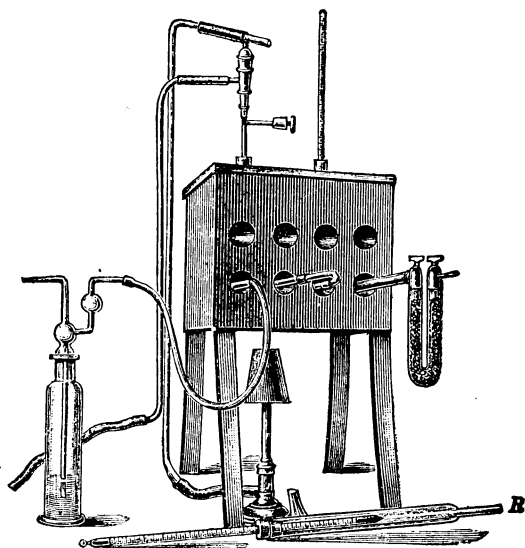

FIG. 19.

R = tube with thermometer for measuring the temperature of the gas-stream.

In order to heat a crucible in a current of carbon dioxide, use can be made of Paul's drying oven (Fig. 20). The crucible is placed in the glass pipe *R* and the pipe and copper cylinder *K* are covered with watch-glasses. Dry carbon dioxide is conducted through the stem of the pipe, and the oven can be heated to any desired temperature.

In case it is desired to evaporate off a liquid in a flask and to

ignite the residue at a given temperature it is necessary to proceed somewhat as follows;

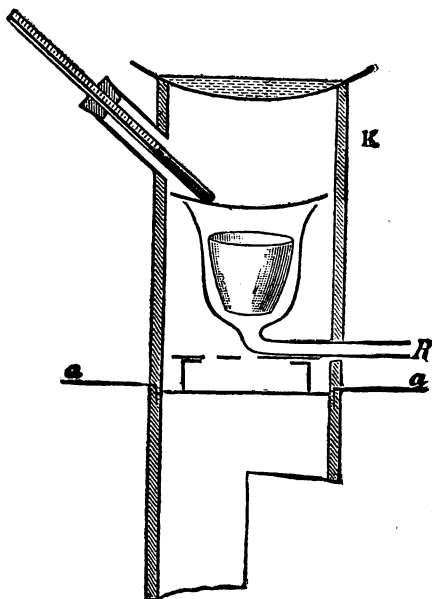

FIG. 20.

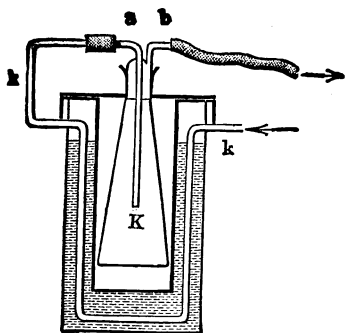

FIG. 21a.

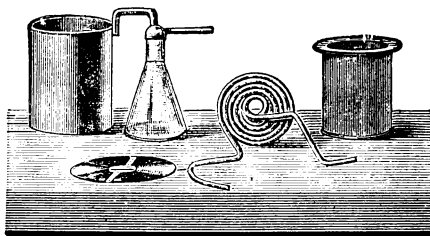

FIG. 21b.

The solution is placed in the open Erlenmeyer flask *K* and evaporated as far as possible over the free flame. The flask is

then placed in a metal beaker suspended in an oil-bath (Fig. 21a), and dry air is sucked through the spiral copper tube *kk* as shown in the illustration. Fig. 21b shows the separate parts of the apparatus.

PREPARATION OF THE SUBSTANCE FOR ANALYSIS.

It is very difficult to give general rules for the preparation of substances for analysis, for it is necessary to proceed differently in different cases. For a scientific analysis (i.e., one in which it is desired to determine the atomic composition of a substance) it is necessary to choose pure material for the analysis. Although this sounds so simple it is often one of the most difficult conditions to fulfil. Many substances are hygroscopic and absorb moisture from the air, which can be removed by heating the substance or by simply allowing it to stand in a desiccator over calcium chloride, provided the substance itself undergoes no change by this treatment. Many substances containing water of crystallization cannot even be dried in a desiccator, but must be analyzed air-dry. In all cases it is necessary to determine whether the substance to be analyzed possesses a constant weight.

For *technical analyses*, the purpose being to determine the cost or selling price of an article or to control its manufacture, the substance must be analyzed *as it is*. In such a case the sample should represent as far as possible the average composition of the product.

For our work we are concerned chiefly with scientific analyses and the first substances to be analyzed are easily crystallized from water.

Many commercial salts are prepared extremely pure and could be analyzed directly; in most cases, however, we obtain them after they have stood for some time in the air and after they have been handled somewhat, so that they are not so pure as when freshly prepared. Consequently in case it is desired to test the accuracy of an analytical process, the purity of a commercial sample should never be taken for granted. The substance should be purified by

Recrystallization.

Ten or fifteen grams of the commercial salt are dissolved in the least possible amount of hot water (it is best to use not quite

enough water to completely dissolve the substance) and the hot solution is rapidly poured through a plaited filter contained in a funnel the stem of which has been broken off (Fig. 22). This serves to remove all dust or other insoluble impurity. The filtrate is received with constant stirring in an evaporating-dish and is rapidly cooled by placing the dish in a larger one containing cold water.



FIG. 22.

By means of the rapid cooling and constant stirring, the salt is obtained in the form of a crystalline powder,* which is filtered off by pouring through a funnel provided with a perforated platinum cone. The mother-liquor is removed as much as possible by means of suction. The purity of the substance is then tested qualitatively by means of some suitable reaction. In case it is still not quite pure, the same process of recrystallization must be repeated until the presence of no impurity can be detected.

The pure but still moist substance is placed upon a layer of several thicknesses of clean filter-paper, covered with another sheet of the same and allowed to stand for twelve hours at the ordinary temperature. One or two grams of the substance are then weighed upon a tared watch-glass, placed upon a dry glass plate, covered with another watch-glass and allowed to stand for several hours more. If the substance shows no change in weight it is ready for

* Large crystals would be obtained by allowing the solution to cool slowly, but they are not desirable, as they usually contain more enclosed mother-liquor than do the smaller crystals.

analysis. Otherwise it must be dried in the air until it no longer shows a change in weight. It is not permissible to dry the substance in a desiccator except in those cases in which the substance will not lose water of crystallization. Deliquescent substances of course should not be allowed to remain exposed to the air for very long. Such substances must be quickly dried upon a porous plate and transferred as soon as possible to a flask provided with a closely fitting ground-glass stopper. Further rules for the preparation of the substance for analysis will be given under the special cases.

PART I.

GRAVIMETRIC ANALYSIS.

A. GRAVIMETRIC DETERMINATION OF THE METALS (CATIONS).

METALS OF GROUP V.

POTASSIUM, SODIUM, LITHIUM, AMMONIUM, AND MAGNESIUM

POTASSIUM, K. At. Wt. 39.10.

Forms: * KCl, K_2SO_4 , K_2PtCl_6 , and $KClO_4$.

I. The Determination as Chloride.

THIS compound is chosen for the determination of potassium when it is already present as such, or in case the salt to be analyzed may be changed to the chloride by evaporation with hydrochloric acid. If the potassium is present in the form of its sulphate it may be transformed to the chloride by precipitation with barium chloride (see silicate analysis); if it is present as the phosphate, the phosphoric acid may be precipitated as basic ferric phosphate (Vol. I, p. 337, Ed. IV); or, finally, if it is present as chromate the CrO_4^- ions may be reduced to chromic ions by evaporation with hydrochloric acid and alcohol and then precipitated by ammonia and filtered off.

In almost all of these cases it is a question of separating the potassium chloride from the aqueous solution and in most cases of separating it from ammonium chloride as well.

First of all the solution is evaporated to dryness on the water-bath in a platinum dish (or if necessary a thin *porcelain* dish may

* Under this heading will be given in every case the symbols of the compounds suitable for the determination of the element in question.

be substituted), taking the precaution of stirring the liquid frequently with a heavy platinum wire, as soon as the salt begins to separate out, in order to hasten the evaporation of the enclosed water. In spite of long-continued heating and continual stirring, however, it is not possible to completely expel all of the water enclosed within the crystals; this is effected by covering the dish with a watch-glass and drying in the hot closet for an hour or two at 130° – 150° C. The covered dish is then placed upon a platinum triangle and cautiously heated over a free flame, holding the burner in the hand and imparting to it a fanning motion. The dish is kept covered as long as a decrepitating sound can be heard. The cover is then taken off, any ammonium chloride on it is removed by careful heating, and it is then placed upon another clean watch-glass. The dish is then heated again over the constantly moving flame until the vapors of ammonium chloride cease to be given off, care being taken not to heat the potassium chloride too strongly on account of its volatility. Any potassium chloride remaining on the cover is then washed into the dish by means of a little water, the salt in the dish is brought into solution by rotating this water in the dish and the almost ever-present carbon particles (from the carbonization of pyridine bases usually present to a slight extent in the ammonia and ammonium chloride) are filtered off through a small filter into a weighed platinum crucible. A few drops of HCl are added, the contents of the crucible evaporated to dryness on the water-bath, again covered and allowed to remain in the drying-closet for one to two hours at 130° – 150° C. and once more heated over the free flame until all decrepitation has ceased, when the crucible is allowed to cool in a desiccator and is weighed. After this the crucible is again heated for a few moments over the free flame so that the bottom of the crucible becomes a dark red (the cover of the crucible must not be lifted during this operation); it is allowed to cool, and is again weighed. The process is repeated until a constant weight is obtained.

In the case of every analytical operation the heating and weighing must always be repeated until two consecutive weights are the same. Therefore, whenever the terms "heated" (or "ignited") and "weighed" are used in this book, it is to be always understood that a constant weight is to be obtained.

This method is capable of yielding exact results.

Example: Determination of Potassium in Potassium Bichromate.

—Commercial potassium bichromate usually contains potassium sulphate as impurity. The salt is therefore purified, as described on p. 35, by recrystallizing three times from water, placing the moist crystals in an evaporating-dish, heating on the water-bath with constant stirring and finally drying to constant weight in an oil-bath at 130° C. (cf. p. 33) in a current of dry air.

The dry substance is then weighed upon a tared watch-glass, placed in a 300-c.c. porcelain evaporating-dish, treated with 10 c.c. of concentrated HCl and 5 c.c. of alcohol, covered with a watch-glass and warmed upon the water-bath until the solution becomes a pure emerald-green. Any solution which may have spattered up on the cover-glass is washed into the dish by means of a stream of water from the wash-bottle and the solution is then evaporated to dryness. About 2 c.c. of concentrated HCl and 200 c.c. of water are now added, the liquid is heated to boiling and precipitated with the least possible excess of ammonia, filtered and washed with hot water until 1 c.c. of the filtrate evaporated upon the cover of a platinum crucible leaves no residue. If, however, on making this test a residue remains, it must be redissolved in water and added to the rest of the filtrate. After the washing is found to be complete, the filtrate is evaporated to dryness as previously described,* the ammonium chloride expelled, and the residue of potassium chloride is weighed.

If a is the amount of potassium bichromate taken, and p the weight of potassium chloride obtained, the amount of potassium present in the potassium bichromate may be calculated as follows:

$$\begin{aligned} \text{KCl:K} &= p:s \\ 74.56:39.10 &= p:s \end{aligned}$$

$s = \frac{39.10}{74.56} p$ = weight of potassium in a gm. of bichromate and in percentage

$$x = \frac{100 \times 39.10}{74.56} \cdot \frac{p}{a} = \text{per cent. K.}$$

* Frequently a little Cr(OH)_3 separates out during the evaporation; it must be filtered off and washed free from the solution.

It is customary to carry out the analysis in duplicate and to be satisfied only when two closely agreeing results are obtained, of which the mean is taken as the true value. According to the above method results are obtained which are slightly lower than the theoretical value, but this should not amount to more than 0.15 per cent. and the two "check" determinations should not differ by more than 0.1 per cent. from one another.

2. Determination of Potassium as Potassium Sulphate.

This method is chosen when the potassium is already present in solution as the sulphate, or when it is in such a form that it can be readily changed to sulphate by evaporation with sulphuric acid; it is most frequently used for determining the amount of potassium in combination with organic acids.

Since the sulphate of potassium is much less volatile than the chloride, it is advisable to choose this method in case no other metal is present. On the other hand, when it is necessary to separate potassium from sodium, it is preferable to have the potassium in the form of the chloride.

Example: Determination of Potassium in Potassium Bichromate.—About 0.5 gm. of the purified and dried salt is weighed, as described under 1, into a 300-c.c. porcelain evaporating-dish, treated with 20 c.c. of a freshly prepared, saturated, aqueous solution of sulphur dioxide* and 5 c.c. of double-normal sulphuric acid. The dish is covered with a watch-glass and warmed on the water-bath until there is no further evolution of gas perceptible, when the cover-glass is rinsed off, removed and the solution evaporated almost to dryness. About 200 c.c. of water are now added and the chromium is precipitated from the boiling solution by means of the slightest possible excess of ammonia. The precipitate is filtered off and washed

* The solution of sulphur dioxide may be prepared as follows: Into a 300-c.c. Erlenmeyer flask about 150 c.c. of a saturated sodium bisulphite solution are placed, and concentrated sulphuric acid is slowly added from a drop-funnel, causing a lively evolution of SO_2 gas. This gas is passed first into a small wash-bottle containing water and then into another flask of distilled water, which is kept cool by placing it in a larger vessel filled with cold water. When the evolution of the SO_2 begins to slacken, it can be accelerated by gentle warming.

until it can be shown by the test applied under 1 that it is completely free from the solution. The filtrate, containing both potassium and ammonium salts, is evaporated in a platinum dish to dryness, the ammonium sulphate is removed by gentle ignition (the salt melts and gases are evolved), the residue is dissolved in as little water as possible and transferred to a weighed platinum crucible. After being evaporated on the water-bath to dryness the bottom of the crucible is heated by means of a free flame to dull redness until SO_3 vapors cease to come off. The crucible is allowed to cool in a desiccator and then weighed. A piece of ammonium carbonate the size of a pea is placed in the crucible (see below), which is again heated and weighed, the process being repeated until a constant weight is obtained.

If a is the weight of substance taken and p the weight of the K_2SO_4 obtained, then the percentage of potassium in the potassium bichromate may be calculated as follows:

$$\text{K}_2\text{SO}_4 : \text{K}_2 = p : s$$

$$174.27 : 78.20 = p : s$$

$$s = \frac{78.20}{174.27} p$$

$$a : \frac{78.20}{174.27} p = 100 : x$$

and
$$x = \frac{100 \times 78.20}{174.27} \cdot \frac{p}{a} = \text{per cent. K.}$$

In order to determine the amount of potassium in organic salts, a weighed sample is placed in a large platinum crucible, moistened with a little concentrated sulphuric acid, and heated over the free flame exactly as in the case of igniting a moist precipitate (p. 29), placing the crucible in an inclined position and directing the flame against the cover of the crucible. Thick, white fumes of sulphuric acid are soon evolved; as soon as these begin to diminish in quantity the flame is gradually brought toward the base of the crucible, finally heating it to a dull red until no more vapors are given off. The mass remaining in the crucible now consists of K_2SO_4 and $\text{K}_2\text{S}_2\text{O}_7$. The latter compound can be converted by stronger ignition into K_2SO_4 with loss of SO_3 , but as this procedure involves a slight loss of potassium it is preferable to add a little solid ammonium carbonate, by means of which the excess of sul-

phuric acid is converted into ammonium sulphate, which is readily volatile and can be driven off at a much lower temperature.

3. Determination of Potassium as K_2PtCl_6 and as $KClO_4$.

These determinations are only employed when it is necessary to effect a separation of potassium from sodium. We will, therefore, first consider the determination of sodium itself and afterwards the separation of the two metals.

SODIUM, Na. At. Wt. 23.00.

Sodium, like potassium, is determined in the form of its chloride and of its sulphate, and the same precautions which were discussed under potassium hold in the case of sodium. It may be mentioned, however, that $NaCl$ and Na_2SO_4 are more difficultly fusible and much less volatile than the corresponding potassium compounds.

Separation of Potassium from Sodium.

The solution should contain salts of no other metals with the exception of ammonium salts. In order to separate the sodium and potassium they should both be present as chlorides, the combined weight of which being first ascertained. The mixture is then dissolved and the potassium precipitated out either as chloroplatinate or as perchlorate. From the weight of the precipitate, the corresponding amount of potassium chloride can be calculated, which value is deducted from the weight of the combined chlorides; this gives the weight of sodium chloride originally present. The sodium, therefore, is determined by difference.

A. Separation of the Potassium as K_2PtCl_6 .

Principle.— K_2PtCl_6 is practically insoluble in absolute alcohol, whereas the corresponding sodium salt is soluble. On the other hand, sodium chloride is insoluble in absolute alcohol, so that it is absolutely necessary to convert both the potassium and the sodium to the form of their chloroplatinates, as otherwise the K_2PtCl_6 obtained will be contaminated with sodium chloride and too high a value will be found for the amount of potassium present.

Procedure: 1. *Transformation of the Chlorides into Chloroplati-*

notes.—The assumption made is that the weight of the two chlorides p consisted entirely of sodium chloride, and from this the amount of chloroplatinic acid necessary to convert the chloride into chloroplatinate can be calculated:

$$2\text{NaCl}:\text{Pt} = p:x$$

$$x = \frac{\text{Pt}}{2\text{NaCl}} \cdot p = \text{weight of Pt in H}_2\text{PtCl}_6 \text{ required.}$$

Since the reagent (cf. Vol. I) contains 10 per cent. Pt, we may say that 10 c.c. contain 1 gram of platinum and p grams of sodium chloride require

$$\frac{\text{Pt} \cdot 10}{2\text{NaCl}} \cdot p \text{ c.c. of H}_2\text{PtCl}_6.$$

The solution of the two chlorides in water (contained in a platinum or porcelain evaporating-dish) is treated with a few tenths more than the calculated number of cubic centimeters of H_2PtCl_6 and is then evaporated almost to dryness on the water-bath at as low a temperature as possible (the water should not boil). After cooling, the residue is treated with a few c.c. of absolute alcohol (best methyl alcohol *), after which the solid mass is broken up into a fine powder by means of a stirring-rod or a platinum spatula. The liquid is then decanted through a filter moistened with alcohol, and the treatment of the residue with alcohol together with the breaking up into powder, etc., is repeated until the alcohol runs through the filter completely colorless and the salt remaining assumes a pure, gold-yellow color without any orange-colored particles being present ($\text{Na}_2\text{PtCl}_6 + 6\text{H}_2\text{O}$). The precipitate is then **carefully** transferred to the filter, the alcohol is allowed to completely drain off, and the precipitate is dried in the hot closet at 80° – 90° C. The greater part of the precipitate is then placed upon a clean watch-glass, the filter is replaced in the funnel, and the precipitate which still adheres to it (and likewise any precipitate adhering to the dish in which the original precipitation took place) is dissolved off by means of a little hot water into a weighed platinum dish or crucible. The precipitate is evaporated

* Dupré, Inaugural Dissertation, Halle, 1893.

to dryness on the water-bath at as low a temperature as possible, and to it is now added the precipitate from the watch-glass. It is dried at 160° C. and weighed. The calculation of the amount of potassium chloride corresponding to the weight of the precipitate is performed as follows:

The weight p of the potassium chloroplatinate is multiplied by 0.3056 and this gives at once the weight of the potassium chloride.

Remark.—The coefficient 0.3056 is used instead of the true factor (0.3068), because the potassium chloroplatinate precipitate does not exactly correspond to the formula K_2PtCl_6 .* It contains, in fact, a little more chlorine, besides oxygen and hydrogen, which are not given off as water at a temperature of 160° C. We must assume that the chloroplatinic acid is decomposed slightly on evaporation, perhaps according to the following equation:

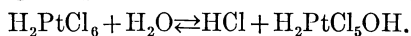

By this hydrolysis a mixture of the potassium salts ($K_2PtCl_6 + KHPtCl_5OH$) is obtained, but fortunately if the work is always done in the same way these compounds are always formed in the same relative amounts. Innumerable determinations have shown that correct results are obtained if the factor 0.3056 is used in the calculations.

Modification of Chloroplatinate Method.

Instead of weighing the K_2PtCl_6 , the dry precipitate may be heated in a stream of hydrogen, when HCl and H_2O will be given off and a mixture of platinum and potassium chloride will remain behind.

1. If the amount of hydrochloric acid evolved is determined (p gm.) and from this the calculation of the potassium chloride made according to the following equation,

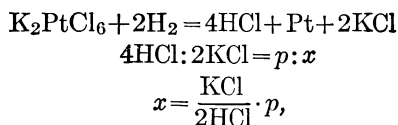

* Cf. Fresenius, Z. anal. Chem., 1882, p. 234. Also F. Dupré, "Die Bestimmung der Kaliums als Kaliumplatinchlorid," Inaugural Dissert., Halle, 1893. Also W. Dittmar and McArthur, J. Soc. Chem., Ind. 6, 799, and Ber., 1888, Ref. 412.

the result will be too low because less HCl is evolved than corresponds to the above equation.

2. If the mixture of platinum and potassium chloride remaining in the dish is weighed (p gm.) and the amount of potassium chloride is calculated according to the equation

$$\begin{aligned} (\text{Pt} + 2\text{KCl}) : 2\text{KCl} &= p : x \\ x &= \frac{2\text{KCl}}{\text{Pt} + 2\text{KCl}} \cdot p \end{aligned}$$

too low a result will be obtained.

3. Finally, if the mixture of platinum and potassium chloride is treated with water and, on the one hand, the weight of the platinum remaining undissolved and, on the other hand, the weight of the potassium chloride which goes into solution (by evaporating the solution and weighing the residue) is determined, then the amount of potassium chloride calculated from the weight p of the platinum

$$\begin{aligned} \text{Pt} : 2\text{KCl} &= p : x \\ x &= \frac{2\text{KCl}}{\text{Pt}} \cdot p \end{aligned}$$

again gives a result which is too low; while the amount of potassium chloride found in the aqueous solution corresponds to the amount of potassium chloride originally present.

Inasmuch as the precipitate of potassium chloroplatinate possesses a constant composition it is possible to determine experimentally by working with pure materials the exact ratio which exists between (a) the amount of hydrochloric acid evolved, (b) the mixture of potassium chloride and of platinum remaining after the ignition, (c) the weight of platinum remaining undissolved after treatment of the residue with water and the amount of potassium chloride originally present. According to Dupré, if the amount of platinum determined according to 3 is multiplied by the factor 0.76142 the true amount of potassium chloride will be obtained.

As an example of the modified chloroplatinate method we have the

Neubauer-Finkener Method.*

This method does not require that the sodium and potassium shall be present as chlorides. It depends upon the precipitation of potassium chloroplatinate in the presence of ether-alcohol, igniting the precipitate (K_2PtCl_6 , Na_2SO_4 , etc.) in hydrogen, washing out the soluble salts, and weighing the residual platinum.

Procedure.—The solution containing about 0.5 gm. of substance is poured into a large porcelain casserole and treated with a few drops of hydrochloric acid. Somewhat more than enough chloroplatinic acid to precipitate the potassium is added, and the solution evaporated on the water-bath until its volume does not appear to diminish perceptibly; an unnecessarily long heating is to be avoided. After cooling the mass is moistened with about 1 c.c. of water and carefully crushed with the end of a flattened stirring-rod; then at least 30 c.c. of alcohol (93–96 per cent. by volume) are added in portions of 10 c.c., each time crushing the mass with the rod. If considerable sodium or potassium is present, the mass toward the end assumes a soft, cheesy consistency but eventually becomes hard and crystalline. The covered casserole is next allowed to stand for half an hour, rubbing the precipitate from time to time. Then the supernatant liquid is poured through a platinum Gooch crucible and the precipitate washed by decantation with alcohol. After each addition of alcohol the crystals are forcibly crushed with the rod. As soon as the filtrate passes colorless through the filter the precipitate is transferred to the crucible with alcohol, the alcohol is removed by washing six times with ether, and the latter by sucking air rapidly through the crucible. The crucible is covered, and through an opening in the cover hydrogen (or illuminating-gas)† is passed and the crucible is heated, at first very gently, to avoid losses by decrepitation. After five

* Z. anal. Chem., 1900, 485.

† As in the determination of copper as cuprous sulphide, cf. p. 183.

minutes the flame of the burner is turned a little higher so that the bottom of the crucible just shows a faint redness in the center,* and this temperature is maintained for at least twenty minutes. It is then allowed to cool. The contents are next moistened with cold water, and hot water is sucked through the crucible fifteen times to remove the soluble salts completely. To remove calcium sulphate, or other difficultly soluble salts, the crucible is filled with 5 per cent. nitric acid (not HCl), which is allowed to act for about half an hour, from time to time replacing with a little fresh acid. Then wash with hot water, dry and weigh the platinum from which the corresponding amount of KCl is obtained by multiplying by 0.7612,† or of K₂O by using the factor 0.4811.

If hydrochloric acid were used instead of nitric acid in the above treatment, the platinum would subsequently run through the filter in a colloidal condition.‡

* The crucible should be placed upon a piece of platinum foil so that the flame does not come directly in contact with the perforation in the bottom of the Gooch crucible.

† According to Neubauer the coefficient 0.7612 must be used in the presence of sulphates, and Dupré found that the factor 0.7614 holds in the case of chlorides. Similarly, Dittmar and McArthur (*Z. anal. Chem.*, **28**, 767) state that the factor 0.7611 applies in the presence of much magnesium.

‡ Kling and Engels, *Z. anal. Chem.*, **45**, 315 (1906).

Determination of Small Amounts of Potassium in the Presence of Considerable Sodium.

The solution may contain sodium, potassium, calcium, and magnesium in the form of their chlorides or sulphates, etc. Hydrochloric acid gas is conducted into the solution, which has been concentrated as much as possible, until it has become saturated with the gas (the lower end of the delivery-tube should be enlarged, as indicated in Fig. 23, and should not dip into the liquid). To every 100 c.c. of the solution 2 c.c. of water are now added, the precipitated sodium chloride is allowed to settle and the solution poured through a funnel provided with a platinum filter-cone. The precipitated salt is washed three times by decantation with 95 per cent alcohol, transferred to the funnel, dried by suction and then washed three times more with alcohol.

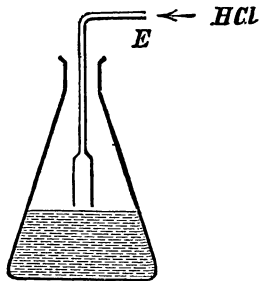

FIG. 23.

The precipitated salt is washed three times by decantation with 95 per cent alcohol, transferred to the funnel, dried by suction and then washed three times more with alcohol.

In the solution there remains all of the potassium, some sodium, and possibly calcium, magnesium, and sulphuric acid.

The solution is evaporated to dryness on the water-bath if possible (or if sulphuric acid is present the last traces of the free acid are removed by means of the free flame), the residue is weighed, for every decigram of the salt mixture 3 c.c. of double-normal hydrochloric acid are added with more than enough chloroplatinic acid to precipitate all of the potassium, and the liquid is evaporated to a paste. It is then treated with 20 c.c. of absolute alcohol, and well stirred. After standing five minutes 5 c.c. of ether are added, the mixture is allowed to stand half an hour under a bell-jar, and then filtered. As the residue often contains small amounts of other chloroplatinates, it should be purified as follows: The precipitate is allowed to dry in the air, it is dissolved in a little hot water, a few drops of chloroplatinic acid are added, and the above operation is repeated. The precipitate thus obtained contains all of the potassium in the presence of some sodium chloride and possibly sodium sulphate. It is washed with a mixture of ether and alcohol until the liquid runs through

the filter completely colorless, after which the precipitate is dried, moistened with hot water, and digested on the water-bath with a few drops of chemically pure mercury,* constantly stirring with a glass rod, until the liquid appears perfectly colorless.

By means of this treatment the potassium chloroplatinate is completely decomposed with separation of platinum:

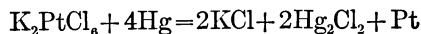

The mixture is thoroughly dried on the water-bath and gently ignited until the mercury is all volatilized; the platinum is changed at the same time to a denser form, which can be readily washed by decantation. After cooling, the mass is treated with water, the aqueous solution is decanted through a filter, and the residual metal is washed with hot water, dried, and cautiously ignited. The filter is ignited in a platinum spiral, its ash is added to the main portion of the platinum in the crucible which is now ignited, and weighed. The weight obtained p multiplied by 0.7612, gives the amount of potassium chloride, or multiplied by 0.3994, gives the corresponding amount of potassium.

Separation of Potassium from Sodium by the Perchlorate Method. Schlössing-Wense.†

Principle.—This separation depends upon the insolubility of potassium perchlorate and the solubility of sodium perchlorate in 97 per cent alcohol. Ammonium salts and sulphates must not be present on account of the difficult solubility of ammonium salts and of sodium sulphate in alcohol, but a little phosphate does no harm, as both sodium perchlorate and phosphoric acid are soluble in alcohol.

Procedure.—If the solution to be analyzed contains sulphate, it is acidified with 10 c.c. of 12N·HCl, heated to boiling and treated drop by drop with boiling 0.5N·BaCl₂ solution until no more precipitate is formed. The solution is boiled gently for

* Sonnstädt, Z. anal. Chem., **36**, 501.

† Z. angew. Chem., **4**, 691; **5**, 233; **6**, 68; Landw. Ver. Sta., **59**, 313; **67**, 145; J. Am. Chem. Soc., **36**, 2085. The reagent costs only about one-hundredth as much as an equivalent quantity of chloroplatinic acid and the results obtained are nearly as reliable.

fifteen minutes and is then filtered. This treatment is unnecessary when only a trace of SO_4^{2-} is present, and in all cases an excess of BaCl_2 should be avoided.

The solution is next evaporated to dryness in platinum and any NH_4 salt is expelled by careful ignition.*

The residue is dissolved in 20 c.c. of hot water and a little more than enough HClO_4 to combine with all the bases present is added. One c.c. of 20 per cent HClO_4 is enough for 90 mg. K. The solution is evaporated to dryness, the residue dissolved in 10 c.c. of hot water, a little more HClO_4 is added and the evaporation to dryness is repeated. If white fumes of HClO_4 do not appear, the addition of water and HClO_4 is repeated until finally heavy fumes of HClO_4 are obtained on evaporation. After cooling, the residue is treated with about 20 c.c. of 0.2 per cent HClO_4 in 97 per cent alcohol. It is best to break up the crystals somewhat, but care should be taken not to reduce them to a fine powder which will subsequently pass through the filter. The solution is decanted through a Gooch crucible, which has been washed with the 0.2 per cent solution of HClO_4 in alcohol, dried at 130° , and weighed. If there is an unusually large precipitate of KClO_4 , it should be dissolved in a little hot water and the solution again evaporated with a little HClO_4 . Finally the precipitate is washed once by decantation with 0.2 per cent HClO_4 in alcohol and then several times on the asbestos felt. The small quantity of HClO_4 remaining will be volatilized during the drying. Finally the crucible and its contents are dried at 130° for an hour and weighed.

Care should be taken not to evaporate HClO_4 and alcohol together over a free flame, as a dangerous explosion is likely to result. There is no danger in evaporating an aqueous solution of perchloric acid.

Preparation of Perchloric Acid According to Kreider.†—About 100–300 gms. of commercial NaClO_3 are placed in a round-bottomed flask and gradually heated until oxygen begins to be evolved slowly. This temperature is maintained until the

* Cf. p. 498, foot-note.

† Z. anorg. Chem. IX, 342.

mass becomes solid (requiring $1\frac{1}{2}$ -2 hours), whereby the chlorate is almost completely changed to perchlorate and chloride.

After cooling, the melt is dissolved in water, sufficient hydrochloric acid is added to decompose any chlorate remaining, and the solution is evaporated to dryness (the liquid being constantly stirred from the time crystals begin to separate out.)

The dry mass is broken up with a stirring-rod and then treated in a tall beaker with an excess of concentrated hydrochloric acid, by means of which sodium chloride separates out after a few minutes. The solution (it now contains perchloric and hydrochloric acids in the presence of small amounts of sodium chloride) is poured through a Gooch crucible and the residue is washed once or twice by decantation with concentrated hydrochloric acid. The filtrate is evaporated on the water-bath until the hydrochloric acid is completely expelled and heavy white fumes of perchloric acid are evolved.

Inasmuch as commercial sodium chlorate is often impure, it is necessary to test the perchloric acid, which has been prepared, for potassium. For this purpose a small amount of the solution is evaporated on the water-bath to dryness and the residue is treated with 97 per cent. alcohol, which will dissolve it readily in the absence of potassium perchlorate. If potassium is found to be present, the melt obtained by heating the sodium chlorate as above described is treated with HCl and evaporated to dryness in order to decompose any sodium chlorate remaining. The residue is finely powdered and treated with 97 per cent. alcohol (1 c.c. dissolves 0.2 gm. NaClO_3) and filtered, and the process repeated until a little of the alcoholic solution when evaporated to dryness leaves absolutely no residue.

The alcoholic solution, which is now free from potassium, is distilled from a spacious flask until the perchlorate begins to crystallize out, when it is poured rapidly into an evaporating-dish, evaporated to dryness, and treated as previously described, with hydrochloric acid, etc.

One c.c. of a perchloric acid solution prepared according to the above directions gave a residue of 0.0369 gm. which was completely soluble in 97 per cent. alcohol, as it should be.

In order to ascertain the approximate amount of perchloric

acid contained in the solution, 1 c.c. should be treated with an excess of KCl, evaporated to dryness, treated with an excess of 97 per cent. alcohol, filtered through a Gooch crucible, and washed until the filtrate shows no turbidity on being treated with silver nitrate solution. The precipitate is then dried and weighed.

LITHIUM, Li. At. Wt. 6.94.

Forms: Li_2SO_4 and LiCl .

The determination of lithium in the form of the above salts is carried out in practically the same way as in the case of potassium. It should be mentioned, however, that on evaporating a lithium salt with concentrated sulphuric acid the acid salt, LiHSO_4 , is formed, which on gentle ignition (even without the addition of ammonium carbonate) is changed to difficultly volatile Li_2SO_4 .

Since lithium chloride is a very hygroscopic salt, it is necessary to weigh it out of contact with moist air. To accomplish this, the platinum crucible, after being gently ignited, is placed in a desiccator which is provided with a calcium-chloride tube, and beside the crucible is placed a weighing beaker with ground glass stopper. After both crucible and beaker have assumed the temperature of the room, the former is quickly placed within the latter which is then stoppered. It is allowed to stand for 20 minutes in the balance case and then weighed. The salt is then placed in the crucible and the above process repeated.

Determination of Lithium, Potassium, and Sodium in the Presence of One Another.

After determining the weight of the combined chlorides, the potassium is determined in one portion as K_2PtCl_6 , and in a second portion the lithium is determined according to one of the following methods:

(a) *Gooch's Method.**

Principle.—Anhydrous LiCl is soluble in anhydrous amyl alcohol (15 parts of amyl alcohol dissolve in the cold 1 part of LiCl , or 10 c.c. dissolve 0.66 gm. LiCl) while KCl and NaCl are

* Proceedings of the Am. Acad. of Arts and Sciences. 22 [N. S. 14], 177.

difficultly soluble in this liquid (solubility of NaCl=1:30,000 of KCl=1:24,000).

Procedure.—The solution, after having been concentrated as far as possible, and which should not contain more than 0.2 gm. LiCl, is placed in a 50 c.c. Erlenmeyer flask, 5-6 c.c. of amyl alcohol (boiling point 132° C.) are added and the flask is placed upon an asbestos plate and cautiously heated. The aqueous solution at the bottom of the beaker soon begins to boil and the water vapor escapes through the upper layer of amyl alcohol.* As soon as all the water has been boiled off, the chlorides of sodium and potassium separate out, while the greater part of the lithium chloride is to be found in the alcoholic solution. During the evaporation of the aqueous LiCl solution, however, some LiOH is formed by hydrolysis, and the latter compound is insoluble in amyl alcohol. In order to bring this completely into solution, the clear amyl alcohol solution is treated with 2-3 drops of concentrated hydrochloric acid, boiled two or three minutes and filtered while still warm through a small asbestos filter. The crust which remains is composed of sodium and potassium chlorides and is washed with hot amyl alcohol, which has been boiled. The filtrate is evaporated to dryness, and the residue is dissolved in a little water after the addition of some dilute sulphuric acid. The solution is filtered from the carbonaceous residue into a weighed platinum crucible, evaporated as far as possible on the water-bath, the excess of sulphuric acid is removed by gentle heating over a flame (the crucible being held in an inclined position) and it is then weighed. The lithium sulphate thus obtained always contains small amounts of potassium and sodium sulphates in case these metals were present, so that from the weight obtained, 0.00041 gm. should be deducted for every 10 c.c. of the filtrate (exclusive of the alcohol used in washing the residue) in case only sodium chloride is present, or 0.00051 if only potassium chloride is present, and 0.00092 if both sodium and potassium chlorides are present

* To prevent loss by bumping at this point, the flask should be fitted with a cork stopper through which two tubes pass. If air is drawn through the liquid during the boiling, the water evaporates more quickly and without bumping.

If 10-20 mgm. of lithium chloride were present in the original salt mixture, then the residue obtained after filtering and washing with amyl alcohol is dissolved in a little water and the above treatment is repeated, the lithium being determined in the combined filtrates.

This method is very accurate, and, in the author's opinion it is to be preferred to all other methods for the determination of lithium.

(b) *Rammelsberg's Method.*

Principle.—Anhydrous lithium chloride is soluble in a mixture of equal parts alcohol and ether which has been saturated with hydrochloric acid gas, whereas the chlorides of sodium and potassium are practically insoluble therein.

Procedure.—The solution of the chlorides is evaporated to dryness in a small flask made of Jena glass and provided with a ground-glass, two-way stopper (p. 34, Fig. 21a). During the evaporation a current of dry air is passed into the flask through the long tube *a* and out through the short tube *b*. As soon as the residue has become dry the flask is placed in an oil-bath and heated for half an hour at 140-150° C., during which time dry hydrochloric acid gas is passed through the flask. The flask and its contents are allowed to cool with the hydrochloric acid still passing through the flask, after which the residue is treated with a few cubic centimeters of absolute alcohol, which has been saturated with hydrochloric acid gas and thereupon diluted with an equal volume of absolute ether. The flask is tightly stoppered and allowed to stand with frequent shaking for 12 hours. The solution is then poured through a filter, wet with the ether-alcohol mixture, and the residue is washed three times by decantation with ether-alcohol. A few more cubic centimeters of ether-alcohol are added to the contents of the flask and it is again allowed to stand for 12 hours; the liquid is then poured off and the residue is washed with ether-alcohol until a trace of the residue tested in the spectroscope shows the complete absence of lithium. The ether-alcohol extract is carefully evaporated to dryness in a water-bath containing lukewarm water, the residue is dissolved (after the addition of a little dilute sulphuric acid) in as little water as possible, transferred to a weighed

platinum crucible and treated with sufficient sulphuric acid to transform the lithium chloride present completely into sulphate.* The solution is evaporated as far as possible on the water-bath, then cautiously over the free flame, after which it is gently ignited and the residue of lithium sulphate is weighed.

Remark.—In the presence of considerable sodium and potassium salts it is advisable to remove the greater part of these by precipitation with hydrochloric acid gas (cf. p. 49), filtering through asbestos and washing the precipitate with concentrated hydrochloric acid until the residue no longer gives the lithium spectrum. The results obtained by this method are satisfactory.

Besides the above methods for the separation of lithium from sodium and potassium there are two other methods to be mentioned; that of W. Mayer † and that of A. Carnot.‡ According to Mayer the lithium is precipitated in the presence of NaOH as Li_3PO_4 , which, after being washed with ammonia water, is ignited and weighed. Rammelsberg, however, claims that the $\text{Li}_3\text{P}_2\text{O}_7$ always contains some sodium, so that the method is inaccurate. A great many experiments tried in the author's laboratory have led to the same conclusion.

According to Carnot the lithium is separated as the fluoride and then transformed to the sulphate. Walter § claims that this method is accurate but tedious.

Example for practice: Lepidolite analysis. (See Index.)

Indirect Determination of Lithium and Sodium.

The mixture of the two chlorides is weighed and the chlorine determined either gravimetrically or volumetrically. (See p. 3.)

Indirect Determination of Lithium and Potassium.

The method is the same.

* The above-described method has been modified by the author. Rammelsberg evaporates the chlorides in the water-bath, heats the residue till it melts and then after cooling extracts with ether-alcohol. By the evaporation and fusion of the lithium chloride there is formed some lithium hydroxide which is changed by the carbonic acid of the air to carbonate. Lithium carbonate is insoluble in ether-alcohol so that the extraction with ether-alcohol is not complete.

† Ann. Chem. Pharm., 98, 193, and Merling, Z. anal. Chem., 18, 563.

‡ Z. anal. Chem., 29, 332.

§ The Analyst, 16, 209.

AMMONIUM, NH_4 . Mol. Wt. 18.04.

Forms: NH_3 , NH_4Cl , $(\text{NH}_4)_2\text{PtCl}_6$, Pt, N.

We have two cases to distinguish:

1. The ammonium is present as chloride in aqueous solution.
2. The ammonium is present in solution, together with other cations and anions.

1. *The solution contains only NH_4^+ and Cl^- ions.* In this case the solution may be evaporated to dryness and the residue of ammonium chloride weighed; or the ammonium can be precipitated as $(\text{NH}_4)_2\text{PtCl}_6$ and the precipitate weighed; or the ammonium chloroplatinate can be ignited and the residue of platinum weighed.

(a) Determination as NH_4Cl .

The aqueous solution is treated with concentrated HCl and evaporated to a small volume on the water-bath at as low a temperature as possible, the solution is transferred to a platinum crucible (or one of porcelain), evaporated on the water-bath to dryness, and the covered crucible is dried to constant weight in a drying-oven. Good results are obtained, but they are always too low. On evaporating the aqueous solution some NH_4Cl is driven off, and the amount lost increases in proportion to the amount of water used and the temperature at which the evaporation takes place, on account of the NH_4Cl being partly decomposed according to the equation



into NH_3 and HCl, both of which are volatile.*

If, on the other hand, a little hydrochloric acid is added to the solution the dissociation is for the most part prevented so that the loss is reduced to a minimum. The ammonium chloride must be dried in a covered crucible as otherwise a small amount of the

* In cold, aqueous solution the NH_4Cl undergoes electrolytic dissociation to a considerable degree and no appreciable quantity of ammonia is formed by hydrolysis:

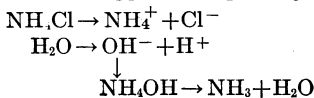

salt will be lost, but this amount is small in comparison with the amount which it is possible to lose during the evaporation.

(b) Determination as $(\text{NH}_4)_2\text{PtCl}_6$.

On heating $(\text{NH}_4)_2\text{PtCl}_6$ to 130°C . the salt is unchanged. In aqueous solution it undergoes only electrolytic dissociation so that the solution can be evaporated to dryness without appreciable loss of NH_3 .

The aqueous solution of ammonium chloride, therefore, is treated with an excess of chloroplatinic acid and a little hydrochloric acid and evaporated at as low a temperature as possible to dryness. The residue is taken up in absolute alcohol and filtered through a Gooch crucible, dried at 130°C ., and weighed. From this weight, the amount of ammonium chloride originally present can be correctly calculated by using the old atomic weight of platinum: $\text{Pt} = 196.9$. If the new value for the atomic weight of platinum ($\text{Pt} = 195.2$) is used, too high a value will be obtained for the amount of ammonium present, as was explained in the case of potassium.

If the weight of the $(\text{NH}_4)_2\text{PtCl}_6 = p$, then

$$\begin{aligned} p \times 0.2400 &= \text{NH}_4\text{Cl} \\ p \times 0.08095 &= \text{NH}_4 \\ p \times 0.07643 &= \text{NH}_3. \end{aligned}$$

(c) Determination as Platinum.

Instead of weighing the $(\text{NH}_4)_2\text{PtCl}_6$ as such, it can be decomposed by ignition* and the weight of the platinum remaining determined. If the old value for the atomic weight of platinum (196.9) is used in this determination the results obtained will be

* As ammonium chloroplatinate decrepitates strongly on being heated, the ignition must take place in a large porcelain crucible which is provided with a close-fitting cover. The precipitate must be heated gradually at first to prevent loss. It is best ignited according to the directions of Rose. The precipitate and filter are placed in the crucible with the filter-paper on top, the crucible is covered and heated over a very small flame until the paper is completely charred without allowing the vapor to escape visibly from the crucible. The crucible is then strongly ignited with free access of air until the charred filter is completely consumed.

about 0.4 per cent too low, while if the new value (195.2)* is used, the results will be about 0.8 per cent too high.

Correct results can be obtained by multiplying the weight of platinum (p) by the following factors:

$$p \times 0.54527 = \text{NH}_4\text{Cl};$$

$$p \times 0.18391 = \text{NH}_4;$$

$$p \times 0.17364 = \text{NH}_3.$$

2. The Ammonium is Present Together with Other Cations and Anions in Solution or in Solid Form.

(a) The solution is distilled after the addition of a strong base ($\text{NaOH}-\text{Ca}(\text{OH})_2$ †), the ammonia evolved is absorbed in hydrochloric acid and the resulting solution is analyzed according to 1.

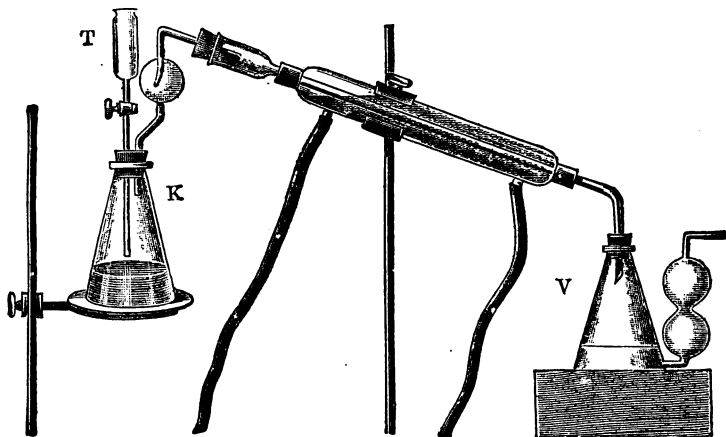

FIG. 24.

Procedure.—About 1 gm. of the substance to be analyzed is placed in the 400–500 c.c. Erlenmeyer flask K , it is dissolved in 200 c.c. of water, a few drops of litmus solution are added, and in case the

* In analyzing chloroplatinates of organic bases (by weighing the platinum) correct results may be obtained by using for the atomic weight of platinum the value 196.9.

† MgO is frequently recommended for expelling the ammonia. According to a private communication from Herr Bormann, of Neunkirch, this base is absolutely unsuited for this purpose.

solution reacts acid, sodium hydroxide solution (which has been previously boiled to expel traces of ammonia) is slowly added at *T* with constant shaking until the solution changes to blue, after which ten c.c. more of the caustic soda solution are added.* The liquid is then heated to boiling and 100 c.c. of it is carefully distilled into the receiver *V*, which already contains 20 c.c. of 2 N. hydrochloric acid. In order to make sure that no ammonia escapes from the receiver it is well to connect it with a small Peligot tube containing 5 c.c. of 2 N. hydrochloric acid and some distilled water.

After 100 c.c. of the liquid have distilled over, all the ammonia will be found in the receiver and can be determined according to 1 (*a*) or 1 (*b*); preferably the latter. The determination can be carried out much more quickly, however, if the receiver contains a measured amount of standardized acid and the excess is determined after the distillation by titrating with alkali (cf. Alkalimetry).

It is also possible to make an accurate determination of the amount of ammonia present by measuring the volume of the gas.†

Colorimetric Determination of Ammonium.

For the determination of such small amounts of ammonia as occur in drinking-water, the above methods are not suited. In this case the procedure is the same as was described in Vol. I, under *Ammonium* (In the case of mineral waters it is necessary to add more than one drop of the soda solution; the amount necessary is determined by adding litmus to a definite volume of the water and then adding the soda solution until the litmus changes to blue.) The distillate is received in 50 c.c. graduated Nessler tubes (in the fourth one there is usually no ammonia to be detected) and these are Nesslerized. The 50 c.c. of distillate is mixed with 2 c.c. of the Nessler solution and the yellow color produced is compared with the colors produced in the same way from a series of tubes containing known amounts of ammonia. When a stand-

* The separatory funnel *T* should be roughly calibrated before setting up the apparatus, by pouring water into it, one cubic centimeter at a time, and marking with a pencil the level of the liquid on the glass.

† Cf. Part III, Gas Analysis.

and is found of the same shade as the solution tested, then the two solutions contain the same amount of ammonia.

The ammonium chloride solution necessary for preparing the standards is prepared as follows:

3.141* gms. of ammonium chloride which has been dried at 100° C. are dissolved in 1 liter of water free from ammonia (cf. Vol. I, under *Ammonium*). The solution now contains 1 mgm. of ammonia (NH₃) per cubic centimeter; this however, is too strong for most purposes, so that 10 c.c. of it are taken and diluted to 1 liter. Of this solution 1 c.c. contains 0.01 mgm. NH₃. If the water to be analyzed contains considerable ammonia, a smaller portion should be taken for the analysis than in ordinary cases (500 c.c.) as otherwise the first distillate (50 c.c.) would give too intense a color with the Nessler solution. In such a case only 50 c.c. of the water should be taken for the analysis and this should be diluted to 500 c.c. with water free from ammonia and then distilled.

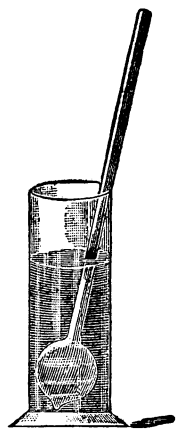

FIG. 25.

In order to ascertain how much of the water to take for the analysis, the following experiment should be made:

About 100 c.c. of the water to be tested are placed in a narrow cylinder (which is provided with a ground-glass stopper), 2 c.c. of a strongly alkaline sodium carbonate solution † are added to precipitate the calcium which may be present, the mixture is violently shaken and allowed to settle. From the clear supernatant liquid 50 c.c. are pipetted off into a Nessler tube, treated with 2 c.c. of Nessler solution and mixed. ‡ If a strong yellow color, or

* $\text{NH}_4\text{Cl} \div \text{NH}_3 = 53.50 \div 17.03 = 3.141$.

† 50 gms. NaOH and 50 gms. Na₂CO₃ (calcined) are dissolved in 600 c.c. of pure distilled water and the solution boiled until the volume is only 500 c.c.

‡ In the case of mineral waters rich in magnesium sulphate, the addition of the 10 c.c. of sodium carbonate solution often fails to prevent a turbidity on adding the Nessler reagent, which would render a colorimetric determination impossible. In this case 10 c.c. of a boiled BaCl₂ solution (120 gms. BaCl₂ + 2H₂O in 500 c.c. H₂O) should be added before treating the water with the sodium carbonate solution.

even a precipitate, is obtained, then only 50 c.c. of the water should be taken for analysis. If, on the other hand, there is not more than a faint coloration apparent, then 500 c.c. must be taken for the determination.

For the Nesslerization, the three cylinders each containing 50 c.c. of the distillate are placed over a sheet of white paper, treated with 2 c.c. of the Nessler reagent, and mixed. Beside them are placed a series of similar cylinders containing respectively 0.0, 0.5, 1.0, 1.5, 2.0, 2.5, 3.0 c.c. of the standard ammonium chloride solution diluted to 50 c.c. These are also treated with 2 c.c. of the Nessler reagent and by matching the colors obtained in the test with those obtained from known amounts of ammonia the amount present in the water can be easily estimated.

The Nessler reagent should give a distinct coloration with 500 c.c. of water containing 0.005 mgm. NH_3 ; if this is not the case, it must be made more sensitive by the addition of mercuric chloride solution.

For mixing the liquid in the cylinders it is convenient to employ a stirrer such as is shown in Fig. 25, the diameter of the bulb on the end being only slightly less than that of the cylinder. By moving this stirrer up and down twice the liquid becomes thoroughly mixed.

Kjeldahl's Method for Determining Nitrogen.

The methods which have been described thus far are suitable only for the determination of nitrogen when it is in solution in the form of NH_4^+ ions. It is, however, of great importance to be able to determine nitrogen when it is present other than as an ammonium compound (in protein, coal, etc.). Inasmuch as it is possible to determine the amount of ammonia present very accurately, and by the employment of volumetric methods, very quickly, methods were sought for the transformation into ammonia of the nitrogen originally present in some other form. This is readily brought about by the method of Kjeldahl and its modifications.

By the oxidation of nitrogenous organic substances with concentrated sulphuric acid, potassium permanganate, mercuric oxide, etc., the organic matter is destroyed and the nitrogen is completely changed to ammonium and held as ammonium sulphate, from which the ammonia can be readily distilled off.

Procedure for Kjeldahl's Nitrogen Determination (Wilfarth's Modification)*.—From 1 to 2 gms. of the substance to be analyzed are placed in a 500–600-c.c. flask, made of difficultly fusible potash glass, and to it are added 20 c.c. of sulphuric acid (3 volumes of concentrated acid mixed with 2 volumes of fuming sulphuric acid) and a few drops of mercury.† The flask is then heated in an iron dish covered with asbestos until its contents gently boil. It is important, however, to be sure that the substance should be thoroughly moistened by the sulphuric acid before the heating, especially in the case of mealy substances. In order to avoid a loss of nitrogenous matter, it is first heated for half a minute over a very small flame and then over a larger one, but in no case should the flame touch the flask above the part occupied by the liquid.

The heating is continued until the solution becomes clear and completely colorless. In the presence of iron compounds, however, the liquid is sometimes slightly yellow. The decomposition is usually complete in two or three hours. The liquid is then allowed to cool, the sides of the flask are washed down and the solution is diluted with about 250 c.c. of water. After it is thoroughly cool, 80 c.c. of caustic soda solution, free from nitrate, are quickly added and sufficient potassium sulphide solution (40 gms. commercial potassium sulphide to the liter) to completely precipitate the mercury and cause the liquid to appear black (25 c.c. of the potassium sulphide solution are usually sufficient). A few grains of powdered zinc are then added and the flask is quickly connected with the distilling apparatus. The distilling-tube dips into a 250–300-c.c. Erlenmeyer flask containing a known volume of normal sulphuric acid (10–20 c.c.) and sufficient water to cover the lower end of the condenser tube. As soon as a noticeable amount of water vapor begins to come over, it is no longer necessary to have the condenser tube dip into the sulphuric acid solution in the receiver. After 100 c.c. of the liquid have distilled over, the receiver is removed and the excess of sulphuric acid is determined by titration with

* Chem. Ztg., 9, 502.

† Gladding uses a mixture of H_2SO_4 and $KHSO_4$, which usually works very well. Then, as no mercury is added, the subsequent addition of Na_2S is unnecessary.

one-tenth normal sodium hydroxide solution, using methyl orange as an indicator.*

From the amount of sulphuric acid used, the amount of nitrogen present may be calculated as follows: Let t be the number of cubic centimeters of normal sulphuric acid neutralized by the ammonia evolved from a gms. of the substance, then this corresponds to

$$t \times 0.01401 \text{ gms. nitrogen,}$$

and the percentage of nitrogen in the substance is

$$a : t \times 0.01401 = 100 : x,$$

$$x = \frac{1.401 \times t}{a} = \text{per cent. nitrogen.}$$

If the nitrogen is originally present to a considerable extent in the form of nitrates, oxides, or cyanides, the above modification of Kjeldahl's method will not serve to change all of the nitrogen into ammonia. In such cases it is best to use the modification proposed by M. Jodlbauer:†

From 0.2–0.5 gm. of potassium nitrate (or the corresponding amount of another nitrate) are treated with 20 c.c. of concentrated sulphuric acid and 2.5 c.c. of phenolsulphonic acid (50 gms. of phenol dissolved in enough concentrated sulphuric acid of 66° Bé. to make 100 c.c. of solution) 2–3 gms. of zinc dust and 5 drops of chloroplatinic acid are added and the mixture heated. After heating the substance with this mixture for four hours, the liquid becomes colorless and is ready to be distilled with the caustic soda solution.

* In the titration it is best to add the alkali until the solution turns yellow, and then finish by adding enough acid to get a change to a pale pink. In standardizing the acid and alkali, the volume of the solution and the method of titrating must be the same as during the analysis proper.

† Z. anal. Chem., 27, 92.

MAGNESIUM, Mg. At. Wt. 24.32.

Forms: MgSO_4 , MgO , $\text{Mg}_2\text{P}_2\text{O}_7$.

(a) Determination as MgSO_4 .

This method for the determination of magnesium can always be employed when the magnesium is combined with an acid which can be volatilized by heating with sulphuric acid, and when no other metal besides ammonium is present. A weighed amount of the substance is placed in a platinum crucible and treated with a slight excess of concentrated sulphuric acid,* the mixture is evaporated on the water-bath as far as possible, and the excess of free sulphuric acid is removed by cautiously heating the crucible, held in an inclined position, over a free flame. Finally the dry mass is heated just to redness in a covered crucible, and after cooling in a desiccator, is weighed as quickly as possible, as the anhydrous magnesium sulphate is hygroscopic.

(b) Determination as MgO .

This method is seldom used in practice, and then only in case the magnesium is present in a form that can be readily changed to the oxide by ignition—i.e., as carbonate, nitrate or salt of an organic acid.† The procedure consists simply of at first carefully heating in a covered crucible, and finally with the full heat of the Teclu burner in a half-covered crucible.

(c) Determination as Magnesium Pyrophosphate.

This, the most important of all the methods for the determination of magnesium, is always applicable and depends upon the following principles: If the solution of a magnesium salt is treated with an alkali orthophosphate solution in the presence of ammonium chloride and ammonia, the magnesium is completely precipitated

*Substances which react violently with concentrated H_2SO_4 should be first treated with water, and dilute sulphuric acid added little by little.

† Magnesium chloride can be changed to the oxide by ignition with mercuric oxide in a porcelain evaporating-dish. Mercuric chloride and the excess of mercuric oxide are volatilized. In this way magnesium is often separated from the alkalis. (Translator.)

as magnesium ammonium phosphate, which by ignition is changed to magnesium pyrophosphate:



Formerly it was a common practice to precipitate magnesium ammonium phosphate in the cold. Neubauer* showed, however, that this sometimes leads to high results while at other times the results are low. The latter is the case when the precipitation takes place in strongly ammoniacal solutions containing but little ammonium salts, particularly when the phosphate solution is added slowly. Tribasic magnesium phosphate, $\text{Mg}_3(\text{PO}_4)_2$, contaminates the precipitate. On the other hand, the results are too high if the precipitation takes place in neutral or slightly ammoniacal solution in the presence of considerable ammonium salts. In this case more or less monomagnesium ammonium phosphate, $\text{Mg}(\text{NH}_4)_4(\text{PO}_4)_2$, is formed. This compound is changed to magnesium metaphosphate on gentle ignition.

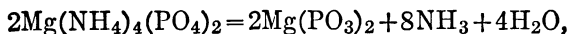

and the results are too high. When only a little of the metaphosphate is present, the temperature of the blast-lamp will eventually lead to volatilization of some phosphorus pentoxide, so that nearly correct results are then obtained.

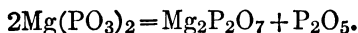

Neubauer recommends adding an excess of sodium phosphate to the slightly acid solution of the magnesium salt, then stirring in one-third of the solution volume of 10 per cent. ammonia, filtering after four or five hours, washing with 2.5 per cent. ammonia, dissolving the precipitate in a little dilute hydrochloric acid, adding a few drops of sodium phosphate solution, and precipitating by the addition of one-third volume of 10 per cent. ammonia. This method, however, gives too high results,

* Z. angew. Chem., 1896, 439. See also Gooch and Austin, Z. anorg. Chem., 20, 121.

e.g., 9.97, 9.95, and 9.98 per cent. Mg in $\text{MgSO}_4 \cdot 7\text{H}_2\text{O}$ instead of 9.88 per cent. Mg.

Correct results can be obtained by the method of B. Schmitz,* or of W. Gibbs.†

Method of B. Schmitz.

The acid solution, containing magnesium in the presence of ammonium salts,‡ is heated to boiling and then treated with an excess of sodium or ammonium phosphate. One-third the solution's volume of 10 per cent. ammonia is at once added, the solution allowed to cool and filtered through a Munroe crucible after standing for several hours. The precipitate is washed with 2.5 per cent. ammonia, dried and ignited very slowly, gradually increasing the heat until the precipitate is white. After cooling, the $\text{Mg}_2\text{P}_2\text{O}_7$ is weighed:

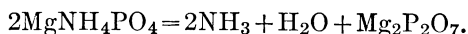

From the weight of the latter, p , the amount of magnesium can be calculated as follows:

$$\frac{2\text{Mg}}{\text{Mg}_2\text{P}_2\text{O}_7} \cdot p = \text{weight of magnesium.}$$

The precipitate can be filtered upon an ordinary filter, but in all cases the ignition must be gradual or it is almost impossible to obtain perfectly white pyrophosphate.

* Z. anal. Chem. 1906, 512; cf. Jorgensen, *ibid.* 1906, 278.

† Am. J. Sci. (3), 5, 114.

‡ Ammonium salts do no harm when the precipitation takes place in hot solution, but, on the contrary, cause the formation of a coarsely crystalline precipitate which is easy to filter.

Method of W. Gibbs.

The neutral, not too concentrated, solution of magnesium salt containing ammonium salts is treated at the boiling temperature with a normal solution of microcosmic salt, $\text{NaH}_2\text{NH}_4\text{PO}_4 + \text{H}_2\text{O}$, until no further precipitation takes place. Almost 90 per cent. of the magnesium present is at once thrown down as amorphous magnesium hydrogen phosphate, MgHPO_4 :

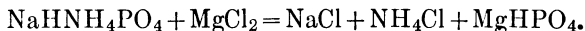

Then, while stirring the hot solution, about one-third volume of 10 per cent. ammonia is added whereby the amorphous precipitate is transformed into crystalline magnesium ammonium phosphate:

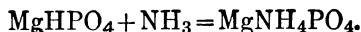

At the same time the magnesium remaining in solution is thrown down almost completely.

After standing two or three hours, the supernatant liquid is filtered off, and the precipitate washed three times by decantation with 2.5 per cent. ammonia, finally transferred to the filter, washed completely with 2.5 per cent. ammonia and dried in the hot closet. The dried precipitate is transferred as completely as possible to a weighed platinum crucible, the filter-paper burned in a platinum wire spiral, and the ash added to the main portion of the precipitate. The covered crucible is heated very gently at first until the ammonia is all dried off, then more strongly until the mass is snow white. The crucible is cooled in a desiccator and weighed.

Separation of Magnesium from the Alkalies.

The methods of Gibbs and of Schmitz serve to separate magnesium from the alkalies in those cases where the determination of magnesium alone is desired.

If it is desired to determine magnesium and the alkalies in one

and the same sample, it is best to use the Gooch and Eddy * modification of the

Schaffgottsche Method †

The method is based upon the fact that magnesium can be precipitated quantitatively, by means of an alcoholic solution of ammonium carbonate, as crystalline magnesium ammonium carbonate, $\text{MgCO}_3 \cdot (\text{NH}_4)_2\text{CO}_3 \cdot 6\text{H}_2\text{O}$.

Preparation of the Precipitant.—A mixture of 180 c.c. concentrated ammonia, 800 c.c. water, and 900 c.c. absolute alcohol is saturated with commercial ammonium carbonate. The liquid is shaken with the powdered carbonate, and after several hours the excess of the latter is removed by filtration.

Procedure.—The neutral solution containing only magnesium and the alkalis (lithium must not be present), preferably in the form of chlorides, is treated with an equal volume of absolute alcohol and then with an excess of the ammonium carbonate reagent. The liquid is vigorously stirred for a few minutes and allowed to stand for at least half an hour, whereupon it is filtered through a Gooch or Munroe crucible. The precipitate is washed with the precipitant, dried, ignited and weighed as MgO .

If considerable alkali is present the precipitate always contains a small quantity of it. In such cases the precipitate is dissolved in hydrochloric acid, the solution evaporated to dryness, the residue taken up in a little water, and the precipitation repeated.

The combined filtrates are evaporated to dryness and the alkali determined as described on page 43 et seq.

If, however, it is desired to separate magnesium from the alkalis in order that the latter may be determined, the magnesium may be precipitated as magnesium hydroxide, from a solution free from ammonium salts, by the addition of barium hydroxide solution.‡ The barium is then removed by ammonium carbonate and the alkalis determined in the filtrate. For the detailed description of this method see Silicate Analysis. Even in this case, however, the use of the Schaffgottsche method of separating magnesium from the alkalis is more satisfactory.

* *Z. anorg. Chem.*, 58, 427 (1908).

† *Pogg. Ann.*, 104, 482 (1858).

‡ Cf. footnote to page 65.

METALS OF GROUP IV.

CALCIUM, STRONTIUM, BARIUM.

CALCIUM, Ca. At. Wt. 40.09.

Forms: CaO, CaCO₃, CaSO₄.**I. Determination as Calcium Oxide (Lime), CaO.**

For the determination of calcium as CaO, it is best precipitated as the oxalate and converted to the oxide by strong ignition.

Procedure.—The neutral or slightly ammoniacal solution, which besides magnesium and the alkalies should contain no other metal,* is treated with ammonium chloride, heated to boiling, and precipitated by the addition of a boiling solution of ammonium oxalate. After standing some time, the precipitate becomes coarsely crystalline and settles to the bottom of the beaker, when a little more ammonium oxalate solution is added to make sure that the precipitation has been complete. It is allowed to stand four hours, when the clear liquid is poured through a filter, the precipitate is covered with boiling water containing ammonium oxalate,† allowed to settle, filtered, and the operation repeated three times. Finally the whole precipitate is transferred to the filter and washed with hot water containing ammonium oxalate until free from chloride. The precipitate is warmed in the hot closet until nearly dry, when it is placed together with the filter in a platinum crucible and ignited wet. It should be heated cautiously at first in order that the too rapid evolution of carbonic oxide will not cause loss. After the filter is burnt the crucible is covered and strongly heated at first over the Teclu burner and finally over the blast-lamp for twenty minutes.

The crucible while still quite warm is placed, in the desiccator shown in Fig. 7, near an open weighing-beaker and allowed to remain there for one hour. During the cooling, the air enters the desiccator, through the U tube, whose outer half is filled with

* If magnesium is present, the precipitation should be carried out as described on page 76.

† T. W. Richards found that the precipitate was appreciably soluble in pure water but practically insoluble in a dilute solution of ammonium oxalate (*Z. anorg. Chem.*, 28, 85 (1901)).

soda-lime and whose inner half contains calcium chloride, in a dry condition and free from carbonic acid gas. The crucible is now placed in the weighing-beaker, quickly covered and allowed to stand for half an hour in the air near the balance, after which it is weighed. The crucible is again heated over the blast-lamp for ten minutes and is cooled in exactly the same way and weighed. Should the weight not be found constant, the process must be repeated. The above directions when carefully followed usually enable one to obtain a constant weight on the second ignition.

Example.—Calcite: 0.5 gm. of the finely powdered material which has been dried at 100° is placed in a 300-c.c. beaker and moistened with 20 c.c. of water. The beaker is covered with a watch-glass, concentrated hydrochloric acid is added drop by drop, and the liquid is finally heated until all is dissolved. The solution is then boiled for fifteen minutes to expel all carbon dioxide, neutralized carefully with ammonia, diluted with 150–200 c.c. of hot water, and precipitated with ammonium oxalate as above described.

Remark.—If both solutions are not boiling hot during the precipitation, the calcium oxalate forms very fine crystals; it then settles very slowly and passes readily through the filter.

Calcium oxalate is almost insoluble in water and acetic acid in the presence of ammonium oxalate, but readily soluble in mineral acids.

2. Determination of Calcium as Sulphate, CaSO_4 .

This method is chiefly used for the analysis of calcium salts of organic acids. For this purpose the calcium salt is ignited in a weighed platinum crucible, after which the crucible is covered with a watch-glass, carefully treated with dilute sulphuric acid and warmed upon the water-bath until there is no longer any evolution of carbon dioxide. The under side of the watch-glass is carefully washed and the liquid evaporated as far as possible on the bath. The excess of sulphuric acid is then carefully driven off by inclining the crucible and heating over the free flame (or in an air-bath) (cf. Fig. 11, p. 27). The residue is *gently* ignited and weighed. By strong ignition, calcium sulphate loses SO_3 .*

*0.2052 gm. CaSO_4 remained unchanged in weight after heating for one hour to dark redness; but on heating with the full flame of a Teclu burner, it lost 0.0004 gm. in weight. On heating for one hour over the blast lamp it lost 0.0051 gm. (J. Weber.)

Calcium may also be precipitated as calcium sulphate. The solution, which should contain as little free acid as possible, is treated with an excess of dilute sulphuric acid, four volumes of alcohol are added, and the mixture is allowed to stand 12 hours. It is then filtered off, washed with 70 per cent. alcohol, dried, separated from the filter as completely as possible, the filter burned in a platinum spiral, and the ash added to the main part of the precipitate in a platinum crucible, gently ignited and weighed.

3. Determination of Calcium as Carbonate, CaCO_3 .

Only in rare cases is calcium precipitated as carbonate by ammonium carbonate in the presence of ammonia. The filtered and washed precipitate is gently ignited and weighed as carbonate. After weighing it is necessary to moisten the residue with a little ammonium carbonate solution, evaporate to dryness on the water-bath, and again ignite gently. This is done in order to change small amounts of calcium oxide, which may have been formed during the burning of the filter-paper, back to carbonate.

In the presence of considerable ammonium chloride the precipitation of calcium by means of ammonium carbonate is not quite complete, whereas the precipitation with ammonium oxalate always is. Consequently it is advisable in all cases to precipitate the calcium as oxalate and weigh it as the oxide. If the oxalate is ignited gently, however, it can be weighed as the carbonate.

STRONTIUM, Sr. At. Wt. 87.63.

Forms: SrSO_4 , SrCO_3 , SrO .

The determination as the sulphate is the most accurate.

Determination of Strontium as Sulphate, SrSO_4 .

Procedure.—To the neutral solution containing strontium, a slight excess of dilute sulphuric acid is added and as much alcohol as there is volume of solution. After stirring well, the mixture is allowed to stand twelve hours, filtered and washed, at first with 50 per cent. alcohol, to which a little sulphuric acid has been added, and finally with pure alcohol until the wash water no longer gives the sulphuric acid reaction. The precipitate is

dried and ignited as described under the determination of calcium as sulphate.

Solubility of Strontium Sulphate according to Fresenius.

6895 parts of water at the ordinary temperature (17-20°) dissolve 1 part of SrSO_4 .

9638 parts of boiling water dissolve 1 part SrSO_4 .

The sulphate is less soluble in water containing sulphuric acid:

12,000 parts of water containing sulphuric acid dissolves 1 part SrSO_4 . The precipitate is soluble in concentrated sulphuric acid, so that the water should not contain very much sulphuric acid.

In cold, dilute hydrochloric or nitric acid, strontium sulphate is considerably more soluble, and also in solutions containing acetic acid, magnesium chloride, or alkali chloride.

If, therefore, considerable free acid is present, it should be removed by evaporating the solution to dryness and dissolving the residue in water. The strontium is then precipitated as above described.

Determination of Strontium as Oxide, SrO , or as Carbonate, SrCO_3 .

The strontium is precipitated as carbonate, or in some cases as oxalate, and changed by ignition to the oxide as described under calcium.

Strontium carbonate is decomposed by heat more difficultly than calcium carbonate and the determination as carbonate is very satisfactory. It is advisable to treat the precipitate as described under calcium, although it is usually unnecessary to heat with additional ammonium carbonate.

Solubility of Strontium Carbonate in Water according to Fresenius.

18,045 parts of water dissolve at ordinary temperatures 1 part of SrCO_3 .

In water containing ammonium carbonate the salt is much less soluble; on the other hand, ammonium chloride and ammonium nitrate increase its solubility.

In case calcium, strontium, magnesium and alkali salts are present together, as in minerals and in mineral waters, the calcium

and strontium are both precipitated as oxalates and transformed by ignition into the oxides. Cf. pp. 78, 79.

Solubility of Strontium Oxalate in Water.

12,000 parts of water at ordinary temperatures dissolve 1 part of $\text{SrC}_2\text{O}_4 + 2\frac{1}{2}\text{H}_2\text{O}$.

The solubility is very much less in water containing ammonium oxalate.

BARIUM, Ba. At. Wt. 137.37.

Forms: BaSO_4 , BaCrO_4 , BaCO_3 .

1. Determination as Barium Sulphate.

The solution, slightly acid with hydrochloric acid, is heated to boiling and precipitated by the addition of an excess of hot, dilute sulphuric acid. It is allowed to stand on the water-bath until the precipitate has settled, the solution is then poured through a filter, and the precipitate is washed four times with 50 c.c. of water to which a few drops of sulphuric acid have been added. The precipitate is transferred to the filter and washed with hot water until the wash water ceases to give the sulphuric acid reaction. It is then dried somewhat, ignited wet in a platinum crucible, and weighed *without* previous heating over the blast-lamp.

Remark.—By the combustion of the filter-paper there is usually a partial reduction of the barium sulphate to sulphide, but the latter, on being gently ignited in an inclined crucible, is readily changed back to sulphate, so that there is no loss to be feared.

The procedure for the determination of barium as carbonate is the same as was described under calcium.

Solubility of Barium Sulphate in Water.—344,000 parts of water dissolve 1 part of BaSO_4 .

2. Determination of Barium as Chromate.

The neutral solution of the barium salt is diluted to about 200 c.c., treated with 4–6 drops of acetic acid (sp. gr. 1.065), heated to boiling, precipitated with a slight excess of ammonium chromate (prepared by adding ammonia to a solution of ammonium bichromate free from sulphate, until the color becomes yellow), and

allowed to cool. The precipitate is filtered off through a Gooch crucible and washed with hot water until 20 drops of the filtrate give scarcely any reddish-brown coloration with a neutral solution of silver nitrate. The precipitate is dried in the hot closet, after which the crucible is fastened to a larger porcelain crucible by means of an asbestos ring, so that there remains a space of about $\frac{1}{2}$ cm. between the two crucibles (cf. p. 27), and the open crucible is ignited over the free flame until the precipitate becomes a bright yellow.*

Solubility of Barium Chromate.†

86,957	parts of water at ordinary temperatures dissolve 1 part BaCrO_4 .
23,000	" " boiling water dissolve 1 part BaCrO_4 .
49,381	" " a 0.75 per cent. ammonium acetate solution (at 15°) dissolve 1 part BaCrO_4 .
45,152	parts of a 0.5 per cent. ammonium nitrate solution (at 14°) dissolve 1 part BaCrO_4 .
23,555	parts of a 1.5 per cent. ammonium acetate solution (at 15°) dissolve 1 part BaCrO_4 .
22,988	parts of 0.5 per cent. ammonium nitrate solution dissolve 1 part BaCrO_4 .
3,670	parts of 1 per cent. acetic acid solution dissolve 1 part BaCrO_4 .
2,618	" " 5 " " " " " " 1 " "
1,986	" " 10 " " " " " " 1 " "
1,813	" " 10 " " chromic acid solution dissolve 1 part BaCrO_4 .

The solubility of barium chromate, therefore, increases considerably with increasing concentrations of either acetic or chromic acids; the solubility is affected to a much less degree by solutions containing neutral ammonium salts. By the additions of small amounts of neutral ammonium chromate the solubility becomes lessened to nearly zero.

* Oftentimes small amounts of the precipitate are reduced to chromic oxide by traces of organic matter, whereby it appears slightly greenish. By long-continued ignition in an open crucible, the chromic oxide is changed back to chromate, when the precipitate appears a homogeneous yellow throughout.

† P. Schweizer, *Z. anal. Chem.*, 1890, p. 414, and R. Fresenius, *ibid.*, 1890, p. 418.

SEPARATION OF THE ALKALINE EARTHS FROM MAGNESIUM AND FROM THE ALKALIES.

1. Separation of Calcium from Magnesium (and Alkalies).

The separation depends upon the different solubilities of the two oxalates. Calcium oxalate is practically insoluble in hot water, whereas magnesium oxalate is fairly soluble; 1500 parts of cold water, or 1300 parts of boiling water, dissolve 1 part of $\text{MgC}_2\text{O}_4 \cdot 2\text{H}_2\text{O}$. In an excess of the precipitant, however, magnesium oxalate is much more soluble owing to the formation of complex salts.

If calcium is precipitated as oxalate from a dilute solution in the presence of magnesium, some magnesium oxalate is *occluded* by the calcium oxalate precipitate even when the solution is by no means saturated with magnesium oxalate, and high results are obtained for calcium. In such cases the error is usually compensated according to Fresenius, by dissolving the precipitate in hydrochloric acid and repeating the precipitation with ammonia and ammonium oxalate.

The work of T. W. Richards* has shown, however, that the quantity of magnesium oxalate occluded is dependent upon the concentration of the *undissociated* magnesium oxalate in solution, and upon the time in which the calcium oxalate is in contact with the solution. Consequently anything that prevents the dissociation of magnesium oxalate will tend to increase the amount of occlusion and thereby increase the result of the calcium determination. Anything that will cause the ionization of the magnesium oxalate serves to reduce the amount of error.

Concentrating the solution and increasing the amount of oxalate ions in solution by the addition of considerable ammonium oxalate, both tend to repress the dissociation of the magnesium oxalate. The dissociation of this compound is favored by the presence of hydrogen ions and by dilution.

A considerable excess of ammonium oxalate is necessary in the quantitative precipitation of calcium and, moreover, mag-

* Z. anorg. Chem., 28, 71 (1901).

nesium oxalate forms readily soluble complex salts with undissociated ammonium oxalate. It is desirable, therefore, to prevent the dissociation of the ammonium oxalate as much as possible, and this is accomplished by the addition of another ammonium salt, preferably the chloride.

Procedure.—Dilute the solution with hot water so that the magnesium is present in a concentration of not over fiftieth normal, and add a considerable quantity of ammonium chloride, if it is not already present. To precipitate the calcium, add a sufficient volume of boiling oxalic acid solution, containing three or four equivalents of hydrochloric acid to lessen the dissociation of the oxalic acid. Introduce a little methyl orange into the boiling solution, and add ammonia until a yellow coloration is produced. The ammonia should not be added all at once, but in small quantities from time to time so that about half an hour is consumed in the operation.

After the neutralization add a considerable excess of hot ammonium oxalate solution, allow to stand four hours but not longer on account of the fact that the occlusion increases with the length of time, filter, and wash with hot, one per cent. ammonium oxalate until the filtrate gives no test for chloride after acidifying a sample with nitric acid.

Although this precipitate contains a little magnesium (0.1–0.2 per cent.) it is also true that an almost equal amount of magnesium passes into the filtrate, so that it is not advisable to repeat the precipitation when made in this way.

Alternate Method.

W. C. Blasdale* has studied the separation of calcium from different amounts of magnesium and succeeded in getting excellent results by a somewhat simpler method. The acid solution containing not more than 0.6 gm. of calcium and magnesium oxides is brought to a volume of 300 c.c., and heated to boiling; 3.5 gms. of ammonium chloride are added, if not already present, and 1 gm. of oxalic acid. The complete precipitation of the calcium is then accomplished by slowly neutralizing the hot solution

* J. Am. Chem. Soc., **31**, 917 (1909).

with 1 per cent. ammonia added during five minutes. The precipitate is allowed to stand for an hour before filtering. If considerably more magnesium than calcium is present, the precipitation is effected in two stages. First only enough oxalic acid is added to combine with all the calcium present. The solution is slowly neutralized as before and allowed to stand ten minutes. Then the balance of the oxalic acid is added, the solution made alkaline and allowed to stand for an hour. With more than ten times as much magnesium as calcium, a double precipitation is desirable.

In the filtrate the magnesium can be precipitated by the addition of ammonia and sodium phosphate. If, however, large amounts of ammonium salts are present it is preferable to evaporate to dryness in a platinum or porcelain dish, to dry the residue at 110–130° for an hour or longer, and to expel the ammonium salts by gentle ignition. The residue is taken up in a little warm hydrochloric acid, diluted with water, a little carbon residue filtered off and the magnesium determined as pyrophosphate. (Pages 66–69.)

II. Separation of Strontium from Magnesium.

This separation finds practical application in the analysis of almost all mineral waters and of minerals containing strontium. In all of these cases, however, strontium occurs in relatively small amounts in the presence of large amounts of calcium and varying amounts of magnesium, so that it is a question, first, of separating calcium and strontium from magnesium. This separation is effected by the precipitation of the calcium and strontium as oxalates as described on pp. 70 and 73.

The filtrate containing magnesium may also contain traces of strontium; hence, after the removal of the ammonium salts by ignition, the residue is dissolved in hydrochloric acid, sulphuric acid and alcohol are added, and the solution is allowed to stand for twelve hours. Any resulting precipitate, consisting of strontium or barium sulphate, is filtered off and weighed. From this filtrate the magnesium is precipitated as magnesium ammonium phosphate as described on p. 66, and weighed as the pyrophosphate.

III. Separation of Barium from Magnesium.

In case it is desired to separate only barium from magnesium, the solution (which must be free from nitric acid) is acidified with hydrochloric acid, heated to boiling, and the barium precipitated by the addition of boiling, dilute sulphuric acid (cf. p. 74). The magnesium is precipitated from the filtrate as magnesium ammonium phosphate in the usual way. In most cases, however, a separation of barium, strontium, and calcium from the magnesium is involved. For this purpose the three alkaline earths are precipitated as oxalates, and any barium or strontium remaining in the filtrate is precipitated as described under II. The magnesium is determined in the final filtrate.

IV. Separation of the Alkaline Earths from One Another.

Principle.—The mixture of the dry nitrates is treated with ether-alcohol, which dissolves calcium nitrate alone. The residue is taken up in water, the barium is precipitated as chromate, and the strontium is determined in the filtrate as sulphate.

PROCEDURE.

(a) Separation of Calcium from Strontium and Barium according to Rose-Stromeyer-Fresenius.

The three metals are assumed to be present together in solution in the form of their nitrates. The solution is evaporated in a small Erlenmeyer flask, as described under lithium, p. 55, in an oil-bath, meanwhile passing a stream of dry, warm air through the flask. When all the water is evaporated, the temperature of the bath is raised to 140° C. and maintained at this temperature for one to two hours, still passing the current of warm air through the flask. After cooling, the dry residue is treated with ten times its weight of absolute alcohol, corked up, and allowed to stand with frequent shaking for one to two hours. An equal volume of ether is now added, the flask closed, shaken, and again allowed to stand twelve hours. It is then filtered through a filter moistened with ether-alcohol and washed with ether-alcohol until a few drops of the filtrate evaporated on platinum-foil leave no residue

The filtrate is evaporated to dryness in a lukewarm water-bath, the calcium nitrate is dissolved in water, precipitated as the oxalate, and after ignition is weighed as the oxide.

Remark.—In case only a small amount of calcium is present (not more than about 0.5 gm.) the above separation is complete. With large amounts of calcium, the residue of strontium and barium nitrates almost always contains some calcium. In this case the aqueous solution is again evaporated to dryness in the same way as before and the treatment with alcohol and ether repeated. The calcium is then determined in the combined filtrates.

This separation finds application in the analysis of most mineral waters.

(b) Separation of Barium from Strontium according to Fresenius.*

Requirements.—1. A solution of $(\text{NH}_4)_2\text{CrO}_4$ (1 c.c. of the solution should contain 0.1 gm. of the salt). The solution is prepared by adding ammonia to a solution of ammonium bichromate (free from sulphate) until the color of the solution becomes yellow. The solution should be left acid rather than alkaline.

2. A solution of ammonium acetate (1 c.c. containing 0.31 gm. of the salt).

3. Acetic acid of sp. gr. 1.065.

4. Nitric acid of sp. gr. 1.20.

Procedure.—The residue, consisting of strontium and barium nitrates, is dissolved in a little water and for each gram of salt mixture the solution is diluted until the concentration corresponds to 300 c.c., heated to boiling, treated with six drops of acetic acid and about 10 c.c. of ammonium chromate solution (this should be an excess over the theoretical amount necessary) and allowed to stand one hour. The precipitate of barium chromate is washed by decantation with water containing ammonium chromate until the wash water no longer gives a precipitate with ammonia and ammonium carbonate; it is then washed with pure hot water until the last washing gives only a slight reddish-brown

* Z. anal. Chem., 29, 427 (1890).

coloration with neutral silver nitrate solution. The precipitate on the filter still contains a little strontium. It is carefully washed back into the vessel in which the precipitation took place, while any precipitate remaining on the filter is dissolved in a little warm dilute nitric acid and washed into the dish, finally adding enough nitric acid to the precipitate so that it dissolves completely on warming (about 2 c.c. of nitric acid being usually necessary). The solution is then diluted to 200 c.c., heated to boiling, treated with 5 c.c. of ammonium acetate solution, added little by little, and finally with enough ammonium chromate to cause the disappearance of the odor of acetic acid from the solution (usually about 10 c.c. are necessary). After standing one hour the liquid is poured through a Gooch crucible, the residue is treated in the dish with hot water, allowed to cool, then filtered and washed with cold water until the filtrate gives only a slight opalescence with neutral silver nitrate. The precipitate is dried, ignited gently in an air-bath (cf. p. 75), and weighed as BaCrO_4 . The filtrate is treated with 1 c.c. nitric acid, concentrated somewhat, and the strontium precipitated as carbonate by the addition of ammonia and ammonium carbonate. The precipitate, which always contains some chromate, is washed once with hot water, dissolved in hydrochloric acid, and the strontium determined as sulphate, according to p. 72.

The results obtained according to this method are very satisfactory. Experiments performed in this laboratory* completely confirm the results obtained by Fresenius.

Remark.—In the opinion of the author, all other methods for the separation of the alkaline earths give incorrect results; for that reason they will not be discussed in this book.

* The results of seven experiments gave (a) for the percentage of barium chromate obtained: 99.9, 99.9, 100.3, 100.4, 100.7, 100.6; mean, 100.3 per cent.; (b) for strontium sulphate, 100.9, 99.73, 99.86, 99.84, 99.47, 99.77. 99.6; mean, 99.75 per cent. (H. Schmidt.)

METALS OF GROUP III.

**ALUMINIUM, CHROMIUM, TITANIUM, IRON, URANIUM, NICKEL,
COBALT, ZINC, AND MANGANESE.**

A. DIVISION OF THE SESQUIOXIDES.

ALUMINIUM, CHROMIUM, IRON, TITANIUM, AND URANIUM.

ALUMINIUM, Al. At. Wt. 27.1.

Form: Al_2O_3 .

In order to determine aluminium in this form, the metal is precipitated as its hydroxide and converted to its oxide by ignition of the precipitate.

It must not be forgotten, however, that aluminium hydroxide exists in a soluble form (hydrosol) and in an insoluble form (hydrogel); and further that the hydrosol is not completely changed by boiling into insoluble hydrogel. To accomplish this the presence of salts in solution (preferably ammonium salts) is also necessary. Since, however, ammonium salts become acid on long boiling (due to the escape of ammonia) there is danger of the aluminium hydroxide being redissolved. Furthermore, it is true that the hydrogel gradually changes over into hydrosol by standing in a solution containing only a small amount of dissolved salts, or by remaining in a hot solution containing only a small amount of dissolved salts.

From these facts the following procedure is derived:

The solution containing the aluminium (but no phosphoric acid, or anything but aluminium that is precipitated by ammonia) is treated with considerable ammonium chloride, or ammonium nitrate, heated to boiling in a platinum or porcelain vessel, and a slight excess of ammonia* is added. The precipitate is allowed to settle, after which the clear solution is poured through a filter which rests on a platinum cone, but without applying suction.

*The ammonia should be freshly distilled. When it has been kept for any length of time in glass bottles, the ammonia invariably contains silica, and this leads to high results in the case of all precipitates formed by adding ammonia to an acid solution.

The precipitate is washed three times by decantation with hot water to which a drop of ammonia and a little ammonium nitrate has been added, and finally transferred to the filter. The precipitate is now washed as quickly as possible with the hot wash liquid (so that the precipitate is thoroughly churned up each time) until the filtrate ceases to give a test for chlorine. The precipitate is then dried as completely as possible by the application of suction and ignited wet in a platinum crucible. After the precipitate and ash have become white, the covered crucible is heated over the blast-lamp for about ten minutes, cooled in a desiccator and weighed. The process is repeated until a constant weight is obtained.

Determination of Aluminium by the Method of Chancel.*

In the determination of aluminium in a sample of alum by precipitation with ammonia, there are a number of difficulties to overcome. In the first place the precipitate always contains more or less basic aluminium sulphate, and it requires long ignition to expel the last traces of sulphuric anhydride. It is, to be sure, possible to wash out all the sulphate by means of a solution of ammonia and ammonium nitrate; the operation, however, is very tedious and a large quantity of the wash liquid is required. Another disadvantage arises from the fact that the filtration takes place very slowly, even when the precipitate contains basic sulphate, on account of the slimy nature of aluminium hydroxide.

By the method of Chancel and in the two following methods these difficulties are overcome.

The principle of this and the following methods consists in neutralizing, by salts of weak acids, the mineral acid that is set free in the hydrolysis of an aluminium salt; the weak acid is finally removed by boiling or neutralization. In the Chancel method the mineral acid is neutralized by sodium thiosulphate,

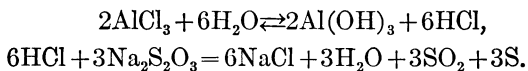

Procedure.—The dilute, neutral solution (about 0.1 gm. Al

* Compt. rend., 46, 987; Z. anal. Chem., 3, 391.

in 200 c.c.) is treated with an excess of sodium thiosulphate and boiled until all traces of SO_2 are expelled. Enough ammonia * is then added so that the odor is barely perceptible after blowing away the vapors, and the boiling is continued a little longer. The precipitate of $\text{Al}(\text{OH})_3$ and S is filtered off, washed with hot water, and ignited in a porcelain crucible. Such a precipitate of $\text{Al}(\text{OH})_3$ is much denser than that produced by direct precipitation with ammonia and is very easy to filter and wash.

Remark.—This method is often employed for separating aluminium from iron. Ferric iron is reduced to ferrous salt by the sodium thiosulphate and is not precipitated. In this case, however, the final neutralization with ammonia, as prescribed in the above directions, should not be carried out or a little iron will come down.

Determination of Aluminium by the Method of Alfred Stock.†

The aqueous solution of the aluminium salt, which on account of hydrolysis always shows an acid reaction,

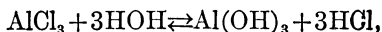

is treated in the cold with a mixture of potassium iodide and potassium iodate. This mixture in the presence of acid is decomposed in accordance with the equation

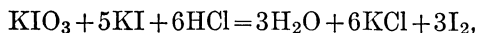

whereby the equilibrium which existed in the hydrolysis of the aluminium salt is disturbed and the first reaction continues to take place until all the aluminum is precipitated. If now the iodine in the solution is made to react with sodium thiosulphate and the mixture is heated on the water bath for half an hour, the precipitate collects in such a condition that it can be quickly filtered and washed.

Procedure.—The solution in which the aluminum is to be determined should be very slightly acid; if more acid is present sodium hydroxide is added until a slight permanent precipitate is obtained which is redissolved by means of a

* If the addition of ammonia is omitted, the solution will retain traces of aluminium.

† Ber., 1900, 548.

few drops of hydrochloric acid. Thereupon equal volumes of a 25 per cent. potassium iodide solution and a saturated potassium iodate solution (about 7 per cent. KIO_3) are added. After about five minutes the solution is decolorized by the addition of a 20 per cent. sodium thiosulphate solution and a little of the potassium iodide and iodate mixture is added in order to make sure that enough was added in the first place. One or two c.c. more of sodium thiosulphate are added and the solution heated half an hour on the water bath. The pure white precipitate settles out well, and can be filtered through a filter with relatively wide pores, washed with hot water, ignited and weighed as Al_2O_3 .

Remark.—The presence of calcium, magnesium and boric acid does not interfere with the above determination, but if phosphoric acid is contained in the solution, the phosphate of aluminum is precipitated. It is obvious that the method cannot be employed in the presence of organic substances such as tartaric acid, citric acid, sugar, etc., which prevent the precipitation of aluminium hydroxide.

Determination of Aluminium by the Method of G. Wynkoop * and of E. Schirm. †

Principle.—If a neutral solution of aluminium (iron, chromium, or titanium) is boiled with an excess of sodium or ammonium nitrite until no more fumes are evolved, aluminium hydroxide is precipitated in a form that can be as easily filtered as that of the last methods.

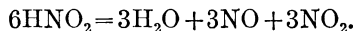
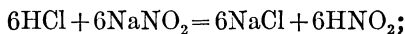
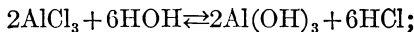

Procedure.—If the solution is acid, enough ammonia is added so that the precipitate first formed dissolves only slowly on

* J. Am. Chem. Soc., 19, 434 (1897).

† Chem. Ztg., 1909, 877.

stirring. An excess of a 6 per cent. solution of pure ammonium nitrite* is then added, the solution diluted to 250 c.c. and boiled until no more fumes of nitrous oxides are evolved (about 20 minutes). The precipitate is filtered, washed with hot water, ignited wet in a platinum crucible, and weighed as Al_2O_3 .

Remark.—In the presence of more than 1 per cent. of ammonium salts, these are hydrolyzed enough so that the solution remains acid and the precipitation of the aluminium is incomplete even after long boiling. In such a case, after the vapors of nitrogen peroxide are no longer visible, ammonia is added drop by drop until the odor is barely perceptible. The precipitate is allowed to settle while the beaker is on the water-bath, and the analysis is finished as above.

If the solution contains only aluminium in the form of its chloride, nitrate, or sulphate, it can be determined by evaporating the solution in a platinum crucible on the water-bath with the addition of a little sulphuric acid, the excess of the latter being finally removed by cautious heating over the free flame in an inclined crucible. The residue of aluminium sulphate is then changed to the oxide by strong ignition over the blast-lamp.

In the case of organic salts of organic acids, the oxide is readily obtained by careful ignition of the salt in a platinum crucible.

* Sometimes the reagent contains a little barium which should be precipitated with ammonium sulphate before using it in an analysis.

IRON, Fe. At. Wt. 55.84.

Forms: **Ferric Oxide, Fe_2O_3 ,** and **Metallic Iron.**

Determination as Fe_2O_3 .

(a) **By Precipitation with Ammonia.**

This is the form chiefly used for the gravimetric determination of iron. The solution containing the ferric salt in the presence of ammonium chloride is heated to about 70°C . in a porcelain dish or Jena beaker * and precipitated by means of a slight excess of ammonia. The precipitate is washed by decantation with hot water and finally with a strong stream of hot water from the wash-bottle.† It is ignited gradually in a platinum crucible and finally in the half-covered crucible over the Bunsen burner.‡ The ferric oxide obtained varies in its appearance according to the temperature to which it has been heated. Gently ignited ferric oxide is reddish brown, whereas when strongly ignited it has almost the appearance of graphite. Both forms are difficultly soluble in dilute hydrochloric acid, but can be readily dissolved by digesting with concentrated hydrochloric acid on the water-bath.

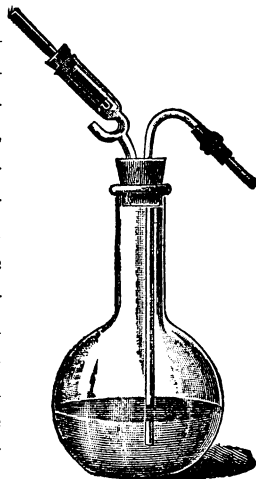

FIG. 26.

(b) **By Precipitation with Ammonium Nitrite.**

The precipitation of $\text{Fe}(\text{OH})_3$ from neutral solutions of ferric salts takes place as described for aluminium, p. 85.

* Too high results are invariably obtained in ordinary glass vessels. The ammonia should be freshly distilled or the results will be high.

† For this purpose a wash-bottle such as is shown in Fig. 26 is useful. By blowing through the long arm of the U-tube (which is provided with a Bunsen valve) and placing the thumb over the short arm a continuous stream of water is maintained which can be stopped at any time by removing the thumb.

‡ It is not advisable to heat the covered crucible over the blast on account of the danger of forming some Fe_3O_4 . The magnetism of such a precipitate can be shown by placing a magnet outside the platinum crucible and moving it slowly up and down.

If the iron is in solution either as the ferrous or ferric salt of a volatile acid, it can be readily converted into ferric oxide by evaporation with sulphuric acid and ignition of the residue.

2. Determination as Metallic Iron.

Iron may be determined by electrolysis, but this method offers no advantages over the gravimetric method just described or the following volumetric process, so that it will not be discussed in this book.

In the case of the analysis of oxide iron ores or of mixtures of considerable iron oxide with comparatively little alumina, titanium dioxide, or silica, the following method is accurate and rapid.*

The finely powdered and weighed † substance contained in a porcelain boat is introduced into a tube of difficultly fusible glass and heated to redness in a stream of dry hydrogen until no more drops of water condense on the cool front end of the tube and the contents of the boat appear gray and not black. By this means the ferric oxide is reduced to metallic iron:

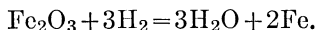

After cooling in the stream of hydrogen, the boat and its contents are again weighed after remaining some time in a desiccator. The loss in weight p represents the amount of oxygen originally combined with the iron, from which the amount of iron can be calculated:

$$3\text{O} : 2\text{Fe} = p : x$$

$$x = \frac{2\text{Fe}}{3\text{O}} \cdot p.$$

Remark.—In attempting to reduce ferric oxide to iron by means of hydrogen, it is very important to heat the oxide to bright

* Rivot, *Ann. Chem. Phys.*, 3. Serie, **30**, 188 (1850); *Liebig's Ann.*, **78**, 211 (185).

† Ferric oxide after having been powdered and ignited is so hygroscopic that the porcelain boat should be placed within a weighing-beaker with ground-glass top immediately after removing it from the desiccator, and then weighed.

redness. At a dull red heat, the oxide is to be sure reduced to metal, but in such cases black, pyrophoric iron is formed and the latter cannot be exposed to the air and weighed without becoming oxidized. By heating to a bright red heat, however, the iron becomes gray, is no longer pyrophoric, and can, if allowed to cool in the stream of hydrogen, which is subsequently replaced by carbon dioxide, be safely weighed in the air without fear of oxidation.

Although this method is extremely simple, and the corresponding oxides of aluminium, chromium, titanium and zircon, etc., are not reduced under the same conditions, it should be used with caution and only when the ferric oxide greatly predominates in a mixture of oxides. Otherwise the reduction of the iron is incomplete on account of some of the ferric oxide being enclosed within the particles of foreign oxide. This has been proved by the work of Daniel and Leberle * and by Treadwell and Wegelin.†

It is still more accurate to dissolve the metallic iron produced in dilute sulphuric acid out of contact with the air and determining the amount present volumetrically by titrating with potassium permanganate solution.

3. Volumetric Determination of Iron, according to Margueritte.‡

Although the volumetric methods are discussed in the second part of this book, this determination is so important and is so often used to test the purity of the iron oxide produced by a gravimetric analysis that it seems proper to discuss it at this place.

Principle of the Method.

Ferrous salts are oxidized by potassium permanganate in acid solution to ferric salts:

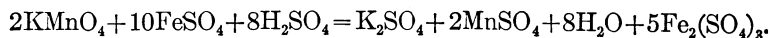

If, therefore, a potassium permanganate solution of known strength is slowly added to the solution of a ferrous salt, it will

* Z. anorg. Chem., **34**, 393 (1903).

† A table is given, showing the results of twelve experiments, in the German edition of this book.

‡ Ann. de chim. et de phys. [3], **18** (1846), p. 244.

be decolorized as long as there remains ferrous salt to react with it. As soon as all of the ferrous salt has been oxidized, the next drop of the permanganate will impart a permanent pink color to the solution, whereby the *end-point* of the reaction is determined.

Preparation and Standardization of the Permanganate Solution.

In most cases a $\frac{1}{10}$ normal solution of potassium permanganate is suitable, i.e. one which contains in one liter enough oxygen to oxidize $\frac{1}{10}$ of a gram-atom of hydrogen (1.008 gm. of hydrogen).

Potassium permanganate in acid solution reacts according to the equation

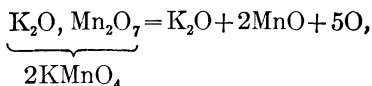

so that from two molecules of permanganate five atoms of oxygen (= 10 atoms of hydrogen) are available, thus:

$$\frac{2\text{KMnO}_4}{10} = \frac{\text{KMnO}_4}{5} = \frac{158.03}{5} = 31.61 \text{ gm. KMnO}_4 = \frac{1}{2} \text{ gm.-atom of oxygen} = 1 \text{ gm.-atom of hydrogen.}$$

Consequently it is necessary to take $\frac{1}{5}$ of a gram-molecule of potassium permanganate (3.161 gms.) for a liter of $\frac{1}{10}$ normal solution.

Although it is possible to purchase very pure potassium permanganate, it is not advisable to take the trouble of weighing out just this amount of the substance and dissolving it in exactly the right amount of water, for although we might in this way obtain the correct strength of solution, yet on the following day its value would be different, for the distilled water in which the permanganate is dissolved almost always contains traces of organic matter oxidizable by the permanganate. Consequently we weigh out on a watch-glass approximately the right amount of permanganate (3.1–3.2 gms.), dissolve it in a liter of water, and allow it to stand eight to fourteen days* before using it. After this time all of the oxidizable matter in the water will have been completely destroyed. The solution is filtered through an asbestos filter and then standardized.

* Cf. Morse, Hopkins, and Walker, Am. Chem. Jour., 18 (1896), p. 401.

Standardization of the Potassium Permanganate Solution.

It is possible to standardize the solution by a number of different methods, as will be discussed in detail under volumetric analysis.

In this case we are concerned with the determination of iron only, so that the most natural way for us to standardize the solution will be by means of chemically pure iron. An accurately weighed portion of iron is dissolved in dilute sulphuric acid out of contact with the air and permanganate solution is added from a glass-stoppered burette until the solution remains pink for one-half minute after thoroughly stirring or shaking.

If for the oxidation of a grams of iron t cubic centimeters of the permanganate solution were necessary, then

$$1 \text{ c.c.} = \frac{a}{t} \text{ gm. iron.}$$

The value $\frac{a}{t}$ represents the titration value of the solution.

Remarks.—The chief difficulty lies in the procuring of a suitable standard. It is difficult to prepare iron which is exactly 100 per cent. pure. Moreover, the purity of a sample of iron wire, such as is ordinarily used for standardization, cannot be determined satisfactorily by means of a gravimetric analysis because the analytical errors are greater than is usually supposed. The ferric hydroxide precipitate is bulky so that it is customary to take only about 0.2 gm. of wire for analysis which yields approximately 0.283 gm. of Fe_2O_3 so that an error of 0.0003 gm. in the final weight corresponds to 0.1 per cent. of iron in the sample. The precipitate of ferric hydroxide, moreover, often contains silica and alumina when the analysis is carried out in glass beakers, or when the reagents used have been in contact with glass for some time. This leads to *high* results and the error may amount to 0.003 gm. Again, in igniting a precipitate of hydrated ferric oxide great care must be taken or some of it will be reduced to magnetite as can be shown by a magnet held outside the crucible.*

*The carbon from the filter-paper causes the reduction when the precipitate and filter are heated together and too much heat is used at the start. Heating the covered crucible over the blast lamp also converts Fe_2O_3 into Fe_3O_4 .

When magnetite is thus once formed it is practically impossible to change it back to ferric oxide by further heating or by treating the precipitate with concentrated nitric acid. This leads to *low* results. When thrown down from hydrochloric acid solutions by the addition of ammonia, the precipitate often contains some chloride which it is hard to remove by washing, and on igniting such a precipitate there is danger of losing a little ferric chloride by volatilization. On account of these sources of error it is difficult to carry out a perfect gravimetric estimation of iron with an accuracy sufficient for standardization purposes. The most satisfactory method is to determine the impurities present, but even although this may give the correct percentage of iron, if there is any carbon, phosphorus, silicon or sulphur present, as is usually the case, compounds may be left in solution which are oxidizable by potassium permanganate so that a sample of iron wire may show against permanganate an apparent iron value of from 100 to 101 per cent., in spite of the fact that it contains only 99.7 per cent. of pure iron.

A. Classen * has proposed, therefore, to standardize potassium permanganate against pure electrolytic iron and in the author's laboratory this has been found to be very satisfactory. There is a possibility, however, of such electrolytic iron containing occluded hydrogen, carbon, etc., which may exert some effect upon the titration, although when the electrolysis is properly carried out, these errors cannot be large. G. Lunge, in his report to the Sixth International Congress of Applied Chemists † (Rome, 1907), recommended that permanganate should be standardized against one of four substances:

(1) Pure oxalic acid, the exact value of which has been determined by titration against standard barium hydroxide solution. The barium hydroxide is standardized against hydrochloric acid, which is in turn titrated against sodium carbonate. (See Acidimetry.)

* Mohr-Classen, Lehrbuch der chem.-analyt. Titriermethode (1896).

† See also Z. Angew. Chem. 17, 195 (1904).

- (2) Pure iron wire, the exact value of which is known by a comparison with oxalic acid (standardized as above).
- (3) Sodium oxalate. (See Acidimetry.)
- (4) Hydrogen peroxide by the Nitrometer Method.

Preparation of Electrolytic Iron.

Some commercial ferrous chloride is dissolved in water and a little hydrochloric acid, the solution is saturated with hydrogen sulphide, and filtered. After boiling off the excess of hydrogen sulphide, the ferrous chloride is oxidized by means of potassium

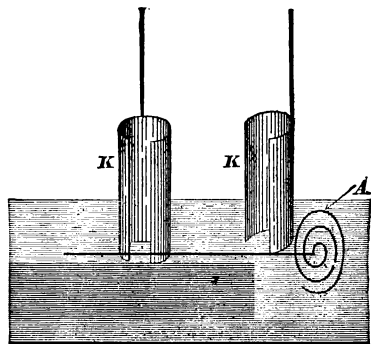

FIG. 27.

chlorate and hydrochloric acid, the excess of chlorine boiled off, and the solution neutralized by the careful addition of sodium hydroxide. The iron is then precipitated by the barium carbonate method (see p. 149). The well-washed precipitate is dissolved in hot, dilute hydrochloric acid and freed from barium by a double precipitation of the iron with ammonia. The hydrated ferric oxide thus obtained is dried, ignited, and reduced to metal in a stream of hydrogen as described on p. 88. The metallic iron is dissolved in the calculated amount of dilute sulphuric acid out of contact with the air (passing CO_2 through the solution*). The

* For the generation of carbon dioxide, an apparatus similar to that shown in Fig. 30 is used, only the wash-bottle *A* is filled with permanganate solution, and the tower *C* contains pumice soaked with copper sulphate solution, above which is a plug of cotton.

The potassium permanganate and copper sulphate both serve to remove H_2S from the CO_2 .

solution is then diluted with water until 20 c.c. contain about 0.35 gm. iron.

In addition it is also necessary to provide a solution of ammonium oxalate, saturated at the room temperature.

For the electrolysis, two electrodes *K* (Fig. 27) are prepared by taking two pieces of platinum-foil about 25 sq. cm. surface and

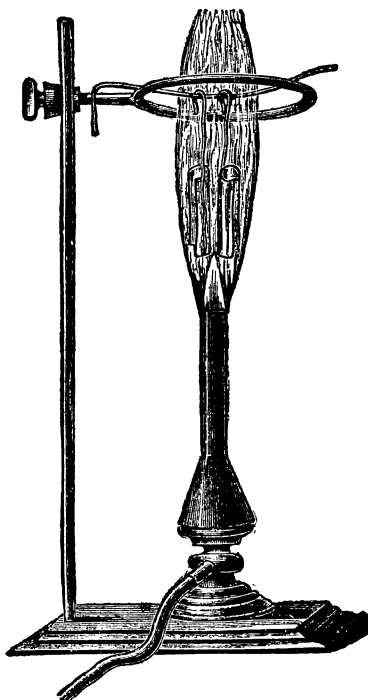

FIG. 28.

fastening a piece of fairly heavy platinum wire to each; they are bent so that they will conveniently pass through the neck of a liter-flask. The electrodes are cleaned by boiling in concentrated hydrochloric acid and finally igniting them over the free flame. To accomplish the latter purpose, it is convenient to hang them upon a heavy platinum wire which is itself placed

on an iron ring; they are then heated over the non-luminous flame of the Teclu burner (Fig. 28).*

After the ignition the electrodes are allowed to cool in a desiccator and weighed accurately by the method of swings (cf. p. 10). About 350 c.c. of the ammonium oxalate solution are now placed in a 400-c.c. beaker and 20 c.c. of the iron solution (about 0.35 gm. Fe) are added. The beaker is covered with a glass plate containing three holes (Fig. 29). At the ends of the plate are fastened two corks which serve to support the two heavy platinum wires *a* and *b*. Through the two side holes are passed from below the bent platinum wires of the

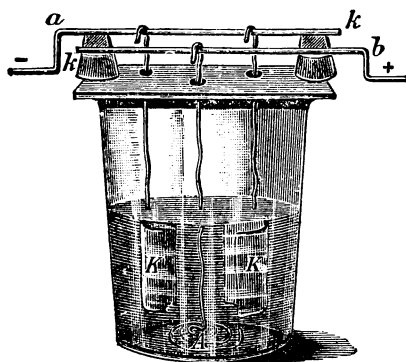

FIG. 29.

cathodes *K*, leaving them suspended from *a*; while through the middle hole the end of the spiral anode passes and is suspended from the cross-wire *b*. The wire *a* is now connected with the negative, and wire *b* with the positive pole of a battery, and the solution is electrolyzed for from one and one-half to two hours at about 69° with a current of 0.5–0.7 ampere. At the end of this time there will be firmly attached to each of the cathodes about 0.15–0.17 gm. of a bright, steel-gray deposit. The circuit is broken, one of the electrodes is removed, and

* The electrodes must be above the inner flame mantle. They should never be heated in this way when a deposit is upon them: The deposit is likely to be oxidized and in many cases the platinum will be alloyed. It is safer in all cases to dry the electrodes in a drying oven.

the circuit again closed. The electrode which has been removed is at once plunged into a beaker of distilled water, taken out, the bottom edge touched with a piece of filter-paper to remove the greater part of the adhering water, and then washed with a liberal quantity of absolute alcohol that has been distilled over lime. The lower edge is again touched with filter-paper, then washed with ether which has been distilled over potash, after which it is dried in the hot closet until the ether has evaporated (this takes about half a minute). It is then placed in a desiccator. The second electrode is now removed from the circuit and subjected to precisely the same treatment. After the electrodes have been in the desiccator for fifteen minutes they are weighed.

While the solution is being electrolyzed the solvent for the iron should be prepared. In the liter-flask *K* (Fig. 30) are placed 500 c.c. of water and 50 c.c. of chemically pure concentrated sulphuric acid. The contents of the flask are heated to boiling, meanwhile passing a stream of carbon dioxide through the liquid. After the latter has boiled vigorously for ten minutes the flask is closed at *b*, removed from the flame, placed in cold water, and allowed to cool in an atmosphere of carbon dioxide.

In this manner a solution of sulphuric acid is obtained completely free from air, so that there is no danger of its oxidizing any of the ferrous salt.

One of the weighed electrodes, on which the iron has been deposited, is thrown into the flask containing the sulphuric acid; the flask is immediately closed and gently heated on the water-bath, or better to boiling, still passing carbon dioxide through the apparatus. The iron dissolves very quickly, leaving no residue.* The flask is then closed at *b*, placed in cold water, and titrated with permanganate solution added from a glass-stoppered burette. After noting the burette reading, the permanganate is added drop by drop and the flask is constantly rotated to insure thorough mixing of the permanganate with the ferrous solution. When the solution possesses a slight pink color, permanent for half a minute, the

* Sometimes a minute trace of carbon remains undissolved, but it is so small in amount that it can safely be disregarded.

† See under Volumetric Analysis.

end-point is reached, and after the burette has drained a second reading is taken. A blank test is made with another portion of

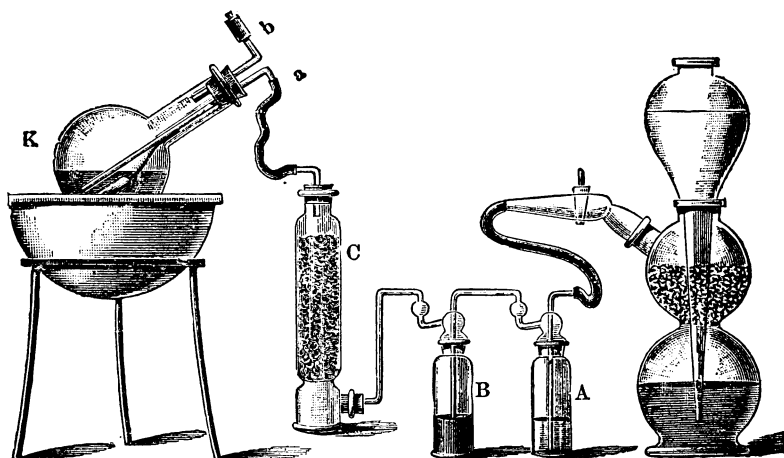

FIG. 30.

500 c.c. of water and 50 c.c. sulphuric acid solution (boiled free from air in the same way and allowed to cool in a stream of carbon dioxide), to see how much permanganate is necessary to impart this pink color in the absence of iron. This amount should be subtracted from the total number of cubic centimeters of the permanganate solution used in titrating the iron.

The results obtained by this procedure are excellent.

After the strength of the permanganate solution has been accurately determined by the above method the apparent iron value of a sample of iron wire may be determined. When this is known it is possible to determine accurately the strength of a new permanganate solution, or of the same solution at a future date, by titrating against a solution of the same wire.

‡ Thus Dr. Schudl obtained the following values by using three methods:

- 1 c.c. KMnO_4 = 0.005485 g. Fe with electrolytic iron;
- 1 c.c. " = 0.005470 g. " " iodine;
- 1 c.c. " = 0.005468 g. " " oxalic acid.

Determination of the Apparent Iron Value of Iron Wire.

The wire is cleaned by rubbing with a piece of emery paper until it is perfectly bright. It is then passed through filter-paper until it no longer leaves a gray mark on the paper. The wire is wound round a dry glass rod, making a spiral, and a portion of 0.15–0.2 gm. is weighed out. This is dissolved, as described on p. 601, in a flask which is fitted with a Bunsen valve* and contains 55 c.c. of dilute sulphuric acid (50 c.c. water + 5 c.c. conc. H_2SO_4); the solution is boiled † a few minutes after the iron has all dissolved. It is allowed to cool, and is then titrated with permanganate which has been standardized against electrolytic iron or sodium oxalate. The apparent iron value of the wire is then calculated.

Every time a new supply of iron wire is obtained its apparent iron value should be determined.

The following results of determinations made with great care by W. A. K. Christie in the author's laboratory illustrate the process:

The permanganate solution was standardized against iron wire and it was found that 1 c.c. = 0.005600 gm. iron. The purity of the sample of commercial iron wire was found in three titrations to be 99.93, 100.0 and 99.92 per cent., the average of which is 99.94 per cent. The actual purity of the wire was determined to be 99.7 per cent. The apparent purity, therefore, is greater than the actual purity, and if the latter were to be used in the computation the permanganate solution would be found a little too strong.

The author recommends the standardization against electrolytic iron and compares the value obtained with that found with iron wire, the work all being done on the same day. Then the apparent iron value of the wire will be known for future

* Still better is the use of the glass valve as recommended by Contat (*Chem. Ztg.*, 1898, 298) and improved by Göckel (*Z. Angew. Chem.*, 1899, 620). When the boiling is stopped, sodium bicarbonate is sucked back into the solution, and there is no overpressure on the outside. Cf. p. 601.

† The boiling of the solution is necessary, as otherwise hydrocarbons or other reducing substances remain in solution so that too much permanganate is used

standardizations and it will be necessary to standardize against electrolytic iron only when a new supply of iron is purchased. On the other hand, it must be admitted that the standardization against sodium oxalate is full as accurate and is easier to carry out. See Volumetric Analysis, p. 597.

Analysis of Ferric Compounds according to the Method of Margueritte.

From what has already been said, it is evident that in order to determine the amount of iron present in a solution by titration with potassium permanganate, it is necessary for the iron to be present entirely in the ferrous condition. In order, therefore, to apply this method to the analysis of ferric compounds, it is first necessary to reduce them completely.

To effect the reduction of a ferric sulphate solution we can proceed as follows: The solution is placed in a 200-c.c. flask, acidified with one-tenth its volume of pure, concentrated sulphuric acid, the flask is closed with a stopper provided with two tubes through which gas can enter and leave the flask, the contents of the flask are heated to boiling and hydrogen sulphide is passed through the solution until it is perfectly colorless. The boiling is continued and carbon dioxide is now passed through the solution until the excess of hydrogen sulphide is completely removed. The solution is then allowed to cool in an atmosphere of carbon dioxide and titrated exactly as in the standardization of the solution of permanganate.

If t c.c. of permanganate were necessary to completely oxidize the solution and 1 c.c. of the permanganate corresponds to a gm. of iron, then the titrated solution evidently contains $a \cdot t$ gm. of iron.

Besides hydrogen sulphide, a great many other substances can be used to reduce the ferric salt, e.g., zinc, sulphurous acid, stannous chloride. The use of these substances will be discussed in the portion of this book devoted to Volumetric Analysis.

Remark.—The titration of a solution by means of potassium permanganate takes place preferably in a sulphuric acid solution; in the case of hydrochloric acid too high results will be obtained

(due to the fact that the permanganate oxidizes some of the acid), unless the oxidation takes place in a dilute solution in the presence of a large excess of manganous sulphate. See Volumetric Analysis.

TITANIUM, Ti. At. Wt. 48.1.

Titanium, when present in large amounts, is determined as its dioxide, TiO_2 ; but if only small amounts are to be determined, as in the case of many rocks and iron ores, the colorimetric method is preferable.

(a) Determination as Titanium Dioxide.

The titanium is precipitated from solution either by means of ammonia, or by boiling a solution strongly acid with acetic acid and containing considerable ammonium acetate; or, finally, by boiling the slightly acid solution of the sulphate. In all these cases it is precipitated as titanous acid, from which it is changed by ignition into TiO_2 .

The two former methods are preferable to the third. See separation of titanium from aluminium.

(b) Determination of Titanium Colorimetrically; Method of A. Weller.*

(Suitable for small amounts of titanium.)

This determination depends upon the fact that acid solutions of titanium sulphate are colored intensely yellow when treated with hydrogen peroxide; the yellow color increases with the amount of titanium present and is not altered by an excess of hydrogen peroxide. On the other hand, inaccurate results are obtained in the presence of hydrofluoric acid (Hillebrand); consequently it is not permissible to use hydrogen peroxide for this determination which has been prepared from barium peroxide by means of hydrofluosilicic acid. Furthermore, chromic, vanadic, and molybdic acids must not be present, since they also give colorations with hydrogen peroxide. The presence of small amounts of iron does not affect the reaction, but large amounts of iron cause trouble on account of the color of the iron solution. If, however, phosphoric acid is added to the colored ferric solution it becomes

* Berichte, 15, p. 2593.

decolorized, and from such a solution the determination of titanium offers no difficulty. The solution in which the titanium is to be determined must contain at least 5 per cent. of sulphuric acid; an excess does not influence the reaction. The reaction is so delicate that 0.00005 gm. of TiO_2 present as sulphate in 50 c.c. of solution give a distinctly visible yellow coloration.

For this determination a standard solution of titanium sulphate is required. This can be prepared by taking 0.6000 gm. of potassium titanate fluoride which has been several times recrystallized and gently ignited (corresponding to 0.2 gm. of TiO_2). This is treated in a platinum crucible several times with a little water and concentrated sulphuric acid, expelling the excess of acid by gentle ignition, finally dissolving in a little concentrated sulphuric acid and diluting with 5 per cent. sulphuric acid to 100 c.c. One cubic centimeter of this solution corresponds to 0.002 gm. TiO_2 .

The determination proper is carried out in the same way as described on p. 60, under the colorimetric determination of ammonium.

50 c.c. of the solution which has been brought to a definite and accurately measured volume is placed in a Nessler tube beside a series of other tubes, each containing a known amount of the standard titanium solution, filled up to the mark with water and each treated with 2 c.c. of 3 per cent. hydrogen peroxide* (free from hydrofluoric acid). The color of the solution in question is compared with the standards. This method is only suitable for the estimation of small amounts of titanium, as the shades of strongly colored solutions cannot be compared accurately.

According to J. H. Walton, Jr.,† titanium in the presence of iron may be determined after fusing the finely powdered substance with two or three times as much sodium peroxide. On extracting with water, sodium pertitanate goes into solution and ferric oxide is left behind. The filtered solution is acidified with sulphuric acid, which is added until 5 per cent. of free acid is

* The hydrogen peroxide solution is prepared shortly before using by dissolving commercial potassium percarbonate in dilute sulphuric acid.

† J. Am. Chem. Soc., 29, 481 (1907).

present. The color of the solution is then compared with that obtained by fusing a known weight of TiO_2 with Na_2O_2 , etc.

CHROMIUM, Cr. At. Wt. 52.1.

Forms: **Chromic Oxide, Cr_2O_3 ; Barium Chromate, BaCrO_4 .**

(a) Chromic Compounds.

Determination as Chromic Oxide.

1. By Precipitation with Ammonia or Ammonium Sulphide.

If the chromium is present in solution as chromic compound it can be precipitated exactly as described under aluminium, by means of a slightest possible excess of ammonia* in the presence of considerable ammonium salts (or better still, by the addition of freshly prepared ammonium sulphide solution to the boiling solution). The precipitated $\text{Cr}(\text{OH})_3$ is washed with dilute ammonium nitrate solution and ignited wet in a platinum crucible, being thereby changed to the oxide, Cr_2O_3 . The results obtained are always a few tenths of a per cent. too high on account of the formation of small amounts of alkali chromate even though the entire operation takes place in platinum vessels. The alkali comes from the reagents. It can be shown that the ignited product contains a little chromate, as the aqueous extraction always possesses a slight yellow color and gives with silver nitrate a red precipitate of silver chromate.

If phosphoric acid is present, it will be found in the precipitate. In this case the dried precipitate is fused in a platinum crucible with sodium carbonate and potassium nitrate, whereby sodium chromate and sodium phosphate are obtained. The melt is dissolved in water, acidified with nitric acid, and the phosphoric acid precipitated by means of ammonia and magnesia mixture, as described under Phosphoric Acid. From the filtrate the chromium is determined as barium chromate in acetic acid solution as described below.

* An excess of ammonia prevents the complete precipitation of the chromium hydroxide, the filtrate is then colored pink. In such cases the filtrate must be boiled until the excess of ammonia is expelled, and the chromium is all precipitated.

2. *By Precipitation with Potassium Iodide—Iodate Solution.*
*Method of Stock and Massaciu.**

The determination is carried out as in the case of aluminium (cf. p. 83). The slightly acid † solution, contained in a porcelain dish, is treated with a mixture of potassium iodide and iodate, decolorized after a few minutes by means of sodium thiosulphate solution, treated with a little more iodide and iodate and then again with a few c.c. of sodium thiosulphate, and heated half an hour on the water-bath. The flocculent precipitate of chromic hydroxide settles quickly, and is filtered preferably through a hot water filter under slight suction. The precipitate is ignited wet in a platinum crucible.

3. *By Precipitation with Ammonium Nitrite.‡*

If the solution of the chromic salt is acid, it is neutralized with ammonia until a slight permanent precipitate is obtained. This precipitate is dissolved by the addition of a few drops of hydrochloric acid and then an excess of 6 per cent. ammonium nitrite solution is added and the liquid boiled until all nitrous fumes have been expelled. By this means practically all of the chromium will have been precipitated, but in order to throw down the last traces, ammonia is added drop by drop until the odor of free ammonia barely persists in the solution. The precipitate is allowed to settle while the beaker remains on the water-bath, and is finally filtered off, washed with hot water, ignited wet in a platinum crucible, and weighed as Cr_2O_3 .

(b) *Chromates.*

If the chromium is present in solution in the form of an alkali chromate, free from chloride and large amounts of sulphuric acid,

* Ber., 1901, 467.

† If the solution is strongly acid, it is neutralized by the addition of pure KOH solution drop by drop, until a faint permanent turbidity is obtained.

‡ E. Schirm, Chem. Ztg., 1909, 877. Cf. p. 111. According to Scholler and Schrauth (*ibid.*, 1909, 1287) iron, chromium, aluminium, and zinc can be precipitated by means of aniline.

it may be determined very accurately by precipitation with mercurous nitrate solution as mercurous chromate; on ignition the latter is changed to Cr_2O_3 .

Procedure.—The neutral or weakly acid solution is treated with a solution of pure mercurous nitrate whereby brown, basic mercurous chromate, $(4\text{Hg}_2\text{O}\cdot 3\text{CrO}_3)$, is formed. On heating to boiling, the precipitate becomes a beautiful, fiery red, being converted into the neutral salt Hg_2CrO_4 . This red salt settles very quickly, and if the precipitation is complete the solution above the precipitate will be colorless. After cooling, the precipitate is filtered off, washed thoroughly with water containing a little mercurous nitrate, dried and separated from the filter as completely as possible. The filter is burned in a platinum spiral and ignited with the main portion of the precipitate, gently at first and finally strongly, in a platinum crucible under a hood with a good draft, afterwards weighing the residue as Cr_2O_3 .

The purity of the mercurous nitrate must be tested before using it. 5 gms. of the salt should leave no residue after being ignited.

This excellent method for the determination of chromium unfortunately permits only a very limited application. If the solution contains any considerable amount of chloride, mercurous chloride will be precipitated with the mercurous chromate, which, although volatile on ignition, renders the precipitate too bulky and the method inaccurate.

If, therefore, it is necessary to determine chromium present as chromate in a solution containing chloride, two other methods are at our disposal. The chromate may be reduced by boiling with sulphurous acid (or by evaporating with concentrated hydrochloric acid and alcohol) and analyzed according to (a), or it may just as accurately, and much more conveniently, be determined by precipitating as

Barium Chromate,

which is weighed after gentle ignition.

Procedure.—The neutral solution, or one weakly acid with acetic acid, is treated at the boiling temperature with a solution of barium acetate added drop by drop,* and after standing for some time,

* If the barium acetate solution is added too quickly some of it will be

is filtered through a Gooch crucible (without using very strong suction, as otherwise the filter will soon get stopped up and the solution will filter extremely slowly). The precipitate is washed with dilute alcohol and dried in the hot closet. The crucible is suspended in a larger one of porcelain by means of an asbestos ring (cf. page 27) and heated, at first gently, and finally over the full flame of a good Bunsen burner. After five minutes the cover is removed and the heating is continued until the precipitate appears a uniform yellow throughout, when it is cooled in a desiccator and weighed.

Sometimes the precipitate appears green on the sides of the crucible owing to a slight reduction (by means of dust, traces of alcohol, etc.) of chromic acid to chromic oxide. The latter gradually takes on oxygen from the air during the long-continued heating of the open crucible, so that the green color gradually disappears.

If a grams of chromate were taken for analysis, and the barium chromate precipitate weighed p grams, then the amount of chromium present may be calculated as follows:

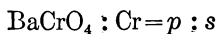

$$s = \frac{\text{Cr}}{\text{BaCrO}_4} \cdot p,$$

and

$$a : \frac{\text{Cr}}{\text{BaCrO}_4} \cdot p = 100 : x,$$

$$x = \frac{100 \text{ Cr}}{\text{BaCrO}_4} \cdot \frac{p}{a} = \text{per cent. Cr.}$$

Example for practice: Potassium bichromate, $\text{K}_2\text{Cr}_2\text{O}_7$, purified and dried as described on pages 33 and 35.

Chromium originally present as chromate, or obtained as such after suitable oxidizing treatment, may be determined accurately by volumetric methods described in Part II.

carried down with the barium chromate, so that too high results will be obtained.

URANIUM, U. At. Wt., 238.5.Forms: U_3O_8 and UO_2 .*(a) Determination as U_3O_8 .*

Uranium is almost always precipitated by means of ammonia as ammonium uranate and changed to U_3O_8 by gentle ignition in a platinum crucible with free access of air. According to Zimmerman* this transformation is only complete when the precipitate is ignited in a stream of oxygen; the error is, however, so small that for ordinary purposes it can be neglected.

According to the temperature of ignition, the U_3O_8 appears dirty green or black, and is difficultly soluble in dilute hydrochloric or sulphuric acids; in nitric acid it dissolves gradually. By heating with dilute sulphuric acid (1 vol. conc. $H_2SO_4 + 6$ vol. H_2O) in a closed tube at 150° – 175° C. for a long time (W. F. Hillebrand),† the U_3O_8 is completely dissolved with the formation of uranous and uranyl sulphate:

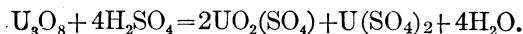

U_3O_8 is also readily soluble in dilute sulphuric acid in the presence of potassium bichromate. These two last facts are taken advantage of in the volumetric determination of uranium (which see).

(b) Determination as UO_2 .

The ignited precipitate, obtained in exactly the same way as before, is heated over a good Teclu burner, or over the blast-lamp, in a current of hydrogen, until a constant weight is obtained whereby it is quantitatively changed to UO_2 . This is the most accurate method for the determination of uranium.

The UO_2 thus obtained is a brown powder, insoluble in dilute hydrochloric and sulphuric acids, but soluble in concentrated sulphuric acid after long heating, best in a closed tube. This oxide is also soluble in nitric acid.

* Ann. d. Ch. und Ph., 232 (1886), p. 287.

† Bull. U. S. Geol. Survey, 78, p. 90.

Separation of Iron, Aluminium, Chromium, Titanium, and Uranium from Calcium, Strontium, Barium, and Magnesium.

The solution containing the above substances in the presence of considerable ammonium chloride is placed in an Erlenmeyer flask and treated with a slight excess of freshly prepared ammonium sulphide free from sulphate and carbonate. After standing overnight the precipitate is filtered off and washed with water containing ammonium sulphide. It contains the iron and uranium as sulphides, the aluminium, chromium, and titanium as hydroxides. In case large amounts of magnesium are present, some of it is almost always present in the precipitate, so that it is then necessary to dissolve the precipitate, after filtration, in hydrochloric acid and to reprecipitate with ammonium sulphide.

Instead of using ammonium sulphide, the separation can be accomplished satisfactorily with ammonia; the iron must then be in the ferric condition.

Separation of Iron from Aluminium.

(1) The solution is treated in a porcelain dish with pure potassium hydroxide solution until strongly alkaline, boiled, diluted with hot water, and filtered. The precipitate contains the iron as hydroxide, while the solution contains the aluminium as aluminate.* For the iron determination the precipitate is dissolved in hydrochloric acid, reprecipitated with ammonia,† dried, and weighed as Fe_2O_3 (see page 83). The aluminium is precipitated as hydroxide from the filtrate by acidifying with nitric acid and then adding ammonia.

(2) The acid solution is treated with tartaric acid (three parts of tartaric acid for each part of the mixed oxides ($\text{Fe}_2\text{O}_3 + \text{Al}_2\text{O}_3$)), hydrogen sulphide is passed into the solution until it is saturated, as slight an excess as possible of ammonia is added, and the sulphide of iron is allowed to settle in a closed Erlenmeyer flask. It is then

* If the precipitate is large, it should be dissolved in hydrochloric acid and again precipitated with KOH.

† It is very hard to wash the KOH precipitate free from alkali so that the first precipitate should not be weighed.

filtered, washed with water containing ammonium sulphide, dissolved in hydrochloric acid, oxidized with a little potassium chlorate or nitric acid, and precipitated as ferric hydroxide by the addition of ammonia. The aluminium is determined in the filtrate by evaporating to dryness with the addition of a little sodium carbonate and potassium nitrate. The residue is gently ignited in a platinum dish in order to destroy the tartaric acid, after which it is dissolved in dilute nitric acid, the carbon filtered off, and the aluminium precipitated from the solution by the addition of ammonia.

(3) The neutral solution of the chlorides or sulphates (not the nitrates) is treated with sodium carbonate until a slight permanent precipitate is formed, which is dissolved by the addition of a few drops of hydrochloric acid. The solution is diluted to about 250 c.c. for each 0.1 or 0.2 gm. of the metals present, an excess of sodium thiosulphate solution is added, and the solution boiled until every trace of SO_2 has disappeared. By this operation the ferric salt is reduced to ferrous salt:

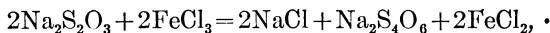

and the aluminium is precipitated as the hydroxide:

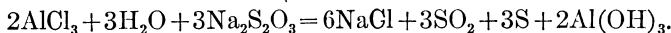

The precipitate of aluminium hydroxide and sulphur is filtered off, washed with hot water, dried, transferred as completely as possible to a porcelain crucible, the filter burned in a platinum spiral and the ash added to the crucible, which is ignited gently until all the sulphur has been expelled and then more strongly over the blast or a Teclu burner until the weight is constant.

To determine the iron, the filtrate may be acidified with hydrochloric acid, the SO_2 boiled off, the sulphur filtered off, the solution oxidized with nitric acid and precipitated by ammonia as described on page 87. It is still better to precipitate the iron with ammonium sulphide, filter, dissolve in hydrochloric acid, oxidize with nitric acid, and then precipitate with ammonia.

(4) Both of the metals are precipitated with ammonia, filtered, washed, dried, ignited in a platinum crucible, and the weight of the combined oxides determined. The mixture is then digested with concentrated hydrochloric acid to which a little water has been added (10HCl:1H₂O) in a covered crucible until the iron is completely dissolved. If ferric oxide predominates, as is frequently the case, the solution is effected in one or two hours. If, on the other hand, a relatively large amount of alumina is present (as is usually the case with silicates), and which can be detected by the color of the precipitate produced by ammonia, the precipitate then dissolves very slowly and in many cases only incompletely.

In the latter case the ignited oxides are brought into solution by fusing with 12–15 times as much potassium pyrosulphate, K₂S₂O₇ (cf. Vol. I).^{*} The decomposition of the oxides is usually complete in 2–4 hours. The crucible together with its cover is placed in a beaker, water and a little sulphuric acid are added, and the melt is dissolved by warming gently, and passing a current of air through the solution in order to keep the liquid in motion. A small amount of platinum is always dissolved by this treatment. After removing the crucible and its cover, the solution is heated to boiling and saturated with hydrogen sulphide. The solution is then filtered into a flask and carbon dioxide is passed through it until the excess of hydrogen sulphide is completely removed. The contents of the flask are then cooled by placing the flask in cold water, the carbon dioxide still passing through the flask. The iron is then titrated with potassium permanganate solution as described on page 99. The aluminium is determined by difference, from the weight of the combined oxides. For the determination of iron in silicates the above process is most suitable (Hillebrand). The reduction of the ferric salt to ferrous salt by means of hydrogen sulphide possesses great advantages over the reduction by means of zinc, for in the former case no foreign element is introduced, and furthermore zinc serves to reduce the titanate acid

^{*} E. Deussen finds that fusion with KF.HF works better. The platinum is not attached and the solution is effected more readily.—Z. angew. Chem., 1905, 815.

that is almost always present in rocks, and this will be again oxidized by the permanganate, so that too high an iron value will be obtained.

If the iron is all dissolved by treating the oxides with hydrochloric acid, the solution is evaporated to dryness and the residue is treated with a few cubic centimeters of dilute sulphuric acid, evaporated on the water-bath as far as possible, and then heated over the free flame until fumes of sulphuric acid are evolved. After cooling, the product is dissolved in water and the ferric sulphate reduced to ferrous sulphate by introducing a piece of zinc, free from iron, into the crucible and covering the latter with a watch-glass.* The reduction is complete in 20–30 minutes. The slight residue of platinum † is filtered off with the excess of zinc into a flask already filled with carbon dioxide. The residue is washed with water that has been boiled, and the solution is titrated with potassium permanganate solution.

The latter method is to be recommended for the determination of small amounts of iron in the presence of still less aluminium, as is the case in the analysis of mineral waters.

The following procedure leads to the same end, but the results are not quite so reliable:

The solution from which the iron and aluminium are to be determined is diluted to a definite volume (e.g., 250 c.c.) and two aliquot portions are taken by means of a pipette (usually 100 c.c.).

In one portion the weight of the combined oxides of iron and aluminium is determined by precipitation with ammonia and ignition of the precipitate, while in the other the iron is determined by titration. If the solution contains hydrochloric acid, as is usually the case, the iron is first precipitated with ammonia, filtered,

* If titanium is present, the solution is reduced by means of hydrogen sulphide.

† Platinum is perceptibly attacked by long digestion with ferric chloride solution:

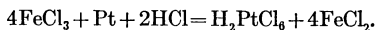

The chloroplatinic acid is reduced to platinum by the action of zinc.

washed, and dissolved in dilute sulphuric acid. The solution is then reduced and titrated as previously described.*

Separation of Iron, Aluminium, and Phosphoric Acid.

Although the determination of phosphoric acid has not yet been considered, we will describe its determination in the presence of iron and aluminium because this highly important separation is necessary in the analysis of almost all minerals containing iron and aluminium as well as in the analysis of many mineral waters. Two cases are to be distinguished:

1. The solution contains only a small amount (a few centigrams or less) of iron, aluminium, and phosphoric acid.

2. The solution contains large amounts of these substances.

1. In the first case the determination of all three constituents must be undertaken in the same portion, as otherwise errors would be introduced on account of the small amounts to be determined. The solution is first treated with ammonia whereby the iron, aluminium and phosphoric acid are precipitated.†

The precipitate is ignited in a platinum crucible and weighed:

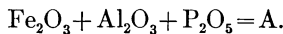

The product is then fused with six times its weight of a mixture consisting of four parts anhydrous sodium carbonate and one part pure silica. The mixture is heated over the blast-lamp, the melt is extracted with water, to which a little ammonium carbonate has been added, and filtered. The filtrate contains all of the phosphoric acid and a very little silicic acid, while the residue contains all of the iron and aluminium and considerable silica.

For the determination of the phosphoric acid, the filtrate is evaporated with hydrochloric acid on the water-bath to dryness,

* It is necessary to get rid of the hydrochloric acid on account of its action upon potassium permanganate (cf. Vol. Anal., under Iron).

† The phosphoric acid is usually present in such small amounts that the iron and aluminium are more than sufficient to effect the precipitation of all the phosphoric acid, on the addition of ammonia, as phosphates of these metals.

in order to remove the silica, the residue is moistened with hydrochloric acid, taken up in a little water, filtered, and the phosphoric acid precipitated in the filtrate by the addition of ammonia and "magnesia mixture." The precipitate of magnesium ammonium phosphate is changed to magnesium pyrophosphate by ignition and from its weight p the amount of phosphoric anhydride, P_2O_5 , is calculated ($=B$):

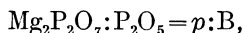

$$B = \frac{P_2O_5}{Mg_2P_2O_7} \cdot p.$$

By subtracting B from A the combined weight of the iron and aluminium oxides is obtained, in which the iron is determined volumetrically and the aluminium by difference. For the determination of the iron, the insoluble residue, obtained after treating the product of the fusion with water and ammonium carbonate, is digested with hydrochloric acid in a small porcelain crucible until the iron oxide is completely dissolved. The solution is treated with dilute sulphuric acid, evaporated on the water-bath as far as possible, and then over a free flame until fumes of sulphuric anhydride are evolved. After cooling, water is added and after digesting on the water-bath for a long time the silica is filtered off, the solution reduced by means of hydrogen sulphide (cf. p. 109, sub. 4), and, after removing the excess of hydrogen sulphide, the iron is titrated with permanganate solution.* From the amount of permanganate used, the amount of ferric oxide (C) can be calculated, and by deducting this amount from the weight of the combined oxides, the weight of the Al_2O_3 is ascertained:

$$A - (B + C) = Al_2O_3.$$

2. In case the solution contains large amounts of iron, aluminium, and phosphoric acid, it is divided into three aliquot portions and in one the value of "A" is determined by precipitation with ammonia; in the second the phosphoric acid is determined by the molybdate method; and in the third the iron is determined by titration.

* Instead of reducing the iron, the ferric salt may be titrated directly with titanous chloride (cf. p. 699), or iodometrically (cf. p. 681).

Separation of Iron from Chromium.

1. The chromium is oxidized in alkaline solution by means of chlorine, bromine or sodium peroxide to a soluble chromate, and the insoluble ferric hydroxide is filtered off.

Procedure.—The solution of the chlorides, which should be placed in an Erlenmeyer flask of Jena glass provided with a ground-glass stopper and tubes by which gas may enter and leave the flask, is treated with potassium hydroxide solution until strongly alkaline, warmed on the water-bath and chlorine gas is conducted through the liquid, or bromine water is added, until it becomes distinctly yellow and the ferric hydroxide has assumed its characteristic reddish-brown color. When the oxidation is performed by chlorine gas, 0.5 gm. of the mixed oxides will be completely oxidized in fifteen to twenty minutes. The solution is diluted with water and filtered. The filtrate is carefully acidified with acetic acid, the chromium precipitated by the addition of barium acetate, and the precipitate of barium chromate is treated as described on p. 104. The ferric hydroxide is dissolved in hydrochloric acid, reprecipitated with ammonia and weighed as ferric oxide.

Remark.—If the chromate is to be determined as barium chromate, the solution must contain no sulphuric acid. If the latter is present, the chromate is reduced by evaporating with hydrochloric acid and alcohol; the solution of chromic chloride thus obtained is precipitated with ammonia and the chromium determined as chromic oxide.

In the case of a precipitate containing iron and chromic oxides, it is fused with sodium carbonate and a little potassium chlorate, the melt is extracted with water, and the chromium is determined in the solution by precipitating with barium acetate. The insoluble residue from the aqueous extraction of the fusion is dissolved in hydrochloric acid, precipitated with ammonia, and the iron determined as ferric oxide.

If it is desired to precipitate the chromium as mercurous chromate, the precipitate containing the iron and chromic oxides is fused with sodium carbonate and potassium nitrate, the melt

extracted with water, the solution neutralized with nitric acid and precipitated with mercurous nitrate solution, as described on p. 104.

2. It has been proposed to analyze the mixture of ferric and chromic oxides by strongly igniting them in a stream of hydrogen whereby the ferric oxide is reduced to metallic iron, while the chromic oxide is unchanged. The iron could then be determined by the loss of weight. This method, although theoretically very simple, seems from experiments carried out in the author's laboratory to be absolutely inadequate, for the ferric oxide is so enveloped in chromic oxide that it is not even approximately reduced even when heated over the blast-lamp.

3. Iron may be separated from chromium by precipitating the former with ammonium sulphide from a solution containing sufficient ammonium tartrate to prevent the precipitation of the chromium. The separation is the same as was described under aluminium, p. 107, sub. 2.

Separation of Aluminium from Chromium.

If the chromium is present as chromic salt, it is oxidized by means of chlorine or bromine in a solution made strongly alkaline with potassium hydroxide. The solution is then acidified with nitric acid, and the aluminium precipitated by ammonia as hydroxide, being weighed as the oxide. In the absence of sulphuric acid the chromium may be determined in the filtrate as barium chromate (cf. p. 104). If sulphuric acid is present, the chromate is reduced to chromic salt again by the action of concentrated hydrochloric acid and alcohol, precipitated with ammonia, and weighed as the oxide.

If, however, the chromium is already present as chromate, the aluminium is at once precipitated with ammonia as hydroxide.

Separation of Iron from Titanium.

It is frequently necessary to determine both iron and titanium in a precipitate produced by ammonia consisting of a mixture of these two oxides alone, but it is more often necessary to determine

titanium in the presence of iron, aluminium, and phosphoric acid, all of which are precipitated by ammonia in the analysis of rocks.

For the separation of titanium from iron in the absence of alumina, the following methods are suitable:

1. The precipitate produced by ammonia is ignited and then fused with 15-20 times as much of previously dehydrated potassium pyrosulphate over a small flame until completely attacked. After cooling, the melt is dissolved in *cold* water containing sulphuric acid, and the solution is hastened by keeping the liquid in motion by means of a current of air passed through it.

The solution thus obtained is diluted to a definite volume, and after being thoroughly mixed is divided into two portions, one being used for the determination of titanium and the other for the determination of iron. For the iron determination, the acid solution is saturated with hydrogen sulphide in the cold, heated to boiling, and the precipitate of platinum sulphide, sulphur, and a little titanium is filtered off into a flask filled with carbon dioxide, and washed thoroughly with hot water. The filtrate is heated to boiling and carbon dioxide is passed through the solution until the excess of hydrogen sulphide is completely removed, when it is cooled in an atmosphere of carbon dioxide and then titrated with permanganate. For the titanium determination, the other part of the solution is treated with sodium carbonate solution until a slight precipitate is formed; this is dissolved in as little sulphuric acid as possible, saturated with hydrogen sulphide in the cold, and 5 gms. of sodium acetate which has been neutralized with acetic acid* are added. Carbon dioxide is conducted through the solution, it is heated to boiling, filtered hot, washed with water containing hydrogen sulphide, ignited wet in a platinum crucible, and weighed as TiO_2 .

Remark.—If considerable iron is present, the titanic oxide thus obtained is likely to contain iron. It is brought into solution again by fusing with potassium pyrosulphate and the precipitation is repeated exactly as before. In this way a precipitate free from iron is obtained.

2. The Chancel-Stromayer method is also satisfactory. The solution from the pyrosulphate fusion, in this case after being

* Cf. footnote to page 130.

neutralized with sodium carbonate, is treated with an excess of sodium thiosulphate, diluted to about 400–500 c.c. and boiled for some time. In this way metatitanic acid and sulphur are precipitated, while iron remains in solution. During the filtration, however, the finely divided sulphur passes through the filter, so that the first method is preferable. In the presence of considerable iron the metatitanic acid obtained by this method is also contaminated with iron, so that the separation must be repeated.

Separation of Aluminium from Titanium.

It has been proposed to separate aluminium from titanium by taking the slightly acid solution from the pyrosulphate fusion (page 115) diluting to a large volume and boiling for some time on the assumption that metatitanic acid will precipitate, leaving aluminium sulphate in solution. This method, however, is useless, for alumina is precipitated with the metatitanic acid unless the solution contains enough acid to prevent this hydrolysis, in which case a considerable amount of titanic acid remains in solution.

The best separation is that of Gooch;* it consists of boiling a solution of the two elements containing considerable free acetic acid and alkali acetate; by this means all of the titanium and none of the aluminium is precipitated. If, however, the amount of aluminium present is large (as is usual in rock analysis), the precipitate will contain some aluminium, so that the separation must be repeated. In no case is there danger of the precipitation of the titanium being incomplete.

In practice it is almost always necessary to separate the titanium not from aluminium alone, but from iron and aluminium, so that the method of Gooch will be described for this more general case.

The solution obtained by dissolving the pyrosulphate melt in *cold* water is treated with three times as much tartaric acid as the weight of the oxides, is saturated with hydrogen sulphide gas, and then made slightly ammoniacal. By this means all of the iron is precipitated as ferrous sulphide, while the aluminium and titanium remain in solution. The sulphide of iron is filtered off, the filtrate is acidified with sulphuric acid, heated to boiling, and the precipitate of sulphur and platinum sulphide (the latter from the platinum crucible in which the fusion with pyrosulphate was

* *Chemical News*, 52, pp. 55 and 68.

made) is filtered off. The filtrate is boiled to expel the last traces of hydrogen sulphide and the tartaric acid is destroyed by adding $2\frac{1}{2}$ times as much potassium permanganate as the amount of tartaric acid present. Sulphurous acid is then added until the precipitated manganese dioxide is redissolved, after which a slight excess of ammonia is added and then 7–10 c.c. of glacial acetic acid for each 100 c.c. of solution. The solution is boiled for one minute, the precipitate is allowed to settle, and the filtrate is decanted through a filter,* transferred to the filter, washed with 7 per cent. acetic acid and finally with hot water. The dried precipitate is ignited over a Bunsen burner for from fifteen to twenty minutes and then weighed.

The precipitate contains manganese and aluminium, so that it is fused with three times as much sodium carbonate. The melt (colored green by the manganese) is leached with cold water, leaving sodium metatitanate † and some alumina undissolved. The precipitate is filtered off by means of a small filter, is ignited in a platinum crucible, and fused again with a *little* sodium carbonate. After cooling, the contents of the crucible are dissolved in 1.9 c.c. of sulphuric acid (1 vol. conc. H_2SO_4 :1 vol. H_2O) diluted to about 150–200 c.c. and treated with 5 gm. sodium acetate and one-tenth of its volume of glacial acetic acid. After boiling one minute and allowing to stand until settled, the precipitate is filtered off, washed with 7 per cent. acetic acid, then with water, dried, ignited, and weighed. This precipitate usually contains aluminium, so that it is again fused with sodium carbonate and the melt again treated with sulphuric acid, etc., exactly as described above. This time the precipitate is usually free from aluminium, but the process should be repeated until a constant weight is obtained.

This analysis does not require much time, for usually the amount of titanium present is so small that the precipitates filter and wash quickly.

For the determination of very small amounts of titanium, it is advisable to use the colorimetric method proposed by Weller (cf. p. 100). Under the analysis of silicates will be discussed a practical example of this determination.

* Schleicher & Schüll's filter-paper No. 589 is satisfactory for this purpose.

† The sodium metatitanate undergoes hydrolysis and forms a precipitate containing a much higher percentage of TiO_2 .

Determination of Titanium in Rutile and Iron Ores.*

This method is based on the volatilization of the silica by hydrofluoric acid in the presence of sulphuric acid, evaporation to dryness and fusion with sodium carbonate and a little potassium nitrate (which converts the iron and titanium to insoluble ferric oxide and sodium acid titanate) extraction with hot water to remove the soluble phosphates, sulphates and aluminates, solution of the ferric oxide and sodium titanate in hydrochloric acid, extraction of ferric chloride with ether, reduction of slight traces of iron with sulphurous acid, precipitation of the titanic acid by boiling in acetic acid solution, filtration and ignition to titanium oxide (or the titanium may be determined colorimetrically). The method is accurate and not long.

Procedure.—The sample is weighed into a platinum crucible, treated with a little water, 5 to 10 drops of sulphuric acid, and 1 c.c. of hydrofluoric acid, and the mixture heated carefully until finally no more sulphuric acid fumes are evolved. Five or 10 grams of sodium carbonate and a *little* potassium nitrate † are added and the mixture fused at least thirty minutes. The crucible and cover are cooled, placed in a beaker, covered with hot water, and heated until the melt is disintegrated. Ferric oxide and sodium titanate are left insoluble in hot water. The crucible is removed, washed, and any adhering particles of ferric oxide and hydrolyzed sodium titanate are dissolved in hot hydrochloric acid (sp. gr. 1.1). This solution is saved. The residue in the beaker is filtered and washed with hot water.‡ The filter is perforated and the residue carefully washed into a clean beaker with hydrochloric acid (sp. gr. 1.1). (No water is to be added from this stage of the analysis until after the treatment with ether.) The hydrochloric acid washings from the platinum crucible are transferred to the beaker and the whole heated on the hot plate

* O. L. Barneby and R. M. Isham. *J. Am. Chem. Soc.*, **32**, 957 (1910).

† The potassium nitrate is added to make sure that the crucible is not injured by any sulfide or reducible metal which may be present. Too much nitrate should not be added; it will injure the crucible and also cause the melt to effervesce badly.

‡ The residue should not be washed with too much hot water; the hydrolysis of the sodium titanate may go so far that the residue will not dissolve in hydrochloric acid.

until solution is complete and the total volume reduced to 15 or 20 c.c. The solution is then cooled, 2 c.c. of concentrated hydrochloric acid are added and the solution is transferred to a separatory funnel, the beaker being rinsed with hydrochloric acid (sp. gr. 1.1). An equal volume of ether, which has been saturated with concentrated hydrochloric acid solution, is added to the solution in the funnel, a rubber stopper is inserted in the top, the funnel is inverted, the stop-cock opened, and the whole thoroughly shaken. The stop-cock is then closed, the funnel placed in an upright position and allowed to stand ten minutes, when the aqueous layer is drawn off into a second separatory funnel. The ether is rinsed twice by shaking well with 5 to 10 c.c. portions of hydrochloric acid (sp. gr. 1.1) and the washings are added to the aqueous solution. The treatment with ether is repeated two or three times until the last portion of ether fails to show any greenish tinge due to the presence of dissolved ferric chloride.

The aqueous solution containing all the titanium in the presence of little, if any, iron and aluminium, is heated to expel the dissolved ether, 20 c.c. of sulphuric acid (1 : 1) are added, and the solution evaporated until fumes of sulphuric anhydride are evolved. The cooled solution is diluted to about 100 c.c. and nearly neutralized with ammonia. One or two grams of ammonium bisulphite are added and the solution heated on the hot plate for half an hour. Ten to 15 grams of ammonium acetate are now added with 5 to 10 c.c. of glacial acetic acid, and the solution boiled for fifteen minutes. The precipitated titanic acid is filtered off, washed with 7 per cent. acetic acid, ignited and weighed as TiO_2 .

Separation of Uranium from Iron and Aluminium.

The slightly acid solution, containing considerable quantities of ammonium salts, is treated with an excess of ammonium carbonate and then with ammonium sulphide, allowed to stand for some time in a closed flask, finally filtered and washed with water containing ammonium sulphide.

The precipitate contains the iron as sulphide and the aluminium as hydroxide; in the filtrate is found all of the uranium as $(NH_4)_4UO_2(CO_3)_3$. The precipitate is dissolved in hydrochloric

acid, its solution freed from hydrogen sulphide by boiling, the ferrous salt oxidized to ferric salt by the addition of potassium chlorate, and the iron and aluminium determined by one of the methods described on pages 107–109.

The filtrate containing the uranium is evaporated almost to dryness, acidified with hydrochloric acid, boiled, and the uranium precipitated, by the addition of ammonia, as ammonium uranate. The precipitate is filtered off, washed with 2 per cent. ammonium nitrate solution to which a little ammonia has been added, dried, ignited, and weighed as U_3O_8 .

The result obtained may be verified by heating the residue repeatedly in a current of hydrogen in a Rose crucible (see Copper Determination) until a constant weight is obtained; weighing as UO_2 . The purity of the precipitate may also be tested volumetrically (see Volumetric Analysis).

B. DIVISION OF THE MONOXIDES.

MANGANESE, NICKEL, COBALT, ZINC.

MANGANESE, Mn. At. Wt. 54.93.

Forms: $MnSO_4$, MnS , Mn_3O_4 , $Mn_2P_2O_7$.

1. Determination as Manganous Sulphate, $MnSO_4$.

This method, first proposed by Volhard,* has recently been tested by Gooch and Austin,† and has been found strictly accurate. Experiments performed by Schudel in the author's laboratory completely confirm Gooch's results.

Procedure.—The oxide obtained by the ignition of the carbonate, sulphide, or of manganous manganite, is dissolved in as slight an excess of sulphuric acid‡ as possible in a porcelain crucible, evaporated as far as possible on the water-bath, after which the excess of acid is removed by heating in an air-bath. A porcelain crucible provided with an asbestos ring (see Fig. 11, p. 27) serves for the air-bath. The walls of the smaller crucible should be separated from those of the larger one by about 1 cm.

* Ann. d. Chem. u. Pharm., **198**, p. 328.

† Z. anorg. Chem., **17**, 264 (1898); cf. Blum, J. Am. Chem. Soc., **34**, 1382 (1912).

‡ The manganous manganite (Mn_3O_4) requires the presence of reducing agent (best SO_2 or pure hydrogen peroxide).

After the sulphuric acid has been removed, the two crucibles are covered and heated to redness over a good Bunsen burner, allowed to cool in a desiccator and weighed. From the weight of the manganous sulphate, the amount of manganese present may be calculated as follows:

$$\text{MnSO}_4:\text{Mn}=p:x$$
$$x=\frac{\text{Mn}}{\text{MnSO}_4}\cdot p.$$

(a) Separation of Manganese as Carbonate.

This method for the separation of the manganese permits only a limited application, because no other metal that is precipitated by alkali carbonates can be simultaneously present. The method, therefore, is only suitable for the determination of manganese in solutions of pure manganese salts containing nothing else except alkali and ammonium salts.

According to H. Tamm,* the precipitation is best accomplished by means of ammonium carbonate. For this purpose the neutral solution (which may contain other ammonium salts) is treated with a slight excess of ammonium carbonate, warmed gently, and the beaker containing the solution is allowed to remain in a luke-warm water-bath until the precipitate has settled and the upper liquid has become clear.

The precipitate is filtered off, washed with hot water, dried, ignited, and weighed either as sulphate according to 1 or as Mn_2O_3 according to 2.

Remark.—If either sodium or potassium carbonate is used to precipitate the manganese, the precipitate will always contain alkali carbonate that cannot be removed by washing. After the precipitate has been ignited, however, the alkali carbonate can be easily extracted by water. Furthermore, the precipitation is not quite quantitative; the filtrate always contains small amounts of manganese. In order to remove this, it is necessary to evaporate the aqueous solution to dryness, whereby the manganous carbonate is completely decomposed hydrolytically into carbonic acid and manganous hydroxide, and the latter in contact with the air

* Chem. News, 26 (1872), p. 37, and Z. anal. Chem. 11, p. 425 (1872).

changes to brown manganic oxide, Mn_2O_3 . The residue obtained after the evaporation is treated with water, the small amount of brown manganese compound filtered off, ignited, and added to the main part of the precipitate.

(b) **Separation of Manganese as Sulphide.**

This method is employed when it is necessary to separate manganese from calcium, strontium, barium, and magnesium.

We will distinguish between two different cases:

(α) The solution contains, besides manganese, large amounts of the alkaline earths or magnesium.

(β) The solution contains only small amounts of the alkaline earths or magnesium.

(α) In case large amounts of the alkaline earths or magnesium are present, the manganese sulphide must be precipitated in the cold in the presence of considerable ammonium salts.

The solution is placed in an Erlenmeyer flask of Jena glass and about 5 gm. of ammonium chloride or ammonium nitrate are added. In case the solution reacts acid, ammonia is added until it is slightly alkaline, and a slight excess of freshly-prepared, colorless ammonium sulphide solution is added. The flask is now nearly filled with cold distilled water that has been boiled, corked, and allowed to stand twenty-four hours, or, better, still longer. After this time the flesh-colored precipitate will have settled. The clear upper liquid is carefully decanted through a filter,* taking pains not to disturb the precipitate and to keep the filter filled with liquid all the time. If the precipitate is at all bulky, it is washed three times by decantation with a 5 per cent. solution of ammonium nitrate to which has been added 1 c.c. of ammonium sulphide. The precipitate is then transferred to the filter and washed with dilute ammonium sulphide water until 20 drops of the filtrate evaporated to dryness on a crucible-cover leave no residue. Now for the first time the filter is allowed to drain completely and is dried. As much of the precipitate as possible is transferred to a small thin-walled porcelain crucible, the filter-paper is burned in a platinum spiral, and the ash added to the main portion of the precipitate in the crucible. The uncovered crucible is heated over a small flame until the greater

* Schleicher & Schüll's filter-paper No. 590 can be used to advantage.

part of the sulphur has been burned off, when the flame is increased and the crucible is finally heated over the flame of a Teclu burner, cooled, and weighed as Mn_3O_4 (cf. p. 125, sub. 3). The heating is repeated until a constant weight is obtained. Manganous sulphide is readily changed to Mn_3O_4 if the amount of sulphide is comparatively small. In case more than 0.2 gm. is present there is danger of getting a too high result on account of some manganous sulphate not being decomposed. In this case it is advisable to dissolve the washed precipitate of manganous sulphide in dilute hydrochloric acid, to evaporate the solution to dryness in order to remove all hydrogen sulphide, to dissolve the residue in a little water and to precipitate the manganese as carbonate according to 1; or the manganous sulphide can be weighed as such. (See p. 125.)

(β) In case only small amounts of alkaline earths are present, the following procedure can be used: The neutral solution is heated to boiling, an excess of ammonia and some ammonium sulphide is added and the boiling is continued until the manganous sulphide has become a dirty green. The precipitate is allowed to settle for some minutes and is then filtered and washed with water containing a little ammonium sulphide. From this point the procedure is the same as described under (α).

(c) Separation of Manganese as Manganese Dioxide.

If a dilute solution of a manganous salt is treated with bromine water and boiled, the reaction

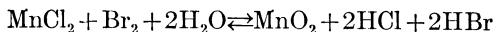

does not take place unless the halogen acids are neutralized as fast as they are formed. This neutralization can be accomplished by means of the salt of a weak acid, such as sodium acetate, even when the solution contains free acetic acid, which is scarcely ionized at all in the presence of its alkali salt. Thus in a solution such as is obtained after the removal of iron and aluminium by a basic acetate separation (cf. p. 152); the manganese can be precipitated quantitatively by boiling with an excess of bromine water. The oxide does not correspond exactly to MnO_2 , although most of the manganese is in the quadrivalent

condition.* When the precipitate has collected together in large flocks, the boiling is discontinued and the precipitate allowed to settle; it is filtered and washed with hot water. Some chemists ignite this precipitate and weigh as Mn_3O_4 but it is more accurate to dissolve the precipitate in a mixture of HCl and H_2SO_3 and to precipitate the manganese finally as manganese ammonium phosphate. (See 4, p. 126.)

Chlorine, hydrogen peroxide, hypochlorites, etc., may be used instead of bromine, but these reagents have no especial advantages.

When the solution of the manganous salt contains ammonium salts, the precipitation of the manganese does not take place by the above procedure, because the sodium acetate serves rather to neutralize the acid set free by the following reaction:

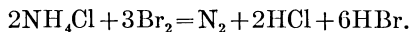

Upon the addition of ammonia, however, the precipitation of the manganese can be effected. In this case, it seems fair to assume that the reaction goes through the following stages:

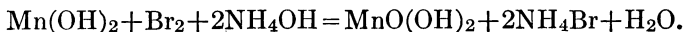
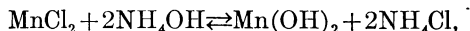

The precipitation with bromine and ammonia is not so satisfactory as with bromine alone in the presence of acetic acid and sodium acetate and in the absence of ammonia or ammonium salt, because when ammonia is present much of the bromine is used up in oxidizing the ammonia or ammonium salt. In that case there is considerable solution of nitrogen, and, moreover, when an excess of bromine is added the solution may become acid enough to dissolve the precipitated manganese:

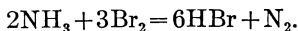

* The MnO_2 acts as the anhydride of metamanganous acid, H_2MnO_3 , and some manganous manganite, $MnMnO_3$ or Mn_2O_3 , is contained in the precipitate.

It is necessary, therefore, when ammonium salts are present to make sure that the solution is ammoniacal at the end of the operation.

This method of precipitating manganese from solutions possesses disadvantages which make it useless in many cases. If, besides manganese, the solution contains calcium, zinc, etc., manganites of these metals are precipitated with the manganese. In this case the precipitate must be dissolved in hydrochloric acid and the precipitation repeated several times, but even then it is not possible to obtain a precipitate altogether free from these metals. If the other metals are present only in small amounts, the results obtained by this method are sufficiently accurate. The precipitation of manganese as sulphide in the presence of other metals is always satisfactory and should be used in almost all cases.

2. Determination of Manganese as Sulphide.

If the manganese has been precipitated, as described on p. 122 as sulphide, the precipitate is separated from the filter as completely as possible, placed in a Rose crucible (of unglazed porcelain), the filter is burned in a platinum spiral, and the ash added to the main portion of the precipitate. Some pure sulphur which has been crystallized from CS_2 is added, after which the crucible and its contents are heated in a current of hydrogen by means of a Bunsen burner exactly as described under the Determination of Copper as Sulphide. After the excess of sulphur has distilled off and been burned, the crucible is cooled in a stream of hydrogen and the precipitate is weighed as MnS .

3. Determination of Manganese as Mn_3O_4 .

Inasmuch as all the oxides of manganese, as well as those compounds which are converted into oxide on ignition (manganous salts of volatile organic and inorganic acids, with the exception of the halogen salts), are converted into Mn_3O_4 * on being ignited in the air, at temperatures between 940° and 1100° , it

* Cf. R. J. Meyer and K. Retgers, *Z. anorg. Chem.*, **57**, 104 (1908), at 530° the oxides of manganese are slowly but quantitatively changed into Mn_2O_3 .

follows that this method for the determination of manganese is quite generally applicable. It is nearly as accurate as the methods described under 1 and 2, if the ignition of the precipitate takes place in an electric furnace at about 1000° , but very good results are obtained if, as recommended by Gooch,* the porcelain crucible (containing the carbonate, manganous manganite, or sulphide) is entirely surrounded by the oxidation flame of a Teclu burner, whereby a moderately high heat is obtained without too much free access of air.†

After the ignition, the crucible and its contents are cooled in a desiccator and then weighed. From the weight p of the oxide, the amount of manganese can be calculated according to the equation

$$\text{Mn}_3\text{O}_4 : 3\text{Mn} = p : x$$

$$x = \frac{3\text{Mn}}{\text{Mn}_3\text{O}_4} \cdot p.$$

4. Determination of Manganese as Manganese Pyrophosphate, $\text{Mn}_2\text{P}_2\text{O}_7$.

This excellent method was recommended by W. Gibbs‡ and subsequently studied by Gooch and Austin.§

The slightly acid solution, containing an amount of manganese corresponding to not over 0.5 gm. $\text{Mn}_2\text{P}_2\text{O}_7$ in 250 c.c., and no other metals except alkalies, is treated with 20 gm. ammonium chloride, 5 to 10 c.c. of a cold saturated solution of sodium phosphate, and ammonia, drop by drop, until a *slight* excess is present. The solution is heated to boiling and kept at this temperature for

* Zeit. f. anorg. Chem., XVII (1898), p. 268.

† To illustrate the accuracy of the three methods just described for the determination of manganese, the following results obtained by H. Weitnauer are given. He obtained after making six determinations by each method the following mean values: 50 c.c. of a pure manganese sulphate solution treated with ammonium carbonate and changing the precipitate to sulphate gave 0.1025 gm. Mn; by precipitating as sulphide and weighing as such, 0.1027 gm. Mn; and by changing the sulphate to Mn_3O_4 , 0.1029 gm. Mn.

‡ Am. J. Science, 46, 216; Z. anal. Chem., 7, 101 (1868).

§ Z. anorg. Chem., 18, 339 (1898).

three or four minutes, or until the precipitate assumes a silky, crystalline appearance. After cooling, the precipitate is filtered through a Gooch or Munroe crucible, washed with cold ammonium nitrate solution, dried, and ignited within a larger crucible or in an electric furnace.

The results are excellent.

Manganese can be determined very accurately by volumetric methods (see Volumetric Analysis).

5. Colorimetric Determination of Manganese.

Small amounts of manganese may be accurately and quickly determined by the *colorimetric method*. This is chiefly used for the estimation of the manganese present in iron and steel. If more than 1.5 per cent. of manganese is present, the results are unreliable. The method depends upon the oxidation of the manganese to permanganic acid, bringing the solution to a definite volume and comparing its color with another solution containing a known amount of manganese. If the solutions are colored exactly the same shade, then the amounts of manganese which they contain are the same.

Procedure.—A standard solution of potassium permanganate is first prepared by dissolving 0.072 gm. of the crystallized salt in 500 c.c. of water; 1 c.c. of this solution contains 0.05 mgm. of manganese.

Exactly 0.2 gm. of the iron or steel is dissolved in 15–20 c.c. of nitric acid (sp. gr. 1.2) in a 100-c.c. measuring-flask. The acid is heated to boiling to effect complete solution, after which the solution is allowed to cool and diluted up to the mark with water. After thoroughly mixing, 10 c.c. of the liquid are brought by means of a pipette into a small beaker, 2 c.c. of nitric acid (sp. gr. 1.2) are added, and the liquid is heated until it begins to boil, when the flame is removed, 0.5 gm. of lead peroxide is added, the mixture is shaken and then heated for two minutes to boiling. After standing some time, the warm, violet-colored solution is filtered through a small asbestos filter* into a glass-stoppered test-tube

* The asbestos must have been previously ignited, treated with KMnO_4 solution, and finally washed with water.

about 20 cm. high, and graduated in cubic centimeters. The filter is washed with as little water as possible, the tube is stoppered and shaken until the solution is thoroughly mixed. Into a second tube of the same size, and also graduated in cubic centimeters, is placed 1-5 c.c. of the standard manganese solution, and this is carefully diluted with water until the two liquids have exactly the same shade when viewed *horizontally*. The height of the liquid in each tube is then carefully read.

Assuming that 1 c.c. of the standard solution were placed in the cylinder and diluted to T c.c. in order to obtain the same shade produced by t c.c. of the other solution, then as the concentrations of the two liquids are directly proportional to their heights,

$$T:t=0.05 \text{ mgm.}:x$$

$$x = \frac{t \cdot 0.05 \text{ mgm.}}{T}$$

This amount of manganese is contained in 0.02 gm. of the iron, so that the percentage of manganese present is

$$0.02 : \frac{t \cdot 0.00005}{T} = 100 : x$$

$$x = \frac{t}{4T} = \text{per cent. Mn.}$$

Rather more accurate results are obtained if, instead of using a standard solution obtained from potassium permanganate, a sample of steel is used containing a known amount of manganese and treated in exactly the same way as the sample to be analyzed, a fresh standard being prepared for each analysis.

An even better colorimetric method has been devised by M. Marshall* and H. E. Walters.†

Although manganese is precipitated as manganous acid, from solutions slightly acid with nitric or sulphuric acid, by the addition of alkali persulphates, the oxidation goes farther and

* Chem. News, 83, 76 (1904).

† *Ibid.*, 84, 239 (1904).

permanganic acid is formed within a short time if a catalytic agent is present, such as silver nitrate.

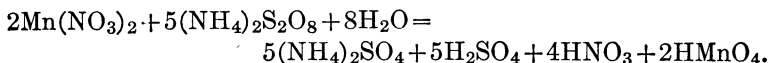

Procedure.—0.2 gm. of steel is placed in a 100-c.c. flask and dissolved in 20 c.c. of cold nitric acid (sp. gr. 1.2). Thereupon 10 c.c. of silver nitrate solution (1.38 gm. AgNO_3 in a liter of water), are added, the solution made up to exactly 100 c.c. and mixed. Of this solution 10 c.c. are placed in glass-stoppered, graduated test-tube. After adding 2.5 c.c. of ammonium persulphate solution (200 gm. in a liter of water) the test-tube is placed in water at 80° to 90° and allowed to remain there until the bubbles of gas arising become more numerous and remain at the top for a few seconds. The solution is then cooled by placing the tube in cold water, and the color is compared with a standard solution containing a known amount of permanganic acid.*

NICKEL, Ni. At. Wt. 58.68.

Forms: Nickel Dimethyl Glyoxime, $\text{NiC}_8\text{H}_{14}\text{N}_4\text{O}_4$; Nickel, Ni; and Nickel Oxide, NiO.

i. Determination as Nickel Glyoxime, $\text{Ni}(\text{C}_4\text{H}_7\text{N}_2\text{O}_2)_2$.

Dimethyl glyoxime, $\text{CH}_3\cdot\text{CNOH}\cdot\text{CNOH}\cdot\text{CH}_3$, was recommended by L. Tschugaeff † as a reagent for nickel and used by K. Kraut ‡ for detecting the presence of traces of nickel in ashes. O. Brunck § and others have also studied the reaction and found it to furnish a most rapid and accurate method for the quantitative estimation of nickel either by itself or in the presence of cobalt, zinc and manganese. If the solution contains tartaric acid enough to prevent the precipitation of iron by ammonia, the

* Or better a solution of a steel of known manganese content.

† *Z. anorg. Chem.*, **46**, 144 (1905); *Ber.*, **38**, 2520 (1905).

‡ *Z. angew. Chem.*, **19**, 1793 (1906); *ibid.*, **20**, 1844 (1907).

§ *Ibid.*, **20**, 834 (1907).

nickel in a sample of nickel steel can be determined accurately within two hours and without the removal of any other metal.

When a dilute, neutral solution of a nickel salt is treated with an alcoholic solution of dimethyl glyoxime, a red, crystalline precipitate of nickel dimethyl glyoxime is formed.

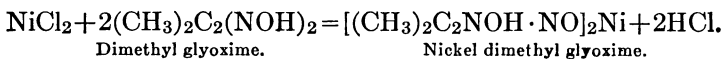

The salt is soluble in mineral acids so that precipitation is incomplete because of the acid set free in the reaction. It becomes quantitative, however, if the mineral acid is neutralized by ammonia or if sodium acetate is added, whereby the mineral acid is replaced by acetic acid in which the precipitate is practically insoluble. Large quantities of ammonium salts or of alkali acetate do no harm, but an excess of ammonia tends to prevent the formation of the precipitate. The precipitate is distinctly soluble in absolute alcohol, but only traces dissolve in 50 per cent. alcohol, and in more dilute alcohol it is even less soluble. When thrown down in the cold or in the presence of much free ammonia the precipitate is very voluminous and hard to filter.

Procedure.—The neutral or slightly acid* solution is diluted so that not more than 0.1 gm. of cobalt is present in 100 c.c., heated nearly to boiling and treated with somewhat more than the theoretical amount of an alcoholic 1 per cent. solution of dimethyl glyoxime.† Ammonia is then cautiously added until the solution smells slightly. While still hot, the precipitate is filtered into a Gooch or Munroe crucible, washed with hot water and dried at 110° to 120° for 45 minutes. It contains 20.31 per cent. Ni.

The nickel salt of dimethyl glyoxime is red and crystalline. It contains no water of crystallization and sublimes at 250° without decomposition.

* If strongly acid, the solution is nearly neutralized with caustic potash, then the reagent is added, etc.

† The volume of the alcoholic solution should in no case be more than half that of the nickel solution, as the precipitate is soluble in alcohol.

2. Determination of Nickel as Metal by Electrolysis.

From strongly *acid* solutions nickel is not deposited upon stationary electrodes by a current of 1–3 amperes. From slightly acid solutions the deposition is not quantitative.

From *ammoniacal* solutions nickel is readily deposited, and on account of its simplicity and accuracy this method is to be strongly recommended for the determination of nickel.

(a) Method of Gibbs.*

Nickel sulphate or chloride (but not the nitrate) is dissolved in an ammoniacal solution of ammonium sulphate and electrolyzed.

The nickel is deposited upon a weighed cathode and, at the end of the electrolysis, the gain in weight represents the quantity of nickel.

Requirements and Procedure.—For this, as well as for all other electrolytic determinations, the apparatus shown in Fig. 31 may be used.

B represents a storage-battery, which is provided with the binding posts *MM*. The current is led first through the variable resistance *W*, then through the known resistance *W'* (a resistance of 1 ohm is most convenient to use †), and from here to the decomposition cell finally back to the battery.

If at any time it is desired to measure the voltage between the electrodes of the cell, the voltmeter *V* is connected with the binding posts of the decomposition cell, by throwing the switch *Q*, ‡ Fig. 32, so that *c* is connected with *b* and *c'* with *b'*. The

* *Z. anal. Chem.*, 3, 334 (1864). Cf. Fresenius and Bergmann, *Z. anal. Chem.*, 19, 320 (1880).

† The resistance $w' = 1 \Omega$ can be made from nickelin wire. The resistance of the wire is measured with the aid of the Wheatstone bridge and a length cut off corresponding to one ohm. This wire is wound round a wooden block and the ends fastened to binding posts.

‡ If a commutating switch is not available, one can be prepared by taking the cover of a pasteboard box, about 2 cm. deep, filling it with melted paraffin, and then, after cooling, making little cavities at *aa'bb'cc'* by pressing a test-tube, which is filled with hot water, against the cold wax. These cavities are filled with mercury and the switch finished with copper wire. Cf. Fig. 36, p. 178.

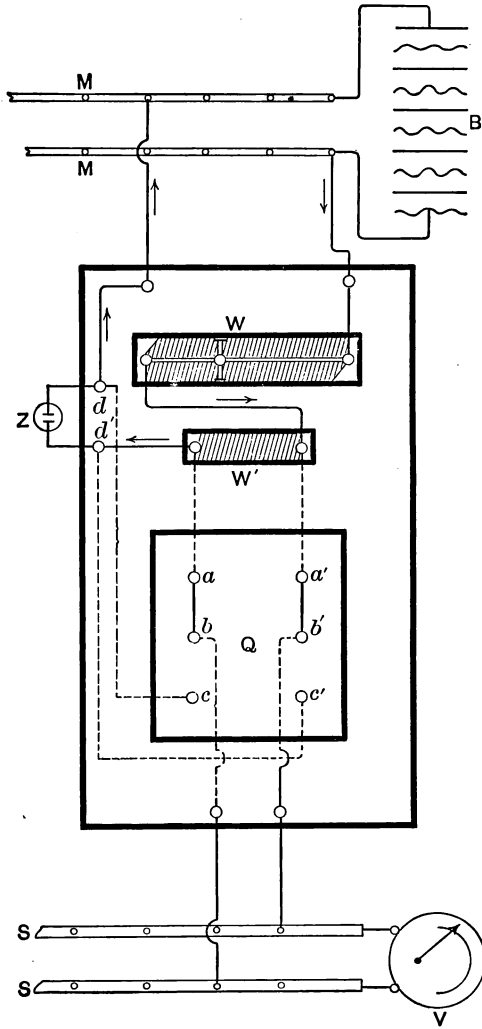

FIG. 31.

strength of the current, on the other hand, is obtained by placing the switch in the opposite position with a united to b and a' to b' , as shown in Figs. 31, 32.

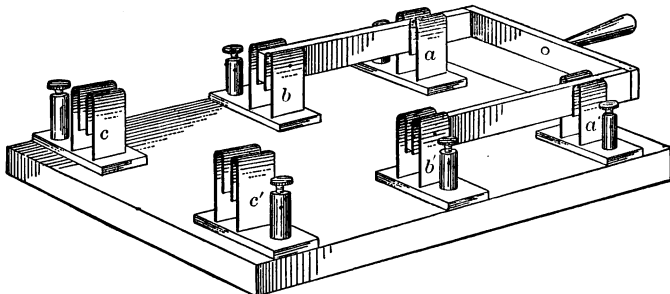

FIG. 32.

Since, according to Ohm's law, the

$$\text{Strength of current} = \frac{\text{Electromotive force}}{\text{Resistance}},$$

then if the strength of the current is expressed in amperes, the electromotive force in volts, and the resistance in ohms, we have

$$A = \frac{E}{R}.$$

In case $W' = 1$ ohm, then

$$A = E,$$

and the voltmeter will show directly the strength of the current (amperes).*

It is arranged so that the current may be taken from different points along MM , and it is thus possible to carry out a number of electrolytic determinations at the same time, and the voltmeter V serves as measuring instrument for all the analyses that are in progress. By means of the SS it is possible to connect easily the voltmeter with the different cells. While a measure-

* With weaker currents, the known resistance can be made $W' = 10\Omega$ so that the voltmeter will show ten times the actual current.

ment is being made at any cell, all other switches must be cut out of circuit.

The decomposition cell consists of a glass beaker in which is placed as cathode a wire gauze electrode (first recommended by Cl. Winkler) and as anode a platinum spiral. The electrodes

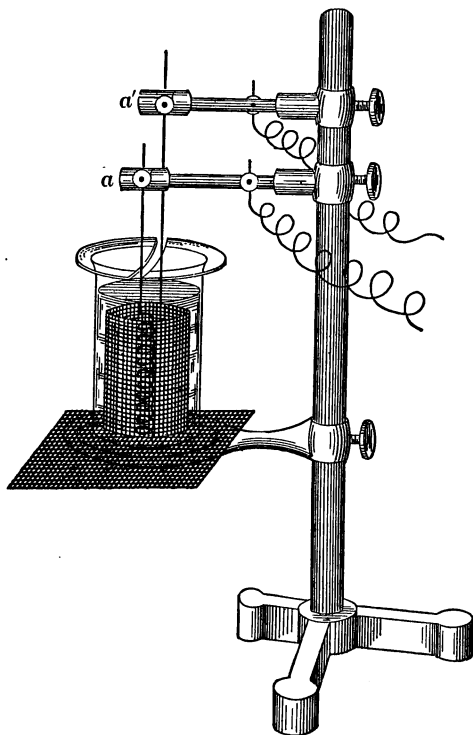

FIG. 33.

must always reach to the bottom of the beaker and the top of the gauze electrode should be nearly covered by solution. In some cases it is desirable to use a platinum dish as cathode, as recommended by Classen. (See Fig. 36, p. 178.)

The electrodes are usually connected with two electrode stands on which metal arms are attached to an upright glass rod (Fig. 33). To prevent serious loss of electrolyte by spattering,

the beaker is covered with two halves of a watch-glass. This is not entirely satisfactory, as when much gas is evolved a little of the liquid is still carried off mechanically. This method of fastening the electrodes, moreover, has the disadvantage that when the electrolysis is carried out in a hot solution, acid or ammoniacal vapors, as the case may be, condense on the brass

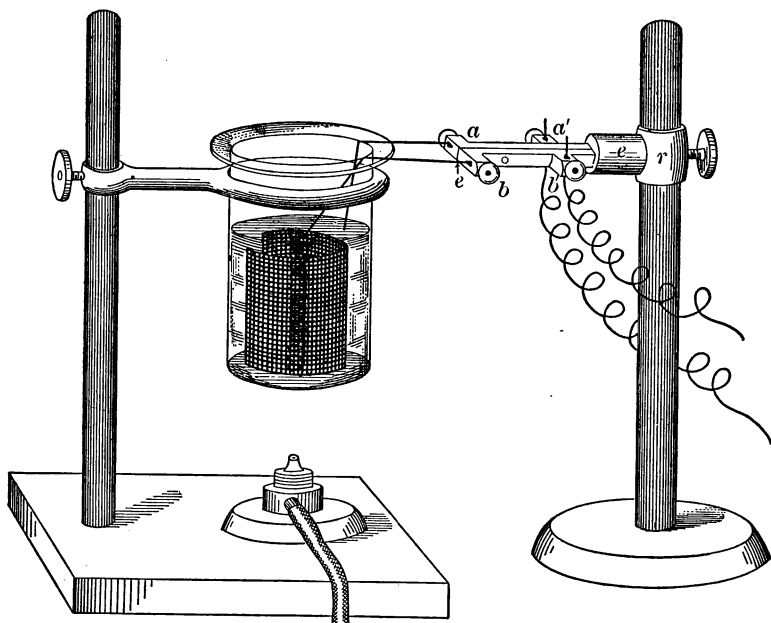

FIG. 34.

arms of the electrode support and in some cases the liquids thus condensed dissolve some brass and the resulting solution may drop into the beaker, and spoil the analysis. To prevent this misfortune, the author bends the ends of the electrodes to a right angle and connects them with an electrode stand designed as shown in Fig. 34.

This electrode holder consists of two brass rods insulated from one another by means of an intervening layer of mica, and the rods are fastened to the ring *r* through a piece of ebonite, *e*.

The openings to hold the wires are cut wedge-shaped, so that any shape of wire can be inserted.

Since the ends of the electrodes leave the beaker in a horizontal direction, the beaker can be covered tightly by means of a whole watch-glass, and not only are losses by spattering avoided, but there is absolutely no danger of contamination from the outside.

The Electrolysis of Nickel.

For every 0.25–0.30 gm. nickel, present as sulphate or chloride, but not as nitrate, * 5–10 gm. of ammonium sulphate and 30–40 c.c. of concentrated ammonia are added, and the solution diluted with distilled water to a volume of 150 c.c. This solution is electrolyzed at the room temperature with a current of 0.5–1.5 amperes and an electrode potential of 2.8–3.3 volts. The electrolysis is finished after three hours, as can be shown fairly satisfactorily by adding a little water and allowing the current to pass through the solution for fifteen or twenty minutes longer. If at the end of this time no nickel has deposited upon the electrode surface which was wet for the first time by the last dilution, the determination is finished. If the solution is kept at a temperature of from 50°–60° C. only about one hour is necessary for the deposition. The deposited metal adheres firmly to the electrode, is bright, and possesses almost the color of platinum.

As soon as the electrolysis is finished, the watch-glass is removed, the electrode holder is raised so that only the bottoms of the electrodes remain in the liquid, and the upper parts of the electrodes are washed thoroughly with water from a wash-bottle. The electrodes are then raised entirely out of the solution and the bottoms washed immediately with water. The current is then turned off and the cathode rinsed with absolute alcohol, after which it is dried by holding it high above a gas flame. After cooling in a desiccator, it is weighed.

To clean the cathode, place it in a small beaker, add enough nitric acid (1:1) to wet all the nickel, and heat for at least fifteen minutes. This treatment is absolutely necessary to remove the last traces of nickel. If this is not done, the electrode on being

* Page 131.

ignited becomes discolored, and it is then very difficult to clean the electrode by repeated treatment with acid followed by ignition. The discolored electrode, however, can be used for another electrolytic determination. To make sure that all the nickel has been deposited from the electrolyzed solution, the ammonia is almost wholly neutralized with hydrochloric acid and a few cubic centimeters are added of 1 per cent. solution of dimethyl glyoxime in alcohol. When less than a tenth of a milligram of nickel is present, it will take several minutes for a yellow coloration to appear, and soon afterward the red crystals of nickel salt will be precipitated.

The nickel not deposited by an electrolysis may be estimated accurately by shaking the solution thoroughly and comparing the color produced by the addition of dimethyl glyoxime with that produced with a dilute nickel solution containing a known quantity of nickel. Naturally such a colorimetric test can be used only with very small quantities of nickel.

Remark.—The electrolysis of nickel from an ammoniacal solution should not be continued for too long a time, because the cathode slowly gains in weight even after all the nickel has been deposited from the solution. The anode is attacked, causing platinum to go into solution, which is deposited upon the cathode, partially, at least.

The presence of too little ammonia often results in the formation of black $\text{Ni}(\text{OH})_2$ at the anode; the analysis then comes out too low.

Classen's method for depositing nickel from a solution of ammonium oxalate apparently gives too high results* and cannot be recommended.

3. Determination as Nickelous Oxide.

The nickel solution is heated in a porcelain dish with bromine water and an excess of pure potassium hydroxide, whereby the nickel is precipitated as brownish-black nickelic hydroxide, $\text{Ni}(\text{OH})_2$. The precipitate is filtered off, washed by decantation

* A. Windelschmidt, Dissertation, Münster, 1907. W. D. Treadwell, Dissertation, Zürich, 1909.

with hot water, dried, and, after burning the filter, ignited and weighed as NiO. The grayish-green oxide thus obtained always contains small quantities of silicic acid and alkali,* whereby the results are too high. By treating the ignited mass with hot water, the greater part of the alkali can be removed. Drying and again igniting gives the weight of NiO+SiO₂. The oxide is treated in a porcelain crucible with hydrochloric acid, evaporated completely to dryness, the dry residue moistened with concentrated hydrochloric acid and then with hot water, filtered through a small filter, washed with hot water, and the filter together with the residue ignited wet in a platinum crucible. The weight of this silica, SiO₂, subtracted from the former weight of NiO+SiO₂, gives good results.

Remark.—It is possible to precipitate nickel quantitatively as Ni(OH)₂ by means of caustic potash alone and the precipitate is changed to NiO by ignition. This method is open to the same objections as the above and, furthermore, Ni(OH)₂ is not so easily filtered and washed as Ni(OH)₃.

These two methods are more tedious to carry out and the results are not as accurate as in the case of the first two methods described and will probably not be used much in the future.

Besides the methods described, it has been proposed to precipitate nickel as the sulphide, and weigh it as the oxide by ignition in air.† The method is good but hardly comparable with the dimethyl glyoxime method, the electrolytic method, or the volumetric titration with potassium cyanide.

COBALT, Co. At. Wt. 58.97.

Forms: Co, CoSO₄.

1. Determination as Metal.

(a) By Electrolysis.

The most accurate method for the estimation of cobalt is by electrolysis and the details of the process are precisely the same as have been given under nickel, i. e., from a strongly ammoniacal

* Cf. A. Windelschmidt, *loc. cit.* and W. D. Treadwell, *loc. cit.*

† H. Cormimboef, *Ann. chim. appl.*, II, 6 (1906). Cf. A. Windelschmidt, *loc. cit.*

solution containing ammonium salts and the sulphate or chloride (preferably the former), of cobalt. It is customary to use a little more ammonia than in the determination of nickel, because cobalt has a greater tendency to deposit as black $\text{Co}(\text{OH})_3$ at the anode. The duration of the electrolysis is the same as with nickel, rather than somewhat longer. At the end of the determination, after the electrodes have been removed, the entire solution is tested for cobalt by adding ammonium sulphide or potassium sulphocarbonate.

(b) **By Reduction of the Oxide in a Stream of Hydrogen.**

The cobalt solution is heated to boiling in a porcelain evaporating-dish, and the cobalt is precipitated as black cobaltic hydroxide by the addition of caustic potash and bromine water. The precipitate is filtered off,* dried, and ignited. After cooling it is treated with water in order to remove the small amount of alkali which is always present, and then the residue is ignited in a stream of hydrogen and weighed as metal. After weighing, the metal is dissolved in hydrochloric acid, evaporated to dryness, the dry mass moistened with hydrochloric acid, then treated with water, and the small residue of silicic acid filtered off. This residue is ignited and its weight subtracted from that obtained after the ignition in hydrogen. Cobalt may also be precipitated as cobaltous hydroxide by caustic potash alone, but the resulting precipitate is not so easy to filter and wash as the cobaltic hydroxide. The precipitation by means of sodium carbonate is not so satisfactory.

The oxides of cobalt when ignited in air yield a mixture of CoO and Co_3O_4 in varying proportions, so that they are not suited for the quantitative determination of cobalt.

Remark.—The results obtained by this method are usually a little higher than by electrolysis.

* Cobaltic hydroxide, unlike nickelic hydroxide, has the tendency of giving a turbid filtrate on washing. If, however, Schleicher & Schüll's filter-paper No. 589 (blue band) is used, none of the precipitate passes through.

2. Determination as Sulphate.

The method is the same as was described under Manganese (p. 104).

ZINC, Zn. At. Wt. 65.37.

Forms: ZnNH_4PO_4 , $\text{Zn}_2\text{P}_2\text{O}_7$, ZnO, ZnS, Zn.

1. Determination as Zinc Ammonium Phosphate or Zinc Pyrophosphate.

This excellent method, first recommended by H. Tamm,* has been studied and improved by G. Lösekann and T. Meyer,† M. Austin,‡ and especially H. D. Dakin.§

Procedure.—The cold acid|| solution of the zinc salt is treated with ammonia, in a platinum or porcelain dish, until it is left barely acid. Care is necessary at this point, as zinc ammonium phosphate is soluble both in acids and ammonia. It is then diluted with water to a volume of 150 c.c. and heated on the water-bath. To the hot solution, ten times as much ammonium phosphate is added as there is zinc present. (If the diammonium phosphate contains some monoammonium phosphate, the salt should be dissolved in cold water and dilute ammonia added until the solution just becomes pink with phenolphthalein.) The precipitate that first forms is amorphous, but it soon changes into fine crystals of zinc ammonium phosphate. The transformation takes place more rapidly in proportion to the quantity of ammonium salts present. After the heating has continued for about fifteen minutes, the dish is removed from the water-bath and after being allowed to settle for a short time the precipitate is filtered through a Gooch or Munroe crucible, washed with hot, 1 per cent. ammonium phosphate solution ¶ until free from chlorides

* Chem. News, 24, 148.

† Chem. Ztg., 1886, 729.

‡ Am. J. Sci., 1899; Z. anorg. Chem., 22, 212 (1900).

§ Z. anal. Chem., 39, 273 (1900).

|| If the solution is neutral, 2 or 3 gms. of ammonium chloride are added and then the analysis carried out.

¶ According to Voigt, Z. angew. Chem., 1909, 2282, the precipitate is washed immediately with hot water.

etc., then twice with cold water, then with 50 per cent. alcohol, dried at 110–120° for an hour and weighed as ZnNH_4PO_4 , which contains 36.64 per cent. Zn.

Or, the precipitate may be weighed as the pyrophosphate, $\text{Zn}_2\text{P}_2\text{O}_7$, in which case the dried zinc ammonium phosphate is heated very slowly in an electric oven to 900°–1000°. If such an oven is not at hand, the Gooch or Munroe crucible is placed in a larger platinum crucible and heated over the gas flame. The temperature is gradually raised until finally the full heat of the Teclu burner or of the blast lamp is reached. The crucible is heated until its weight is constant. $\text{Zn}_2\text{P}_2\text{O}_7$ contains 42.90 per cent. Zn.

The determination as pyrophosphate is to be recommended when the zinc solution contains a very large quantity of ammonium salts because it requires long washing to remove these and this renders the results a little low. When the precipitate is weighed as pyrophosphate, the ammonium salts are volatilized and it is not necessary to remove them by washing.

Remark.—In some cases, as when magnesium or aluminium is present, the procedure of K. Voigt is followed. The solution of the zinc salt, containing ammonium salts as well, is treated with an excess of ammonia and then with ammonium phosphate. After standing some time, the precipitate of magnesium ammonium phosphate and aluminium phosphate is filtered off, the zinc ammonium phosphate being soluble in ammonia. The filtrate is received in a platinum or porcelain dish and is heated on the water-bath until all the free ammonia has been expelled, whereby zinc ammonium phosphate separates out quantitatively in the form of the crystalline precipitate. It is treated as described above. If some of the precipitate should adhere firmly to the sides of the dish, it may be dissolved in a few drops of hydrochloric acid, the solution immediately neutralized with ammonia, and heated a few minutes on the water-bath before filtering.

2. Determination as Zinc Oxide.

The carbonate, nitrate, acetate, and oxalate of zinc are readily and quantitatively changed to zinc oxide by ignition in the air; in the case of the sulphate, when present in relatively large amounts, the transformation into oxide is difficult. Small amounts of the sulphate may be changed to oxide by igniting over the blast-lamp. It is advisable, however, in case the zinc is present as sulphate, to precipitate it from the aqueous solution as sulphide and weigh it as such according to 3; or to dissolve the sulphide on the filter in dilute hydrochloric acid, receiving the solution in a weighed platinum dish, evaporating to dryness on the water-bath, and changing to oxide by the method of Volhard as described below, and weighing as such.

The chloride is readily changed to oxide, according to Volhard, by gentle ignition with pure mercuric oxide. The process is as follows: The neutral solution of the chloride, contained in a platinum dish, is treated with a large excess of pure yellow mercuric oxide*, suspended in water, and evaporated to dryness on the water-bath, whereby mercuric chloride and zinc oxide are formed,

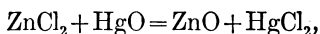

both of which are white substances. Enough mercuric oxide should be used so that the residue obtained after the evaporation is noticeably yellow.

The dry mass is ignited under a hood with a good draft (on account of the mercury vapors being poisonous), at first gently and finally strongly, and the residue of zinc oxide is weighed, both mercuric chloride and oxide being volatile. The results are excellent.

* The mercuric oxide is prepared by precipitating a solution of mercuric chloride with pure caustic potash. The precipitate is allowed to settle, washed by decantation with water until free from chloride, and kept suspended in water in a bottle with a wide neck. A considerable amount of the mercuric oxide, say 5-10 gm., should leave no weighable residue after ignition.

If the solution contains, besides zinc, also alkalis, the zinc can be precipitated as carbonate and changed to oxide upon ignition. The precipitation of the zinc carbonate should take place in a porcelain dish and the sodium carbonate solution should be added drop by drop to the cold, barely acid solution free from ammonium salts. The sodium carbonate is added until the zinc solution becomes turbid, when it is heated to boiling, whereby the greater part of the zinc is precipitated as granular zinc carbonate. Two drops of phenolphthalein solution are then added and enough sodium carbonate solution to impart a distinct pink color. In this way a precipitate of zinc carbonate is obtained free from alkali, which is not the case if the hot solution is at once precipitated by the addition of an excess of sodium carbonate.* The precipitate is filtered from the *hot* solution and washed with hot water until 20 drops of the filtrate leave no residue on evaporation. The precipitate is dried, the greater part transferred to a weighed porcelain crucible, the filter burned by itself in a platinum spiral, and the ash added to the main part of the precipitate in the crucible, which is ignited, at first gently and finally strongly, over a Teclu burner and weighed † after cooling in a desiccator.

3. Determination as Sulphide.

This determination is chosen when the zinc is present in a solution containing ammonium salts, or when it is necessary to separate zinc from alkaline earths, alkalis or metals of this group. Zinc sulphide may be precipitated from ammoniacal solutions, or from solutions containing free acetic, formic, citric, or sulphocyanic acids.

* In case considerable amounts of ammonium salts are present there may be no precipitation. Sodium carbonate should then be added until the solution is slightly alkaline and the solution boiled until all the ammonia is expelled.

† If the solution contains sulphate, the precipitate produced by sodium carbonate always contains more or less basic zinc sulphate, which may easily lead to high results. In the presence of sulphates, therefore, it is advisable to precipitate the zinc as sulphide and determine it as such according to 3..

(a) Precipitation of ZnS from Ammoniacal Solutions.

The slightly acid solution is placed in an Erlenmeyer flask and treated with sodium carbonate solution until a permanent precipitate is obtained. This is dissolved by the addition of a few drops of ammonia, after which for every 100 c.c. of the solution 5 gms. of ammonium acetate (or, better, ammonium thiocyanate) are added, followed by a slight excess of freshly prepared ammonium sulphide, the flask is nearly filled with boiled water, stoppered and allowed to stand twelve to twenty-four hours. Without disturbing the precipitate, the clear upper liquid is poured through a Schleicher & Schüll's filter No. 590. The precipitate is covered with a solution containing in every 100 c.c. 5 gms. of ammonium acetate (or ammonium thiocyanate) and 2 c.c. of ammonium sulphide solution, shaken, allowed to settle, and the turbid upper liquid is poured through the filter, taking care to receive the filtrate in a fresh beaker; in case it comes through turbid it is poured through the filter again. The decantation is repeated three times, after which the precipitate is transferred to the filter and washed completely with the above solution, taking pains to keep the filter full of the wash liquid during the entire operation, finally washing with water containing ammonium sulphide only. The precipitate is then dried, transferred as completely as possible to a weighed Rose crucible, the filter burned by itself and the ash added to the main portion of the precipitate. The precipitate is now mixed with the aid of a platinum wire, with one-third as much pure sulphur, covered with a layer of sulphur and heated, as described under Manganese (page 125) in a current of hydrogen. The crucible is finally allowed to cool in the stream of hydrogen and from the weight of the zinc sulphide the weight of zinc present is calculated,

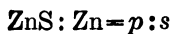

$$s = \frac{\text{Zn}}{\text{ZnS}} p;$$

and if a is the amount of the original substance, then the per cent. of zinc is

$$a : \frac{\text{Zn}}{\text{ZnS}} \cdot p = 100 : x$$

$$x = \frac{100 \text{ Zn}}{\text{ZnS}} \cdot \frac{p}{a} = \% \text{ zinc.}$$

(b) *Precipitation of ZnS from Acid Solutions.*

The solution, which has been nearly neutralized with ammonia, is treated with ammonium chloride or sulphate and a little ammonium or sodium acetate; and is then saturated with hydrogen sulphide. After the precipitate has settled completely, the supernatant solution is poured through a filter, and the precipitate washed with 2 to 4 per cent. acetic acid which has been saturated with hydrogen sulphide. When thoroughly washed it is treated as described above. It is to be noted that the zinc sulphide shows less tendency to form colloidal solutions when it is thrown down from a slightly acid solution than when it is precipitated from alkaline solutions.

4. Electrolytic Determination of Zinc.

In the presence of acid, zinc is not deposited by an electric current of 0.5 to 1 ampere, although it may be deposited even then by stronger currents.

From the solution of potassium or sodium zincate, or from the complex alkali zinc cyanides, it is easy to deposit the zinc quantitatively.

(a) *Method of F. Spitzer.**

The solution of zinc sulphate (chlorides and nitrates should be absent) is treated with a drop of phenolphthalein and with sodium hydroxide solution until a permanent coloration is obtained. Then 20 to 25 c.c. of normal caustic soda solution are added, the

* Z. Elektrochem., 11, 401 (1905).

solution is diluted to 150–200 c.c. and electrolyzed, using a platinum gauze cathode, with a current of 0.8 to 1 ampere and 3 to 4 volts electrode potential. At the end of three hours the electrolysis is finished, provided not more than 0.5 gm. of zinc was present. Without breaking the current, the electrodes are raised nearly out of the bath, the upper portions are washed quickly with water, then the electrodes are taken entirely out of the solution and rinsed with water. The current is then turned off, the cathode washed with absolute alcohol, dried above a flame, cooled in a desiccator, and weighed. When deposited in this way, zinc forms a bluish-gray layer that adheres firmly to the electrode. To make sure that all the zinc was deposited, the electrodes are cleaned and the solution electrolyzed for thirty minutes longer. A slight increase in weight will be obtained in every case because the anode is attacked slightly by the alkaline solution so that the cathode slowly continues to gain in weight from deposited platinum. If at the end of half an hour the gain in weight is not over 0.3 mg. then the deposition of the zinc was complete the first time, as can be shown by testing with sodium sulphide. The results are always a little high.*

To clean the electrodes, they are boiled thoroughly with hydrochloric acid (1:2) washed well with distilled water, and ignited. It is not necessary to cover the platinum gauze with a thin coating of copper or of silver, as has been recommended when a platinum dish is used as the cathode.

Remark.—If too little caustic soda is present, a spongy deposit of zinc is obtained which does not adhere well to the electrode. For this reason the above directions should be followed closely.

In the presence of ammonia the determination is not successful. If, therefore, it is desired to analyze a solution containing an ammonium salt, it must be boiled with caustic soda until all the ammonia has been expelled. If, moreover, chlorides or nitrates

* Ellwood B. Spear, *J. Am. Chem. Soc.*, **32**, 530 (1910). The experiments have been repeated in the author's laboratory by Janini, who obtained as an average from fourteen determinations with 50 c.c. of a zinc sulphate solution, the value 0.1014 gm. Zn instead of 0.1008 gm. Zn, a difference of about 0.6 per cent.

are present they must be removed by evaporation with sulphuric acid. The solution is evaporated on the water-bath and finally heated over the free flame until dense vapors of sulphuric acid are expelled. The solution is then diluted and analyzed in the usual manner.

(b) **The Potassium Cyanide Method.***

A drop of phenolphthalein is added to the solution of zinc sulphate, caustic soda solution until a permanent pink coloration is obtained, and then potassium cyanide solution until a clear solution results. This is diluted to a volume of 150–200 c.c. and electrolyzed with a current of 0.5 ampere. At first the electrode potential is about 5.8 volts, but it falls during the analysis on account of the current heating the solution. The electrolysis is finished in two or three hours.

Other methods for the electrolytic estimation of zinc are given in A. Classen's book *Quantitative Analysis by Electrolysis*.

**SEPARATION OF MANGANESE, NICKEL, COBALT, AND ZINC
FROM THE ALKALINE EARTHS.**

The separation depends upon the insolubility of the sulphides of the metals of this group and the solubility of the sulphides of the alkaline earths.

Procedure.—The neutral solution of the chlorides, contained in an Erlenmeyer flask, is treated with ammonium chloride (in case it is not already present) and freshly-prepared colorless ammonium sulphide solution is added drop by drop until no further precipitation takes place and the liquid has a distinct odor of ammonium sulphide. The flask is then almost completely filled with boiled water, corked, and allowed to stand twelve hours. The precipitate is filtered and washed as described in the Determination of Zinc (p. 144).

If only a small amount of alkaline-earth metals are present and

† Luckow, Z. anal. Chem., 19, 1 (1880).

the ammonium sulphide solution is entirely free from ammonium carbonate, the separation is usually complete after one precipitation; in the presence of considerable calcium, strontium, barium, or magnesium the sulphide precipitate will always be more or less contaminated with these substances, so that the precipitation must be repeated. For this purpose the washed precipitate is dried, transferred as completely as possible to a porcelain crucible, the filter-paper burned in a platinum spiral and the ash added to the main part of the precipitate in the crucible, which is now covered with a watch-glass, treated with dilute hydrochloric acid, and heated to boiling after the evolution of hydrogen sulphide has ceased, in order to remove all of the hydrogen sulphide. A very little concentrated nitric acid is now added and the mixture warmed until the precipitate is completely dissolved; the solution is evaporated to dryness, treated with a little concentrated hydrochloric acid, and again evaporated to dryness in order to change to chloride any nitrate that may have been formed. The dry mass is moistened with a few drops of concentrated hydrochloric acid, dissolved in hot water, and the slight residue of sulphur filtered off, which, in case barium is present, always contains a small amount of barium sulphate, and is therefore washed with hot water, dried, ignited in a porcelain crucible, and weighed. The filtrate is then precipitated exactly as before by the addition of ammonium sulphide.

In case nickel is present, a too great excess of ammonium sulphide must be carefully avoided, as otherwise the nickel sulphide will pass through the filter (cf. Vol. I). In all cases, however, the filtrate should be tested for nickel by acidifying with acetic acid, heating to boiling, and passing hydrogen sulphide into the solution. If a slight black precipitate is produced by this treatment, it is filtered off and combined with the main precipitate (cf. p. 156 et seq). The filtrate containing the alkaline-earth metals is freed from ammonium salts by evaporating to dryness, dissolved in hydrochloric acid, and examined as described on p. 76 et seq.

Remark.—The ammonium sulphide solution used in the above separation must be free from ammonium carbonate. As, however, all commercial ammonia contains this salt, it must be freed from

carbonate before being used for the preparation of ammonium sulphide solution.

Preparation of Ammonia Free from Carbonate.*

About 10 gms. of freshly slaked lime are added to 500 c.c. of concentrated ammonia contained in a liter flask that is connected with a condenser. The condenser is closed by means of a tube containing soda-lime, and the contents of the flask are allowed to stand for a day with frequent shaking. After this, from 300–400 c.c. of water are placed in a flask and boiled, meanwhile passing through the water a current of air that has been freed from all traces of carbon dioxide by passing through concentrated caustic potash solution and then through a tower filled with soda-lime. The water is allowed to cool in this air-stream. The flask containing the ammonia is then placed on the water-bath in such a position that the condenser-tube is inclined slightly upward, and this is connected with the delivery-tube, through which the air previously passed into the flask of boiling water. By warming the water-bath the ammonia is now distilled over into the flask containing the boiled water, by which it is completely absorbed. By saturating a part of this ammonia with hydrogen sulphide, a solution of ammonium sulphide is prepared suitable for the above-described separation.

SEPARATION OF THE BIVALENT FROM THE OTHER METALS OF THE AMMONIUM SULPHIDE GROUP.

This separation is often designated as that of the *protoxides* from the *sesquioxides*; this designation is not applicable in the case of titanium and uranyl derivatives.

The Barium Carbonate Method.

This method depends upon the fact that ferric, aluminium and chromic salts (as well as titanous and uranyl salts) are precipitated.

* The distillation of ammonia also serves to free it from silica, which it always contains when kept in glass bottles for any length of time.

pitated in the cold by barium carbonate, while manganese, nickel, cobalt, zinc, and ferrous salts are not. Salts of the trivalent metals undergo hydrolysis when in dilute aqueous solution:

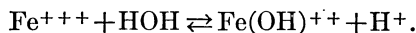

Free acid and a basic salt are formed by this hydrolysis, the composition of the latter depending upon the quantity of the water and the temperature. If the free acid is removed by the addition of barium carbonate, the equilibrium is disturbed and the hydrolysis goes further until finally the insoluble hydroxide is formed:

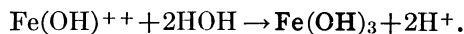

The barium carbonate, then, serves only to neutralize the acid set free by the hydrolysis, and the total reaction is expressed by the following equation:

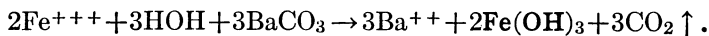

The salts of the bivalent metals are not subject to this hydrolysis *in the cold*, consequently they are not precipitated by the addition of barium carbonate. On warming, however, they are hydrolyzed to an appreciable extent and are then precipitated by barium carbonate.

Procedure.—Sodium carbonate solution is added drop by drop to the slightly acid solution of the chlorides or nitrates, but not the sulphates,* of the metals, in an Erlenmeyer flask until a slight, permanent turbidity is produced, which is then redissolved by the addition of a few drops of dilute hydrochloric acid. The solution is diluted and treated with pure barium carbonate † (suspended in water) until after thoroughly shaking an excess of the

* Barium carbonate will precipitate the bivalent metals when sulphates are present, e.g.:

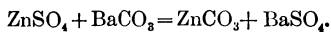

† The barium carbonate must be free from alkali carbonate.

latter remains on the bottom of the flask. The flask is closed and allowed to stand for several hours with frequent shaking. The clear liquid is then decanted off, the residue treated with cold water and again decanted. This decantation is repeated three times, after which the precipitate is transferred to the filter and completely washed with cold water. The precipitate contains all of the iron, aluminium, chromium, titanium, and uranium in the presence of the excess of barium carbonate. The filtrate contains the bivalent metals and barium chloride.

The precipitate is dissolved in *dilute* hydrochloric acid, boiled to remove the carbon dioxide, and the iron, aluminium, chromium (titanium and uranium) are separated from the barium* by double precipitation with ammonium sulphide as described on p. 147. The iron, aluminium, chromium (titanium and uranium) are separated from one another as described on pp. 107-120.

The filtrate from the barium carbonate precipitation is freed from barium by the addition of sulphuric acid † to the boiling solution after it has been made acid with hydrochloric acid. The barium sulphate is filtered off and the monoxides are separated from one another as described on p. 156.

Remark.—The above separation of the sesquioxides from the protoxides is not absolutely certain in the presence of nickel and cobalt. In this case, particularly when considerable iron is present, the precipitate produced by barium carbonate contains small amounts of nickel and cobalt. This difficulty can be overcome, however, by adding ammonium chloride to the solution (3-5 gms. for each 100 c.c. of solution) before precipitating with barium carbonate; the separation is then satisfactory.

* Most authorities recommend precipitating the barium first with sulphuric acid and then separating the iron, aluminium, etc. The precipitate of barium sulphate always contains small amounts of the heavy metals, so that the author prefers the above procedure.

† Or, better, by double precipitation of the other metals with ammonium sulphide.

SEPARATION OF IRON, ALUMINIUM, AND TITANIUM (BUT NOT CHROMIUM AND URANIUM) FROM MANGANESE, NICKEL, COBALT, AND ZINC.

Basic Acetate Method.

This classic method depends upon the fact that ferric, aluminium and titanium acetates are hydrolyzed in hot, dilute solutions much more readily than the acetates of the bivalent metals. From the equation



it is evident that acid is set free which tends to stop the reaction, due to the solvent action of hydrogen ions. The concentration of free hydrogen ions, however, is kept low by the addition of sodium acetate. Then, as a rule, some manganese is likely to be precipitated, so that it is advisable to dissolve the precipitate and repeat the precipitation. Hydrated manganese dioxide is more insoluble than manganous hydroxide, $\text{Mn}(\text{OH})_2$, and hence long boiling in the air tends to increase the quantity of manganese precipitated. The method is somewhat tedious, but gives excellent results.

Procedure.—The slightly acid solution of the *chlorides*, contained in a small beaker, is treated with sodium carbonate solution in the cold until a slight permanent opalescence is obtained, which is then redissolved by the addition of a few drops of dilute hydrochloric acid. Meanwhile a boiling, dilute solution of sodium or ammonium acetate is prepared in a large round-bottomed flask, containing for each 0.1 to 0.2 gm. of iron or aluminium, 1.5 to 2 gm. of acetate and 300 to 400 c.c. water. When the iron solution is ready, the lamp is taken away from beneath the flask, the iron solution is added, and then the boiling is continued for one minute, the flame removed (the precipitate becomes slimy on long boiling), the precipitate allowed to settle and filtered immediately while the liquid is hot, through a fluted filter, washing three times by decantation with boiling water containing ammonium or sodium acetate. The filter together with the precipitate is spread upon a glass plate, the bulk of the precipitate rinsed into a porcelain dish, and that remaining or

the filter dissolved by alternately treating with concentrated hydrochloric acid and hot water. The resulting solution is evaporated nearly to dryness on the water-bath and the basic acetate precipitation is repeated exactly as before. The filtered and washed precipitate is dissolved in hydrochloric acid and the iron separated from aluminium according to page 107. The combined filtrates containing the protoxides are acidified with 10–20 c.c. of concentrated hydrochloric acid, in order to prevent the precipitation of hydrated manganese dioxide, evaporated almost to dryness, dissolved in a little water, the manganese, nickel, cobalt and zinc precipitated by ammonium sulphide as described on p. 147, and analyzed according to p. 156.

Remark.—This procedure requires practice. It is especially suited for the separation of iron and titanium from the protoxides; the separation is usually less satisfactory with aluminium, so that in case considerable amounts of the latter are present, the barium carbonate separation is to be preferred. If it is merely a case of the

Separation of Iron from Manganese,

the following modifications of the basic acetate process give satisfactory separations with only a single precipitation.

(a) O. Brunck's Method.*

The acid solution, containing not more than 0.3 gm. of iron, is treated with 0.35 gm. of potassium chloride or 0.26 gm. ammonium chloride for each 0.1 gm. of iron present. The solution is evaporated to dryness on the water-bath, the residue pressed with a glass rod, and heated five or ten minutes longer. By this time practically all the mineral acid is expelled. The residual salts are dissolved in 10 to 20 c.c. of water and to the resulting solution there is added 1.5 gm. of sodium acetate for each 0.1 gm. of iron present.† The solution is diluted with boiling water to a volume of 400 to 500 c.c. for each 0.2 gm. of iron present; it is heated, with constant stirring, until boiling begins, and then

* Chem. Ztg., 1904, I, 513. Cf. W. Funk, Z. anal. Chem., 45, 181 (1906).

† The sodium acetate crystals often contain a little sodium carbonate, so that they should be dissolved in a little water and the solution made barely acid before adding it to the iron solution.

the flame is removed and the precipitate allowed to settle. The solution is decanted through a fluted filter and the precipitate washed with hot water. The precipitate is dissolved in as little hydrochloric acid as possible, the iron precipitated by ammonia, filtered, dried, and ignited as described on page 87. The filtrate from the basic acetate precipitation, or better the combined filtrates from both precipitations,* is acidified with hydrochloric acid, evaporated nearly to dryness, the residue dissolved in a little water and the manganese, nickel, cobalt and zinc precipitated with ammonium sulphide according to the directions on page 147, and separated according to page 156.

(b) Method of A. Mittasch.†

The slightly acid solution, containing not more than 0.3 gm. of iron and having a volume of not over 100 c.c., is carefully neutralized, while stirring constantly, by adding ammonium carbonate solution (200 gm. of the commercial salt in 1 liter of water) from a pipette or burette. When the precipitate that is first produced begins to dissolve very slowly, the neutralization is finished with an ammonium carbonate solution, which is prepared by taking 50 c.c. of the first solution and diluting to 1 liter, the dilute reagent being added until the precipitate produced will not dissolve within one or two minutes of stirring. At this point, 3 c.c. of double normal acetic acid are added, and the solution stirred until the precipitate disappears. The solution is diluted with 400 c.c. of hot water and heated until it begins to boil, when the greater part of the iron will have been precipitated. Then 20 c.c. of ammonium acetate solution (60 gm. of the commercial salt in 1 liter of water)‡ are added and the boiling continued for

* The ammoniacal filtrate from the $\text{Fe}(\text{OH})_3$ precipitate is acidified with 5 c.c. of concentrated hydrochloric acid before adding it to the filtrate from the basic acetate precipitation, otherwise manganese is likely to be precipitated when the two filtrates are mixed.

† Z. anal. Chem., 42, 508 (1903).

‡ Commercial ammonium acetate has the symbol $\text{NH}_4\text{C}_2\text{H}_3\text{O}_2 \cdot \text{HC}_2\text{H}_3\text{O}_2$. If none of it is on hand, 100 c.c. 2N. ammonium hydroxide are mixed with 50 c.c. 2N. acetic acid; the mixture must be faintly acid. Of this solution 10 c.c.+5 c.c. 2N. acetic acid are used for the precipitation of the iron, and 10 c.c. of 2N. acetic acid are added to dissolve the precipitate produced by ammonium carbonate.

a minute longer. Without waiting for the precipitate to settle, it is filtered off and washed with hot water until free from chlorides.

The small quantity of precipitate adhering to the sides of the vessel in which the precipitation took place is dissolved in a few drops of hydrochloric acid, the iron precipitated by ammonia and the ferric hydroxide filtered off through a separate filter. Both filters are now dried, burned and the iron weighed as Fe_2O_3 .

SEPARATION OF IRON AND ALUMINIUM FROM MANGANESE, NICKEL, COBALT, AND ZINC.

Sodium Succinate Method.

This method, applicable for the separation of large quantities of iron from small quantities of manganese, nickel, etc., is based upon the fact that ferric iron is quantitatively precipitated from *neutral* solutions as light-brown ferric succinate by the addition of neutral alkali succinate solution, while manganese, nickel, etc., remain in solution.

Procedure.—In case the solution contains free acid and all the iron is in the ferric form, it is neutralized with ammonia until a reddish-brown coloration is formed, when sodium or ammonium acetate is added until the color becomes a deep brown, and then the solution of alkali succinate, after which the mixture is warmed gently, allowed to cool, filtered, and washed at first with cold water, then with warm water containing ammonia, until 20 drops of the filtrate leave no residue when evaporated to dryness on platinum. By means of the washing with ammonia, the ferric succinate is changed to ferric hydroxide which is dried and weighed as ferric oxide after ignition in a porcelain crucible. If aluminium is present, the ignited residue is further analyzed as described on p. 107. The bivalent metals in the filtrate are best precipitated by the addition of ammonium sulphide and analyzed as follows:

SEPARATION OF THE BIVALENT METALS OF THE AMMONIUM SULPHIDE GROUP FROM ONE ANOTHER.

Separation of Zinc from Nickel, Cobalt, and Manganese.

All methods for this separation rest upon the slight solubility of zinc sulphide and the ready solubility of the remaining sulphides in their state of formation.* At this point it may be well to say a few words with regard to the most recent explanation of the process that takes place in the solution of electrolytes.

Solubility Product.

Inasmuch as *no* substance is *absolutely* insoluble in water, it follows that in every case where a precipitate is produced the solution is saturated with the substance and (according to Ostwald) in the case of difficultly soluble substances the dissolved portion is practically completely dissociated electrolytically. The binary substance *A*, consisting of the elements *B* and *C*, is decomposed in aqueous solution according to this scheme;

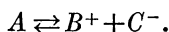

If the concentrations of the ions B^+ and C^- are designated by $[B]$ and $[C]$, and that of the undissociated portion by $[A]$, then according to the mass-action law the following relation holds for any given temperature:

$$\frac{[B] \cdot [C]}{[A]} = \text{constant.}$$

Every increase of $[B]$ or $[C]$ causes, therefore, an increase of $[A]$, and, as the solution is already saturated with *A*, this will produce precipitation of the substance.

This product $[B \cdot C]$, † which if exceeded causes a supersaturation of the solution, and consequently precipitation, is called the

* Nickel and cobalt sulphides when once formed are insoluble in dilute acids. These substances probably exist in two allotropic modifications, of which one is soluble and the other insoluble. The soluble form has never been isolated.

† This is the value of the numerator in the mass action expression when the solution is saturated with the substance *A*.

solubility product. If, therefore, in any solution the solubility product is already reached, then the solution is saturated with respect to the substance A, and if the solubility product is not reached, then the liquid exerts a solvent action upon the solid substance.

Explanation of the Solution of Sulphides in Acids.

According to the above theory, the solution of a sulphide (e.g. zinc sulphide) in acid is conceived to take place as follows:

On treating the solid sulphide with water, a part of the salt is dissolved until the solubility product is reached. This almost inappreciable amount is practically completely dissociated into ions. On adding acid to the solution, the positive hydrogen ions unite with the negative sulphur ions to form neutral hydrogen sulphide, which being a very weak acid is only dissociated to a slight extent, so that sulphur ions disappear from the solution and the solubility product of zinc sulphide is no longer reached:

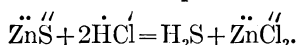

The liquid, therefore, dissolves more of the solid zinc sulphide and the above reaction again takes place and this process is repeated until all of the zinc sulphide is brought into solution. The solubility of a sulphide in acid, therefore, is proportional to its solubility product and to the concentration of the hydrogen ions. If we, then, desire to precipitate zinc by means of hydrogen sulphide from a neutral solution of an inorganic compound, the following consideration shows us how this may be accomplished: If hydrogen sulphide is conducted into a solution containing zinc combined with a mineral acid, the zinc is indeed precipitated, but as the amount of zinc sulphide formed increases, there is an increase in the concentration of the hydrogen ions:

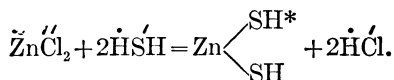

The precipitation is, therefore, incomplete. It can be made complete, however, if we can avoid this increase in the concentra-

* The $\text{Zn}(\text{SH})_2$ is at once decomposed into ZnS and H_2S .

tion of the hydrogen ions. This can take place by replacing the mineral acid formed by a weaker acid, i.e. one which is only slightly dissociated, so that the solution will contain fewer hydrogen ions.*

The following methods depend upon this principle.

Method of Smith and Brunner.†

Procedure.—The hydrochloric acid solution of the four metals is treated with sodium carbonate until a permanent precipitate is formed, which is redissolved by the addition of a few drops of very dilute hydrochloric acid. Into this almost neutral solution hydrogen sulphide is passed for five minutes, then a few drops of a very dilute solution of sodium or ammonium acetate are added and the solution is saturated with hydrogen sulphide, allowed to stand overnight, filtered, and washed with hydrogen sulphide water which contains in every 100 c.c. 2 gms. of ammonium salt (either the chloride, sulphate, or sulphocyanate). The zinc is then determined either as oxide or sulphide according to the methods described on pp. 142 and 143.

Remark.—Inasmuch as the exact amount of acid to be set free is unknown, it is impossible to tell exactly how much alkali acetate is necessary, and herein lies the chief difficulty. If too much alkali acetate is added, some nickel or cobalt sulphide may be precipitated (shown by the gray color of the zinc precipitate). If not enough alkali acetate is added, the zinc will not be completely precipitated. The following separation is more certain.

Method of Cl. Zimmerman.‡

Procedure.—The weakly acid solution is treated with sodium carbonate solution until a permanent precipitate is formed, which is redissolved by the addition of a few drops of very dilute hydrochloric acid, then for every 80 c.c. of the solution 10, or at the most 15, drops of double-normal hydrochloric acid,§ and 10 c.c. of

* Concerning the equilibrium conditions in the precipitation of sulphides by hydrogen sulphide, see Bruner and Zawadzki, *Chem. Zentr.*, 1910, 5.

† *Chem. Centrabl.*, 1895, 26.

‡ *Ann. d. Chem. u. Pharm.*, 199, (1879) p. 3; 204 (1880), p. 226.

§ The addition of hydrochloric acid is in all cases necessary, because otherwise nickel sulphide will be precipitated with the zinc sulphide, especially when considerable nickel and little zinc are present.

ammonium sulphocyanate (1:5) solution are added, after which the solution is heated to about 70° C. and is saturated with hydrogen sulphide. At first the solution becomes only slightly turbid,* but after some time pure white zinc sulphide is thrown down in clouds, constantly becoming denser. After the solution has become saturated with hydrogen sulphide, the beaker is covered and allowed to stand in a moderately warm place until the precipitate has settled and the upper liquid is clear, after which the precipitate is filtered and washed, as described in the method of Smith and Brunner.

From the filtrate nickel, cobalt, and manganese are precipitated by means of ammonium sulphide, filtered and separated according to the following methods.

Remark.—What is the part played by the ammonium sulphocyanate in this determination? Certainly it cannot act the same as the ammonium acetate in the Smith-Brunner method, for sulphocyanic acid is not, like acetic acid, a weak acid, but a very strong one, almost as strong as hydrochloric acid itself, and the dissociation of strong acids is only slightly influenced by the addition of their neutral salts.

Ammonium sulphocyanate probably simply “salts out” the zinc sulphide (cf. Vol. I).

By the action of hydrogen sulphide upon the zinc salt, zinc sulphide is produced both in the hydrogel and hydrosol forms and the ammonium sulphocyanate changes the latter into the insoluble hydrogel. If this explanation is correct, the separation of zinc from nickel, etc., will succeed equally well if the ammonium sul-

* There are at the start but few zinc ions in the solution. The four metals are present for the most part in the form of complex thiocyanates of the general formula $[R(CNS)_4](NH_4)_2$. The zinc salt, like carnallite (see Vol. I) is slightly dissociated,

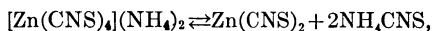

and the zinc thiocyanate is converted into insoluble sulphide by the action of hydrogen sulphide. When the zinc begins to precipitate as sulphide, the equilibrium is disturbed and eventually all the zinc becomes precipitated.

phocyanate is replaced by ammonium chloride or ammonium sulphate. That this is the case is shown by the following method.

“Salting-out Method.”

Experiments were performed by G. H. Kramers in order to determine whether the separation of zinc from nickel and cobalt could be accomplished in weakly acid solutions by hydrogen sulphide after the addition of any ammonium salt of a strong acid.* The results obtained showed this to be possible.

Procedure.—The neutral solution † containing the nickel and zinc either in the form of sulphate or chloride (the sum of the oxides present amounting to about $\frac{1}{4}$ per cent. of the weight of the solution) is treated with 8–10 drops of double-normal hydrochloric acid and about 2 per cent. of ammonium sulphate (referred to the total amount of liquid) and the solution is saturated at 50° C. with hydrogen sulphide; the warm solution is allowed to stand until the pure white precipitate of zinc sulphide has settled out and is then treated exactly as described under the Method of Zimmerman.

Results.—In the following experiments a zinc sulphate solution containing 5.890 gms. zinc to the liter and a solution of nickel sulphate containing 5.320 gms. nickel to the liter were used.

	c.c. $ZnSO_4$.	c.c. $NiSO_4$.	c.c. H_2O .	Drops 2N. HCl.	c.c. NH_4CNS 1:5.	c.c. $(NH_4)_2SO_4$ 1:5.	c.c. NH_4Cl 1:5.	Wt. of Zn Found.	Wt. of Zn Calculated.	Wt. of Ni Found.	Wt. of Ni Calculated.
NH_4CNS	20	20	3	5	0.1188	0.1178	0.1072	0.1066
	50	20	3	5	0.3533	0.3534	0.1051	0.1066
	20	60	10	10	0.1184	0.1178	0.3206	0.3192
	60	60	15	10	0.1182	0.1178
	20	60	30	10	0.1089	0.1178
$(NH_4)_2SO_4$	20	20	5	5	0.1173	0.1178
	50	20	6	10	0.3536	0.3534	0.1082	0.1066
	20	60	12	10	0.1184	0.1178
	60	60	12	20	0.1168	0.1178
	20	20	60	8	5	0.1184	0.1178	0.1064	0.1066
NH_4Cl	20	20	110	8	10	5	0.1182	0.1178	0.1074	0.1066
	60	20	110	8	10	10	0.3552	0.3534
	20	60	100	24	20	20	0.1190	0.1178

* Or any other salt, e.g., a potassium salt.

† If the solution is acid, it is neutralized by sodium carbonate as described under the preceding methods.

Separation of Manganese from Nickel and Cobalt.

The solution of the chlorides or sulphates is treated with an excess of sodium carbonate, strongly acidified with acetic acid, and for each gram of nickel or cobalt present 5 gms. of ammonium acetate are added, the solution is diluted to 100–200 c.c., heated to 70–80° C., saturated with hydrogen sulphide, filtered, and washed with hot water. The manganese is in the filtrate, and the nickel and cobalt are in the precipitate.

Remark.—The filtrate often contains small amounts of nickel and cobalt. In order to remove these metals, the solution should be concentrated and colorless ammonium sulphide added. It is then made slightly acid with acetic acid, warmed, and filtered. In case a precipitate of nickel or cobalt sulphides is formed by this treatment, the filtrate is again tested in the same way and the process repeated until no further precipitation is produced.

Separation of Cobalt from Nickel.

(a) Method of Tschugaeff-Brunck.*

This method is probably the quickest and most accurate for the estimation of nickel in the presence of cobalt. It depends upon the fact that nickel is quantitatively precipitated by means of dimethyl glyoxime, from a barely ammoniacal solution or from a slightly acid solution containing sodium acetate. Cobalt, under these conditions, is not precipitated.

Procedure.—If the quantity of cobalt present does not exceed the quantity of nickel, the procedure is exactly the same as when nickel alone is present; with larger quantities of cobalt two or three times as much of the dimethyl glyoxime reagent is added and the precipitation is accomplished exactly as described on page 129. For the determination of both nickel and cobalt, the original solution is divided into two portions. In one portion the nickel is determined as outlined above, and in the other the two elements are deposited electrolytically as described on page 136, and the cobalt found by difference. If only a little of the substance is available, the two metals are deposited

* O. Brunck, Z. angew. Chem., 1907, 1848.

together by electrolysis, the weighed deposit dissolved in nitric acid (the electrodes must be completely immersed in the acid and the solution boiled for at least 20 minutes), the resulting solution concentrated to a small volume, and the nickel determined as described above. The method can be recommended strongly.

(b) **The Potassium Nitrite Method of N. W. Fischer.***

Brunck's Modification.†

The solution containing an excess of acid is evaporated to dryness in a porcelain dish and the residue treated with one or two drops of dilute hydrochloric acid and 5 to 10 c.c. of water. Pure caustic potash solution is then added drop by drop until the reaction is barely alkaline. The resulting precipitate is dissolved in as little glacial acetic acid as possible, half of the solution's volume of 50 per cent. potassium nitrite solution is added, and 10 drops more of acetic acid; the mixture is stirred well and allowed to stand twenty-four hours. At the end of this time the precipitation is almost always complete. It should be tested, however, by removing a little of the undiluted solution with a pipette, adding to it a little more potassium nitrite solution, and allowing to stand a little longer. If at the end of an hour no further precipitation results, then all the cobalt has been precipitated. If a precipitate is formed, the whole solution is treated with more potassium nitrite and again allowed to stand. The clear liquid is poured through a filter, the residue transferred to the filter and washed with a 10 per cent. potassium acetate solution until 1 c.c. of the filtrate on being acidified with acetic acid and boiled with 1 c.c. of a 1 per cent. solution of dimethyl glyoxime will show no test for nickel. This is usually the case after washing four times. As much of the precipitate as possible is now transferred to a small porcelain dish, which is covered with a watch-glass, cautiously acidified with sulphuric acid, and heated on the water-bath until no more brown vapors are evolved.

* Pogg. Ann., 71, 545 (1847).

† Z. angew. Chem., 1907, 1847.

The small quantity of precipitate remaining on the filter is dissolved by pouring hot, dilute sulphuric acid through the filter and this acid is added to the main solution of the cobalt. After evaporating as far as possible on the water-bath, the heating is continued on an air-bath until dense vapors of sulphuric acid are evolved. After cooling, the residue is dissolved in water and the cobalt determined electrolytically, as described on p. 138. If it is not convenient to carry out an electrolysis, the nitrite precipitate is dissolved in hydrochloric acid and the cobalt determined according to p. 139 (b).

The filtrate containing the nickel can be treated with hydrochloric acid until the nitric acid is completely decomposed, and the nickel then precipitated as black nickelic hydroxide by caustic potash and bromine water, filtered, washed, and weighed as the oxide, according to p. 137.

Remark.—This method gives reliable results provided the solution is free from alkaline earths. In the latter case the nickel and alkaline-earth metals are precipitated with the cobalt. (Cf. Vol. I.)

(c) Liebig's Potassium Cyanide Method.*

This method is based upon the different behavior of the complex cyanogen compounds of both metals towards bromine or chlorine in alkaline solution. (Cf. Vol. I.)

Procedure.—The neutral solution, which may contain only nickel, cobalt, and the alkalies, is treated with an excess of purest 98 per cent. potassium cyanide and 5 gm. of pure potassium hydroxide, after which bromine water is added, with constant stirring, until no more nickelic hydroxide is precipitated. Care must be taken that the solution remains strongly alkaline until the end of the process; upon this point depends the success of this excellent method. When the precipitation is complete, the solution is diluted with cold water and the nickel determined as oxide, as described on p. 137.

The cobalt remains in the filtrate as potassium cobalticyanide. After the addition of dilute sulphuric acid, the solution is evapo-

* Ann. d. Chem. u. Pharm., 65, 244; 87, 128.

rated as far as possible on the water-bath, a little concentrated sulphuric acid is added, and the residue is heated over a free flame until dense, white fumes are evolved and the effervescence has ceased:

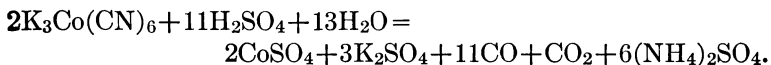

The cold, blue mass is dissolved in water and the cobalt deposited electrolytically; or, the cobalt may be precipitated by the addition of bromine water and potassium hydroxide, filtered, dried and determined as metal according to p. 139.

(d) **Liebig's Mercuric Oxide Method.**

In this method advantage is taken of the fact that potassium nickelocyanide, like almost all other complex cyanogen compounds, is decomposed by mercuric oxide, whereas potassium cobaltcyanide, on the contrary, is unaffected:

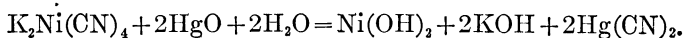

Procedure.—A slight excess of pure potassium cyanide is added to the neutral solution, which is then heated on the water-bath for at least one hour in order to change the potassium cobaltcyanide to potassium cobaltcyanide (cf. Vol. I). The solution is then treated with a suspension of mercuric oxide in water and heated for a long time, with frequent stirring, upon the water-bath. The decomposition is complete after one or two hours. The solution is diluted somewhat with hot water, and the precipitate, consisting of nickelous hydroxide and the excess of mercuric oxide, is filtered off, dried, ignited under a hood with a good draft, and the residue of nickel oxide weighed as described on p. 137. It is better, however, to dissolve the nickel oxide in sulphuric acid and determine it electrolytically according to p. 136, or as the salt of dimethyl glyoxime, according to p. 129.

The filtrate containing potassium cobaltcyanide and mercuric cyanide is treated with sulphuric acid exactly as described under (b) and the cobalt determined as metal, preferably by electrolysis.

The author has also tested and found satisfactory the method of Ilinsky and Knorre,* but it seems to have no advantages over the above-described procedures.

Recently Rosenheim and Huldshinsky † have applied Vogel's qualitative test for cobalt (cf. Vol. I, under *Cobalt*) to the quantitative separation of this metal from nickel, and have obtained excellent results.

Separation of Nickel from Zinc. Method of Tschugaeff-Bruck. ‡

The solution is treated with ammonium chloride, and enough ammonia to make it slightly ammoniacal; no precipitate will be formed if sufficient ammonium chloride has been added. The solution is then just acidified with hydrochloric acid, heated to boiling and the nickel precipitated with an alcoholic 1 per cent. dimethyl glyoxime solution exactly as outlined on p. 129.

In the filtrate, it is best to precipitate the zinc as sulphide by acidifying with acetic acid and saturating the hot solution with hydrogen sulphide (cf. p. 145).

Remark.—When considerable zinc is present it is necessary to add more dimethyl glyoxime to precipitate the nickel.

Separation of Nickel from Manganese. Method of Tschugaeff-Bruck. §

The analysis is carried out exactly as described above with the only difference that the final precipitation takes place in an acetic acid solution. The greater part of any mineral acid present is neutralized carefully with ammonia, the barely acid solution is treated with 1 per cent. dimethyl glyoxime solution and then, after the precipitate has formed, sodium acetate is added and the analysis continued according to p. 129. If the alkali acetate is added before the dimethyl glyoxime, a very voluminous precipitate is formed which, to be sure, can be filtered

* Berichte, 18, 669.

† *Ibid.*, 31, 2050.

‡ Z. angew. Chem., 1907, 1849.

§ *Ibid.*

with suction, but even then the filtration is tedious. Thus when possible it is best to add the sodium acetate after the dimethyl glyoxime. When, on the other hand, iron has been removed by a basic acetate separation and nickel and manganese are to be determined in the filtrate, the precipitation must take place in a solution already containing sodium acetate. In the filtrate from the nickel dimethyl glyoxime precipitation, the manganese is precipitated with ammonium sulphide and determined as described on p. 125.

Separation of Nickel from Iron.

If the iron is present in the ferrous condition it is oxidized by boiling with nitric acid. Then from 1 to 3 gm. of tartaric acid are added and the solution made slightly ammoniacal in order to find out whether enough tartaric acid has been added (the solution must remain perfectly clear). After making barely acid with hydrochloric acid, the nickel is precipitated with dimethyl glyoxime, the acid just neutralized with ammonia, and the analysis continued according to p. 129.

Determination of Nickel in Steel.*

The sample, weighing about 0.5 gm., is dissolved in 10 c.c. of concentrated hydrochloric acid, enough nitric acid is added to completely oxidize the iron, and if there is any separation of silica at this point some hydrofluoric acid is added. Two or three gms. of tartaric acid are introduced, and the solution diluted to a volume of 300 c.c. It is then carefully tested to see whether enough tartaric acid is present to prevent any precipitation of iron when the solution is made alkaline with ammonia, more tartaric acid being added if necessary. The solution, which is left *slightly* acid, is heated nearly to boiling and treated with 30 c.c. of a 1 per cent. alcoholic solution of dimethyl glyoxime. The acid is finally very carefully neutralized with ammonia, leaving the solution so that it barely smells of this reagent. After allowing the solution to stand for a few minutes, 10 c.c. more of reagent are added to see if further precipitation takes place and the treatment is repeated if necessary. The solution is allowed to stand in a warm place for an hour and it is then allowed to cool for about half an hour. Finally the solution is filtered through

* O. Brunck, Stahl und Eisen, 28, 331.

a Gooch or Munroe crucible, washed with hot water, dried at 110°–120° for 45 minutes and weighed as $\text{Ni}(\text{C}_4\text{H}_7\text{N}_2\text{O}_2)_2$.

By this method the nickel in a sample of steel can be determined within about two hours. The results are accurate, but lower than is often obtained in practice, because the cobalt is usually determined with the nickel, which is not the case in this method.

Removal of Ferric Chloride by Ether, Method of Rothe.

The fact that ferric chloride dissolved in hydrochloric acid, sp. gr. 1.1, is more soluble in ether than in this acid is often taken advantage of in the determination of metals such as nickel, copper, vanadium and chromium in samples of steel. It has also been used for the determination of sulphur in steel after oxidation to sulphuric acid, which does not dissolve in the ether. The underlying principle is the same as that governing the distribution of iodine between water and carbon disulphide (see pp. 658 and 659, footnote). An example will be given of such a process in the Blair method for estimating vanadium, molybdenum, chromium and nickel in steel. (See p. 313.)

METALS OF GROUP II.

MERCURY, LEAD, BISMUTH, COPPER, CADMIUM, ARSENIC, ANTIMONY, TIN (PLATINUM, GOLD, SELENIUM, TELLURIUM, MOLYBDENUM, GERMANIUM, TUNGSTEN, AND VANADIUM).

A. SULPHO-BASES.

MERCURY, LEAD, BISMUTH, COPPER, CADMIUM.

MERCURY, Hg. At. Wt. 200.6.

Forms: HgS, Hg₂Cl₂, and Hg.

Determination as Sulphide.

(a) *By Precipitation with Hydrogen Sulphide.*

The solution containing no oxidizing substances (FeCl₃, Cl, much HNO₃, etc.) and the mercury entirely as *mercuric* salt is saturated with hydrogen sulphide in the cold, the precipitate allowed to settle, filtered through a Gooch crucible, washed with cold water, dried at 105°–110° C. and weighed.

Remark.—This method affords excellent results and should be used whenever possible. Unfortunately, however, it is not always applicable, for in most cases the solution to be analyzed contains strong nitric acid (obtained by the solution of impure mercuric sulphide in aqua regia, by the decomposition of organic mercury compounds by the method of Carius, or by the oxidation of mercurous salts). It is not possible to expel the excess of nitric acid by evaporating the solution with hydrochloric acid, because considerable amounts of mercuric chloride are thereby volatilized with the escaping steam. Thus 50 c.c. of a mercuric chloride solution containing 0.5235 gm. of the salt, treated with 10 c.c. of nitric acid and evaporated on the water-bath five times almost to dryness, with the addition each time of 50 c.c. concentrated hydrochloric acid, yielded in separate experiments 0.3972 gm. mercuric sulphide = 88.56 per cent. and 0.3695 gm. mercuric sulphide = 82.39 per cent., or, in other words, a loss of 11–17 per cent. In such a case the following procedure suggested by Volhard should be used:

(b) By Precipitation with Ammonium Sulphide.

The acid solution of the mercuric salt is almost neutralized with pure sodium carbonate and is treated with a slight excess of freshly-prepared ammonium sulphide. Pure sodium hydroxide solution (free from Ag, Al₂O₃, and SiO₂) is then added, meanwhile rotating the solution until the dark liquid begins to lighten, when it is heated to boiling and more sodium hydroxide is added until the liquid is perfectly clear. The solution now contains the mercury as sulpho-salt, $\text{Hg} \begin{matrix} \text{SNa} \\ \text{SNa} \end{matrix}$. Ammonium nitrate is then added and the solution boiled until the ammonia is almost entirely expelled, and the precipitate is allowed to settle, which it will do much more quickly than if it were produced by hydrogen sulphide directly. By means of the boiling with ammonium nitrate, the sulpho-salt is decomposed according to this equation:

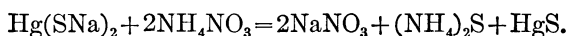

The clear liquid is poured through a Gooch crucible, and the precipitate washed by decantation with hot water until the wash water no longer reacts with silver nitrate solution. The precipitate is then transferred to the crucible, dried at 110° C., and weighed. In case the precipitate contains free sulphur, it should be boiled with a little sodium sulphite before filtering.*

H. Rauschenbach tested this method, analyzing pure mercuric chloride with the addition of nitric acid, and obtained as a mean of two experiments 73.80 per cent. Hg instead of the theoretical value, 73.85 per cent.

A still better way of removing free sulphur from the precipitate consists of extracting with carbon bisulphide. In this case the mercuric sulphide, together with the sulphur, is filtered through a Gooch crucible, completely washed with water and then three times with alcohol. The crucible is now placed upon a glass tripod in a beaker containing some carbon bisulphide (Fig. 35);†

* By boiling with sodium sulphite, the sulphur is changed to sodium thiosulphate, $\text{Na}_2\text{SO}_3 + \text{S} = \text{Na}_2\text{S}_2\text{O}_3$.

† G. Vortmann, *Uebungsbeispiele aus der quantitativen chemischen Analyse*, p. 28, Vienna, 1899.

the beaker is supported over a vessel filled with hot water and covered with a round-bottomed flask containing cold water which serves as a condenser. After about an hour the sulphur will be completely extracted. The carbon bisulphide is removed from the precipitate by washing once with alcohol and once with ether. The ether is driven off by gently warming, and the precipitate then dried at 110° C. and weighed.

H. Rauschenbach analyzed pure mercuric chloride by this method and obtained as a mean of eight experiments 73.79 per cent. Hg instead of 73.85 per cent., and in the case of eight further experiments made without removing the sulphur he obtained 74.17 per cent. instead of the theoretical value, 73.84 per cent.

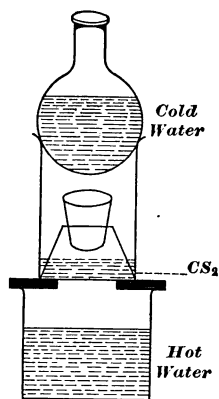

FIG. 35.

Determination of Mercury in Non-Electrolytes.

If it is desired to determine mercury in an organic non-electrolyte, the compound is decomposed by the method of Carius (see Elementary Analysis) by heating in a closed tube with concentrated nitric acid, and the mercury precipitated as sulphide by the method of Volhard; or the acid solution is treated with pure sodium hydroxide solution to alkaline reaction and then with pure potassium cyanide until the mercuric oxide has dissolved, after which the solution is saturated with hydrogen sulphide, ammonium acetate added, the solution boiled until the ammonia is almost entirely expelled, the precipitate allowed to settle, filtered, and washed first with hot water, then with hot dilute hydrochloric acid, and finally with water. After drying at 110° C. the precipitate of mercuric sulphide is weighed.

Determination as Mercurous Chloride.

For the analysis of a solution containing a mercurous salt, the solution is treated with sodium chloride, diluted considerably with water, filtered, after standing twelve hours, through a Gooch crucible, dried at 105° C., and weighed. If the solution contains a mer-

curic salt, it is first reduced, by the method of H. Rose, by means of phosphorous acid in the presence of hydrochloric acid.

Procedure.—The mercury solution (which almost always contains nitric acid) is treated with hydrochloric acid, diluted considerably with water, an excess of phosphorous acid is added, and after standing for twelve hours the precipitate is filtered through a Gooch crucible, dried at 105° C., and weighed.

Remark.—The results obtained by this method are always about 0.4 per cent. too low, but in spite of this fact the method is to be recommended.

The phosphorous acid necessary for this method is obtained by the oxidation of phosphorus in moist air or by the decomposition of phosphorus trichloride with water, evaporating the solution to remove the hydrochloric acid and dissolving the residue in water.

Determination as Metal.

Almost all mercury compounds are quantitatively decomposed on heating with lime according to the equation

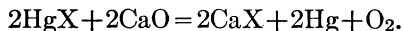

The iodide alone is not readily acted upon.

To carry out this determination, a glass tube 50 cm. long and 1.5 cm. wide, open at both ends, is taken and in one end an asbestos plug is placed, followed by 8 cm. of pure lime, then an intimate mixture of a weighed amount of substance with lime, finally a layer of lime 30 cm. long and at the other end of the tube another asbestos plug. After the tube has been filled, the end nearest this second asbestos plug is drawn out until it is only 4 cm. wide, and is connected by means of rubber tubing with the empty narrower arm of a Pélilot tube. The other wider end of the Pélilot tube is loosely filled with pure gold-leaf. The glass tube is placed in a combustion-furnace and illuminating-gas (carbon dioxide is less suited) is passed through it for half an hour. The tube is heated, at first where the 30 cm. layer of lime is, then the other burners are lighted one after another until finally the entire contents of the tube is subjected to gentle ignition. During the whole of the operation illuminating-gas is being passed through the apparatus at the rate of about three bubbles a second. The greater part of the mercury collects in the lower empty end of the Pélilot tube and

the mercury vapors that are carried further amalgamate with the gold. A small amount of the mercury condenses in the drawn-out tube. After cooling the apparatus (in a current of illuminating-gas) the narrow part of the tube is cut off both sides of the condensed mercury and weighed. It is then heated gently while air is passed through it to volatilize the mercury and again weighed. The difference in weight gives the amount of mercury condensed in the tube. The Péligré tube is usually moist; dry air is, therefore, conducted through it for some time, after which it is weighed.

The results obtained by this method * are perfectly satisfactory. Winteler found in the analysis of pure mercuric chloride 73.81, 73.88, 73.74 per cent. instead of the theoretical value, 73.85 per cent.

Experiments made attempting to condense the mercury under water invariably gave too low values (about 1-2 per cent.).

Although it is easy to obtain good results by this method, it can be dispensed with, for the sulphide method affords just as exact results in much less time.

In case it is desired to determine the amount of mercury vapor present in a given space, it is only necessary to aspirate the gas through a calcium-chloride tube filled with gold-leaf. The gain in weight of the latter shows the amount of mercury present in the gas.

Electrolytic Determination of Mercury.†

Mercury can be determined satisfactorily by the electrolysis of acid, neutral, or alkaline solutions. The metal is deposited in the form of little drops, which, when the quantity is small, adhere to the electrode, or, when larger amounts are present, the mercury may collect at the bottom of the platinum dish used as cathode. The use of silver-plated electrodes is also advised.

The electrolysis takes place to advantage in solutions slightly acid with nitric acid.

* First proposed by Erdmann and Marchand, *J. prakt. Chem.*, **31**, 385.

† Luckow, *Z. anal. Chem.*, **19**, 15 (1880); Smith and Knerr, *Am. Chem. J.*, **8**, 206; F. W. Clarke, *Ber.*, **11**, 1409 (1878); Rüderff, *Z. angew. Chem.*, **1894**, 388; Classen and Ludwig, *Ber.*, **19**, 324 (1886); G. Vortmann, *Ber.*, **24**, 2750 (1891).

Procedure.—The neutral or slightly acid solution of the mercurous or mercuric salt is placed in a beaker, diluted with water to 150 c.c., treated with 2 or 3 c.c. of concentrated nitric acid, and electrolyzed with a platinum gauze cathode at the ordinary temperature with a current of 0.055–0.10 ampere. The voltage under these conditions corresponds to 3.5–5 volts. If the electrolysis is started at night, it will be finished next morning, provided the amount of mercury does not exceed 1 gm. By using a current of 0.6–1 ampere the electrolysis is finished at the end of two or three hours. At the end of the electrolysis, the metal is washed with water without interrupting the current, then with alcohol* and dried. The metal is further dried by touching it with filter paper, and then placing it in a desiccator † over fused potassium hydroxide and a small dish of mercury. In this way correct results are obtained. Drying at 100° and then over sulphuric acid in a desiccator gives rise to low results because the acid absorbs considerable mercury vapor.

During the electrolysis of mercuric chloride ‡ the solution often becomes turbid in consequence of the formation of insoluble mercurous chloride; this does no harm, however, as the metal is subsequently deposited on the cathode.

Mercury can also be electrolyzed from a solution in potassium cyanide in the presence of some caustic alkali, and similarly from

* It is usually stated that alcohol is not to be used, but with gauze electrodes it does no harm.

† Private communication from A. Miolati, cf. Borelli, *Revista tecnica*, V, Part 7 (1905). Even at 20° the tension of mercury vapor is considerable. It amounts to 0.00133 mm.

‡ In the electrolysis of the chloride, it is better to use a platinum dish with dull, unpolished inner surface (Classen) because then any mercurous chloride will certainly be reduced to metal, which is not always the case with gauze electrodes. When a dish is used as cathode, the electrode is washed with water, without breaking the current, by pouring water into it from a wash-bottle while the solution is being siphoned off. As soon as the ammeter (or voltmeter used as an ammeter) reaches the zero mark, the washing is finished. The current is then turned off, the water carefully poured off, the rest of it removed by touching it with filter-paper, and the electrode dried as above and weighed. The drying requires several hours

a solution formed by dissolving mercuric sulphide in 50–60 c.c. of concentrated sodium sulphide solution.

The great advantage of the electrolytic determination of mercury lies in the fact that good deposits are obtained irrespective of the nature of the acid radical, or element, which is combined with mercury.

LEAD, Pb. At. Wt. 207.1.

Forms: PbO , PbSO_4 , PbO_2 , and in rare cases PbCl_2 .*

1. Determination as Lead Oxide, PbO .

If the lead is present as carbonate, nitrate, or peroxide, it is only necessary to ignite a weighed portion in a porcelain crucible over a small flame and weigh the residue. The treatment of the nitrate requires care, because on rapid ignition the mass decrepitates.

2. Determination as Lead Sulphate, PbSO_4 .

If the lead is present in solution in the form of its chloride or nitrate, it is placed in a porcelain dish, an excess of dilute sulphuric acid is added† and the mixture evaporated on the water-bath as far as possible, then over a free flame until dense white fumes of sulphuric acid are evolved, and afterwards allowed to cool. A little water is added, the mixture stirred, allowed to stand some hours, filtered through a Gooch crucible, washed at first with 4 per cent. sulphuric acid, then with alcohol, and dried at 100°C . The dried precipitate is placed in a larger porcelain crucible, provided with an asbestos ring, and ignited over the full flame of a Teclu burner.

If it is desired to use an ordinary filter, the precipitate is finally washed with alcohol until the wash liquid no longer gives the sulphuric acid reaction, dried, as much of it as possible is transferred to a weighed porcelain crucible, the filter ignited in a platinum spiral (p. 22), and the ash added to the contents of the crucible. By means of the reducing action of the burning filter, some of the lead sulphate adhering to it is always reduced to lead, which must

* See Analysis of Vanadinite.

† The solution at the time of filtering should contain about 5 per cent. of free sulphuric acid.

be changed back to sulphate before weighing. For this purpose the precipitate in the crucible is moistened with dilute nitric acid, evaporated on the water-bath to dryness, a few drops of concentrated sulphuric acid added and the crucible heated over a free flame until no more fumes are given off, when it is gently ignited and weighed.

In case the lead is originally present as acetate, the solution is treated with an excess of dilute sulphuric acid and twice its volume of alcohol, filtered after standing some hours, and the precipitate of lead sulphate treated exactly as described above.

In order to determine the amount of lead present in organic compounds, the substance can be placed in a large porcelain crucible, treated with an excess of concentrated sulphuric acid, and very cautiously heated in the covered crucible over a free flame until the sulphuric acid is completely expelled. The crucible is then gently ignited, and if the residue is white it is ready to be weighed; otherwise more sulphuric acid is added and the process repeated until finally a white residue is obtained.

In case the organic lead compound is soluble in water, it is preferable to first precipitate the lead by means of hydrogen sulphide and then transform the precipitate into sulphate. For this purpose, as much as possible of the washed and dried precipitate is placed upon a watch glass, the filter and remainder of the precipitate are heated in a large porcelain crucible, which is supported in an inclined position, and heated carefully over a small flame until the filter-paper is completely consumed. The main part of the precipitate is added to the crucible, which is then covered with a watch-glass and treated with concentrated nitric acid at the temperature of the water-bath. When the main reaction is over, the treatment with fuming nitric acid is repeated until the contents of the crucible are pure white in color. The watch-glass is then removed, five or ten drops of dilute sulphuric acid are added, the liquid is evaporated as far as possible on the water-bath, the excess of sulphuric acid is removed by heating on the air-bath (cf. Fig. 11, p. 27) and the lead sulphate is weighed. Should the precipitate be dark colored after the ignition, it is moistened with concentrated sulphuric acid and the excess of acid again expelled.

If the lead is present in an organic compound which is not capable of dissociation, the compound should be decomposed in a closed tube with strong nitric acid according to the method of Carius (see page 287), finally washing out the contents of the tube, adding sulphuric acid, and treating the precipitate as above described.

Separation of Lead Sulphate from Barium Sulphate and Silicic Acid.

In the analysis of sulphide ores containing lead, it is customary to dissolve the finely powdered ore in nitric acid, or aqua regia, and to remove the volatile acids by evaporation with sulphuric acid, eventually heating over the free flame until fumes of sulphuric acid come off thickly. The sulphuric acid should be diluted with an equal volume of water before adding it to the original solution; usually 5 c.c. of the diluted acid is sufficient. After the evaporation the moist residue is allowed to cool, then water is added and the precipitate filtered and washed with 1 per cent sulphuric acid. The precipitate contains all the lead as sulphate but often contains silica and barium sulphate (also strontium sulphate and sometimes calcium sulphate). It is purified by redissolving the lead in hot ammonium acetate solution (made by neutralizing acetic acid, sp. gr. 1.04, with ammonia, sp. gr. 0.96, and leaving the mixture barely ammoniacal). When the precipitate is large in amount it is best to wash it into a beaker or flask and heat it with about 20 c.c. of the ammonium acetate solution (or enough to dissolve all the lead sulphate), then filter through the original filter and wash with hot ammonium acetate solution, and finally with hot water until the filtrate gives no blackening with ammonium sulphide. Small amounts of lead sulphate are dissolved on the filter. The silica and barium sulphate will all remain behind.

In order to obtain lead from the acetate solution, it is precipitated as sulphide by hydrogen sulphide, and transformed, after drying, into sulphate as described on page 175.

Or, the ammonium acetate solution may be treated with 10 c.c. of 50 per cent. sulphuric acid, the acetic acid removed by evaporation, the residue allowed to cool, diluted with water, and the

lead sulphate filtered into a Gooch crucible, washed with dilute sulphuric acid, heated in an air bath and weighed.

If the amount of ammonium acetate solution used is not too large, the lead may be precipitated by adding enough sulphuric acid to the acetate solution to make the solution contain from 5–10 per cent. sulphuric acid. Sometimes the precipitate is not pure lead sulphate, in which case it should be redissolved in ammonium acetate and the precipitation as sulphate repeated.

3. Electrolytic Determination of Lead as Peroxide (PbO_2).

Many neutral solutions of complex lead salts, a neutral solution of lead acetate, also alkaline lead solutions yield deposits of metallic lead on the cathode when subjected to electrolysis; but lead is never determined this way; partly because of the round-about process necessary, and partly on account of the fact that the deposited lead is oxidized so readily. If a neutral or slightly acid (nitric acid) solution of lead nitrate is electrolyzed, the lead is deposited partly as metal upon the cathode and partly as brown peroxide on the anode. If, however, the solution contains sufficient free nitric acid, it is easily possible to deposit the lead quantitatively upon the anode as firmly-adhering lead peroxide.

Procedure.—The solution of lead nitrate, containing not more than 0.5 gm. lead, is placed in a platinum dish whose inner surface is unpolished (as recommended by Classen), 20–30 c.c. of pure nitric acid, sp. gr. 1.4, are added, the solution is diluted to 150–200 c.c. and electrolyzed in the cold with a weak current of about 0.5–1 ampere and 2–2.5 volts. When the electrolysis is carried out in the cold, all the lead will be deposited as the peroxide at the end of two hours and a half or three hours. Only an hour or an hour and a half is required if the temperature of the cell is kept at 50°–60°. If it is desired to let the electrolysis run over night, a current of 0.05 ampere is sufficient.

A suitable arrangement of the electrolytic apparatus is shown in Fig. 36, but the dish should serve as anode and the platinum spiral as cathode. The resistance W is made by taking about 10 m. of nickel wire of about 0.5 mm. diameter, fastening it to a board as shown in the drawing and connecting the wires in pairs by means of a brass hook, of which only one is shown in the sketch. By suitably moving these hooks it is possible to vary

the resistance at will. Instead of this arrangement, that shown in Fig. 31, p. 132, may be used; such an apparatus is more convenient but also more expensive. At the end of the electrolysis, which is shown by the fact that dilution with a little water so as to expose a fresh surface of platinum causes no yellowish-brown coating to appear at the end of half an hour, the dish is washed without breaking the current. This is accomplished by introducing distilled water while the solution is being siphoned off. It is important in this operation to keep the deposit

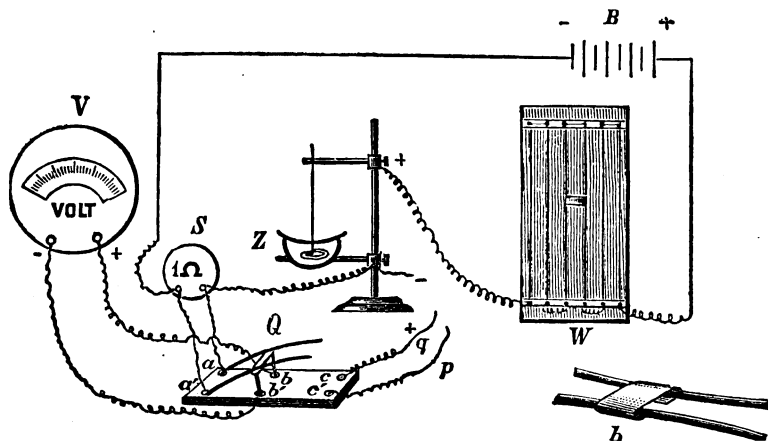

FIG. 36.

of lead peroxide completely covered with liquid. When the solution that is being siphoned off no longer reacts acid, or at least only barely acid, the washing is complete and the circuit can be broken. The dish is finally washed once more with distilled water, dried at 180° C., and weighed. The results obtained are always slightly high on account of the lead peroxide not being completely anhydrous when dried at this temperature, so that it seems to the author to be advisable to gently ignite the dish before weighing, thereby readily converting the peroxide into lead oxide.* The results obtained in the author's laboratory leave nothing to be desired.

* Cf. W. C. May, *Z. analyt. Chem.*, 14, 347 (1875).

Results.—(a) 10 c.c. lead nitrate solution containing 0.0631 gm. lead yielded deposits of PbO_2 weighing 0.0734, 0.0731, 0.0735, 0.0733 gm.; mean 0.07332 corresponding to 0.0635 gm. lead. After ignition the lead monoxide formed weighed respectively 0.0679, 0.0678, 0.0679, 0.0681; mean 0.0679 gm. corresponding to 0.0630 instead of 0.0631 gm. lead.

(b) 10 c.c. of a lead nitrate solution containing 0.1898 gm. lead yielded deposits of PbO_2 weighing 0.2202, 0.2200, 0.2203, 0.2202; mean 0.2202 corresponding to 0.1907 gm. lead. After ignition the weights of lead oxide obtained were 0.2042, 0.2046, 0.2043, 0.2044; mean 0.2044, corresponding to 0.1897 gm. Pb instead of 0.1898 gm. These experiments were performed by M. Stoffel.

Remark.—By employing a stronger current and keeping the solution warm during the electrolysis, the deposition is complete in much less time, but according to the author's experience the results obtained are not so satisfactory. By rotating one of the electrodes and using a stronger current, the deposition can be made to take place in a short time. If a little lead deposits on the cathode, this is remedied by stopping the current for a short time, toward the end of the electrolysis.

Besides the above-mentioned forms, lead is also determined as the chromate and as the chloride. The latter method is sometimes used in the analysis of bearing metal, cf. p. 252.

BISMUTH, Bi. At. Wt. 208.0.

Forms: Bi_2O_3 , Bi_2S_3 , Bi.

1. Determination as Bismuth Oxide, Bi_2O_3 .

Solid bismuth nitrate or carbonate is readily changed to the oxide by gentle ignition. When bismuth, however, is present *in solution* as the nitrate, it should be first precipitated as the basic carbonate and this changed by ignition to the oxide.

Procedure.—The solution is diluted with water (if a turbidity ensues it makes no difference) a slight excess of ammonium carbonate is added, and after heating to boiling the precipitate

is filtered off, washed with hot water, dried, ignited,* and weighed as Bi_2O_3 . If the solution from which the bismuth is to be precipitated contains besides nitric acid other acids (HCl , H_2SO_4 , etc.), the precipitate produced by ammonium carbonate always contains basic salts of these acids which cannot be converted to the oxide by ignition. In this case, which is most frequent in analysis, the bismuth should be determined according to one of the following methods.

2. Determination as Sulphide, Bi_2S_3 .

The slightly acid solution is saturated with hydrogen sulphide, filtered through a Gooch crucible (or a filter that has been dried at 100°C . and weighed), washed with hydrogen sulphide water, then with alcohol to remove the water, and afterwards with freshly-distilled carbon bisulphide † to remove any sulphur that may be mixed with the precipitate.

The washing with carbon bisulphide is continued until a few drops of the filtrate leave no residue on being evaporated to dryness on a watch-glass. The precipitate is then washed with alcohol to remove the carbon bisulphide and finally with ether, dried at 100°C ., and weighed as Bi_2S_3 .

The distillation of the carbon bisulphide should be performed as follows: Ordinary commercial carbon bisulphide is placed in a long-necked, round-bottomed flask, provided with a closely fitting cork (not rubber) stopper which is bored once. Through the hole in the cork is placed a glass tube bent twice at right angles, whose further end leads into a dry flask (without using a stopper for this receiver). Two large beakers are placed upon the table, one filled with water at about $60\text{--}70^\circ\text{C}$. and the other with cold water. If the flask containing the carbon bisulphide is placed in the beaker containing the warm water, and the other flask in the beaker of cold water, the carbon bisulphide will distil rapidly from one flask to the other. Care must be taken during this operation

* If the precipitate is large in amount, the greater part is placed on a watch-glass, the remainder adhering to the filter is dissolved in hot, dilute nitric acid, the solution evaporated to dryness in a weighed platinum dish, and the main portion of the precipitate added. The dish and its contents are heated at first gently but finally over the full flame of a Bunsen burner.

† As described on p. 169 or on p. 223.

that there is no lighted gas-burner in the immediate vicinity, for otherwise there is danger of the vapors of carbon bisulphide taking fire.

3. Determination as Metal. Method of H. Rose.*

The bismuth is first precipitated as basic carbonate as described under 1, and the dried precipitate, together with the ash of the filter, is placed in a porcelain crucible and ignited gently. Five times as much of 98 per cent. potassium cyanide is added to the contents of the crucible and the mixture is fused, whereby the oxide and basic salt are changed to metallic bismuth:

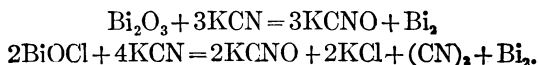

Since bismuth melts at 268° C., but boils at 1600° C., it is possible to perform this operation with a Bunsen flame of about half the usual height without running any risk of losing some of the bismuth by volatilization. The reduction is usually complete at the end of twenty minutes. After cooling, the melt is treated with water, which dissolves the salts and leaves the metallic bismuth behind in the form of a fused metallic globule. Frequently, however, the fusion will have loosened some of the glaze of the porcelain crucible, which will remain behind with the bismuth after the treatment with water. Consequently the aqueous solution is filtered through a filter that has been dried at 100° C. and weighed with the empty crucible. After washing first with water, then with absolute alcohol and ether and drying at 100° C., the filter is again placed in the crucible and weighed. The gain in weight represents the amount of metallic bismuth.

Bismuth sulphide can also be reduced by potassium cyanide, but in this case a longer and stronger heating is necessary.

4. Determination as Metal. Method of Vanino and Treubert.†

In this method the bismuth is precipitated as metal by means of formaldehyde in alkaline solution. The slightly acid bismuth solu-

* Pogg. Ann., 113, p. 425.

† Berichte. 31 (1898), 1303.

tion is treated with formaldehyde and a considerable excess of pure 10 per cent. caustic soda solution and warmed on the water-bath until the liquid above the precipitate has become perfectly clear; more formaldehyde and caustic soda solution are then added and the mixture heated over a free flame,* decanted repeatedly with water to which a little aldehyde has been added, again boiled, and by pressing with a glass rod the partly spongy, partly pulverulent precipitate is made to collect together. The precipitate is then filtered through a filter that has been previously dried at 105° C. and weighed, washed with absolute alcohol, dried at 105° C. and weighed.

Remark.—Results obtained in the author's laboratory by this method were as a rule too high. Thus W. Urech obtained from pure bismuth nitrate solution, as a mean of four experiments, 100.78 per cent. instead of 100 per cent.

The high results are caused by the difficulty in removing the last traces of alkali. Absolutely accurate results may be obtained by dissolving the precipitated bismuth in nitric acid, precipitating by ammonia and ammonium carbonate and weighing as the oxide according to (1). Naturally this roundabout process would only be chosen when the bismuth solution contained other acids (HCl, H₂SO₄, or H₃PO₄); the necessity of fusing with potassium cyanide would then be avoided.

COPPER, Cu. At. Wt. 63.57.

Forms: CuO, Cu₂S, Cu, Cu₂(CNS)₂.

1. Determination as Copper Oxide, CuO.

The solution, which must be free from organic substances and ammonium salts, is heated to boiling in a porcelain dish and pure caustic potash solution is added, drop by drop, until the precipitate becomes dark brown and is permanent, while the solution itself shows an alkaline reaction towards litmus-paper. After the precipitate has settled, the upper liquid is carefully poured through a filter and the precipitate washed by decantation with hot water until the wash water no longer shows an alkaline reaction, when the

* Frequently, particularly on long boiling, the liquid becomes colored yellow or brown. This has no influence upon the results.

precipitate is transferred to the filter and completely washed. Usually a small amount of copper oxide adheres to the porcelain dish so firmly that it can be removed only by vigorous rubbing with a glass rod covered at the end with a piece of rubber tubing, and finally when the precipitate is removed from the dish some will then remain on the rubber. Consequently it is better to proceed as follows: As much of the precipitate as possible is removed by a stream of water from the wash-bottle, then two drops of dilute nitric acid are added, and by inclining the dish and rubbing with the glass rod, the whole of the precipitate remaining on the dish is moistened with the acid. Two drops of the acid are sufficient, with correct manipulation, to dissolve all of the copper oxide. A small fresh filter is prepared and the dish is held in an inclined position, so that the liquid remains near its lip, the sides are washed once with hot water and the contents of the dish (which is continually maintained in this inclined position) are heated to boiling over a small flame and precipitated by the addition of caustic potash, drop by drop. (A large excess of alkali is to be avoided on account of its solvent action upon the precipitate.)* The whole contents of the dish are then quickly poured through the small filter and the dish is immediately washed once with water. The copper oxide is now all on the filter. The precipitate is washed with hot water, both filters are dried, and the most of the precipitate transferred to a porcelain crucible, the filters ignited in a platinum spiral, and the ash added to the contents of the crucible. The crucible is covered and ignited, at first gently, and finally with the full heat of the Bunsen burner, then weighed. If the process is carried out carefully, the results obtained are almost the theoretical values but as a rule they are a trifle high.

2. Determination as Cuprous Sulphide, Cu_2S .

The solution, which contains for every 100 c.c. about 5 c.c. of concentrated acid (best sulphuric acid), is heated to boiling and hydrogen sulphide is introduced until the solution becomes cold. If the right amount of acid was present, the precipitate settles quickly in large flocks and the upper liquid appears completely

* Cf. Vol. I.

colorless. Before filtering, the wash liquid is prepared by passing hydrogen sulphide through the long tube of a wash-bottle for one minute, then closing the short tube with a piece of rubber tubing and shaking vigorously. As soon as no more bubbles pass through the liquid, the water is saturated; this takes about a minute at the most.

A filter is now placed in a funnel containing a platinum cone, the funnel is fitted to a suction-bottle and the filtration is begun at first without using suction, taking care that the filter is constantly kept full. When all the precipitate is on the filter, it is washed with the hydrogen sulphide water containing acetic acid, and, at this point also, the filter must be kept full of liquid. The washing is continued until 1 c.c. of the filtrate shows no test for mineral acid.* The filter is now for the first time allowed to drain completely, and it is dried as much as possible by means of gentle suction, then completely by heating in the drying closet at 90°–100° C.

As much of the precipitate as possible is now transferred to a weighed Rose crucible (of unglazed porcelain),† the filter is burned in a platinum spiral and the ash allowed to fall at first upon an unglazed crucible cover, where it is heated gently till it glows, in order to make sure that it contains no unburned carbonaceous matter; the ash is then added to the main portion of the precipitate in the crucible. A little sulphur that has been recrystallized from carbon bisulphide is added to the contents of the crucible, the perforated cover is now placed on the crucible (Fig. 37), a stream of hydrogen is passed through it (the wash-bottle shown contains concentrated sulphuric acid‡), and the crucible is heated at first over a small flame and finally so that the

* The test for sulphuric acid is made with barium chloride. To test for hydrochloric acid, the solution is boiled until the hydrogen sulphide is expelled and is then treated with silver nitrate.

† A quartz crucible is more desirable, as the transformation of CuS into Cu_2S can then be watched.

‡ If the hydrogen is prepared from zinc and hydrochloric acid, the gas should be passed first through water and then through a wash-bottle containing concentrated sulphuric acid.

bottom of the crucible glows faintly, at which temperature the cupric sulphide is changed to cuprous sulphide,

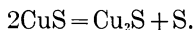

Too strong heating is inadvisable according to Hampe.*

When the excess of sulphur has been driven off (which can be readily ascertained by removing the cover of the crucible and

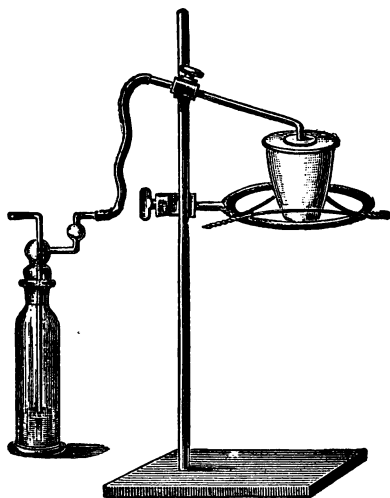

FIG. 37.

finding no blue flame to be perceptible and no odor of burning sulphur), the current of hydrogen is increased so that eight bubbles per second pass through the wash-bottle (at first, not more than four bubbles per second should have been the rate), and the flame is removed. The crucible is allowed to cool in the current of hydrogen and weighed after remaining in the desiccator for fifteen minutes. The cuprous sulphide should be brownish black or black, and should show no reddish-brown stains (due to Cu or Cu_2O); this is the case if the current of hydrogen was too slow during the cooling. In this case

† Z. anal. Chem., 38, 465 (1894).

a little sulphur must be added to the precipitate and the process repeated.

Remark.—It is evident that the sulphur used for this experiment should leave on ignition no weighable residue. This is why the sulphur used should be recrystallized from carbon bisulphide.

The reason why it is necessary to keep the funnel filled with liquid during the filtration and washing of the cupric sulphide is this: If moist copper sulphide is exposed to the air it is quickly oxidized and the hydrogen sulphide wash water acts upon the salt formed by the oxidation, ($\text{CuS}_2\text{O}_3 \cdot \text{CuSO}_4$), and transforms it into colloidal cupric sulphide, which forms a pseudo-solution, passes through the filter, and on coming in contact with the acid filtrate is coagulated. If, however, the precipitate is not exposed to the air during the filtration there is no oxidation and the filtrate remains clear.

Instead of changing the cupric sulphide into cuprous sulphide, it has been proposed to convert it to oxide by ignition in the air and weighing the copper in this form. If, however, the highest degree of accuracy is desired, this should not be done, for the ignited product always contains some sulphate. When this method is chosen, the cupric sulphide should be heated in a glazed porcelain crucible, at first over a small flame, so that the mass does not melt, and the heat gradually increased until finally a blast-lamp is used and the copper weighed as CuO . The results are about 0.1 per cent. too high when not more than 0.2 gm. of precipitate is present. Holthof* states that copper oxide absolutely free from sulphate can be obtained if the precipitate is ignited wet in an inclined porcelain crucible.

3. Determination as Cuprous Sulphocyanate, $\text{Cu}_2(\text{CNS})_2$.

Method of Rivot.†

The solution, slightly acid with sulphuric or hydrochloric acid (oxidizing agents must not be present), is treated with an excess of sulphurous acid,‡ after which ammonium sulphocyanate is

* Z. anal. Chem., 28, 680 (1889).

† Compt. Rend., 38, 868; see also R. G. van Name, Zeit. f. anorg. Chem., 26, 230, and Busse, Zeit. f. anal. Chem., 17, 53, and 30, 122.

‡ Instead of sulphurous acid, ammonium bisulphite may be used. The latter is prepared by saturating aqueous ammonia with SO_2 .

added drop by drop with constant stirring, whereby at first a greenish precipitate of cupric and cuprous sulphocyanate is precipitated, which after stirring becomes pure white. The precipitate is allowed to settle completely (this requires several hours); it is then filtered and washed with cold water until the filtrate shows only a slight reddish coloration when ferric chloride is added, after which it is washed several times with 20 per cent. alcohol, dried at 110–120° C., and weighed. R. Philipp found by this method 99.95 per cent. instead of 100 per cent. copper, as a mean of twelve experiments. The cuprous sulphocyanate can be dried at a temperature as high as 160° C., but at 180° C. it begins to decompose. The Munroe crucible can be used to advantage in this determination. The precipitate permits rapid filtration, and a turbid filtrate is never obtained. After the determination is finished, the greater part of the precipitate is shaken out of the crucible, and the remainder dissolved in hot nitric acid.

4. Electrolytic Determination of Copper.

This most accurate and most convenient of all methods for the determination of copper was first proposed by W. Gibbs in 1864.*

Copper may be deposited by means of the electric current from acid, alkaline, and neutral solutions, but for analytical purposes only the use of acid solutions is of importance.

Procedure.—The safest way, according to F. Förster,* is to deposit the copper from a sulphuric acid solution. To the neutral solution containing the copper in the form of sulphate, 10 c.c. of twice normal sulphuric acid are added, the solution is diluted to a volume of 100 c.c. and electrolyzed with exactly two volts potential at the electrodes and this potential is kept constant during the electrolysis. These conditions are fulfilled by simply connecting the electrodes with the poles of a single storage cell. The electrolysis requires at least eight hours if done at the ordinary temperature, but by keeping the solution at 70°–80°, 0.2 gm. of copper is deposited in 60–80 minutes. If, therefore, it

* Z. anal. Chem., 3, 334.

is desired to carry on the electrolysis over night, it is done in the cold. It is very easy to decide when the electrolysis is finished by adding a little water and noticing whether there is any more copper deposited upon the freshly exposed electrode surface. The cathode is then washed with water, without breaking the circuit, exactly as was described under the electrolytic determination of nickel (p. 136). Finally, the cathode is rinsed with alcohol, dried by holding it high above a flame, cooled in a desiccator, and weighed.

If these directions are followed closely, the copper is never deposited in a spongy condition. The presence of Ni, Co, Fe, Zn and Cd does not influence the analysis and the copper may be separated from these elements by means of such an electrolysis.

If the solution to be analyzed contains copper and some of the above-mentioned base metals, it is evaporated to dryness, heated with a little sulphuric acid until dense fumes are evolved, cooled, treated with 10 c.c. of 2 N. sulphuric acid, diluted to 100 c.c. and electrolyzed as described above.

If, however, only copper is present in the solution, it may be deposited very nicely in the following manner. The solution should contain 4–5 c.c. of concentrated nitric acid in 100 c.c. If, originally, it contained more nitric acid than this, it is either evaporated to dryness or neutralized with ammonia, and then the required quantity of nitric acid added. The solution is heated to 50°–60° and electrolyzed with a current of 1 ampere and electrode potential of 2–2.5 volts. The electrolysis is over at the end of two hours, when not more than 0.3 gm. of copper is present. The analysis is finished as above but there is more danger of traces of copper being dissolved while the electrodes are being removed.

Remark.—The copper may be deposited electrolytically much more rapidly by the use of a rotating electrode or any stirring arrangement. The use of a gauze cathode has also been recommended. The solution should not be diluted too much, as spongy deposits are obtained from very dilute solutions unless a very weak current is used. As a general rule, the more concentrated the copper solution, the stronger the current that can be used.

CADMIUM, Cd. At. Wt. 112.4.Forms: Cd, CdSO₄, CdO.**I. Electrolytic Determination of Cadmium.**

Of all the methods for the determination of cadmium the electrolytic method is not only the most convenient, but by far the most accurate, and of the many methods proposed that of Beilstein and Jawein* can be recommended. From the experience obtained in the author's laboratory the best procedure is as follows: To the solution of the sulphate a drop of phenolphthalein is added and then pure caustic soda solution until a permanent red color is obtained. A solution of 98 per cent. potassium cyanide is now added with constant stirring until the precipitate of cadmium hydroxide produced by the caustic soda has completely dissolved (an excess of potassium cyanide should be scrupulously avoided), the solution is diluted with water to 100–150 c.c. and electrolyzed in the cold, using a gauze cathode, for from five to six hours with a current of 0.5–0.7 ampere and an electromotive force of 4.8–5 volts; at the end of this time the current is increased to from 1–1.2 amperes and the solution is electrolyzed for one hour more. If these directions are followed, all of the cadmium (if not more than 0.5 gm. is present) will be deposited as a firmly adhering dull deposit of almost silver-white metal. The current is then stopped, the liquid is quickly poured off and the deposited metal washed first with water, then with alcohol and finally with ether; it is dried and weighed. Experiments performed by von Girsawald gave faultless results.

After the electrolysis is finished, the solution should always be tested for cadmium. For this purpose, it is saturated with hydrogen sulphide. If much cadmium is present, a yellow precipitate is obtained, but if very little, a yellow coloration results. The latter is due to the formation of colloidal cadmium sulphide, and the color is so intense that R. Philip estimates the quantity of cadmium not precipitated, by comparing the shade with that produced in a solution containing a known quantity of cadmium and the same amounts of potassium cyanide and caustic potash as in the solution tested.

* Berichte, 12, 446.

Remark.—If for the electrolysis a current of 0.5 ampere were used, the cadmium will not be all deposited at the end of twelve hours; if, however, the current is increased at the end, as above stated, to 1 ampere, the electrolysis will be surely finished at six to seven hours. To work with the stronger current from the beginning is not to be recommended unless a gauze cathode is used, or one of the electrodes is rotated, for otherwise the metal is deposited in a spongy form and on washing some of it is likely to be lost.

A solution containing 0.4568 gm. Cd., 3 gm. KCN, 1 gm. NaOH, and diluted to 125 c.c. with water, can be electrolyzed in fifteen minutes with a current of 5 amperes and 5.5 volts if one of the electrodes be rotated.*

From neutral and weakly acid solutions, cadmium can be deposited electrolytically, but not from strongly acid solutions.

2. Determination as Cadmium Sulphate, CdSO₄.

Next to the electrolytic method, the determination of cadmium as the sulphate is the best. If the cadmium is combined with a volatile acid, the compound is treated in a weighed porcelain crucible with a slight excess of dilute sulphuric acid, the solution evaporated on the water-bath as far as possible, and finally the excess of sulphuric acid is removed by heating in an air-bath (the crucible is placed in a larger crucible that is provided with an asbestos ring).† The heat is applied at first slowly, and the temperature is raised gradually until finally no more fumes of sulphuric acid are evolved. The outer crucible can even be heated with the full flame of a Teclu burner without running any risk of decomposing the cadmium sulphate; it is, however, not necessary to heat it so strongly. As soon as the fumes of sulphuric acid cease to come off, the operation is ended and the crucible and its contents are weighed after cooling in a desiccator. The cadmium sulphate should be pure white and should dissolve in water to form an absolutely clear solution.

If the cadmium has been precipitated from a solution as the sulphide, the greater part of the precipitate is placed in a large porcelain crucible, covered with a watch-glass, and treated with hydrochloric acid (1:3) on the water-bath. After the precipitate

* See Edgar F. Smith's *Electro-Analysis*.

† Cf. Fig. 11, p. 27.

has dissolved and the evolution of hydrogen sulphide has ceased, the lower side of the watch-glass is washed, the crucible is placed under the funnel, and the precipitate which adhered to the filter-paper is dissolved by dropping hot hydrochloric acid (1:3) upon it, finally washing the filter with hot water, evaporating the solution upon the water-bath, and proceeding as above described.

The results obtained by this method are excellent.

The Precipitation of Cadmium as Sulphide.

The frequently recommended determination of cadmium as the sulphide must be rejected; it is useless. It is not possible to precipitate pure cadmium sulphide from acid solutions by means of hydrogen sulphide; the precipitate is always contaminated with a basic salt ($\text{Cd}_2\text{Cl}_2\text{S}$ — $\text{Cd}_2\text{SO}_4\text{S}$, etc.) whether the precipitation takes place in cold or hot solutions, whether under atmospheric pressure or under increased pressure (in a pressure-flask), and in fact the amount of basic salt formed increases with the amount of free acid present. Results are obtained as much as 5 per cent. too high. Follenius* attempted to make the method possible by igniting an aliquot part of the dried and weighed precipitate in a stream of hydrogen sulphide. If the sulphide was contaminated with sulphate, he succeeded in changing it all to sulphide and obtained results that were acceptable. If, however, chloride was present, a considerable part was lost by sublimation, so that the results obtained were too low. It is, furthermore, not possible to ignite the cadmium sulphide with sulphur in a current of hydrogen, as was described under Zinc and Copper, for cadmium sulphide is so volatile that some of it is lost.

On the other hand, the method of precipitating the cadmium as sulphide from solutions containing 2 c.c. of concentrated sulphuric acid in 100 c.c. is to be recommended, for by this means a precipitate is obtained which can be readily filtered and which by solution in hot hydrochloric acid (1:1) and evaporation with sulphuric acid can be changed without loss to the sulphate and weighed as such.

* *Zeit. f. anal. Chem.*, XIII, 422.

3. Determination as Cadmium Oxide, CdO.

Cadmium carbonate and cadmium nitrate can be changed to the oxide by strong ignition.

The cadmium is precipitated from its solutions at the boiling temperature by the addition of a slight excess of potassium carbonate, and after standing for some time on the water-bath, and when the precipitate has completely settled, it is filtered off, washed with hot water, and dried. As much of the dried precipitate as possible is transferred to a watch-glass and set aside for the time being. The filter is washed with dilute nitric acid to dissolve the small amount of the precipitate which still adheres to it and the solution is received in a weighed porcelain crucible and evaporated to dryness. The main portion of the precipitate is now added, and the crucible is at first very gently heated by placing the open crucible high above a small flame from a Teclu burner, until the whole mass has become a uniform brown throughout. The temperature is now gradually raised until finally the full heat of the burner is reached. It is important during this operation to take care that the inner flame-mantle does not touch the crucible, for otherwise reducing gases may enter the crucible and reduce a part of the oxide to metallic cadmium, which is volatile at this temperature.* The cadmium oxide is obtained as a brown powder which is infusible, insoluble in water, but readily soluble in dilute acids.†

Remark.—It is not advisable to precipitate the cadmium by means of sodium carbonate solution, for in that case it is difficult to wash the precipitate free from alkali.

SEPARATION OF THE SULPHO-BASES FROM THE METALS OF THE PRECEDING GROUPS.

Hydrogen sulphide precipitates only the metals of the "hydrogen sulphide group" from acid solutions. It is to be noted that zinc precipitates with this group if the solution is not acid enough;

* If the cadmium carbonate is filtered into a Munroe crucible, and ignited in an electric oven, the transformation takes place readily without danger of any volatilization.

† The oxide after ignition is a black, crystalline powder.

while if the solution is too acid lead and cadmium are often incompletely precipitated. A suitable concentration is 5-7 c.c. of concentrated hydrochloric acid to 100 c.c. of liquid.

EXAMPLE.

Analysis of Brass (Alloy of Copper and Zinc with Small Amounts of Lead, Iron, and Nickel).

About 0.4-0.5 gm. of the alloy, in the form of borings,* is dissolved in about 20 c.c. of nitric acid, sp. gr. 1.2, in a 200-c.c. casserole which is covered with a watch-glass. After the reaction begins to slacken, complete solution is effected by warming on the water-bath. The solution is then evaporated to complete dryness, moistened with a little nitric acid, dissolved in about 50 c.c. of hot water, and any metastannic acid present is allowed to settle, is filtered off, washed with hot water, dried, and the tin determined according to p. 228. To the cold filtrate 3 c.c. of pure, concentrated sulphuric acid are added, the solution is evaporated on the water-bath as far as possible, and then heated cautiously over a free flame until dense white fumes of sulphuric acid are evolved. After cooling the residue is treated with 50 c.c. of water and 15 c.c. of alcohol, stirred well, filtered, washed, and the lead sulphate determined according to p. 174. The filtrate is evaporated until the alcohol is completely removed, 100 c.c. of water are added, the solution is heated to boiling, and hydrogen sulphide is conducted into it until it becomes cold, when the copper sulphide is filtered off, washed first with hydrogen sulphide water containing in every 100 c.c. 20 c.c. of double-normal sulphuric acid and at the end with 5 per cent. acetic acid, which is saturated with hydrogen sulphide, until the filtrate gives no precipitate on being treated with barium chloride. The copper is determined, according to p. 183, as Cu_2S .

The filtrate from the copper sulphide is evaporated to a small volume in order to remove completely the excess of hydrogen

* The borings are usually somewhat greasy. They should be washed with ether before weighing. Cf. p. 236, foot-note.

sulphide, the iron is then oxidized by the addition of bromine water, precipitated by ammonia, and filtered. In order to make sure that the precipitate of ferric hydroxide contains no zinc, it is dissolved in a little hydrochloric acid and the precipitation with ammonia is repeated. The filtered and washed precipitate is ignited in a porcelain crucible and weighed as ferric oxide (cf. p. 87).

The combined filtrates from the ferric hydroxide are acidified with a little sulphuric acid, heated to about 50° C., and the zinc determined as zinc sulphide according to the "salting-out" method described on p. 160. For the determination of nickel, the filtrate from the zinc sulphide precipitation is boiled to expel the hydrogen sulphide and the nickel determined as the salt of dimethyl glyoxime according to p. 129.

SEPARATION OF THE SULPHO-BASES FROM ONE ANOTHER.

I. Separation of Mercury from Lead, Bismuth, Copper, and Cadmium.

Method of Gerhard v. Rath.

Principle.—This separation is based upon the insolubility of mercuric sulphide in boiling, dilute nitric acid (sp. gr. 1.2–1.3) and the solubility of the remaining sulphides.

Procedure.—The solution (containing the mercury entirely in the mercuric form) is precipitated by means of hydrogen sulphide, the precipitate filtered off, washed with hydrogen sulphide water, transferred to a porcelain dish and boiled for a considerable length of time with nitric acid of the above concentration, then diluted with a little water and washed with water containing nitric acid. The residue of mercuric sulphide thus obtained always contains sulphur, and in case considerable lead were present it will also contain lead sulphate. It is, therefore, dissolved in a little aqua regia, diluted with water, filtered from the separated sulphur and lead sulphate and the mercury precipitated according to the method of Volhard, with ammonium sulphide (cf. p. 169). If some of the lead sulphate should go into solution with the mercury on treating

with aqua regia, it will be converted by the ammonium sulphide and potassium hydroxide into insoluble lead sulphide, while the mercury will be in the form of its soluble sulpho-salt. In this case the lead sulphide is filtered off, washed with dilute potassium hydroxide solution, and the mercury then precipitated as sulphide, as described on p. 169.

2. Separation of Bismuth from Lead.

(a) Method of Löwe.*

Principle.—Bismuth nitrate is changed by the action of water into an insoluble basic salt, while lead nitrate undergoes no such transformation.

Procedure.—The solution of the two metals in nitric acid is evaporated on the water-bath until it reaches a syrupy consistency, water is added, and after thorough stirring with a glass rod the evaporation is repeated and the process continued until the addition of the water fails to produce any further turbidity; a sign that the bismuth has been completely converted into the basic salt $\text{Bi}_2\text{O}_2\text{NO}_3\text{OH}$. A cold solution of ammonium nitrate (1 NH_4NO_3 :500 H_2O) is now added, and after standing some time, with frequent stirring, in order to make sure that the lead nitrate is completely dissolved, the solution is filtered. The precipitate is washed with the dilute ammonium nitrate solution and dried. As much of it as possible is transferred to a weighed porcelain crucible and together with the ash of the filter is ignited, † at first gently, and finally with the full flame of a Bunsen burner. It is weighed as Bi_2O_3 .

From the filtrate the lead is precipitated according to p. 174, as sulphate, and weighed as such. It is less satisfactory to precipitate the lead as sulphide and weigh it in this form after gentle heating with sulphur in a Rose crucible.

(b) Method of Jannasch.‡

Principle.—The separation depends upon the different volatility of the two bromides. Bismuth bromide is fairly readily volatile; lead bromide is only difficultly so.

* *J. pr. Chem.*, **74**, 345 (1858). Cf. Little and Cahen, *The Analyst*, **35**, 301.

† It is still better to proceed as in the determination of cadmium oxide, p. 192.

‡ *Praktischer Leitfaden der Gewichtsanalyse*.

Procedure.—The solution of the nitrates is evaporated to dryness, 100 c.c. of water, sufficient hydrochloric acid to afford a clear solution, and a few drops of fuming nitric acid are added,* after which hydrogen sulphide is introduced. The precipitated sulphides are immediately filtered, the precipitate is dried at 100° C. in a stream of carbon dioxide, after which as much of the precipitate

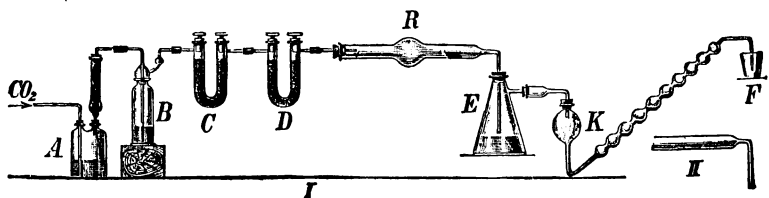

FIG. 38.

as possible is placed in an agate mortar and the ash of the filter added to it. The whole of the precipitate is ground fine and transferred without loss to a weighed porcelain boat, which is then introduced into the decomposition tube *R*† (Fig. 38), made of difficultly-fusible glass. At first a stream of dry carbon dioxide is passed through the apparatus and the substance is gently heated by means of a small flame, in order to completely dry it. The water condensing in the front part of the tube is driven over into *E* by careful heating.

The bottle *A* containing bromine ‡ is now connected with the apparatus and the stream of carbon dioxide is passed through it; the gas, carrying bromine vapors with it, is passed through the vertical calcium chloride tube filled with pieces of calcite,

* By the addition of the fuming nitric acid the precipitated sulphide is contaminated with considerable sulphur; such a precipitate is more readily decomposed by the action of bromine.

† In this determination, the bulb of the tube is unnecessary; it should be replaced by one such as is shown in Fig. 38, *II*. For other analyses it is better to have the bulb.

‡ For this experiment the bromine used must be absolutely free from chlorine and is prepared as follows: 50–60 c.c. of commercial bromine are treated, in a tightly stoppered separatory funnel, with a 10 per cent. potassium bromide solution. The funnel is shaken vigorously, and the bromine separated from the aqueous alkali solution. After washing two or three times with water it is ready for use.

then through the concentrated sulphuric acid contained in *B*, after this through the tube *C* containing glass beads moistened with sulphuric acid, and finally through the tube *D* filled with glass wool, and from this the dry bromine vapors reach the substance. The latter is heated over a small flame (kept in constant motion) and the yellow bismuth bromide distils off and condenses partly in the narrow part of the tube and partly in the receiver *E*, which contains dilute nitric acid (1 HNO_3 :2 H_2O). The substance is heated hotter, whereby more bismuth bromide is volatilized, and this is again distilled as completely as possible into the receiver. Finally the substance is heated more strongly still, until the lead bromide begins to melt. When no more of the yellow sublimate is formed, the decomposition is shown to be complete and the substance is allowed to cool in a stream of carbon dioxide. The bromine that escapes from the tube *K* is passed into alcohol contained in the beaker *F*. When the apparatus has become cold, the bromine bottle is removed, and the bromine is removed from the apparatus by passing carbon dioxide through it for some time. The boat filled with lead bromide is then weighed, and from the weight of the PbBr_2 that of the lead is computed. To check this, the lead bromide is dissolved in freshly-prepared chlorine water, an excess of dilute sulphuric acid is added, and the solution is evaporated to remove the hydrochloric acid, at first on the water-bath and finally over a free flame until dense fumes of sulphuric acid are evolved.

After cooling, water and alcohol are added, the precipitate filtered off and the weight of the lead sulphate determined as described on p. 174. For the bismuth determination, the nitric acid solution contained in *E* and *K* is poured into a beaker, filtered if necessary from any sulphur, evaporated to a small volume, and the bismuth precipitated by the addition of ammonium carbonate and determined as metal as described on p. 181.

There have been many other methods proposed for the separation of lead and bismuth,* all of which are less satisfactory than the two methods just described, so that they will not be discussed in this book.

* Cf. O. Steen, *Z. angew. Chem.*, 1895, p. 530.

3. Separation of Bismuth from Copper.

The solution is treated with an excess of ammonium carbonate, warmed gently, and filtered. The precipitate of basic bismuth carbonate almost always contains small quantities of copper, so that it is dissolved in nitric acid and the separation by means of ammonium carbonate is repeated. The basic bismuth salt is fused with potassium cyanide and weighed as metal, according to p. 181.

For the copper determination, the two filtrates are combined, evaporated to remove the excess of ammonium carbonate, acidified with sulphuric acid, and the copper precipitated by means of hydrogen sulphide, being determined as cuprous sulphide according to p. 183, or the sulphuric acid solution is subjected to electrolysis as described on p. 187.

According to Fresenius and Haidlin, bismuth can be separated from copper very nicely by means of potassium cyanide. For this purpose the acid solution is precipitated by the addition of a slight excess of sodium carbonate, potassium cyanide is added, and the solution warmed and filtered. All of the copper is found in the filtrate, while the precipitate contains bismuth oxide contaminated with alkali. The residue is, therefore, dissolved in nitric acid, the bismuth precipitated by means of ammonium carbonate and determined as metal according to p. 181. The filtrate containing the copper is evaporated with nitric acid, in order to destroy the cyanide, and the copper determined electrolytically according to p. 187.

4. Separation of Lead from Copper by Means of Electrolysis.

This separation depends upon the fact that the electric current deposits lead quantitatively as PbO_2 upon the anode from solutions containing a definite amount of nitric acid, while the copper is either not deposited at all under these conditions or is found upon the cathode to some extent. After the lead is completely deposited, the copper solution is poured into a second weighed platinum dish, the excess of the acid is neutralized with

ammonia, and the solution again electrolyzed. The copper will now deposit quantitatively upon the cathode.

Procedure.—The solution of the two nitrates is placed in a platinum dish (of the form recommended by Classen with the inner surface unpolished) and 15 c.c. of nitric acid (sp. gr. 1.35–1.38) are added, after which the solution is diluted to 150 c.c. and electrolyzed at 50°–60° C. with a current of 1–1.5 amperes and an electrode potential of 1.4 volts. After 1–1.5 hours practically all the lead will be deposited upon the anode (dish) in the form of a firmly adhering, brown coating of lead peroxide, PbO_2 . At the cathode (a plate electrode) a considerable part of the copper will be deposited, but the remainder will still be in solution. The circuit is broken and the solution poured as quickly as possible into a second weighed platinum dish, and the washings added to this dish. After washing the electrodes with water, the first dish with the PbO_2 deposit is dried at 180° and weighed. The solution in the second dish contains a little lead and some copper, it is made slightly ammoniacal, 4 c.c. of concentrated nitric acid are added, and the solution electrolyzed at 60°. The platinum dish now serves as the cathode, while the plate electrode* serves as the anode; in case traces of lead remain in solution after the first electrolysis, it will now be deposited. After an hour or two with a current of one ampere all the remaining copper and lead will be deposited. When the electrolysis is complete the electrodes are washed without breaking the circuit and the weight of the copper and PbO_2 is determined.

If only small amounts of lead and copper are present, the electrolysis should take place under the conditions described on p. 187, except in this case a weighed plate electrode should be employed as the anode. Under these conditions the lead will be deposited as the peroxide upon the anode, while the copper will separate out upon the dish.

*The plate electrode with copper upon it was weighed, cleaned, and then weighed again.

5. Separation of Lead from Copper and Cadmium.

(From Bismuth less satisfactorily.)

The solution of the nitrates or chlorides is treated with an excess of sulphuric acid, evaporated to remove the nitric or hydrochloric acid, and the lead determined as sulphate as described on p. 174.

6. Separation of Copper from Cadmium.

(a) *Method of A. W. Hofmann.**

A. W. Hofmann states that copper and cadmium can be separated from one another by boiling their sulphides with sulphuric acid (1:5) whereby cadmium sulphide is dissolved while copper sulphide is unacted upon. Hofmann seems to have tested this separation only qualitatively and not quantitatively, but nevertheless this method is given in all early text-books without submitting any analyses to prove its accuracy. Experiments performed in the author's laboratory showed that in the form proposed by Hofmann this method cannot be used for the quantitative separation of the two metals; on the other hand, if it is carried out according to the following modifications, excellent results are obtained.

Procedure.—Sufficient sulphuric acid is added to the solution of the sulphates so that one part of the acid is contained in four parts of the solution. The latter is now heated to boiling, and during the boiling hydrogen sulphide is passed through it for twenty minutes, after which the solution is boiled for fifteen minutes longer. The solution is filtered while hot through a funnel kept filled with carbon dioxide and the precipitate is washed with boiled, hot water to the disappearance of the acid reaction. The copper sulphide thus obtained is easy to filter and wash; it however, always contains small amounts of cadmium, so that the separation must be repeated. The copper sulphide is, therefore, transferred to a porcelain dish by means of a stream of water from

* Ann. d. Chem. und Pharm., 115, 283.

the wash-bottle, where it is dissolved in nitric acid, the solution evaporated to dryness, the dry mass treated with sulphuric acid (1:4) and again evaporated on the water-bath as far as possible to remove the greater part of the nitric acid. After this, without regard to the separated sulphur, the mass is washed with as little water as possible into an Erlenmeyer flask, for every 0.3–0.5 gm. of copper about 150–200 c.c. of sulphuric acid (1:4) are added, and the separation by means of hydrogen sulphide is repeated exactly as above described. The pure copper sulphide that is finally obtained is dried and the copper determined as cuprous sulphide as described on p. 183, or it is dissolved in nitric acid and the solution electrolyzed as described on p. 187.

For the cadmium determination, hydrogen sulphide is passed into the cold filtrate, the precipitated cadmium sulphide after being washed is transferred by means of a spatula to a porcelain dish, hydrochloric acid (1:3) is poured over it, the dish covered with a watch-glass and heated on the water-bath until the precipitate is dissolved and until the hydrogen sulphide is all expelled. The dish is now placed under the funnel and the cadmium sulphide which remained upon the filter is dissolved by dropping hot hydrochloric acid (1:3) upon it, finally washing the filter with water. The contents of the dish are evaporated to dryness, the dry mass dissolved in a little sulphuric acid, washed into a weighed porcelain crucible, and treated with 1 c.c. of concentrated nitric acid* and a little more sulphuric acid. After this the contents of the crucible are evaporated as far as possible upon the water-bath, the excess of sulphuric acid removed by heating in an air-bath, and the cadmium determined as sulphate according to p. 190.

The above method was tested by Oberer in the author's laboratory and the following results obtained:

* The nitric acid is added to oxidize the fibres of filter-paper; if these are not destroyed they will cause a partial reduction of the cadmium sulphate.

Amount Taken.	Found.	Difference.	Amount Found in Per Cent. of the Theoretical Value.
1. Cu=0.3126 gm. Cd=0.2504 "	0.3130 gm. 0.2506 "	+0.0004 +0.0002	100.12 100.03
2. Cu=0.3126 "	0.3125 "	-0.0001	99.97
Cd=0.2504 "	0.2501 "	-0.0003	99.88
3. Cu=0.3126 "	0.3134 "	+0.0003	100.25
Cd=0.2504 "	0.2496 "	-0.0008	99.68
4. Cu=0.3126 "	0.3120 "	-0.0006	99.81
Cd=0.6259 "	0.6252 "	-0.0007	99.88
5. Cu=0.3142 "	0.3147 "	+0.0005	100.16
Cd=0.6259 "	0.6248 "	-0.0011	99.82
6. Cu=0.3142 "	0.3150 "	+0.0008	100.25
Cd=0.6259 "	0.6240 "	-0.0019	99.69

(b) *Method of Rivot-Rose.*

The copper is precipitated as sulphocyanide according to p. 186, and from the filtrate the cadmium is precipitated as sulphide by means of hydrogen sulphide and determined as sulphate according to p. 190. The results are good.

(c) *Method of Fresenius and Haidlen.*

(The Potassium Cyanide Method.)

The neutral solution containing salts of both metals is treated with potassium cyanide until the precipitate that is first formed redissolves, after which more potassium cyanide is added (about three times as much as was necessary for the precipitation and solution of the precipitate) and either ammonium or hydrogen sulphide is added to the cold solution. The cadmium is precipitated as the yellow sulphide, while the copper remains in solution.*

*The copper, however, remains entirely in solution only when more than enough potassium cyanide is present than is required to form the complex salt $K_2Cu(CN)_4$. If the pure potassium cuprocyanide is dissolved in considerable water and hydrogen sulphide passed into the solution, there is a partial precipitation of Cu_2S ; the more dilute the solution, the more the precipitation. By the addition of an excess of potassium cyanide, the precipitation is prevented. A cold, concentrated solution of the above salt is not precipitated by hydrogen sulphide (v. Girsowald, Zurich, 1902)

The cadmium sulphide thus precipitated shows a great tendency of passing through the filter-paper even when a "hardened" filter is used, so that it is "salted out." A considerable amount of pure, solid potassium chloride is stirred into the solution, the precipitate is allowed to stand overnight, and in the morning it is filtered through a Schleicher & Schüll "hardened filter." The precipitate is washed first by decantation with concentrated potassium chloride solution, it is then transferred to the filter and washed with the same solution. For the cadmium determination this precipitate cannot be used on account of the potassium chloride which adheres to it, and it is not advisable to wash the salt out with water, for in this case a turbid filtrate will be obtained. It is, therefore, dissolved in hot hydrochloric acid (1:3) from a wash-bottle, the solution is evaporated to dryness, the residue dissolved in water, filtered if necessary from separated sulphur, and for every 100 c.c. of the solution 5-7 c.c. of concentrated sulphuric acid are added, and the cadmium is precipitated by passing hydrogen sulphide into the cold solution. This time the cadmium sulphide is easily filtered. The cadmium is determined as sulphate according to p. 190.

The filtrate is evaporated with nitric acid until the odor of hydrocyanic acid can no longer be detected, and the copper is most conveniently determined according to p. 183 as cuprous sulphide.

Remark.—The results obtained by this method are good, but considerable time and patience are required.

(d) *By Electrolysis.*

The experiments of R. Philipp in the author's laboratory show that a very accurate separation can be made, as recommended by Neumann, by electrolyzing the nitric acid solution.

The solution, containing not more than 0.2 gm. cadmium, is treated with 4-5 c.c. of concentrated nitric acid or 10 c.c. nitric acid sp.gr. 1.2, and diluted to 150 c.c. in a platinum dish. The anode, a disk electrode, is placed so that it only dips into the liquid a short way. Under these conditions, 0.2 gm. of copper is deposited perfectly free from cadmium, within 12 or 14 hours

by a current of 0.2–0.3 ampere and a voltage of 1.9–2.3 volts. with a current of 1 to 1.5 amperes and 2.5–2.6 volts electrode potential, the cadmium is deposited in about five hours. The solution is siphoned off, while pure water is poured into the dish without breaking the current; the dish is finally rinsed with alcohol, dried and weighed with the deposited copper. The solution is treated with sufficient sulphuric acid, evaporated to expel the nitric acid, cooled, diluted and the cadmium electrolyzed from cyanide solution as described on p. 189.

Remark.—If considerably more than 0.2 gm. Cd is present in 150 c.c. of the solution, there is danger of small amounts of cadmium separating out upon the copper during the washing of the deposit, especially when the anode extends well into the solution. This is because the concentration of the acid becomes less during the washing. In analyzing a solution containing a large amount of cadmium and small amount of copper, therefore, it is best to wash at first with 2 per cent. nitric acid rather than with distilled water.

The separation requires but a few minutes with a rotating anode or cathode, and a stronger current.

B. DIVISION OF THE SULPHO-ACIDS.

Arsenic, Antimony, Tin.

SELENIUM, TELLURIUM, GOLD, PLATINUM, TUNGSTEN,
MOLYBDENUM, VANADIUM.)

ARSENIC, As. At. Wt. 74.96.

Forms: As_2S_3 , As_2S_5 , $\text{Mg}_2\text{As}_2\text{O}_7$.1. Determination as Arsenic Trisulphide, As_2S_3 .

For the determination of arsenic in this form, it must be present in its trivalent state, i.e., as arsenious acid or as arsenite.

The solution is made strongly acid with hydrochloric acid and the arsenic precipitated in the cold with hydrogen sulphide. The excess of the latter is removed by passing a stream of carbon dioxide through the solution, which is then filtered through a Gooch crucible that has been previously dried at 105°C . The precipitate is washed with hot water, dried at 105°C . to constant weight, and weighed as As_2S_3 .

2. Determination as Arsenic Pentasulphide, As_2S_5 , according to Bunsen.**Modified by Fr. Neher.†*

The solution, which must contain all of the arsenic as arsenic acid, is treated with hydrochloric acid little by little (it is best to keep the solution cooled by surrounding the flask with ice) until the solution contains at least two parts of concentrated hydrochloric acid for each part of water. A very rapid stream of hydrogen sulphide is conducted into this solution (contained in a large Erlenmeyer flask) until it is saturated with the gas, after which

* Ann. d. Chem. und Pharm., 192, 305.

† Z. anal. Chem., 32, 45; see also Brunner and Tomicek, Monatshefte, 8, 607; McCay, Z. anal. Chem., 27, 682, and J. Thiele, Ann. d. Chem. u. Pharm., 265, 65.

the flask is stoppered and allowed to stand two hours. The arsenic pentasulphide is then filtered through a Gooch crucible which has been dried at 105° C., and the precipitate is washed completely with water, then with hot alcohol (to hasten the subsequent drying). After drying at 105° C. the precipitate is weighed as As_2S_5 . It is not necessary to wash it with carbon bisulphide.

Remark.—If the above directions are conscientiously followed, this method gives faultless results. If, on the other hand, the directions are deviated from in the slightest respect, the precipitate is likely to contain some arsenic trisulphide, whereby low results will be obtained. If the solution is not kept cool and the hydrochloric acid is added too rapidly, the heat of the reaction suffices to change a part of the arsenic chloride (this compound probably exists in solution) to arsenious chloride and chlorine, so that on passing hydrogen sulphide into the solution a mixture of arsenic trisulphide and arsenic pentasulphide will be obtained.

3. Determination of Arsenic as Magnesium Pyroarsenate, according to Levol.

The solution, which must contain all of the arsenic as arsenate, and have a volume of not over 100 c.c. per 0.1 gm. arsenic, is treated drop by drop, under constant stirring, with 5 c.c. of concentrated hydrochloric acid and then, for each 0.1 gm. of arsenic, there is added 7–10 c.c. of magnesia mixture* and a drop of phenolphthalein solution. Now, with constant stirring, 10 per cent. ammonia is added from a burette until the phenolphthalein imparts a permanent red color to the solution, and then enough more of the 10 per cent. ammonia is added to make one-third the volume of the neutralized solution. After standing twelve hours the liquid is filtered through a Gooch or Monroe crucible. The precipitate in the beaker is transferred to the crucible by squirting upon it some of the original solution from a small wash bottle. The precipitate is then washed with 2.5 per cent. ammonia until free from chloride. It is drained as

* Prepared by dissolving 55 gms. crystallized magnesium chloride and 70 gms. ammonium chloride in 650 c.c. water and diluting this to a volume of one liter with ammonia, sp.gr. 0.96.

completely as possible by suction, dried at 100° and heated in an electric oven quite gradually to a temperature of about 400° to 500° , until there is no more ammonia evolved. Then the temperature is raised to 800° to 900° and kept there for about 10 minutes. The crucible is then cooled in a desiccator and the precipitate weighed with the precipitate in the form of $Mg_2As_2O_7$.

If an electric oven is not available the crucible with the precipitate is placed in an air-bath (cf. Fig. 11, p. 27), having the bottom of the Gooch crucible [come within about 2–3 mm. of the bottom of the outer crucible. A thin layer of ammonium nitrate powder * is added to the precipitate, which is then heated, at first gently, gradually increasing the temperature until a light-red glow on the outer crucible is obtained, after which the precipitate is allowed to cool in a desiccator and is weighed as $Mg_2As_2O_7$. The results obtained are excellent.

Remark.—The precipitate produced by the magnesia mixture has the formula $MgNH_4AsO_4 + 6H_2O$ and loses $5\frac{1}{2}$ molecules of water at 102° C.; it has, therefore, been proposed to dry the precipitate at this temperature and to compute the amount of arsenic present as follows:

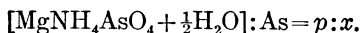

It is, however, impossible to obtain a constant weight at this temperature, so that the procedure is not to be recommended. If the precipitate is dried at 105 – 110° C. the salt is obtained almost entirely free from water and at a slightly higher temperature it begins to decompose. The only form in which the precipitate should be weighed is as magnesium pyroarsenate.

* Instead of using ammonium nitrate, the crucible may be provided with a perforated cover and heated in a current of oxygen.

Solubility of Magnesium Ammonium Arsenate, according to Level.

600 parts of water dissolve 1 part of the salt.

In $2\frac{1}{2}$ per cent. ammonia it is almost entirely insoluble. According to J. F. Virgili,* 1 part of anhydrous magnesium ammonium arsenate dissolves in 24,558 parts of ammonia water.

Colorimetric Determination of Arsenic.

Small quantities of arsenic, such as are present in wall papers, may be estimated very accurately by means of the Marsh apparatus, comparing the mirror with a series of standards formed with known quantities of arsenic.† It is just as accurate, however, to use the much simpler apparatus used for the Gutzeit test. Treadwell and Comment‡ allow the arseniuretted hydrogen to react with disks containing silver nitrate and compare the resulting color with a standard which, unfortunately, must be produced freshly with each analysis, as it does not keep very well. Almost equally accurate, and much more convenient is the method of F. Hefti§ and that of C. R. Sanger and O. F. Black|| in which the arseniuretted hydrogen is allowed to act upon mercuric chloride paper.

(a) Method of Hefti.

In the first place, all the organic matter is destroyed by heating the sample in a tube with fuming sulphuric and nitric acids (see Vol. I), both of which must be free from arsenic. The resulting liquid is evaporated with sulphurous acid on the water-bath in order to reduce the arsenic acid to arsenious acid and when all the excess of SO_2 has been expelled, the solution is poured into the graduated tube *T* of the apparatus shown in Fig. 39. In the 100–150 c.c. flask *K* are placed 6–8 gm. of

* Z. anal. Chem., 44, 504 (1905).

† C. R. Sanger, Am. Chem. J., 13, 431 (1891); Z. anal. Chem., 38, 137 and 377; G. Lockemann, Z. angew. Chem., 1905, 429 and 491.

‡ This method was given in the former editions of this book.

§ Inaug. Dissert. Zürich, 1907.

|| Proc. Amer. Acad. Arts and Sciences, No. 8, 1907.

granulated zinc coated with copper* and about 20 c.c. of sulphuric acid free from arsenic (1 vol. conc. acid + 7 vols. water). At the end of ten minutes all the air should be expelled from the apparatus. The outlet *D*† is now covered with a piece of mercuric chloride paper and kept in place by a small piece of ground glass. According to whether little or much arsenic is present, a light or a

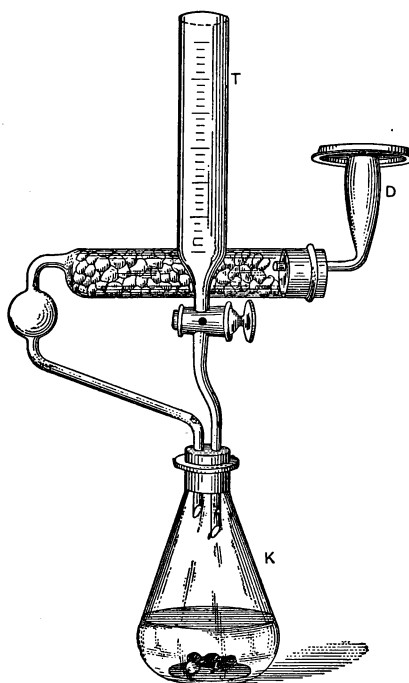

FIG. 39.

part of the solution in *T* is allowed to flow into the flask *K*. At the end of twenty minutes the experiment is finished. By comparing the color of the spot produced on the mercuric chloride

* Cf. Vol. I.

† For quantities of arsenic under 0.02 mg., the upper diameter of the tube *D* should be 8 mm. and for larger quantities it should be 16 mm. The upper edge of the tube is ground perfectly flat.

paper, with the standard spots, the quantity of arsenic present is determined.

The disks of mercuric chloride paper are prepared by dipping pieces of pure filter paper into a saturated solution of mercuric chloride and drying them in an oven at a temperature of 60°–70°.

The standards are prepared by carrying out a series of experiments with known quantities of arsenic. The spots thus obtained soon lose their color when exposed to moist air, but when dry can be kept in the dark for several days. An older standard is not reliable, but can be used to estimate the approximate quantity of arsenic and then, by making two or three standards with known quantities, the exact amount of arsenic can be determined. The standard solution of arsenious acid used in preparing the scale should contain 20 mg. of As_2O_3 in a liter. Then

$$0.05 \text{ cm.} = 0.001 \text{ mg. As}_2\text{O}_3,$$

$$0.1 \text{ c.c.} = 0.002 \quad \text{etc.}$$

For smaller amounts of arsenic the above solution is diluted with nine times as much water and thus made one-tenth as strong.

(b) Method of C. R. Sanger.

Three grams of uniformly granulated, pure zinc is placed in the 30 c.c. evolution flask (Fig. 40) which is fitted with a stopper holding a thistle tube and a gas delivery tube. The enlargement of the horizontal tube contains a wad of cotton and at the outer end is a piece of thick filter-paper which has been dipped into mercuric chloride solution and dried. Through the thistle tube is poured 15 c.c. of arsenic-free, dilute hydrochloric acid* (1:6) and the hydrogen evolution is allowed to proceed for at least ten minutes to drive out the air from the apparatus. At the end of this time, a measured, or weighed, quantity of the arsenic solution to be tested is added to the flask, which is then nearly filled with water. After a few minutes, the mercuric chloride paper begins to color and at the end of thirty minutes will attain

* When hydrochloric acid is used it is unnecessary to plate the zinc with copper.

the maximum coloration. By comparison with standards, the quantity of arsenic present is estimated.

Inasmuch as the color of the standards is strongly influenced by moisture, Sanger recommends preserving the strips in a perfectly dry condition. For this purpose a little phosphorus pentoxide is placed in a small test-tube, followed by a little cotton, and then the strip of paper is shoved in with the colored part at

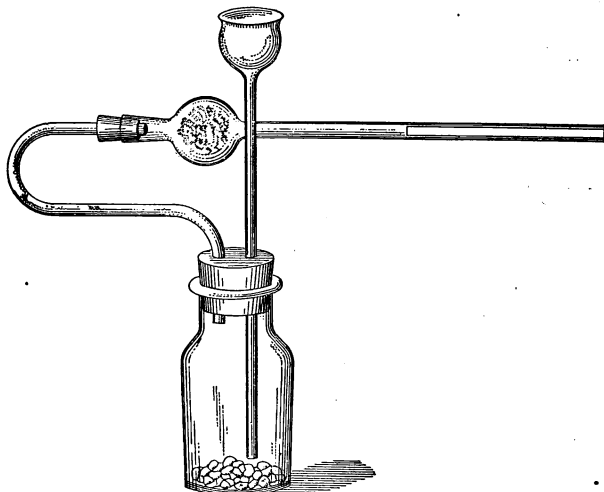

FIG. 40.

the bottom. The upper end of the paper is moistened with a drop of Canada balsam, after which the tube is closed and sealed. In this way the color can be preserved for several months, although the freshness disappears after a few weeks. See the colored chart at the end of the book, upper row.

The color holds a little better if the strips of paper, after being colored, are moistened with strong hydrochloric acid and then dried. Some 6N·HCl is placed in a small test tube, heated to at least 60°, the strips of paper dipped in the acid and allowed to remain there two minutes, washed thoroughly in running water, dried and sealed in tubes as described above. After the drying, the color is a little duller. See the colored chart, middle row.

If, however, the strips of colored paper are treated with normal ammonia solution, the spot which was originally red turns *black*. After drying, such strips are kept in small test-tubes over calcium chloride. These standards are much more permanent than when prepared as above. See the colored chart, bottom row.

Remark.—To make the strips uniform as regards the length of the spot and the color, the following conditions must be fulfilled:

1. The evolution flask must be kept the same size and the delivery tubing must be of uniform bore.
2. The same quantity of zinc of the same size must be used in all the tests.
3. The volume and concentration of the acid must remain the same.
4. The wad of cotton must not get too moist. After 10 or 12 experiments it should be renewed.
5. H_2S , SbH_3 and PH_3 must not be present, as they give a colored spot with the $HgCl_2$ paper.

(c) Electrolytic Determination of Arsenic.*

Instead of producing the arseniuretted hydrogen by means of zinc and acid, it may be formed with the aid of cathodic hydrogen. Thorpe passes the arsine through a heated tube and produces an arsenic mirror, but Hefti † allows the gas to react with mercuric chloride paper. In both cases the apparatus devised by Thorpe is used and is shown in Fig. 41.

As cathode a perforated cone of thin lead foil is used. This is suspended from the platinum wire that has been fused into the ground-glass stopper of the cathode compartment. The anode consists of platinum foil, two or three centimeters wide, which is wrapped around the porous cell.

* Cf. Bloxam., *Z. anal. Chem.*, **1**, 483 (1862); T. E. Thorpe, *Proc. Chem. Soc.*, **19**, 183 (1903); W. Thomson, *Manch. Memoirs*, **48**, No. 17 (1904); S. R. Tootmann, *Chem. Zentr.*, **1904**, I, 1295; H. J. S. Sand and E. Hackford, *Chem. Zentr.*, **1904**, II, 259.

† *Inaug. Dissert.*, Zürich, 1907.

Procedure.—Pure, dilute sulphuric acid (1:7) is poured into the earthenware cell and into the glass outer vessel, *E*; the level of the acid should be about 2 or 3 cm. from the bottom in the former, and about 0.5 cm. higher in the latter. For the colorimetric determination, the arsenic solution is poured directly into the acid of the inner cell. It must be present as arsenious acid, and, if this is not the case, it must be reduced with sulphurous acid and the excess of the latter expelled by heating. For the

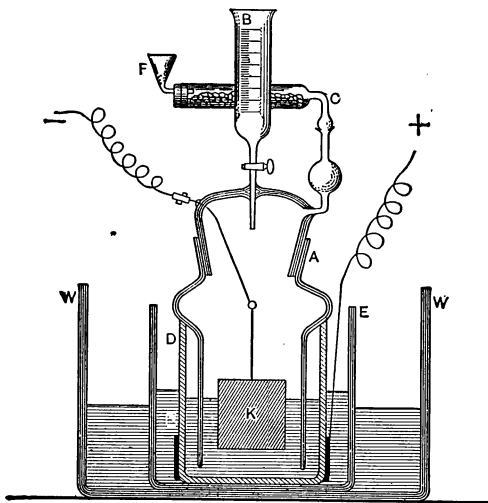

FIG. 41.

production of mirrors, the air must all be expelled by hydrogen before the arsenic solution is added. The tube *C* is filled with crystallized calcium chloride. The outlet at *D* is covered with a disk of mercuric chloride paper (see Method *a*) and then the circuit is closed. The potential should be about 7 volts and the current about 2 to 3 amperes. The analysis is finished at the end of twenty minutes and the quantity of arsenic estimated by comparing the spot with a standard scale. (See Method *a*.) If the apparatus is connected with a horizontal delivery tube, Sanger's method can be used. (See Method *b*.)

Remark.—As regards the influence of the cathode material, Thorpe recommends bright platinum foil and Hefti uses lead.

Polished platinum does not hold arsenic back, but platinum with a rough surface does, and since bright platinum becomes dull with use, it is easily possible for low results to be obtained. Experiments performed by Hefti in the author's laboratory showed that zinc alloyed with a trace of copper or platinum, bright platinum foil and lead did not hold back arsenic when used as the cathode; on the other hand, zinc in the presence of chloroplatinic acid and platinum foil with spongy platinum held back a considerable quantity of arsenic.

To determine arsenic in a mineral water, 100 c.c., or more if necessary, are evaporated to a small volume in a porcelain dish. The resulting solution is acidified with sulphuric acid, reduced with sulphurous acid, the excess of the latter expelled, and the analysis continued by one of the above three methods.

Determination of Larger Quantities of Arsenic as Arsine. Method of F. Hefti.

In the electrolysis of larger quantities of arsenic it was not possible, in the past, to recover all the arsenic in the form of arseniuretted hydrogen; some arsenic was deposited upon the cathode in the form of the element arsenic and was not transformed into arsine by the further action of the electric current. The quantity of arsenic deposited as metal depends upon the potential of the electric current at the electrodes, the temperature, and the concentration of the arsenic solution. At high potentials, low temperature, and low concentration of the solution, the quantity of arsenic deposited becomes zero and the yield of arseniuretted hydrogen is then quantitative. The estimation of the latter is best accomplished iodimetrically. If arseniuretted hydrogen is passed through a solution of iodine in potassium iodide, it is immediately oxidized to arsenic acid in the cold.

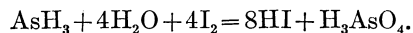

If the excess of iodine is titrated with sodium thiosulphate (see Iodimetric Methods) it is possible to determine the quantity of iodine that has reacted with the arsine. If T c.c. of 0.1N iodine were used at the start, and t c.c. of 0.1N thiosulphate

solution were used for the titration, then the quantity of arsenic or arsenic trioxide, present is

$$(T-t) \times 0.000937 \text{ gm. arsenic,}$$

$$(T-t) \times 0.001237 \text{ gm. As}_2\text{O}_3.$$

The apparatus necessary is shown in Fig. 42. The decomposition cell is also shown in Fig. 43 and consists of a wide U-tube, capable of holding 120 c.c. of solution. The tube is

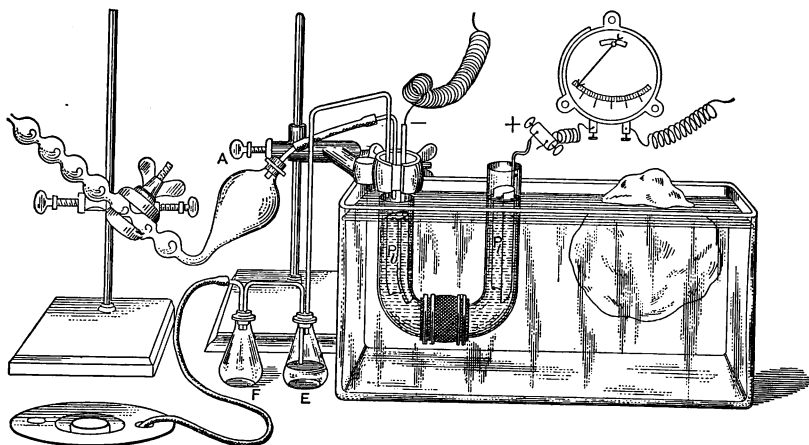

FIG. 42.

made in two halves, the edges of the bottom being ground so that they fit tightly together. Between these edges is placed a piece of thin parchment paper, the extending edges of which are folded over one side of the tube. A piece of rubber tubing holds the two halves of the U-tube together and also the parchment paper in place. This tubing is wired tightly in place, taking care that the edges of the parchment paper are also covered by the wire. In one arm of the tube (the anode compartment) which remains open during the whole experiment, is suspended a platinum plate electrode as anode, and the other arm (the cathode compartment) is tightly stoppered with a three-holed rubber stopper. Through one hole passes a glass tube containing mercury; at the bottom of this tube

a platinum wire is sealed in and from this a plate electrode of lead foil is suspended to serve as cathode. The wire from the negative pole of the battery dips into the mercury. Through the second hole in the stopper is passed a gas delivery tube leading to the absorption vessel *A*. The third hole in the stopper carries a tube that leads to the Erlenmeyer flask *E* which, in turn, is connected with the empty flask *F*, and the latter with the rubber tubing shown in Fig. 42. This tubing leads to the hood. Such an arrangement provides for the regulation of the

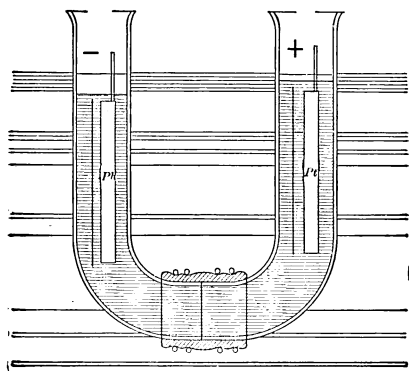

FIG. 43.

pressure in the cathode space. If the pressure there exceeds that of the anode space, a part of the arsenic solution will pass into the anode compartment and will be lost in the analysis. If suction is applied at the extreme end of the absorption apparatus, so that bubble after bubble of air passes through the Erlenmeyer, then it is very easy to overcome the pressure in the absorption vessel without having diminished the pressure in the cathode compartment enough to tear the parchment membrane.

Procedure.—The arsenic solution to be tested must contain all the arsenic in the trivalent condition.

In the first place, the anode compartment is filled to within 3 cm. of the top with 10 per cent. sulphuric acid, the arsenic solution is placed in the cathode compartment and this is filled to within 3.5 cm. of the top (in other words, the level in the

cathode compartment is about 0.5 cm. lower than on the other side of the U-tube); the concentration of the arsenic solution in the U-tube, after this dilution with acid, should not exceed 80 mgm. As_2O_3 in 50 c.c. of solution. The U-tube is placed in ice-water and the gas delivery tube is connected with two ten-bulb absorption tubes, of which only one is shown in the drawing. Into the first absorption tube is now placed an accurately measured volume of tenth-normal iodine solution, and into the second tube, which is not shown in the drawing, 10 c.c. of sodium thiosulphate solution, and about 40 c.c. of water. The purpose of the sodium thiosulphate solution is to catch any iodine that may escape from the first absorption tube. While the apparatus absorption vessels are being filled, the arsenic solution should be in the ice-water, and its temperature should be about 0° when the analysis is ready to begin. Gentle suction is started at the end of the second absorption tube, the electric circuit is closed* and the suction is regulated so that bubble after bubble of air slowly streams through the pressure regulator and into the cathode compartment throughout the whole duration of the electrolysis. Moreover, care is taken that enough ice remains in the cooling bath. When all the conditions are maintained satisfactorily, the liquid in the cell should remain perfectly clear, or at the worst be colored only by a slight brownish turbidity, which eventually disappears. If a black turbidity is formed that settles to the bottom of the U-tube, something has gone wrong and it is useless to continue the experiment. In a normal experiment, the evolution of the arsine is finished in an hour, when not more than 50 mgm. of As_2O_3 are present. The current is then stopped, the contents of the two absorption tubes (first the iodine and then the thiosulphate solution) are poured into a beaker containing 5 c.c. of a saturated solution of pure NaHCO_3 , and the excess of iodine is titrated with 0.1N sodium thiosulphate solution using starch solution as indicator. If on mixing the contents of the two absorption bulbs the solution is decolorized, the titration is finished with 0.1N iodine.

* A current of 2 to 3 amperes and 7 volts is used.

This method can be carried out very easily and gives accurate results in the presence of iron, so that it is suitable for a rapid determination of the arsenic present in iron minerals.

Determination of Arsenic in Mispickel.

One gram of the finely powdered mineral is fused in a nickel crucible with 6 gm. of sodium carbonate and 1 gm. of potassium nitrate. The resulting melt is extracted with hot water and the residue (Fe_2O_3 , NiO) washed with hot sodium carbonate solution. To the filtered solution 200 c.c. of water saturated with SO_2 are added to reduce the arsenic, the solution is boiled to expel the excess of SO_2 , allowed to cool, diluted to 500 c.c. with sulphuric acid so that the entire solution contains 10 to 12 per cent. of H_2SO_4 , and the arsenic is then determined as outlined above, using one-tenth of the solution.

Instead of extracting the melt with water, it may be treated with dilute sulphuric acid, whereby all the iron goes into solution. After this solution has been reduced with sulphurous acid, the analysis of an aliquot part gives the same result as when the first procedure is followed.

Hefti found 42.67 per cent. arsenic by the former process and 42.73 per cent. by the latter. The mineral analyzed was supposed to contain 42.72 per cent. arsenic.

ANTIMONY, Sb. At. Wt. 120.2.

Forms: Sb_2S_3 , Sb_2O_4 , and Sb.

i. Determination as Trisulphide, Sb_2S_3 .

Method of F. Henz.*

The best method for the determination of antimony is, in the author's opinion, the following:

Hydrogen sulphide is passed for twenty minutes into the cold solution of an antimonite or antimonate, then, without stopping the current of hydrogen sulphide, the solution is slowly heated to

* F. Henz, Z. anorg. Chem., 37, 18 (1903).

boiling and the gas passed through it for fifteen minutes more, after which the now dense precipitate is allowed to settle and filtered through a Gooch crucible which has been heated at 280–300° and weighed. The precipitate is washed four or five times by decantation with 50–75 c.c. of hot, very dilute acetic acid into which hydrogen sulphide has been passed, and washed on the filter with the same wash liquid until all chloride is removed. At first the filtrate runs through perfectly clear, but after all the mineral acid has been removed, the filtrate shows a slightly orange tint, owing to an unweighable amount of the antimony sulphide passing through in colloidal solution. As soon as this point is reached the washing is stopped.

F. Henz then proceeds as follows:

The crucible, after the precipitate has been dried as much as possible by suction, is placed in the tube *R*, Fig. 44, which is fitted to a drying oven (about 18 cm. long and 10 cm. high; covered with asbestos paper). The tube *R* is then closed with a rubber stopper that holds a glass delivery tube, and *R* is pushed into the drying closet until the end of the stopper is reached. To protect the rubber stopper during the subsequent heating, its inner surface is provided with a Rose crucible cover, which is held in place by wrapping the tube *a* with a strip of asbestos paper.

The air is now expelled from the tube by a stream of dry, air-free carbon dioxide* and heated for two hours at 100°–130°.

† In order to obtain accurate results it is necessary to have the carbon dioxide perfectly free from air. This may be prepared by the use of the Kipp generator as modified by Henz (Chem. Ztg., 1902, 386) see Fig. 45.

This differs from the ordinary form of the Kipp apparatus only as regards the siphon tube *a*; but herein lies a distinct advantage. The apparatus is charged as follows: First of all, pieces of pure marble are placed in the middle compartment, the stop-cock is opened, and water is poured through the upper compartment, until it begins to run out through the stop-cock, which is then closed. By this means all the air has been expelled from the lower parts of the apparatus and it only remains to introduce the hydrochloric acid. To accomplish this, the water is allowed to run out through the siphon while hydrochloric acid (1:4) is poured in at the top of the generator. As soon as carbon dioxide begins to be evolved, the tube *a* is closed and the apparatus is ready for use. When the acid has become

Inasmuch as the tube *R* extends so far into the drying oven, there is no danger of water condensing in the tube, but it is all expelled as vapor at *b*.

The precipitate is now dry and the air completely expelled from the heating tube.

The tube *R* is now withdrawn a little from the oven, about

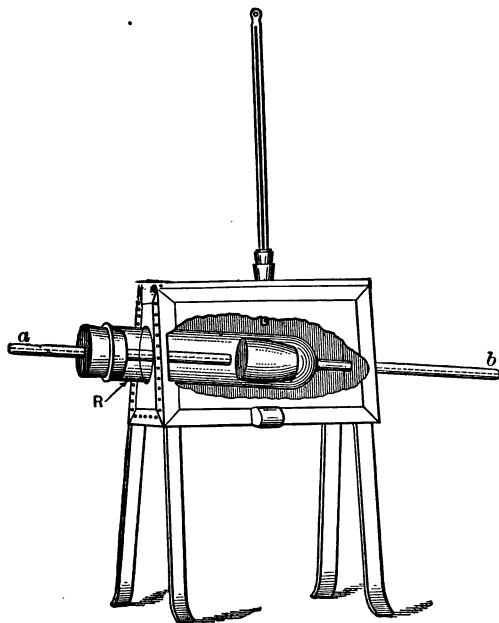

FIG. 44.

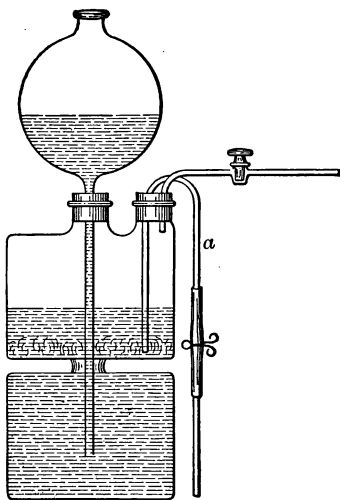

FIG. 45.

5 cm., as shown in the drawing, and the temperature is raised to 280–300° and kept there for two hours.

Hereby some sulphur is volatilized and collects in the tube *R* outside the oven. The antimony pentasulphide is also completely changed into the black modification of the trisulphide by this heating.* The crucible is allowed to cool in the stream of

too weak, it is removed through the siphon while a fresh supply is poured in at the top; there is no need of taking the apparatus apart during this operation. It is obvious that the same apparatus can be employed to advantage for generating hydrogen or hydrogen sulphide.

* According to Paul (*Z. anal. Chem.*, 31, 540 (1892)), the transformation of antimony pentasulphide can be accomplished in his drying oven (shown

carbon dioxide, transferred to the balance case,* and after standing half an hour is weighed. The black antimony trisulphide is not at all hygroscopic. A further heating in the current of carbon dioxide will rarely show any change in weight.

(b) **Method of Vortmann and Metzel.**

When antimony is precipitated by hydrogen sulphide from a hot solution which is strongly acid with hydrochloric acid, the sulphide eventually becomes grayish black in color, is crystalline, and can be filtered easily and washed with water without the slightest tendency to pass into the hydrosol condition.

The solution, in an Erlenmeyer flask, is treated with concentrated hydrochloric acid, adding 24 c.c. of the concentrated acid to each 100 c.c. of the neutral solution. It is heated to boiling, and the hot solution subjected to the action of hydrogen sulphide gas. The Erlenmeyer flask containing the solution is placed in a dish of boiling water and the water in the latter is kept boiling during the precipitation. It is advisable to introduce the hydrogen sulphide gas quite rapidly at first, but towards the end a slow stream is sufficient. The antimony sulphide as it comes down is yellow at first, but as the precipitation proceeds, it becomes redder; gradually it becomes heavier and denser, assumes a crystalline form and becomes darker, and finally black in color. The transformation into the crystalline form is hastened by shaking the flask. At first, while the precipitate is of a yellowish color, there is no need of shaking the flask but later on it is very desirable to do so. The shaking, however, should not be too violent, as otherwise some of the precipitate is likely to adhere to the upper portions of the flask and escape the transformation. The duration of the

in Fig. 20 of this book) by heating to a temperature of 230°. This is perfectly true, but the transformation takes place more readily at a temperature of 280°. It is more difficult to replace the air completely with carbon dioxide in Paul's drying oven and often some white antimony oxide is noticeable in the crucible.

* A piece of writing-paper should be rolled up and placed in the tube *R*, so that the crucible does not come in contact with any of the sulphur sublimate, on withdrawing it. The crucible is removed with the paper.

† *Z. anal. Chem.*, **44**, 526 (1905).

whole process amounts to from 30 to 35 minutes. Finally a heavy, dense, crystalline precipitate of antimony trisulphide is obtained which settles well and permits a rapid filtration. The solution is diluted with an equal volume of water, which is allowed to flow around the walls of the flask in order to wash down any adhering sulphide. The dilution almost always causes the formation of a slight yellow turbidity. The reason for this is that a little of the antimony is held in solution by the strong acid and as the solution is diluted this is caused to precipitate by the dissolved hydrogen sulphide. The flask is, therefore, once more shaken, placed in the vessel of boiling water and more hydrogen sulphide is introduced. In two or three minutes the solution above the precipitate will become clear. It is filtered through a Gooch crucible, washed with water to remove the acid, then with alcohol, and placed in the drying oven.

2. Determination as Tetroxide, Sb_2O_4 (Bunsen).

This method is based upon the fact that antimony pentoxide, when ignited at a definite temperature, changes into Sb_2O_4 . Bunsen,* who first proposed the method, later abandoned it because his assistant succeeded in volatilizing more than 0.1 gm. of the precipitate by heating it over the blast lamp.† Brunck,‡ Rössing§ and Henz|| have shown, however, that under certain conditions accurate results can be obtained, although they did not specify the exact temperature at which the precipitate should be ignited. If the pentoxide is ignited in a large porcelain crucible over the blast lamp, it is possible to change the antimony pentoxide quantitatively into the tetroxide; if, however, a small, thin-walled, porcelain crucible is used, the tetroxide loses oxygen and is transformed into the volatile trioxide, whereby low results are obtained. It is, therefore, purely accidental if exact results are obtained by such a procedure. In 1897, Baubigny¶ dis-

* Ann. Chem. u. Pharm., **106**, 3 (1858).

† *Ibid.*, **192**, 316 (1878).

‡ Z. anal. Chem., **34**, 171 (1895).

§ *Ibid.*, **41**, 9 (1902).

|| *Loc. cit.*

¶ Compt. rend., **124**, 499 (1897)

covered that antimony pentoxide is converted quantitatively into the tetroxide at a temperature of 750°–800° and begins to form the volatile trioxide at a little above 950°. The author's assistant, Dr. E. G. Beckett,* has confirmed the work of Baubigny. At 750°–800° the transformation is complete and at 1000° it is possible to volatilize 0.35 gm. of the precipitate in about thirty minutes. If these facts are borne in mind, it is possible to get accurate results, although even then the method is less satisfactory than the determination as trisulphide.

Procedure.—In the majority of cases it is desired to determine the amount of antimony present in a mixture of its tri- and pentasulphides, or in a mixture of one or the other of the two compounds with sulphur. It is best to proceed as follows: The sulphide of antimony, precipitated from hot solution, is washed first with hot water, then with alcohol, afterwards with a mixture of alcohol and carbon disulphide (in order to remove the sulphur),† again with alcohol and finally with ether, afterwards drying the precipitate. The bulk of the precipitate is separated from the filter and placed upon a watch-glass and the filter is placed in a small porcelain dish and boiled with a little of a freshly prepared solution of ammonium sulphide, stirring constantly with a glass rod. The resulting solution is poured through a small filter into a 30 c.c. porcelain crucible, and the filter is treated repeatedly with ammonium sulphide until it is no longer colored brownish red at the edge of the paper, where it begins to dry; the extraction of the antimony sulphide is then complete. The solution in the crucible is evaporated to dryness and the main part of the precipitate is added. To oxidize the antimony sulphide, Beckett places the crucible, with a dish of fuming nitric acid beside it, under a bell-jar and allows it to stand over night. The vapors of fuming acid slowly oxidize the precipitate in the crucible and in the morning it is possible to complete the oxidation by means of nitric acid (sp.gr. 1.4) without the reaction being too violent. The crucible is then heated on the water-bath until the precipitate becomes white and the greater part of the acid is

* Inaug. Dissert. Zurich, 1909.

† Thiele, Ann. d. Chem. und Pharm., 263, 372.

expelled. A little water is added and, with stirring, enough concentrated ammonia to give an alkaline reaction. The contents of the crucible are now evaporated to dryness on the water-bath, carefully heated in an air-bath (Fig. 11, p. 27) until no more fumes of sulphuric acid are evolved, and then for half an hour at 800° in an electric oven. After cooling in a desiccator, the crucible is transferred quickly to a glass-stoppered weighing beaker, allowed to stand twenty minutes in the balance case, and then weighed.* The ignition and weighing are repeated until a constant weight is obtained.

3. Determination of Antimony as Metal.

Antimony may be deposited from acid solutions by means of the electric current; the metal, however, does not adhere well to the electrode, so that this method cannot be used for its quantitative determination. On the other hand, the following method is suitable; it was first proposed by Parrodi and Mascazzini,† then modified by Luckow,‡ and afterwards improved by Classen and Reiss.§ According to the experience in the author's laboratory, it is not so accurate as the trisulphide method.

If a solution of sodium or ammonium sulphoantimonite, or antimonate, containing not more than 0.3 gm. Sb in a volume of about 140 c.c. is subjected to electrolysis with a current of 1–1.5 amperes at 70° for 90 minutes, the antimony will be deposited upon a platinum dish, which has been *gently* sand-blasted, as steel-gray, metallic antimony, and the deposit adheres so firmly that it can be dried and weighed without loss. The chief condition for the success of this operation is the absence of polysulphides. In case these substances are present the antimony is incompletely deposited and in some cases not at all, or the deposited antimony may pass into solution, on account of being oxidized to sodium

* Sb_2O_4 is hygroscopic and must be weighed in a weighing beaker, as Finkener, Dexter, and Beckett have all found.

† Z. anal. Chem., 18, 587 (1879).

‡ *Ibid.*, 19, 13 (1880).

§ Berichte, 14, 1629 (1881); 17, 2474 (1884); 18, 408 (1885); 27, 2074 (1894).

antimonite by means of the sodium polysulphide which is formed at the anode during the electrolysis:

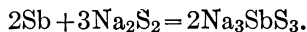

It is necessary, therefore, to prevent the formation of polysulphides during the electrolysis. For this reason Lecrenier* added sodium sulphide to the bath, whereby the polysulphide is transformed into thiosulphate:

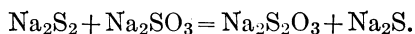

Ost and Klapproth † carry out the electrolysis with the aid of a diaphragm to keep the polysulphide away from the cathode.

It is better, however, to make use of potassium cyanide for this purpose. ‡

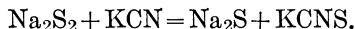

Procedure.—In most cases the antimony is first isolated as the sulphide, which is either precipitated by hydrogen sulphide from acid solution or obtained by acidifying an alkaline solution of the thio-salt. The filtered and washed precipitate, corresponding to not over 0.2 gm. Sb, is dissolved on the filter by pouring pure sodium sulphide solution (sp.gr. 1.14) over it.§

* A. Lecrenier, Chem. Ztg., **13**, 1219 (1889).

† Z. angew. Chem., **1900**, 828.

‡ Cf. A. Fischer, Ber., **36**, 2048 (1903); Z. anorg. Chem., **42**, 363 (1904); Hollard, Bull. Soc. Chem., **23** [3] 292 (1900); F. Henz, Z. anorg. Chem., **37**, 31 (1903).

§ A. Inhelder prepares the solution of sodium sulphide as follows: 666 gms. of purest sodium hydroxide (prepared from sodium) are dissolved in 2 liters of water and the solution divided into halves. One-half is placed in a long-necked flask of such a size that the solution just reaches the neck of the flask. The flask is closed with a two-holed rubber stopper and a rapid current of well-washed hydrogen sulphide is introduced through a glass tube 1 cm. wide, keeping out the air as much as possible. When the solution ceases to increase in volume (1000 c.c. of NaOH solution should give 1218 c.c. of sodium NaSH solution). When this is accomplished, the other half of the original sodium hydroxide solution is added. The solution of Na₂S thus prepared is colored a pale yellow, and after standing some time, or sooner

The solution is caught in a weighed platinum dish with unpolished inner surface, or in a beaker if a platinum gauze electrode is to be used. After washing the filter with the sodium sulphide solution, the total volume of the liquid in the platinum dish should not be over 80 c.c.; if less than this, enough more sodium sulphide solution is added. The solution is diluted with 60 c.c. of water and 2-3 gms. of the purest potassium cyanide are added and the liquid is stirred with the anode until all the cyanide has dissolved and the solution is well mixed. It is heated to 60°-70° and electrolyzed with a current of 1-1.5 amperes and electrode potential of 2-3 volts. After 1.5 to 2 hours all the antimony will be upon the cathode in the form of a firmly-adhering, light-gray deposit.* Now, without breaking the circuit, the electrolyte is siphoned off, while water is added until the current ceases to pass through the liquid (the voltmeter connected as ammeter points to the zero reading). The cathode is removed, washed thoroughly with water, then with absolute alcohol, dried at about 80°, cooled in a desiccator, and weighed.

The results obtained by this method are invariably too high, as F. Henz † showed in the author's laboratory, the error amount-

on shaking, tetragonal crystals of $\text{Na}_2\text{S} + 9\text{H}_2\text{O}$ are deposited. The solution keeps indefinitely in a well-stoppered flask; a slight precipitate of black metal sulphide (FeS , NiS , Ag_2S) is formed after some time.

If the sodium sulphide solution is prepared from caustic soda purified by alcohol, the final solution is colored a deep yellow or brown and it contains more foreign sulphides, partly in suspension and partly in colloidal solution. If the suspended sulphides are removed by filtration, a further precipitate will appear on standing.

For the antimony determination, the saturated sodium sulphide solution, which has a specific gravity of 1.22, is diluted until the specific gravity is 1.14. According to A. Classen, a satisfactory solution can be prepared by dissolving the purest grade of commercial Na_2S . Classen formerly recommended that the solution be prepared by boiling a solution of sodium hydroxide which had been saturated with hydrogen sulphide. Such a solution after an hour's boiling, while introducing a stream of hydrogen, contained 69 per cent. NaSH and 31 per cent. Na_2S (F. Wegelin).

* To make sure that the deposition is complete, the liquid may be transferred quickly to a second dish and electrolyzed for half an hour longer. It is seldom that there will be any gain in weight shown by this dish.

† *Z. anorg. Chem.*, **37**, 31 (1903).

ing to about 1.5 to 2 per cent. of the total antimony present. If, however, the antimony deposit is dissolved and precipitated as the trisulphide, the weight of the latter corresponds to the theoretical value, showing that the deposit contained all the antimony. If, as A. Fischer* recommends, the deposit is dissolved in alkali polysulphide, and again electrolyzed with addition of potassium cyanide, the same weight of antimony is obtained as at first, but the antimony is not pure.

The error in the analysis is so constant that values not far from the truth will be obtained by subtracting 1.6 per cent. of the weight of antimony deposited electrolytically.

This error of the electrolytic antimony determination was first detected by Henz, but has been confirmed by a number of other investigators, including O. M. M. Dormaar,† F. Förster and O. Wolff,‡ and recently by A. Inhelder.§

According to Dormaar, Förster and Wolff, the high values are due to the presence of a little sulphur and more oxygen. Förster and Wolff assert that the metal contains from 1 to 1.5 per cent. of oxygen. The error is greater in proportion to the quantity of free sodium hydroxide present in the electrolyte. According to the work of Scheen,|| which was suggested by Classen, the error is due to enclosed mother-liquor and is greater in proportion as the electrode surface is rough. Scheen, therefore, recommends a bright electrode surface, or one that is dulled but slightly.

A. Inhelder ¶ has carefully repeated the experiments of Scheen, using new, polished dishes, but has not been able to confirm Scheen's conclusions, D. Karl Mayr also obtained high values no matter whether the electrode surface was bright or dull.

Cleaning the Electrodes. Ost** recommends heating with a

* Berichte, **36**, 2348 (1903).

† Z. anorg. Chem., **53**, 349 (1907).

‡ Z. Elektrochem., **13**, 205 (1907).

§ Inaug. Dissert. Zürich, 1910.

|| Z. Elektrochem., **14**, 257 (1908).

¶ Inaug. Dissert. Zürich, 1910.

** Z. angew. Chem., **1901**, 827.

mixture of equal parts concentrated nitric acid and a saturated solution of tartaric acid. The antimony will also dissolve readily by heating with a solution of alkali polysulphide.

TIN, Sn. At. Wt. 119.0.

Forms: SnO_2 , Sn.

1. Determination of Tin Dioxide, SnO_2 .

Two cases are to be distinguished:

- (a) *The Tin is Present as Metal (in an Alloy).*
- (b) *The Tin is Present in Solution.*

(a) *The Tin is Present in an Alloy.*

Method I.

In case the tin is present in an alloy it may be treated according to the method of Busse* as follows:

About 0.5 gm. of the alloy, in the form of borings, is treated in a beaker with 6 c.c. of nitric acid (sp. gr. 1.5), 3 c.c. of water are slowly added and the beaker is then quickly covered with a watch-glass. As the water is mixed with the acid a violent reaction takes place. When the evolution of nitric oxide (brown vapors on coming in contact with the air) has ceased, the solution is heated to boiling and diluted with 50 c.c. of boiling water; the precipitate is allowed to settle completely, then filtered, washed, and dried. After burning the filter, moistening the ash with nitric acid and drying on the water-bath, the precipitate is ignited, at first gently and finally strongly, over a Méker burner, or a blast-lamp, in a porcelain crucible. It is weighed as SnO_2 .

The tin dioxide thus obtained is never pure; it always contains small amounts of other oxides and must be purified as follows: After weighing, the precipitate is mixed with six times as much of a mixture consisting of equal parts calcined sodium carbonate and pure sulphur, and this mixture is heated in a porcelain-covered crucible over a small flame until the excess of sulphur is almost entirely removed. This point is easily recognized by there being no longer any odor of SO_2 and no blue flame of burning sulphur

* Zeit. f. anal. Chem., 17, 53.

evident between the cover and the crucible. After cooling, the melt is treated with a little hot water, whereby the tin goes into solution* as sodium sulphostannate (cf. Vol. I, p. 260), together with some copper and iron. The deep-brown liquid, therefore, is treated with sodium sulphite † solution until it becomes only slightly yellow in color, after which any iron or copper, etc., will be quantitatively precipitated as sulphides. The latter are filtered off and washed, first with water to which a little sodium sulphide has been added and finally with hydrogen sulphide water. As a rule the amount of insoluble sulphide formed by this treatment is so small that after drying it can be ignited in an open porcelain crucible and changed to oxide without introducing any appreciable error. If this weight is subtracted from the original amount of impure stannic oxide, the weight of pure stannic oxide will be obtained. If, however, the amount of impurity present with the residue of metastannic acid should be large, the different metals must be separated, according to one of the methods for the separation of the sulphobases and the weight of each oxide determined separately, and the sum of their weights subtracted from the original weight of the tin dioxide. Instead of determining the amount of impurity present with the tin dioxide, the filtrate from the insoluble sulphides can be acidified with acetic acid and the tin precipitated as yellow stannic sulphide, which, after it has completely settled, is filtered off and changed by careful ignition in an open porcelain crucible, to tin dioxide, as described on p. 233, and weighed as such.

Method II.

The alloy is dissolved in nitric acid, the insoluble metastannic acid is filtered off and washed as in the first method. Instead of

* Frequently a single fusion with sodium carbonate and sulphur is insufficient; this is recognized by obtaining a sandy residue insoluble in water. In this case the residue is filtered, washed, dried, and the fusion repeated until all the tin is brought into solution.

† The sodium sulphite changes the sodium polysulphide to monosulphide, in which copper and iron sulphides are insoluble,

drying and igniting the precipitate, however, it is washed into a porcelain evaporating dish, evaporated on the water-bath almost to dryness, and then treated with 1 c.c. of pure sodium hydroxide solution and 10–15 c.c. of concentrated sodium sulphide solution (see foot-note, p. 225). The evaporating dish is covered with a watch-glass, and the dish with its contents is heated for about 45 minutes on the water-bath, whereby all the tin should pass into solution, and the other metals remain undissolved as sulphides; they are removed by filtration.

The filter, upon which the metastannic acid was filtered, still retains some of the precipitate. It is, therefore, laid in a second small evaporating dish, covered with about 1 c.c. of sodium sulphide solution* and heated on the water-bath. After half an hour, the tin should all be dissolved. The solution is poured through a small filter and the latter is washed with a little hot water.

The two filters are dried, ignited in a porcelain crucible, the ash treated with a small quantity of strong nitric acid and the resulting solution is added to that obtained by the solution of the alloy in nitric acid.

For the determination of the tin, the two solutions containing sodium thiostannate are combined, acidified with acetic acid and boiled to expel the hydrogen sulphide. The precipitated stannic sulphide is filtered off, washed once with water to remove the most of the alkali salts, then transferred back to the original beaker and dissolved in 10 c.c. of 50 per cent. caustic potash, and 1 gm. tartaric acid, these quantities sufficing for 0.1 to 0.2 gm. of tin. (The last traces of precipitate adhering to the filter are dissolved in a very little sodium sulphide solution.) To the solution, pure 30 per cent. hydrogen peroxide (Perhydrol, Merck) is added until the yellow liquid becomes perfectly colorless, then a cubic centimeter in excess. The solution is boiled for about ten minutes to make sure that the oxidation is complete, and that the excess of peroxide is decomposed. As soon as no more bubbles of oxygen are evolved, the solution is allowed to cool somewhat and 15 g. of oxalic acid dissolved in a little hot water are cautiously added. The warm solution is electrolyzed directly as described on page 234.

* Cf. p. 225, footnote.

The precipitated stannic sulphide, as obtained above by acidifying the sodium thio-stannate solution, may be ignited in a porcelain crucible and weighed as SnO_2 . The results are usually a little high and the method is not as accurate as the electrolytic determination. Cf. page 233; β .

Method III.

The translator prefers to use a more dilute nitric acid for dissolving the alloy than was recommended by Busse. It is possible to obtain, in this way, residues of metastannic acid which are fully as pure and the work is not as unpleasant as when the more concentrated acid is employed. This method is recommended for the analysis of phosphor-bronze.

Procedure.—0.5 gm. of borings are dissolved in a small beaker with 15 c.c. of nitric acid, sp. gr. 1.2. The solution is evaporated just to dryness on the water-bath, and the beaker removed as soon as this stage is reached. A mixture is prepared of 20 c.c. nitric acid sp. gr. 1.2, and 40 c.c. water and this is divided into three portions. The residue is treated successively with each portion of the above mixture, each time heating to boiling and decanting off the solution through a hardened filter paper. The washing is completed by boiling and decanting with a 1 per cent. solution of ammonium nitrate. As much of the precipitate as possible is allowed to remain in the original beaker, and the total volume of the filtrate should not exceed 150 c.c. The first portions of the filtrate are carefully examined for metastannic acid, refiltered if necessary, and each successive portion removed from below the funnel before new wash water is added.

The residue of slightly impure metastannic acid is treated as described under either of the above methods. In case Method II is chosen, however, it is advisable to treat the filters containing the residue from the sodium sulphide treatment with 15 c.c. of hot dilute nitric acid (7 c.c. HNO_3 , sp. gr. 1.2 and 8 c.c. water) instead of burning and treating with nitric acid as directed above. The resulting solution of the impurities that were originally present in the metastannic acid, is filtered and added in a porcelain crucible and the ash weighed as SnO_2 . The amount

thus found is added to the result obtained from the sodium thio-stannate solution.

Remark.—Sometimes a little metastannic acid is left undissolved by the treatment with alkaline sulphide. It is not safe, therefore, to discard the filters. In the analysis of phosphor-bronze, the copper, lead and phosphorus may be determined as described on page 239.

(b) *Tin is Present in Solution*

(α) *The Solution Contains Tin only.*

If the solution contains only tin in the form of stannic salt (chloride or bromide), a few drops of methyl orange are added and then ammonia until the pink color of the indicator is changed to yellow. Ammonium nitrate (obtained by the neutralization of 20 c.c. of concentrated ammonia with nitric acid) is added and the solution is diluted to a volume of 300 c.c., heated to boiling, filtered after the precipitate has settled, washed with hot water containing ammonium nitrate,* dried, ignited in a porcelain crucible, and weighed as SnO_2 .

Remark.—If the solution contains non-volatile organic acids, this method cannot be used for the determination of tin. In this case the tin must be first precipitated as sulphide by means of hydrogen sulphide (cf. p. 233). If the tin is not in solution as stannic salt, but as stannous salt, the solution must be first oxidized by the addition of bromine water until a permanent yellow color is obtained, after which the solution is neutralized with ammonia and treated as above described.

According to J. Löwenthal, tin may be precipitated from slightly acid stannic chloride or bromide solutions in the presence of ammonium nitrate. Methyl orange is added to the solution and then ammonia until a yellow solution is obtained; † dilute nitric acid is now added, drop by drop, until the solution just becomes pink again, more ammonium nitrate solution is added (20 c.c. of concentrated ammonia exactly neutralized with nitric acid), the solution is

* The ammonium nitrate prevents the formation of soluble, amorphous stannic acid; it "salts out" the precipitate (cf. Vol. I).

† The excess of acid cannot be removed by evaporation on account of the volatility of stannic chloride.

diluted to 300 c.c., boiled for some time, filtered, washed with water containing ammonium nitrate, dried, ignited, and weighed as SnO_2 . This method is employed when the solution contains small amounts of alkaline earths; they remain in solution. Sodium sulphate can be used instead of ammonium nitrate to "salt out" the tin precipitate, but although the tin will be quantitatively precipitated, some sodium sulphate will be also thrown down, so that high results will be obtained.

(β) *The Solution Contains, besides Tin, Metals of the Preceding Groups or Organic Substances.*

In this case, independent of whether the tin is present in the form of stannic or stannous salts, hydrogen sulphide is conducted into the dilute solution until it is saturated with the gas; the solution is allowed to stand until the odor of hydrogen sulphide has almost disappeared and then filtered. The precipitate is washed with a solution of ammonium nitrate (or ammonium acetate), dried, transferred as completely as possible to a porcelain crucible, and the ash of the filter added. The tin sulphide is at first gently heated in a covered crucible to avoid loss by decrepitation, and afterwards in an open crucible until the odor of sulphur dioxide is no longer perceptible. The temperature now is raised gradually until finally the full heat of a good Teclu burner is obtained or the crucible is heated over the blast-lamp. As tin dioxide holds fast to some sulphuric acid with great tenacity, after cooling the crucible somewhat a piece of ammonium carbonate the size of a pea is added, the crucible covered and again heated, after which it is weighed as SnO_2 . The heating with the addition of ammonium carbonate is repeated until a constant weight is obtained.

Remark.—F. Henz * in testing this method always obtained results which were a little too high. This is due to the fact that it is difficult to wash the stannic sulphide precipitate free from sodium salts. The author recommends, therefore, dissolving the well-washed stannic sulphide precipitate in a little sodium sulphide, transforming this solution into potassium stannioxalate, and determining the tin by electrolysis, according to page 234.

* Z. anorg. Chem., 37, 39 (1903).

2. Determination of Tin as Metal.

The electrolytic deposition of tin from a solution of the ammonium double oxalate gives excellent results.* It is necessary, however, that some free oxalic acid is always present while the solution is undergoing electrolysis. During the process, ammonium oxalate is changed by anodic oxidation into ammonium bicarbonate and carbon dioxide,

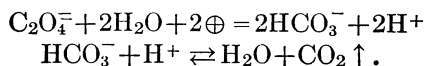

and the solution will smell of ammonia as a result of the hydrolysis of ammonium carbonate. When this point is reached no more tin is deposited. The ammonia often precipitates some stannic acid, which escapes the electrolysis. It is necessary, therefore, to avoid letting the bath become ammoniacal, and this is best accomplished by adding a little solid oxalic acid from time to time.

Procedure.—In the course of an analysis it is usually necessary to precipitate the tin from a solution of alkali thiostannate. This is best accomplished as follows: The thio-salt is decomposed by acidifying with acetic acid, the deposited sulphide dissolved in caustic potash solution, the solution oxidized with hydrogen peroxide, and finally acidified with oxalic acid, all exactly as described on page 230. The final solution, about 150 c.c. in volume, is heated to 60°–70° and electrolyzed with a current of 1 ampere and 3–4 volts potential at the electrodes; from time to time a little solid oxalic acid is added. At the end of about six hours all the tin will have been deposited upon a gauze electrode. The deposit is washed with water, exactly as prescribed for nickel on page 136, then with water, dried by holding above a flame, cooled in a desiccator, and weighed. The results are excellent.

Remark.—If ammonium oxalate is used in place of the potassium oxalate, the electrolysis requires more time (eight to ten

* Cf. Classen's "Quant. Anal. by Electrolysis" and his "Ausgewählte Methoden der analytischen Chemie."

hours). By the addition of hydroxylamine the duration of the electrolysis is shortened (Engel).

F. Henz proposed to prevent the bath becoming ammoniacal by adding sulphuric acid during the course of the electrolysis, but subsequent experiments have shown that it is better to proceed as described above. If too much sulphuric acid is added, all the tin is not precipitated. The chief conditions are the presence of enough oxalate and a slightly acid solution.

Separation of Arsenic, Antimony, and Tin from the Members of the Ammonium Sulphide Group.

The separation is effected by passing hydrogen sulphide into the acid solution of the above metals whereby arsenic, antimony, and tin are precipitated as sulphides, while the remaining metals remain in solution.

From an alloy, or the solid sulpho-salts of the above metals, arsenic, antimony, and tin may be readily volatilized by heating in a stream of chlorine; the chlorides of these three metals are readily volatile, while those of the remaining metals are only difficultly so.

Separation of Arsenic, Antimony, and Tin from Mercury, Lead, Copper, Cadmium, and Bismuth.

If the metals are all in solution, they are precipitated by means of hydrogen sulphide and the precipitated sulphides after being filtered and washed are treated with alkali sulphide solution. If mercury is present, ammonium polysulphide should be used, but in the absence of this metal sodium polysulphide works better (cf. Vol. I.)

If the metals of this group are in the form of an alloy (arsenic and mercury are seldom met with to any extent), the antimony and tin are separated from the remaining metals on treating the alloy with nitric acid. The tin is left behind as metastannic acid, insoluble in dilute nitric acid, with the antimony as nearly insoluble antimonic acid. In the presence of tin, all phosphorus and arsenic are thrown down in the insoluble residue as phosphate and arseniate of metastannic acid. The small

amount of the latter (and the remaining metals of this group) are precipitated by hydrogen sulphide and separated from the copper group by means of alkaline sulphide solution.

The separation of tin from the remaining metals of the group can be illustrated by a practical example.

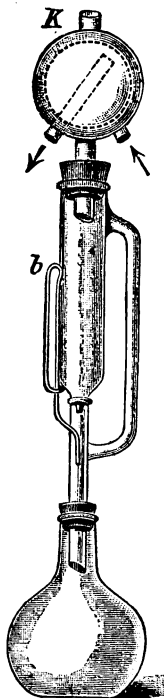

FIG. 46.

small amounts of copper oxide) is allowed to settle completely,

Analysis of Bronzes.

Method I.

A bronze is an alloy of tin and copper in varying proportions. It almost always contains besides these metals, more or less lead, aluminium, iron, manganese, zinc, and phosphorus.

Procedure.—About 0.5–1 gm. of the alloy in the form of borings* is placed in a beaker, treated with 6 c.c. of nitric acid, sp. gr. 1.5,† and 3 c.c. of water are added, after which the beaker is immediately covered with a watch-glass. When the reaction begins to diminish, the liquid is heated to boiling, until no more brown fumes are evolved, when 50 c.c. of boiling water are added; the precipitate (con-

taining all the tin, the phosphoric acid, and always

* The borings are usually somewhat oily, in which case they should be washed with ether that has been distilled over potash, dried at about 80°C ., and weighed after cooling in a desiccator. The washing with ether is best accomplished in a Soxhlet's fat-extraction apparatus, as shown in Fig. 46. The borings are placed in the extraction-tube, which is filled with ether nearly up to the bend *b* of the siphon-arm. The tube is then connected with the condenser *K*. After this from 20 to 30 c.c. of ether are added to the flask and this is heated gently on the water-bath. The ether vapors pass through the wide side-arm to the condenser *K*, where they are condensed and drop upon the borings. As soon as the ether in the tube has reached the height *b*, it is siphoned back into the flask, where it is again distilled. All the oil will be removed from the borings in from half an hour to an hour.

† See pages 228 and 231.

is filtered, washed with hot water, dried, ignited in a porcelain crucible, and weighed. In this way the weight of the $\text{SnO}_2 + \text{P}_2\text{O}_5 +$ foreign oxide is obtained. In order to obtain the weight of foreign oxide (chiefly copper oxide) the precipitate is fused with a mixture of sodium carbonate and sulphur as described on p. 228. The sulphides, remaining after the solution of the melt in hot water, are filtered off, converted into oxides by ignition in the air, and weighed. By subtracting this weight from that previously obtained, the weight of $\text{SnO}_2 + \text{P}_2\text{O}_5$ is obtained. In order to obtain the weight of the SnO_2 a separate portion is analyzed according to the method of Oettel as described below for phosphoric acid, and the amount of phosphoric anhydride subtracted from the weight of $\text{SnO}_2 + \text{P}_2\text{O}_5$.

The oxides obtained by the ignition of the insoluble sulphides are dissolved in a little nitric acid (in case Fe_2O_3 is present a little hydrochloric acid is also necessary) and the solution of the nitrates is added to the first filtrate from the impure metastannic acid. To this solution an excess of dilute sulphuric acid is added, and it is evaporated on the water-bath as far as possible and then heated over a free flame until dense, white fumes of sulphuric acid are evolved. After cooling, 50 c.c. of water and 20 c.c. of alcohol are added, the precipitate of lead sulphate is filtered off and its weight determined as described on p. 174. The filtrate from the lead sulphate is heated to remove the alcohol and the copper precipitated by means of hydrogen sulphide and weighed as Cu_2S according to p. 183. In the filtrate from the copper sulphide the iron, aluminium, and zinc (also manganese) will be found. It is evaporated to a small volume in order to expel the hydrogen sulphide, oxidized by the addition of a few drops of concentrated nitric acid, and the iron and aluminium separated from the zinc by means of a double precipitation with ammonia,* whereby the iron and aluminium are left behind as hydroxides

* If considerable zinc is present, the above separation is inexact. In this case the filtrate from the copper sulphide is treated with sodium acetate, heated to 60° , saturated with hydrogen sulphide, and the iron and aluminium determined in the filtrate, the zinc in the precipitate. If manganese is present in the alloy, it should be separated from iron and aluminium as described on pp. 149 to 155.

and are separated and determined according to p. 107. The zinc is precipitated from the filtrate after acidifying with acetic acid, by passing hydrogen sulphide into the boiling solution. The precipitated zinc sulphide is filtered off, dissolved in hydrochloric acid, evaporated to dryness in a weighed platinum dish, and transformed to oxide by heating with mercuric oxide by Volhard's method (cf. p. 142).

For the phosphorus determination Oettel* recommends the following procedure: From 2-5 gms. of the substance are dissolved, as before, in nitric acid, and the impure metastannic acid with all the phosphorus is filtered off, dried, and transferred as completely as possible to a porcelain crucible. The ash of the filter is added, and the contents of the crucible ignited. After cooling, the substance is mixed with three times as much solid potassium cyanide, the crucible covered, and the contents fused; the stannic oxide is reduced to metal,

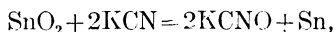

while the phosphoric acid is converted into potassium phosphate.

By skilfully rotating the crucible during the fusion, it is possible to unite the small particles of molten tin into a larger button whereby the subsequent filtration is greatly facilitated. After cooling, the melt is treated with water and filtered. The filtrate is cautiously treated with hydrochloric acid under a good hood and boiled to remove the hydrocyanic acid. It is then saturated with hydrogen sulphide in order to remove traces of copper and tin which almost always remain in the solution. The filtrate is freed from hydrogen sulphide by boiling, made ammoniacal, and the phosphoric acid precipitated as magnesium ammonium phosphate by the addition of magnesia mixture. After standing for twelve hours, the latter is filtered off, washed with 2½ per cent. ammonia water, dried, and changed by ignition to magnesium pyrophosphate, in which form it is weighed.

* Chemiker-Zeitung (1896), p. 19.

Ordinary bronzes may be analyzed very nicely in the following manner: The alloy is treated with nitric acid as described above, the metastannic acid removed by filtration and the filtrate electrolyzed, using a dull platinum dish as cathode, and a plate as anode, both of which are weighed. The electrolysis is carried out with a current of 1 to 1.2 amperes at about 60° and at the end of two and one-half to three hours the electrodes are washed without breaking the circuit. On the anode will be found all the lead as PbO_2 and on the cathode will be found the copper. The siphoned solution contains the iron, aluminium and zinc, which are determined as above. The phosphorus is determined in a special sample.

Remark.—The method just outlined will give exact results only when the metastannic acid is purified and the recovered solution of copper and lead nitrates added to the main solution. In the electrolysis, the chief dangers to be feared are having the solution so acid that the copper is not all precipitated, or so dilute that a spongy deposit is obtained.

Method II.

An excellent method for the analysis of phosphor bronze consists in dissolving the alloy as described under Tin, Method III., p. 231, and determining the tin as there described. The copper and lead are determined in the nitric acid solution by electrolysis with a current of 0.2 ampere, the copper being deposited on the cathode and the lead as peroxide on the anode. The electrolysis is usually finished in twelve hours, but it is well to clean the electrodes after weighing the deposits and then to test the solution with the current for an hour or so longer to see whether any lead or copper remains in the solution. Often a little more copper will be found, especially if the solution was a little too acid. During the electrolysis the concentration of the acid gradually diminishes so that eventually all the copper will be thrown down. The iron, aluminium, and zinc remain in solution, and are determined as above outlined.

For the phosphorus determination,* one gm. of the borings is weighed into a small beaker and dissolved in 20 c.c. of aqua

* Cf. Dudley and Pease, Eng. and R. R. Journ., March, 1894.

regia, made by mixing equal volumes of the concentrated acids just previous to use. The beaker is covered with a watch-glass, and, after solution is complete, the contents heated nearly to boiling for fifteen minutes. After cooling, 25 c.c. of water are added, and then just sufficient ammonia (sp. gr. 0.90) to redissolve the copper hydroxide* and to produce a deep blue colored solution; thereupon 50 c.c. of colorless ammonium sulphide are introduced. This should be enough to precipitate the sulphides, and the supernatant liquid should show no blue color. If it does, more ammonium sulphide must be added. The solution is digested at a temperature near the boiling-point for fifteen minutes, the precipitated sulphides of copper and lead allowed to settle, and then filtered into a 300 c.c. Erlenmeyer flask, decanting the clear liquid carefully from the precipitate, and finally throwing the precipitate upon the filter. When the filter has drained the filter and precipitate is returned to the beaker, 50 c.c. of ammonium sulphide wash water (one part colorless ammonium sulphide to three parts of water) are added, and the mixture is heated, and stirred occasionally, for ten minutes; it is then poured upon another filter, washed with 50 c.c. of ammonium sulphide wash water and allowed to drain completely. The total volume should not be over 250 c.c., but it is not necessary to evaporate in case this volume is slightly exceeded. To the filtrate 10 c.c. of magnesia mixture are added and the solution shaken. The flask is placed in ice water and allowed to stand with occasional shaking for two hours. The precipitate of magnesium ammonium phosphate is filtered upon a small filter and washed with ammonia water (one part 0.96 sp. gr. ammonia to three parts water) until nearly free from sulphide. 10 c.c. of hydrochloric acid (one part HCl, sp. gr. 1.20, to four parts water) are placed in the flask, taking care that all of the precipitate adhering to the walls of the flask is dissolved, and then poured through the filter, allowing the solution to run into a No. 1 beaker. The flask and filter are washed with 10 c.c. more of the same acid. 3 c.c. of magnesia mixture are added to the filtrate, which is heated to boiling, removed from the flame, and then treated with ammonia (sp. gr. 0.96 = 10 per cent. NH_3) until the latter is present in large excess.

* A precipitate of lead or tin hydroxide remains insoluble.

The solution is allowed to stand in ice water for two hours, and is stirred occasionally. The precipitate is then filtered and washed with $2\frac{1}{2}$ per cent. ammonia water until free from chlorides, and ignited with the usual precautions, weighing as $Mg_2P_2O_7$.

SEPARATION OF THE SULPHO-ACIDS FROM ONE ANOTHER.

I. Arsenic from Antimony.

(a) Method of Bunsen.*

Principle.—If a slightly acid solution of an alkali arsenate and antimonate is treated with hydrogen sulphide in the cold and the excess of the latter immediately removed by conducting air through the solution, the antimony is quantitatively precipitated as pentasulphide, while the arsenic remains in solution.

Procedure.—Assume the arsenic and antimony to be present in the solution as arsenious and antimonous acids. Both elements are precipitated by hydrogen sulphide, filtered, and washed with water. The greater part of the precipitate is transferred by means of a spatula to a 200-c.c. porcelain casserole, and the precipitate remaining on the filter is dissolved into the casserole by dropping a solution of hot dilute pure caustic potash upon it. From 3–5 gms. of pure solid caustic alkali are added, and the precipitate dissolves to a clear solution.†

The casserole is now covered with a perforated watch-glass. It is placed upon the water-bath, and chlorine is conducted into the solution until all the alkali is decomposed; this takes from one-half to three-quarters of an hour. By this operation the arsenite and antimonite are oxidized to arsenate and antimonate and a small amount of potassium chlorate is formed. Concentrated hydrochloric acid is now added to the warm solution drop by drop from a pipette until all the chlorate is decomposed and no more chlorine is evolved. The watch-glass is removed, the solution is evaporated to half its volume, and then an equal amount of concentrated hydrochloric acid is added and the solution again

* Ann. d. Chem. und Pharm., 192, 305.

† If alkaline earths were the only metals present besides the arsenic and antimony, the first precipitation with hydrogen sulphide would be omitted.

evaporated to half its volume. The contents of the casserole are washed by means of dilute hydrochloric acid into a large beaker, diluted with water to a volume of 600 c.c. and for every decigram or less of the antimony 100 c.c. of freshly prepared hydrogen sulphide water are added. An orange precipitate of antimony pentasulphide is formed at the end of a short time. A strong current of air (filtered through a wad of cotton) is then passed through the solution without delay until the excess of hydrogen sulphide is completely removed; this usually requires about twenty minutes. In order to avoid loss during this operation a large beaker should be used to contain the solution and it should be covered with a perforated watch-glass. The precipitate of antimony pentasulphide is likely to contain traces of arsenic pentasulphide so that it is dissolved once more in caustic potash and the above operation repeated. The precipitate now obtained will be pure antimony pentasulphide. It is filtered through a Gooch crucible, dried at 280° C. in a stream of carbon dioxide as described under antimony, and weighed as Sb_2S_3 .*

For the arsenic determination, the combined filtrates are concentrated somewhat by evaporation, a few drops of chlorine water are added and hydrogen sulphide is passed into the warm solution (being kept on the water-bath) for from six to eight hours, after which it is allowed to cool in a rapid stream of hydrogen sulphide. After allowing the precipitate to settle for twenty-four hours, it is filtered through a Gooch crucible, washed with water, then three times with alcohol, four times with a mixture of pure carbon bisulphide and alcohol (cf. p. 180), and finally three times with pure alcohol. After drying at 110° C., the precipitate is weighed as As_2S_5 .

Remark.—If the solution contains no very large excess of hydrogen sulphide, the precipitate will always contain trisulphide, so that it is safer to dissolve it in ammoniacal hydrogen per-

* Bunsen weighed the antimony as pentasulphide after washing with carbon bisulphide. As, however, antimony pentasulphide is likely to be changed to the trisulphide on treating with carbon bisulphide, the above procedure is better. According to Braun, Sb_2S_3 is reduced to Sb_2S_2 on long-continued treatment with CS_2 .

oxide* and then to precipitate the arsenic with magnesia mixture as magnesium ammonium arsenate, as described on p. 206; weighing it as $Mg_2As_2O_7$.

Remark.—The method gives very accurate results, but consumes considerable time.

(b) *Method of Fred. Neher.*†

This, in the author's estimation, the best method for the separation of arsenic and antimony, depends upon the fact that arsenic is precipitated from a solution strongly acid with hydrochloric acid by a rapid stream of hydrogen sulphide, while antimony is not.

Procedure.—Starting with a precipitate consisting of the trisulphides of arsenic and antimony, this is dissolved in caustic potash solution and oxidized exactly as described under the previous method. When free from chlorate, the acid solution is washed into an Erlenmeyer flask and cooled by surrounding the flask with ice. In another flask some concentrated hydrochloric acid (sp. gr. 1.2) is likewise cooled. When both solutions are at 0° C., the arsenic antimony solution is diluted with twice its volume of the strong hydrochloric acid. Into this cold solution a rapid stream of hydrogen sulphide is passed for one and one-half hours. The flask is stoppered up and allowed to stand one to two hours. The As_2S_5 is filtered through a Gooch crucible and washed with hydrochloric acid (1 vol. water, 2 vols. concentrated hydrochloric acid) until 1 c.c. of the filtrate after being considerably diluted with water and tested with hydrogen sulphide shows no precipitation. It is then washed with water, and

* For this purpose as much of the precipitate as possible is placed in a beaker, the portion adhering to the filter is dissolved by hot ammonia into the same beaker, and this is warmed until the precipitate has entirely dissolved. After this, for every 0.1 gm. of As_2S_5 , 30-50 c.c. of pure 3 per cent. H_2O_2 are added, the solution heated for some time on the water-bath and then boiled ten minutes.

† Z. anal. Chem., 32, 45.

finally with hot alcohol. After drying at 110° C., the precipitate is weighed as As_2S_5 .*

The filtrate from the arsenic sulphide is diluted largely with water and saturated with hydrogen sulphide. The Sb_2S_5 is filtered through a Gooch crucible, dried at 280° C. in a current of carbon dioxide and weighed.

(c) *The Tartaric Acid Method.*

Principle.—The separation is based upon the fact that if magnesia mixture is added to a solution of an alkali arsenate and antimonate containing tartaric acid, only arsenic will be precipitated.

Procedure.—The sulphides are oxidized as described under (a) by solution in aqueous caustic potash and introduction of chlorine. The solution thus obtained is made acid, treated with tartaric acid and an excess of ammonia added. This should not cause any turbidity. If a precipitate is formed, it shows that an insufficient amount of tartaric acid is present. In this case the clear solution is decanted off, the precipitate is dissolved by warming with tartaric acid, and the two solutions are mixed. To the clear, ammoniacal solution, magnesia mixture is added slowly with constant stirring (cf. p. 206. foot-note). After standing twelve hours, the precipitate of magnesium ammonium arsenate is filtered off (it usually contains a little basic magnesium tartrate), washed a few times with $2\frac{1}{2}$ per cent. ammonia, dissolved in hydrochloric acid, and reprecipitated by the addition of an excess of ammonia. After standing for twelve hours more, the precipitate is filtered, washed with $2\frac{1}{2}$ per cent. ammonia, and weighed as magnesium pyroarsenate as described on p. 206,

* If the solution was not cold, some arsenic trisulphide will be found in the precipitate. The results are scarcely affected, however, when the precipitate is merely washed with water and alcohol, because the free sulphur is weighed with the sulphide of arsenic. If, however, the precipitate is washed with CS_2 , it is evident that the results will be too low. For the highest degree of accuracy, it is advisable to dissolve the precipitated sulphide in ammoniacal hydrogen peroxide, or in fuming nitric acid, and to determine the arsenic as $\text{Mg}_3\text{As}_2\text{O}_7$ as described on page 206.

Remark.—Arsenic can also be separated from tin according to the above method, except that more tartaric acid is necessary to prevent the precipitation of the tin than is the case when antimony alone is present (cf. p. 255).

(d) *Method of E. Fischer.**

Principle.—This separation depends upon the ready volatility of arsenic trichloride in a current of hot hydrochloric acid gas, under which conditions antimony chloride is not volatile. If the arsenic is present as arsenic acid, which is usually the case, the distillation must take place in the presence of some reducing agent.†

Procedure.—The apparatus shown in Fig. 47 is used for this determination. In the course of analysis, the arsenic and antimony, as a rule, are obtained first in the form of the sulphides, and these are dissolved, as described under (a), in caustic potash solution and oxidized by chlorine. Instead of using chlorine, the alkaline solution may be boiled with hydrogen peroxide or potassium percarbonate. If the latter method is used for the oxidation, the boiling must be continued until there is no further evolution of oxygen.

The oxidized solution is transferred, by means of a long-stemmed funnel, to the 500-c.c. distilling flask, A, in which has been placed 1.5 gms. of potassium bromide;‡ the solution is diluted in the flask with fuming hydrochloric acid to a volume of about 200 c.c. The receiver, V, consists of a large flask of from

* Z. anal. Chem., 21, 266. The process as described is the modification of M. Rohmer, Ber., 34, 33 and 1565 (1901).

† Fischer used a ferrous salt, O. Piloty and A. Stock used hydrogen sulphide (Ber., 30, 1649), and Friedheim and Michaelis used methyl alcohol (Ber., 28, 1414).

‡ Instead of the potassium bromide, hydrogen bromide may be used which has previously been prepared by treating 1 gm. of bromine with sulphurous acid. It is not permissible to introduce the bromine into the flask, A, in order to convert it to hydrogen bromide by introducing sulphur dioxide gas into the flask, because it is then possible for bromine vapors to get into the receiver by means of the air which is first expelled from the apparatus, and the bromine would oxidize the volatilized AsCl_3 , and thus interfere with the subsequent determination of the arsenic by precipitation as the trisulphide, or by titration.

1.5–2 liters capacity; it is kept surrounded by a current of cold water coming from the condenser and contains at the start, 800 c.c. of cold distilled water. Then, with the apparatus all connected as shown in the drawing, the distilling flask is heated and its contents partially distilled in a current of hydrogen chloride,* meanwhile constantly passing a little sulphur dioxide into the flask, until at the end of about forty-five minutes, the volume of

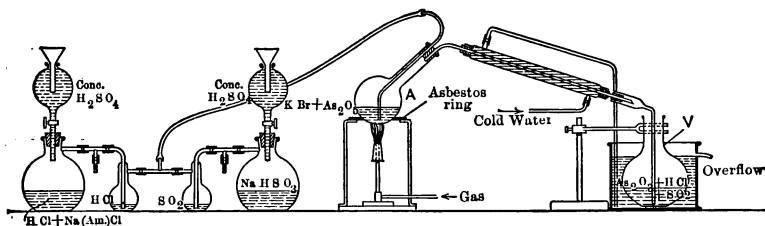

FIG. 47.

liquid in A is reduced to about 40 c.c. The flame is then removed and the T-tube between the two evolution flasks removed in order to prevent liquid from backing up into the wash bottles. The adapter tube which connects the condenser with the receiver is rinsed off and the receiver removed.

A new receiver is now placed at the end of the apparatus and a second distillation is made in order to make sure that all of the arsenic has been volatilized.† Then, for the determination of the arsenic, the contents of the two receivers are each diluted to a volume of about 1250 c.c., and the excess of sulphurous acid is removed by heating to boiling and passing a stream of carbon dioxide through the liquid as is shown in Fig. 48. When the sulphur dioxide has all been expelled (as can be shown by inserting a stopper with delivery tube into the flask so that the escaping vapors can be led into a dilute sulphuric acid solution of decinormal permanganate which will be decolorized by sulphur dioxide), the solution is allowed to cool and the arsenic determined as trisulphide according to the directions on p. 205 and weighed

* If there is any tendency to suck back, a little more sulphur dioxide should be introduced.

† Rohmer found that as much as 0.15 gm. arsenic was volatilized completely by one distillation.

as As_2S_3 after treatment with CS_2 (pp. 170, 223), or it may be titrated with iodine.

Determination of Arsenic by Titration.

The solution is treated with a few drops of phenolphthalein and solid potassium hydroxide is introduced until a permanent pink color is imparted to the liquid. The solution is then decolorized by the addition of a few drops of hydrochloric acid; 5 gms. of sodium bicarbonate are added, and the solution titrated with decinormal iodine solution as described on p. 688.*

The antimony is determined by treating the contents of the distilling flask with 2 or 3 gms. of tartaric acid, washing the

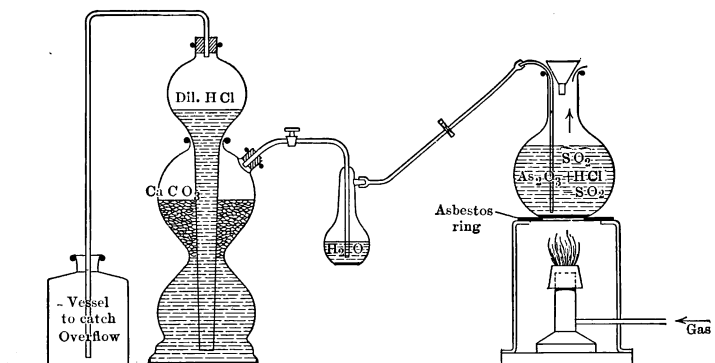

FIG. 48.

solution into an Erlenmeyer flask, expelling the sulphur dioxide as above,† and determining the antimony gravimetrically by precipitating as the trisulphide according to the directions on p. 218, or it is estimated volumetrically by titration with iodine as described on p. 688.

* A blank determination should be made with all the reagents that are to be used, and the iodine solution must be standardized in a solution as dilute as that in which the analysis is made.

† The escaping gas will not decolorize a solution of 2-3 c.c. dilute sulphuric acid and one drop of 0.01N. KMnO_4 , when all the SO_2 is expelled.

Determination of Arsenic in Commercial Sulphuric Acid.

About 30 c.c. of concentrated hydrochloric acid and a little potassium bromide, or hydrogen bromide, are placed in the distilling flask *A* (Fig. 47), whereupon 50 to 100 gms. of the acid to be tested (the weight is determined by difference) is introduced through a funnel that is fastened by means of rubber tubing to the upper end of the delivery tube which enters the flask;* the funnel is rinsed with concentrated hydrochloric acid, and the distillation begun.

When the contents of the distilling flask have been concentrated so that concentrated sulphuric acid remains, the acid is kept hot by means of a small flame until all of the arsenic has been expelled. On account of the high temperature, 1 gm. of arsenic will be driven over in about fifteen minutes. The analysis is finished as described above.

Separation of Antimony from Tin.

(a) *F. W. Clarke's † Method.*

Of all the present known methods for the separation of antimony from tin this is probably the most accurate. It depends upon the fact that antimony is completely precipitated from a solution containing oxalic acid, while stannic salts are not. Stannous sulphide, however, is decomposed by oxalic acid, forming an insoluble crystalline stannous oxalate, so that the tin must be in the stannic form.

* When the concentrated sulphuric acid runs into the flask, it often happens that distillation begins to take place and some of the arsenic would be lost if the flask, *A*, were left open.

† Chem. News, Vol. 21, p. 124. Cf. also Rössing, *Zeitschr. für anal. Chem.*, XLI, 1. F. Henz, *Z. anorg. Chem.*, 37, 18 (1903). Vortmann and Metz, *Z. anal. Chem.*, 44, 525 (1905).

Procedure.—In the majority of cases it is a question of separating antimony from tin after these metals have been separated from the members of the copper group by means of alkaline polysulphide; i.e., the tin and the antimony are in the form of their soluble sulpho-salts.

The solution of the sulpho-salts, containing not more than 0.3 gm. of the two metals, is placed in a 500-c.c. Jena beaker and treated with a solution of 6 gms. of the purest caustic potash (one-third the sum of the weights of tartaric and oxalic acids to be added) and 3 gms. of tartaric acid (ten times the maximum weight of the two metals). To this mixture 30 per cent. hydrogen peroxide is added slowly until the yellow solution is completely decolorized; then 1 c.c. in excess is added and the solution is boiled for a few minutes to change any thiosulphate to sulphate and to decompose the greater part of the excess peroxide. As soon as the evolution of oxygen ceases, the solution is cooled somewhat, the beaker covered with a watch-glass, and a hot solution of 15 gms. pure recrystallized oxalic acid is cautiously added (5 gms. for 0.1 gm. of the mixed metals). This causes the evolution of considerable gas ($\text{CO}_2 + \text{O}_2$). Now, in order to completely remove the excess of hydrogen peroxide, the solution is boiled vigorously for ten minutes. The volume of the liquid should amount to from 80 to 100 c.c. After this a rapid stream of hydrogen sulphide is conducted into the boiling solution, and for some time there will be no precipitation, but only a white turbidity formed. At the end of five or ten minutes the solution becomes orange-colored and the antimony begins to precipitate, and from this point the time is taken. At the end of fifteen minutes the solution is diluted with hot water to a volume of 250 c.c., at the end of another fifteen minutes the flame is removed, and ten minutes later the current of hydrogen sulphide is stopped. The precipitated antimony pentasulphide is filtered off through a Gooch crucible which, before weighing and after drying, has been heated in a stream of carbon dioxide at 300°C . for at least one hour. The precipitate is washed twice by decantation with 1 per cent. oxalic acid and twice with very dilute acetic acid before bringing it in the crucible.

Both of these wash liquids should be boiling hot and saturated with hydrogen sulphide.

The crucible is heated at 280°–300° in a current of carbon dioxide (free from air) to constant weight and its contents weighed as Sb_2S_3 .

To determine the tin, the filtrate is evaporated to a volume of about 150 c.c., the excess of oxalic acid nearly neutralized with ammonia and the tin deposited electrolytically as described on p. 234.

According to Vortmann and Metzl,* antimony may be separated from tin by passing hydrogen sulphide into a solution containing hydrochloric and phosphoric acids of the proper concentration.

(b) *Method of H. Rose.*

Principle.—This method is based upon the insolubility of sodium metantimonate and the solubility of sodium stannate in dilute alcohol.

Procedure.—Both metals are assumed to be present in the form of an alloy. The alloy is treated with nitric acid, whereby the antimony and tin are left in the form of their oxides (cf. pp. 228, 231, and 236). The residue is filtered off, washed with ammonium nitrate water, dried, transferred as completely as possible to a large silver crucible and the ash of the filter added, after which the precipitate is gently ignited. From ten to twelve times as much solid sodium hydroxide and a little sodium nitrate, or better, sodium peroxide, are added and the silver crucible is placed within a larger porcelain one in order to protect it from the flame: the contents are fused and kept liquid for twenty minutes. After cooling, the crucible is placed in a large porcelain dish and its contents treated with hot water until the melt has disintegrated, leaving the insoluble part in the form of a fine meal. One-third of the solution's volume of alcohol (sp. gr. 0.833) is now added, the mixture is well stirred and filtered after standing twelve hours. The residue remaining

* Z. anal. Chem., 44, 533 (1905).

on the sides of the dish is washed onto the filter with dilute alcohol (1 vol. alcohol+2 vols. water). The sodium metantimonate is washed first with a mixture of 1 vol. alcohol+2 vols. water, then with 1 vol. alcohol+1 vol. water, and finally with 3 vols. alcohol+1 vol. water,* until the filtrate when acidified with hydrochloric acid and tested with hydrogen sulphide no longer gives a yellow coloration (tin sulphide).

If considerable tin and little antimony were originally present, a single fusion of the oxides with caustic soda does not afford a complete separation, as the residue of sodium pyroantimonate always contains some tin. It is, therefore, dried, separated from the filter and placed in a silver crucible. The filter is treated repeatedly in a *porcelain* crucible with fuming nitric acid until the paper is completely destroyed and the excess of acid is then removed by heating in an air-bath. The contents of the porcelain crucible are subsequently dissolved in a little caustic soda solution and washed into the silver crucible; the water is then removed by heating the silver crucible at first on the water-bath and finally in an air-bath. Ten grams of solid caustic soda are now added, the mixture fused, and the melt treated in the same way as before.

The second residue of sodium metantimonate is free from tin. It is dissolved from off the filter by a mixture of hydrochloric and tartaric acids,† in which it is readily soluble. From this solution the antimony is precipitated by hydrogen sulphide and determined as described on p. 218. For the tin determination, the alcoholic filtrate is gently heated to remove the alcohol, acidified slightly with hydrochloric acid, and the tin precipitated as sulphide by hydrogen sulphide and determined according to p. 233, β .

Remark.—If the oxide residue which was first fused with sodium hydroxide and nitre consisted solely of tin and antimony oxides, this method gives very good results. As a rule, however,

* A few drops of sodium carbonate solution should be added to all the alcoholic wash liquids.

† A mixture consisting of equal volumes dilute hydrochloric acid (1:4) and 5–10 per cent. tartaric acid is used.

most antimony and tin alloys contain lead and other metals whose oxides remain to some extent with the tin and antimony on treatment of the alloy with nitric acid, so that the sodium metantimonate is subsequently rendered impure by the presence of these metals. The antimony determination therefore gives too high results. In this case the method of W. Hampe * should be used.

The alloy is dissolved in aqua regia (as described below in the analysis of bearing metal) and the tin and antimony separated from the remaining metals by means of colorless sodium sulphide. From the solution of the sulpho-salts the tin and antimony are precipitated by making barely acid with dilute sulphuric acid; the precipitate is washed and dissolved in a little warm sodium sulphide. After cooling, sodium peroxide is added to the concentrated solution in small amounts until the liquid becomes colorless, and when treated with more sodium peroxide a distinct evolution of oxygen takes place. By this treatment sodium antimonate is formed; this separates out to some extent, while the tin remains in solution. In order to completely precipitate the antimony from the solution, one-third as much alcohol (sp. gr. 0.833) is added, after which the precipitate is filtered off and treated as above described.

Analysis of Bearing Metal.

This alloy contains tin, antimony, lead and a little copper and usually small amounts of iron, bismuth and zinc.

One gram of thin borings is treated with 15 c.c. of concentrated hydrochloric acid in a small beaker. If the alloy is rich in lead it is necessary to heat on the water-bath for some time, replacing the acid lost by evaporation. Finally add less than 3 c.c. of strong nitric acid, a few drops at a time, to complete the solution. When the metal has dissolved, the solution (it should be yellow, or greenish yellow if much copper is present) is diluted with 15

* Chem. Ztg., 18, p. 1900.

times as much alcohol, added in small portions with constant stirring.*

After standing for twelve hours, and stirring frequently, the precipitated lead chloride is filtered into a weighed Gooch crucible, washed with absolute alcohol, dried at 150° and weighed. In the filtrate will be found a few milligrams of lead in the presence of antimony, tin, copper, bismuth, iron and zinc.† The alcoholic filtrate is poured into a large, deep porcelain dish ‡ and the alcohol is evaporated off at as low a temperature as possible. It is necessary to avoid evaporating the solution to dryness as in that case some SnCl_4 will be volatilized. When the alcohol is all gone, 0.1 gm. of potassium chlorate is added, the solution is evaporated to a small volume and then there is added one gm. of tartaric acid and enough caustic potash to make the solution barely alkaline. It is now treated, as recommended by Finkener, with freshly prepared hydrogen sulphide water until no further precipitation takes place. In this way all the Cu, Bi, Fe, Zn and the last of the Pb are precipitated as sulphides (precipitate *a*) while all the Sn and Sb remain in solution (solution *b*).§

* This stirring is indispensable because lead chloride separates out very slowly from a supersaturated alcoholic solution containing other chlorides. The complete precipitation is best recognized by the fact that no mark is left upon the sides of the beaker when the stirring rod is rubbed against it.

† Alloys low in lead are not treated with alcohol in this way. In such cases it is best to decompose the alloy with chlorine gas, as described in the analysis of tetrahydrite on page 359.

‡ In evaporating off the alcohol there is a tendency for the solution to creep over the edges of the dish so that it is advisable to employ a deep dish and to evaporate the liquid in small portions.

§ The separation is complete only when all the tin is in the quadrivalent condition. In driving off the alcohol there is always some stannous chloride formed which must be subsequently oxidized by means of KClO_3 and HCl .

Treatment of Precipitate a.

The precipitate is filtered off, washed with hydrogen sulphide water, dissolved in nitric acid (sp. gr. 1.2) and evaporated with hydrochloric acid to remove the nitric acid, and the solution of chlorides diluted so that its acidity corresponds to 1 part HCl (sp. gr. 1.12) to 25 parts water. The Cu, Pb, and Bi are precipitated as sulphides by hydrogen sulphide, filtered and washed with water containing H₂S. The filtrate contains the iron and zinc (Filtrate c).

The precipitate is dissolved in nitric acid, evaporated with the addition of 4 or 5 drops of concentrated sulphuric acid, and the last of the lead determined as sulphate according to p. 174. From this filtrate the bismuth is precipitated with an excess of ammonia and determined as Bi₂O₃ according to p. 179.

In the ammoniacal filtrate from the bismuth precipitation, the copper is determined electrolytically, after acidifying with sulphuric acid, according to p. 187, or as cuprous sulphide, according to p. 183.

To determine the iron and zinc, the *Filtrate c* is oxidized by boiling with a few drops of concentrated HNO₃ and the iron precipitated by an excess of ammonia and weighed as Fe₂O₃, p. 87. The zinc is determined in this last filtrate by acidifying with acetic acid, precipitating as sulphide and weighing as such, according to p. 143.

Treatment of Solution b.

To determine the antimony and tin, the alkaline solution is diluted to exactly 250 c.c. in a measuring flask, and after thoroughly mixing, 100 c.c. is withdrawn in a pipette, transferred to a 400-c.c. beaker, acidified with acetic acid, and boiled to expel the hydrogen sulphide. Then 3 gms. of tartaric acid and 6 gms. of purest potassium hydroxide are added, whereby any precipitated sulphide is redissolved. At this point some 30 per cent. hydrogen peroxide is allowed to run slowly into the solution, until the yellow color disappears, then 2 or 3 c.c. in excess are added and the solution boiled a few minutes. Then.

for each 0.1 gm. of metal present (Sb + Sn), 5 gms. of pure oxalic acid are added, the solution boiled ten minutes and the antimony separated from the tin as described on p. 248. From the filtrate the tin is determined electrolytically. For this purpose the oxalic acid solution is evaporated to a volume of about 200 c.c. and electrolyzed with a gauze electrode. At the end of six hours the deposition is complete. The electrodes are washed as described on p. 136, dried and weighed.

Remark.—Rössing's method,* which was recommended in the earlier editions of this book, is not altogether satisfactory. Usually the lead results are too high and the tin too low, on account of the lead sulphide precipitate being contaminated with tin.

Separation of Arsenic from Tin and Antimony.

(a) *Method of Fred. Neher.* †

The moist sulphides are dissolved in freshly-prepared ammonium sulphide, evaporated in an Erlenmeyer flask nearly to dryness and oxidized with hydrochloric acid and potassium chlorate. From this solution the arsenic is precipitated as sulphide under the conditions described on p. 243. In the filtrate from the arsenic pentasulphide all of the tin is found and can be precipitated as sulphide after diluting largely with water and passing in hydrogen sulphide. It is finally changed to the oxide as described on p. 233, β.

(b) *Method of W. Hampe.* ‡

The precipitated sulphides are dissolved as soon as possible in freshly-prepared ammonium sulphide, the solution is evaporated almost to dryness and oxidized with hydrochloric acid and potassium chlorate in a flask connected with a return-flow condenser.§ Tartaric acid and ammonia are then added and the arsenic precipitated with magnesia mixture as magnesium ammonium arsenate, as

* *Z. anal. Chem.*, **41**, 1 (1902).

† *Ibid.* (1893), **32**, p. 45.

‡ *Chem. Ztg.* (1894), **18**, p. 1900.

§ So that no arsenic trichloride will be lost by volatilization.

described on p. 206. After standing twelve hours, the precipitate is filtered off, washed with $2\frac{1}{2}$ per cent. ammonia, and, in order to remove a little magnesia, the precipitate is dissolved in hydrochloric acid and reprecipitated by the addition of ammonia. After standing another twelve hours, the precipitate is filtered off and again washed with $2\frac{1}{2}$ per cent. ammonia.

This precipitate can be converted into magnesium pyroarsenate and weighed in this form as described on p. 207. This transformation is somewhat tiresome, however, so that Hampe prefers to dissolve the precipitate in hydrochloric acid once more, to precipitate the arsenic by means of hydrogen sulphide, and then to determine the magnesium in the evaporated filtrate as magnesium pyrophosphate according to p. 66 or p. 67. From the weight of the latter the amount of arsenic can be computed as follows:

$$\text{Mg}_2\text{P}_2\text{O}_7 : 2\text{As} = p : x$$

$$x = \frac{2\text{As}}{\text{Mg}_2\text{P}_2\text{O}_7} \cdot p$$

or

$$x = 0.6731 \cdot p \text{ gm. arsenic.}$$

Separation of Antimony from Arsenic and Tin.

(a) *Method of Rose.*

If the metals are present in solution, they are precipitated as sulphides with hydrogen sulphide, heated with fuming nitric acid in a large covered beaker until the sulphur is completely oxidized, washed into a porcelain dish, and the excess of acid removed by evaporation on the water-bath. The almost-dry residue is treated with concentrated sodium hydroxide solution and the contents of the dish are transferred to a silver crucible, after which a little solid sodium hydroxide is added and the contents of the crucible dried in an air-bath. It is then fused* and kept liquid for about twenty minutes by heating over a Teclu burner. After cooling, the melt is disintegrated with water, one-third as much alcohol (sp. gr. 0.833) is added in order to completely precipitate the sodium metantimonate, and after standing twelve hours the

* The silver crucible is placed in a larger porcelain one so as to avoid contact with the flame.

precipitate is filtered and subjected to the treatment described on p. 251. The filtrate containing all the arsenic and tin is acidified with hydrochloric acid, whereby stannic arsenate is precipitated. Without filtering, hydrogen sulphide is conducted into the liquid, the precipitated sulphides of tin and arsenic are filtered off, oxidized with hydrochloric acid and potassium chlorate, and the arsenic separated from the tin as described on p. 255.

(b) *Method of Hampe.*

The moist sulphides are oxidized as described on p. 255, b, and the arsenic determined in the same way.

In the combined filtrates from the magnesium ammonium arsenate the antimony and tin are precipitated by hydrogen sulphide, after making the solution acid. These are separated either according to the method of Clarke (p. 248) or that of Rose (p. 250).

SUPPLEMENT TO THE HYDROGEN SULPHIDE GROUP.

GOLD, PLATINUM, SELENIUM, TELLURIUM, VANADIUM,
MOLYBDENUM, TUNGSTEN.

GOLD, Au. At. Wt. 197.2.

Gold is always determined as the metal itself. We have three cases to distinguish:

1. The gold is present in solution.
2. The gold is alloyed with copper and silver.
3. The gold is present in an ore.

i. Gold is Present in Solution.

In almost all cases gold is deposited as metallic gold from its solutions and weighed after filtering and washing.

For the deposition of gold the following reducing agents are to be considered: ferrous sulphate, oxalic acid, formaldehyde, and hydrogen peroxide. If the gold is to be precipitated by means of either *ferrous sulphate* or *oxalic acid*, there must be no free nitric acid present in the solution. If some is present, it must be removed by repeated evaporation with concentrated hydrochloric acid and the solution then diluted with water. To this

dilute solution a large excess of clear ferrous sulphate solution is added, the beaker is covered and its contents are heated for several hours on the water-bath. The precipitate is then filtered off, washed first with water containing hydrochloric acid until the iron is completely removed, and then with pure water. The precipitate is dried, transferred as completely as possible to a porcelain crucible, the ash of the filter added, and the gold is ignited and weighed. In this way gold can be separated from almost all metals, even platinum, but not from silver. If silver is present, which is of course never the case in a dilute hydrochloric acid solution, it is first removed by the addition of hydrochloric acid, the precipitated silver chloride filtered off, and the filtrate treated as above described.

For the precipitation of gold by means of *oxalic acid*, the slightly acid solution is diluted with water, oxalic acid or ammonium oxalate is added with a little sulphuric acid, and the covered beaker is allowed to stand forty-eight hours in a warm place.

The yellow scales of the deposited gold are filtered off and washed, as above described, with hydrochloric acid and then with water. It is then ignited and weighed.

*Deposition of Gold by Means of Hydrogen Peroxide (L. Vanino and L. Seeman).**

If a gold solution is treated with potassium or sodium hydroxide solution and then with formaldehyde, or, better still, hydrogen peroxide, the gold is soon precipitated quantitatively, even in the cold. By boiling, the finely-divided gold collects together and assumes a reddish-brown color. The reaction takes place according to the following equation:

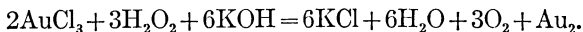

If the gold is deposited by this method from very dilute solutions it is obtained in such a finely-divided condition that it passes through the filter. If, however, the solution is boiled until the excess of hydrogen peroxide is completely destroyed, and it is then acidified with hydrochloric acid, the gold can be readily filtered. Gold can be separated from platinum by this method.

* Berichte (1899), 32, p. 1968.

2. The Gold is Alloyed with Copper and Silver.

When gold is present in alloys it is most rapidly and most accurately determined in the dry way. The principle of the method is very simple.

If a gold-silver alloy is melted in the air with lead upon a "cupel" (a very porous vessel made of bone-ash)* the lead and copper are oxidized, the oxides fuse and are absorbed by the cupel, while all the gold and silver are left behind in the form of a metallic button, whose weight is obtained. The silver is afterwards separated from the gold by the action of nitric acid which dissolves the silver but leaves the gold behind. If the weight of the gold that is left undissolved is deducted from the weight of the gold-silver button the weight of the silver is obtained.

In order to obtain accurate results a number of precautions must be taken. By the cupellation of the alloy some noble metal is always lost and the amount lost increases in proportion to the amount of lead used and the higher the temperature. Furthermore, small amounts of the noble metal are absorbed by the cupel and this amount is greater the smaller the amount of lead used. This second loss amounts to much less than the former one occasioned by the use of too much lead. *Consequently, in every gold cupellation an unnecessary excess of lead must be avoided.*

Experience has shown that the richer a gold-silver alloy is in base metal the more lead is necessary for the cupellation. Furthermore, in the separation of gold from silver by means of nitric acid it is necessary to remember that the separation is only quantitative when the alloy consists of three or more parts of silver to one part of gold. If less than three parts of silver are originally present for one part of gold, it is necessary to add pure silver until this proportion is reached. This operation is known as *quartation* or *inquartation*. The separation of the silver from the gold by means of nitric acid is spoken of as *parting*. If a gold-silver alloy, in the form of foil, which consists of three parts of silver to one of gold, is treated with nitric acid, the latter metal remains behind as a brownish scale; if more silver is present, it is left as a fine powder, unless the acid is made extremely dilute.

* According to R. Grund, Oesterr. Z. Berg-Hüttenw., 57, 681, magnesite is better than bone-ash.

From what has been said, it is clear that accurate results can be obtained only when the correct amount of lead is present in the alloy that is cupelled, and when the gold and silver are present in the proper proportion; i.e., it is necessary to know the approxi-

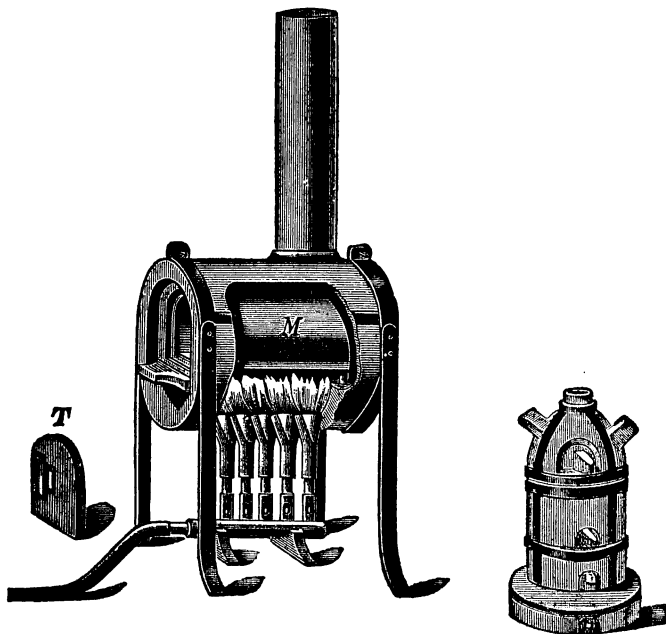

FIG. 49.

mate composition of the alloy before an accurate determination can be made. This is determined by

The Preliminary Assay.

For this purpose the muffle shown in Fig. 49 is heated to a cherry-red heat, a cupel weighing from 6 to 7 gms.* is placed in the back part of it, the muffle door is closed, and the cupel heated until it has acquired the same color as the muffle. After this 5 gms. of lead are placed upon the cupel, the muffle is closed until

* A good cupel will absorb its own weight of litharge. During the cupellation about one-tenth of the litharge formed is lost by volatilization, so that the weight of litharge absorbed by the cupel is practically that of the original lead button. Fig. 50 represents a cupel, together with its cross-section.



FIG. 50.

the lead is melted and then 0.25 gm. of the accurately-weighed alloy is enveloped in a small piece of lead-foil, placed in the molten lead (with the help of a pair of tongs), and the muffle closed until the alloy has melted and shows a bright upper surface. With the help of an iron hook the cupel is now carefully advanced to about the middle of the muffle and the door should be left open so that there is a ready access of air into the muffle.

After about twenty minutes the lead will be all absorbed, which is shown by the "blick." * The hot cupel is then removed from the muffle and after cooling, the color of the button is observed.

(a) *If the button is greenish yellow or darker*, it contains less than three parts of silver to one part of gold, in which case from four to six parts of "fine silver" are added (the proper amount can be usually told by the practised eye) and the button is cupelled in a new cupel with 1 gm. of lead. The button now obtained is treated with nitric acid and the residual gold weighed.

(b) *If the button is pure white*, then three or more parts of silver are present to one part of gold. In this case it is immediately "parted" and the residual gold weighed.

After the approximate amount of gold present has been ascertained, † the analysis proper is made, using the amount of lead as indicated in the following table:

LEAD TABLE.	
Amount of Gold Present in the Alloy.	Amount of Lead Necessary for the Cupellation of 0.25 gm. of Alloy.
1000 thousandths.....	0.25 gm.
900 "	2.50 gms.
800 "	4.00 "
700 "	5.50 "
600 "	6.00 "
500 "	6.50 "
400 or less "	8.50 "

* The blick is the brightening of the metal which appears when the outer layer of lead oxide that is constantly becoming thinner finally bursts and the bright noble metal shines through. Just before the blick there is a distinct iridescence, so that the point can never be mistaken.

† In assay laboratories the approximate gold contents of the alloy is determined by its streak. A fine-grained piece of silicate is blackened with charcoal. The alloy to be tested is rubbed upon it and the color produced com-

The Final Assay.

For the definite determination of the gold and silver, two portions weighing exactly 0.25 gm. are taken; the one to serve for the silver determination and the other for the gold. The former is cupelled with the correct amount of lead and the weight of the gold-silver button is determined.

If the original alloy was very white, it contains more than 500 thousandths fine of silver.

If the alloy was greenish yellow, it contains 550–750 thousandths of noble metal, and silver is present to a considerable extent.

If, however, the alloy was a beautiful yellow or reddish yellow, it contains more than 700 thousandths of noble metal and the gold predominates.

If, therefore, the alloy was white, once again as much pure silver is weighed out as the amount of gold found to be present by the preliminary assay (inquartated with one part of silver), and this mixture is cupelled with the same amount of lead as the first portion.

If the original alloy was greenish yellow, it is inquartated* with two parts of silver; if it was distinctly yellow or reddish yellow it is inquartated with $2\frac{1}{2}$ parts of silver.

Treatment of the Quartered Gold-Silver Button.

The gold-silver button is removed from the cupel with the "button tongs," cleaned with a stiff brush ("button brush"), and hammered upon an anvil to a round disk about 1 mm. thick (Fig. 51, *a*). This is heated upon a fresh cupel and quickly cooled by placing it upon a piece of brass foil and rolling it between two steel rollers to a long strip (Fig. 51, *b*); it is again heated and rolled † up as shown in Fig. 51, *c*. This little roll is placed in a

pared with that obtained from alloys containing known amounts of gold. Afterwards these streaks are tested with dilute aqua regia; alloys containing the same amounts of gold are attacked equally readily.

* Cf. p. 259.

† By hammering the gold-silver alloy, the metal becomes so brittle that it cannot be converted to a smooth-margined roll, and on the subsequent treatment with nitric acid, little pieces would probably drop off. By again heating the metal and then quickly cooling, it regains its original softness.

little flask (Fig. 52, *I*), covered with 30–40 c.c. of nitric acid (sp. gr. 1.188) free from chloride, heated to boiling and kept so for ten minutes. The acid is then poured off and replaced by the

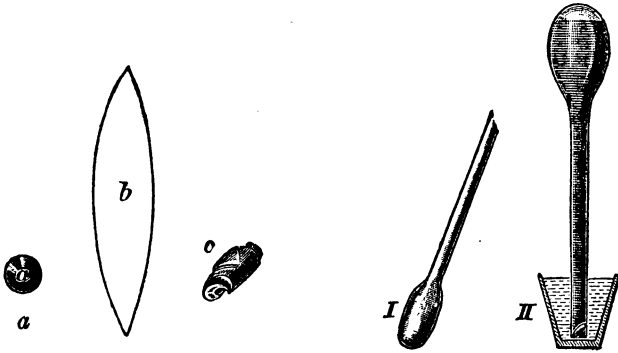

FIG. 51.

FIG. 52.

same amount of stronger acid (sp. gr. 1.295) and the above treatment repeated. After this acid is poured off, the button is washed by decanting three times with distilled water. The flask is filled with water, covered with an annealing cup (or lacking this an ordinary porcelain crucible may be used), and is then quickly inverted (Fig. 52, *II*), when the gold will pass into the cup. The flask is removed by first raising its mouth to the level of the water in the crucible and then sliding it off at right angles and skilfully turning the flask right side up. The water is poured off from the gold and the crucible is placed in the back part of the muffle for a short time, whereby the gold is dried and is changed from its former brown and soft condition into a harder, beautiful yellow substance. After cooling, it is weighed. By subtracting the weight of the gold from the weight of the gold and silver together, the amount of silver is obtained.

Determination of Gold in Ores.

Principle.—The very finely ground and sifted ore is mixed in a No. 9 French crucible with lead oxide, charcoal, and some suitable slag-forming material. The charcoal reduces a part of the lead oxide to metal which alloys with the noble metal and sinks to the bottom in the form of a button, while the foreign sub-

stances should pass into the slag. After cooling, the crucible is broken, the slag is hammered off, the lead button cupelled and the silver-gold button parted in the same way as before. The noble metal should be extracted with as little lead as possible, for with an unnecessarily large amount of lead some gold is lost during the cupellation.

The amount of lead reduced from the litharge depends largely upon the nature of the ore. Sulphide ores act strongly reducing, as is shown by the following equations:

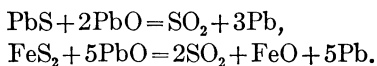

In such cases less charcoal (or in some cases none at all) should be added than would be otherwise necessary to produce the right amount of lead, or in case considerable sulphide is present, it is sometimes necessary to neutralize its action by the addition of oxidizing agents.

Reducing ores are recognized by their color: they are gray, bluish-black, or yellow (pyrite, etc.). Reddish-brown ores (Fe_2O_3) usually act oxidizing:

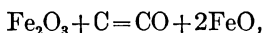

in which case more charcoal must be added to the charge.

The best results are obtained when the lead button weighs about 18 gms. when obtained from 30 gms. of ore.* In order that such a button may be obtained, it is usually necessary to make a preliminary assay of the ore. But above all, it is necessary that the purity of the reagents used should be tested.

Testing the Reagents.

The ordinary reagents necessary for a gold assay are;

1. Litharge (PbO).

Litharge, the most important reagent, is a basic flux, for it forms with the silicic acid of the ore a readily fusible silicate;

* This amount is usually sufficient; with very rich gold ores 10-15 gms. is enough, while with very poor ores as much as 120 gms. may be used to advantage. Cf. Ricketts and Miller, *Notes on Assaying*, New York, 1897.

at the same time, however, it is a desulphurizing agent, as is shown by the above reaction.

The litharge used must be dry and free from minium, for the latter oxidizes silver, carrying it into the slag, so that low results would be obtained in the silver determination. The litharge should be free from silver (which is almost never the case), or its silver contents must be known; this is determined once for all by the following experiment:

Litharge.....	120 gms.
Sodium bicarbonate (NaHCO_3).....	60 "
Argols (crude $\text{KHC}_4\text{H}_4\text{O}_6$).....	2 "

are mixed thoroughly upon a sheet of glazed paper and the mixture placed in a No. 9 French crucible and covered with a layer of finely-powdered, dry common salt. The covered crucible is placed in a glowing coke-oven.

As soon as the contents of the crucible have reached the state of quiet fusion, the crucible is removed from the fire, its walls are gently tapped by the tongs, and it is lightly tapped upon its bottom in order to knock down any small particles of lead adhering to the sides and to make all of the free metal collect together on the bottom in the form of a button.

After cooling the crucible is broken, the slag removed from the lead button by hammering it upon an anvil, and it is cupelled upon a cupel weighing only a few grams more than the button itself. The resulting silver button is weighed. The amount of silver obtained must be deducted whenever the corresponding amount of litharge is used in an assay.

2. Sodium Bicarbonate (NaHCO_3).

3. Anhydrous Borax ($\text{Na}_2\text{B}_4\text{O}_7$).

2 and 3 require no testing.

4. Charcoal.

The reducing power is determined as follows:

Litharge.....	60 gms.
Sodium bicarbonate.....	15 "
Charcoal.....	1 gm.

are mixed, as in the testing of litharge, in a French crucible No. 9 with a cover of ordinary common salt and fused. After cooling, the weight of the lead button obtained is determined and this expresses in terms of lead the reducing power of the charcoal.

1 gm. of charcoal should reduce about 30 gms. lead.

5. Nitre (KNO_3)

serves as an oxidizing agent. Its oxidizing power expressed in terms of lead is determined:

Nitre	3 gms.
Litharge	60 "
Charcoal	1 gm.
Sodium bicarbonate	15 gms.

are mixed and fused as before and the weight of the lead button determined. If under (4) it was found that 1 gm. charcoal would reduce P gm. lead, and if p gm. of lead were obtained in this experiment, then the difference $P-p$ shows the amount of lead that was oxidized by 3 gms. nitre, or the oxidizing power of the nitre.

1 gm. nitre oxidizes about 4 gms. lead.

6. Common Salt.

Ordinary table salt is heated in a large Hessian crucible until it melts, and the contents of the crucible are poured into a shallow iron mould with a raised edge. The solidified crust is finely powdered and preserved in a stoppered flask.

After the reagents have all been tested the next step is the

Preliminary Assay.

Five grams of the finely-powdered and sifted ore are weighed out and mixed with:

Litharge	80 gms.
Sodium bicarbonate	20 "
Borax	5 "

placed in a crucible and covered with a layer of common salt. After fusing, cooling, and hammering off the slag, the lead button obtained is weighed.

Since in an ordinary assay we start with 30 gms. of ore, the

weight of the lead button now obtained multiplied by 6 will give the weight of the button from the real assay. We will distinguish four cases:

(1) *The lead button weighs 3 gms.*

Consequently the button obtained from 30 gms. of ore would weigh 18 gms. In this case the ore is assayed with the following proportions of flux:

Ore	30 gms.
Litharge	80 "
Sodium bicarbonate	20 "
Borax	5 "

(2) *The lead button weighs less than 3 gms.*

Evidently the ore acts reducingly, but not enough so to yield a button weighing 18 gms. when 30 gms. of ore are used; it is, therefore, necessary to add charcoal to the flux.

Example.—Let us assume that the lead button obtained by the preliminary assay weighed 1 gm., then the button obtained from 30 gms. of ore would weigh 6 gms. In order to obtain a button weighing 18 gms. it is necessary to add enough charcoal to supply 12 gms. of lead. If 1 gm. of charcoal was found to reduce 30 gms. of lead, then it is necessary to add $12 \div 30$ gms. = 0.4 gms. of charcoal.

(3) *The lead button weighs more than 3 gms.*

In this case the ore has a strong reducing power, and to obtain the lead button of the right weight it is necessary to add some nitre.

Example.—Suppose the button to weigh 6 gms.; this would mean a 36-gm. button when 30 gms. of ore were used; i.e. 18 gms. too much lead would be produced. We must add, therefore, enough nitre to oxidize this 18 gms. of lead. If the oxidizing power of 1 gm. of nitre was found to be 4 gms. of lead, then $18 \div 4 = 4.5$ gms. of nitre must be added to the flux.

Remark.—Ores which have a very strong reducing power would frequently require the addition of enough nitre to cause the contents of the crucible to boil over. In such a case, about 40–50 gms. are placed in a "roasting-dish" and roasted in a muffle, and from this roasted ore the portions are taken for the preliminary and

final assays. The results, however, must be expressed in terms of the unroasted ore.

(4) *There is no lead button formed.*

The ore is either neutral or possesses an oxidizing action. The assay is repeated, using 1 gm. of charcoal, and from the results now obtained the final assay is based.

Final Assay.

For the final assay from 30–120 gms. of ore * are taken (according to the amount of gold present) and the corresponding amount of sodium bicarbonate is added. The amount of litharge also varies with the amount of ore, and in some cases as much as 240 gms. are necessary, although as a rule 80 gms. are sufficient. Otherwise the procedure is exactly the same as in the preliminary assay. The lead button is cupelled and the weighed silver-gold button is parted as described on p. 263.

PLATINUM, Pt. At. Wt. 195.0.

Platinum is best determined as metallic platinum.

The following three cases will be considered:

1. The platinum is present in a hydrochloric acid solution either alone or together with other metals, but other platinum metals are absent.
2. The platinum is present alloyed with gold and silver.
3. The platinum is alloyed with small amounts of the platinum metals together with small amounts of base metals.

i. The Platinum is Present in Hydrochloric Acid Solution Either Alone or Together with Other Metals.

The platinum is either precipitated from the solution as ammonium chloroplatinate, $(\text{NH}_4)_2\text{PtCl}_6$, which is decomposed by ignition and the residual platinum weighed; or the platinum is precipitated as metal by the addition of reducing agents to the solution; or finally the platinum is precipitated as sulphide by conducting hydrogen sulphide into the hot solution and changed to platinum by ignition. The two former methods serve to separate platinum

* Usually "assay tons" are used as units in weighing out the ore, and the weights are calibrated in terms of this unit instead of the gram. An "assay ton" contains the same number of milligrams that there are ounces troy to a ton, so that by weighing the button obtained in milligrams, it is at once known how many ounces per ton the ore carries.

from most other metals, while the latter serves to separate platinum only from the metals of the alkali, alkaline earth, and ammonium sulphide groups, and not from members of the hydrogen sulphide group.

(a) *Precipitation of Platinum as Ammonium Chloroplatinate.*

The solution, concentrated as much as possible, is nearly neutralized with ammonia, an excess of ammonium chloride and considerable alcohol are added, and the mixture allowed to stand twelve hours under a glass bell-jar. It is then filtered through an asbestos filter tube 10-15 cm. long, washed with 80 per cent. alcohol until a few drops of the filtrate leave no residue on being evaporated to dryness on a platinum foil. The precipitate is dried by conducting a stream of air warmed to about 90° C. through the tube. After cooling the tube is weighed, a plug of ignited asbestos* is introduced, and the tube is again weighed; in this way the weight of the asbestos plug is found. A stream of dry hydrogen is now conducted through the tube, and the latter is heated at as low a temperature as possible until no more hydrochloric acid is evolved and all the ammonium chloride has been driven off, after which the tube is cooled in a desiccator and weighed.

Instead of filtering the precipitate upon asbestos an unweighed paper-filter may be used. The moist precipitate is placed together with the filter in a large porcelain crucible so that the apex of the filter-paper points upward, and the covered crucible is then ignited. This ignition must be performed with great care, as otherwise there can be a considerable loss during the process. At first the precipitate is dried by gently warming the covered crucible, and when the odor of alcohol has disappeared, the temperature is raised very slowly until the crucible is at a strong red heat. During the whole operation there must be no visible escape of vapors from the crucible. The decomposition is complete when there is no longer a penetrating odor arising from the covered crucible. When this point is reached, the cover (whose under side will be covered with carbon) is removed for the first time and leaned against the crucible and the contents of the latter

* Ammonium chloroplatinate decrepitates during the heating. To prevent loss of substance it is heated between two asbestos plugs.

are ignited with free access of air until the carbon from the filter-paper is completely burned. Often a slight deposit of platinum* will be found in the upper part of the crucible and upon the cover, so that the latter must always be weighed with the crucible.

Remark.—If it seems likely that the precipitate of ammonium chloroplatinate is contaminated with other substances (e.g. sodium chloride, etc.) the precipitate can be dissolved in water after it has been washed with alcohol and dried. The platinum may then be determined, as described on p. 50, by precipitating with mercury, washing with dilute hydrochloric acid and then with water, and finally weighing.

The results obtained by this method are satisfactory but somewhat lower than the true values; the following process is more accurate:

(b) *Precipitation of Platinum by Reducing Agents.*

The solution is freed from any excess of acid by evaporation, placed in an Erlenmeyer flask into the neck of which is ground to fit a return-flow condenser. The solution is neutralized with ammonia, an excess of formic acid and a little ammonium acetate are added, and the contents of the flask after being diluted to a volume of 200 c.c. are heated to about 80° C. on the water-bath until the evolution of carbon dioxide has nearly ceased. The flask is now connected with the return-flow condenser, and its contents boiled for twenty-four hours. The precipitated metal is filtered off, washed with dilute hydrochloric acid, then with water, dried, ignited, and weighed.

2. The Platinum is Alloyed with Gold and Silver.

An alloy is seldom found which contains only the above three noble metals; usually copper is also present. The first step, then, is to separate the noble metals from the others by cupellation with

* By means of the dry distillation of the filter, carbon monoxide is formed, and by the decomposition of the ammonium chloroplatinate chlorine is set free. These two gases act upon the metallic platinum and form volatile compounds (PtCl_2CO , $\text{PtCl}_2\cdot 2\text{CO}$, and $2\text{PtCl}_2\cdot 3\text{CO}$), which, however, are later decomposed by the aqueous vapor. This causes the deposit of platinum in the upper part of the crucible. In order to avoid loss, a large crucible should be used.

lead as described on p. 259, after which the hammered and rolled button is treated with pure concentrated sulphuric acid. [Nitric acid cannot be used, for some platinum would be dissolved with the silver.] After boiling for ten minutes, the silver will be completely dissolved, provided at least two parts of silver are present for each part of platinum, which is usually the case. If more platinum is probably present than corresponds to the above ratio, pure silver should be added, and the mixture cupelled once more with 1 gm. of lead.

After the alloy has been boiled for ten minutes with sulphuric acid it is allowed to cool, filtered, and the treatment with sulphuric acid repeated once again. The metal remaining behind (in the form of a roll or as a powder) is washed three times by decantation with water, ignited, and weighed as described under gold. This gives the weight of the gold and the platinum together, and by subtracting this amount from the original weight of the noble metals obtained after cupellation, the weight of the silver is obtained.

Separation of Gold from Platinum.

Principle.—If an alloy of gold and platinum is treated with nitric acid, neither metal is attacked. If, however, the alloy contains three parts of silver to one of gold and platinum taken together, and the alloy is treated at first with acid of sp. gr. 1.16 and then with acid of sp. gr. 1.28, the platinum gradually goes into solution with the silver.

Procedure.—The gold-platinum alloy is cupelled with three times its weight of pure silver and 1 gm. of lead, the resulting button is hammered and rolled, after which it is treated with nitric acid (of the strength stated above), and the residual metal weighed. It is again cupelled with three parts of pure silver, and the same process repeated. This is continued until a constant weight is finally obtained for the residual gold; the third operation usually accomplishes this.

Instead of effecting the separation of the gold from the platinum in this way, the two metals may be dissolved in aqua regia, and the gold precipitated by means of ferrous sulphate, as described on p. 257. This is a good method.

According to Vanino, and Seemann,* the separation is effected much more quickly by precipitating the gold from an alkaline solution by means of hydrogen peroxide. In order to determine the platinum, it is precipitated from the boiling acid filtrate by hydrogen sulphide and weighed as metal after ignition in a porcelain crucible.

Analysis of Commercial Platinum, according to Deville and Stas.

Five grams of the platinum alloy † are heated for five hours at a temperature of about 1000° C. with ten times as much lead in a crucible of purified gas-carbon; this crucible is embedded in one of clay which is filled with charcoal. After cooling, the lead button is treated with very dilute nitric acid until there is no longer any gas evolved.

In this way a **solution, A**, is obtained, containing about 98.4 per cent. of the lead used, all the palladium and copper, and small amounts of platinum, rhodium, and iron, and a **residue, B**, consisting of a black metallic powder, which is filtered off, and will contain the remainder of the platinum and rhodium with all of the iridium and ruthenium.

1. Treatment of the Nitric Acid Solution A.

The lead is precipitated by the addition of slightly more than the theoretical amount of sulphuric acid, and filtered. If the lead sulphate is pure white, it is washed with dilute sulphuric acid. If it is not absolutely white, it is washed with a solution of ammonium carbonate until it becomes so; small amounts of lead are dissolved by this operation. This last wash liquid, therefore, is concentrated, to precipitate the lead carbonate, filtered, and after making acid with hydrochloric acid, added to the main filtrate.

The solution is evaporated to about 100 c.c., and when cold is poured into a saturated solution of ammonium chloride. The mixture is heated to boiling and allowed to cool again. The ammonium chloroplatinate is filtered off and washed with a saturated solution of ammonium chloride; in this way, the greater part of the platinum is obtained.

* Berichte 1899, p. 1971.

† All commercial platinum contains other platinum metals, especially iridium.

The filtrate from the platinum precipitate is boiled with formic acid and ammonium acetate as described on p. 270, *b*. In this case the remainder of the platinum, the palladium, and the rhodium will be precipitated. These metals are filtered off, and the copper and iron are determined in the filtrate in the usual way. The formic acid precipitate (consisting of a black metallic powder) is dried and fused with potassium bisulphate in a porcelain crucible. The melt is treated with water, the solution decanted from the unattacked platinum and washed alternately with ammonium carbonate and nitric acid (to remove traces of lead sulphate), then with dilute hydrofluoric acid, and finally with water; it is then dried and weighed. The filtrate from the platinum contains palladium and rhodium. The former is precipitated by the addition of mercuric cyanide, and boiling until the odor of hydrocyanic acid has disappeared. The voluminous, yellowish-white precipitate of palladous cyanide is washed first by decantation, then upon the filter, dried, and ignited at first cautiously and then strongly over the blast until the paracyanide is completely destroyed; finally heating in a current of hydrogen (as in the case of copper sulphide, p. 183) in order to reduce any palladium that has been oxidized by the previous treatment. As soon as the flame is removed, the supply of hydrogen is at once cut off in order to prevent its being absorbed by the metal. The palladium is weighed after cooling.

The rhodium is precipitated from the filtrate by means of formic acid, as before, and the deposited metal is dried, ignited in a stream of hydrogen, allowed to cool in the gas, and then weighed.

2. *Treatment of the Residue B.*

The washed residue is warmed with dilute aqua regia (in this case 2 vol. nitric acid, 8 vol. hydrochloric acid, and 90 vol. water), and in this way **solution C** is obtained, which contains the rest of the lead, platinum, and rhodium, and **residue D**, consisting of lamellæ of iridium and ruthenium.

3. *Treatment of the Solution C.*

After evaporating to a small volume, the lead is removed by sulphuric acid, the solution again evaporated, taken up in hydrochloric acid, and the platinum present is precipitated by pouring

into a cold saturated solution of ammonium chloride exactly as described under 1, p. 272. The platinum precipitate contains a little rhodium, and after washing it with a saturated solution of ammonium chloride, it is placed at one side for the time being.

The filtrate, together with the wash water, is evaporated until more platinum and rhodium separate out on cooling, and this precipitate is filtered off and washed as before.

Both filters, together with the precipitates, are now placed in a small, weighed porcelain dish, dried, and reduced at as low a temperature as possible, in a stream of illuminating gas, and heated somewhat in a muffle so as to remove the carbon from the filter. The metal thus obtained (platinum + rhodium) is weighed. For the separation of the rhodium from the platinum, the spongy metal is heated in the same dish with potassium bisulphate, gradually raising the temperature until a dull-red heat is obtained. After cooling, the melt is extracted with water, the unattacked platinum (it may still contain small amounts of rhodium) is filtered off, washed, and again fused with potassium bisulphate. This operation is repeated until the rhodium is completely extracted, which is known by the melt showing no yellow color after ten minutes.

The platinum is washed, ignited, and weighed as described under 1.

The combined filtrates from the platinum contain rhodium and still a little platinum. Ammonia, acetic and formic acids, therefore, are added once more, and the solution boiled for a long time. The precipitated metal is filtered off, ignited, weighed, afterward fused at a distinct red heat with potassium bisulphate, and the cold melt extracted with water. If a residue remains after this treatment, it is filtered off, weighed, and treated with dilute aqua regia. If it dissolves, it is platinum; if it does not, it is rhodium.

The filtrate from the ammonium chloroplatinate, which contained some rhodium, is diluted, formic acid and ammonium acetate are added, and it is gently boiled for two or three days in an Erlenmeyer flask connected with a return-flow condenser. The liquid evaporates somewhat in spite of the condenser, and the evaporated part is replaced from time to time with a dilute solution of ammonium formate. In this way small amounts of platinum and rhodium are precipitated, which are filtered off and separated by

fusion with potassium bisulphate as before. In the filtrate there are likely to be present traces of platinum, rhodium, and iron.

The iron is first removed by the addition of chlorine water and afterward ammonia; the ferric hydroxide is filtered off, ignited, and weighed. In order to remove the last traces of platinum and rhodium, this last filtrate is evaporated to dryness, the residue heated with nitric acid in order to remove the ammonium chloride completely, and then boiled for a long time with formic acid and ammonium acetate. The traces of metal thus obtained are washed with hydrofluoric acid and added to the main portion of platinum and rhodium.

4. *Treatment of the Residue D.*

The undissolved, gray lamellæ consisting of iridium, ruthenium, and small amounts of iron obtained by the action of dilute aqua regia, are filtered off, dried, ignited in an atmosphere of hydrogen or illuminating gas, and weighed.

The weighed metal is then fused in a pure gold crucible with potassium nitrate and carbonate. For this purpose, a previously melted mixture of 3 gms. potassium nitrate and 10 gms. potassium carbonate is placed in the crucible, the metal added, and the mixture heated for two hours at a dull-red temperature. In this way the ruthenium is changed completely into water-soluble potassium ruthenate, K_2RuO_4 , and the iridium is oxidized to Ir_2O_3 ; the latter forms, to some extent, a soluble compound with the alkali.

The melt is treated with water, and the solution, together with the suspended Ir_2O_3 ,* is poured into a stoppered cylinder, the precipitate allowed to settle, and the clear liquid decanted off into a retort.

The residue remaining in the cylinder is covered repeatedly with a dilute solution of sodium hypochlorite and sodium carbonate, until the yellow color is completely removed. The decanted liquid is added to the main solution in the retort. This solution contains all the ruthenium and a part of the iridium. It is saturated with chlorine in the cold, distilled, and the distillate received in a mixture of alcohol (distilled over potassium) and pure hydrochloric acid.

* Cf. W. Palmaer, *Z. anorg. Chem.* 10, 332 (1896).

After the distillation is complete, the alcoholic distillate is evaporated to dryness and the ruthenium chloride thus obtained is reduced to metal by heating in a stream of hydrogen. After weighing, the purity of the ruthenium is tested. It must dissolve completely in a concentrated solution of sodium hypochlorite.

The liquid remaining in the retort is evaporated to a small volume, the insoluble residue remaining in the cylinder (that was washed with sodium hypochlorite and sodium carbonate) is added, and the mixture boiled with caustic soda solution, with the addition of a little alcohol, until all of the iridium is precipitated.

The dark-blue precipitate, consisting of iridium oxide and small amounts of ferric hydroxide, is filtered off, washed, and strongly ignited. The ferric oxide contained in it is then extracted with hydrochloric acid containing some ammonium iodide, and the residual iridium oxide is washed successively with water, chlorine water, and hydrofluoric acid in order to remove gold that came from the crucible and silicic acid from the caustic soda. It is then ignited in hydrogen and the iridium weighed.

The iron present in the hydrochloric acid extract is precipitated as ferric hydroxide, ignited, and weighed. Its purity is tested by heating in a stream of hydrogen and hydrochloric acid, to see if it can be completely changed to ferrous chloride and volatilized as such.

F. Mylius and F. Förster* have recommended that platinum be tested for small amounts of impurity by taking three separate portions each weighing 10 gms. The first portion is tested for palladium, iridium, and ruthenium according to the lead procedure just described of Deville and Stas. The second portion serves for the iron determination; the metal is dissolved in aqua regia, the platinum metals precipitated by formic acid, and the iron determined in the filtrate. In the third portion, rhodium, silver, copper, and lead are determined by volatilizing the platinum as PtCl_2CO at 238°C . (temperature of boiling quinolin) in a stream of carbon monoxide and chlorine, and determining the above substances in the residue.

Remark.—The determination of the iron in a separate portion is to be recommended, for in the lead procedure some iron is always obtained from the carbon crucible.

* Berichte 1892, p. 665.

SELENIUM, Se. At. Wt. 79.2.

Selenium is usually determined as the element itself.

Three cases are to be considered:

- I. The selenium is present as alkali selenite or as selenious acid.
- II. The selenium is present as alkali selenate or as selenic acid.
- III. The selenium is present as potassium selenocyanide.

I. *The selenium is present as selenite or as free selenious acid.*—The solution is acidified with hydrochloric acid, saturated with sulphur dioxide gas, boiled, filtered through a Gooch crucible, and washed first with water, then with alcohol. The residue is dried at 105° C. and weighed.

Remark.—The precipitation of selenium by sulphur dioxide is always quantitative whether the solution is concentrated or dilute, whether it contains much or little free acid. This latter fact is of importance in the separation of selenium from tellurium, for the latter element is not precipitated by sulphur dioxide when considerable hydrochloric acid is present (cf. p. 279).

Phosphorous acid does not precipitate selenium from cold, dilute, strongly acid solutions; this fact is made use of in the separation of selenium from mercury (cf. p. 281).

II. *The selenium is present as alkali selenate or as free selenic acid.*—As selenium in the form of selenic acid is not precipitated by sulphur dioxide, phosphoric acid, or hydrogen sulphide, it must be first reduced to selenous acid by long-continued boiling with hydrochloric acid (cf. Vol. 1); the above procedure is then followed.

III. *The selenium is present as potassium selenocyanide.*—The solution, concentrated as much as possible, is treated with hydrochloric acid, boiled, allowed to settle, and the precipitate filtered through a Gooch crucible, dried at 105° C., and weighed.

Remark.—From very dilute solutions of potassium selenocyanide, selenium separates out only very slowly according to this method; it is therefore advisable to concentrate the solution as much as possible, but when this cannot be done, the boiling with hydrochloric acid should be continued for some time and the liquid allowed to stand before filtering.

In practice, selenium is obtained usually in none of the above forms, but as impure selenium (selenium sponge) or as selenide, and by the treatment of these substances one or the other of the above selenium compounds is obtained.

If the selenium or selenide is acted upon by concentrated nitric acid,* or aqua regia, all of it is dissolved in the form of selenous acid (not selenic acid). After evaporating the solution several times with hydrochloric acid in order to remove the excess of nitric acid, the selenium is precipitated by sulphur dioxide as described under 1.

If the finely powdered selenium or selenide is intimately mixed with two parts sodium carbonate and one part potassium nitrate, placed in a nickel crucible, covered with a layer of sodium carbonate and potassium nitrate and heated gradually until it fuses, all the selenium forms alkali selenate and on extracting the melt with water it goes into solution; in this way it is separated from most of the remaining oxides. The solution, however, often contains small amounts of lead. In order to remove the latter, the filtrate is treated with hydrogen sulphide, and again filtered; the solution is freed from hydrogen sulphide by boiling, strongly acidified with hydrochloric acid, boiled until no more chlorine is evolved and the selenium is precipitated by sulphur dioxide according to II.

Remarks.—The mixture must be heated very slowly, as otherwise some selenium is likely to be lost by volatilization.

Selenium and very many selenium compounds may be satisfactorily determined as follows: The dry, finely powdered sponge is fused at as low a temperature as possible in a current of hydrogen † with twelve times as much potassium cyanide. After the mass has fused quietly for about fifteen minutes it is allowed to cool in hydrogen. It is then extracted with water, the solution is heated to boiling, and analyzed according to III.

* Mercury cyanide is unacted upon by nitric acid, but is dissolved by aqua regia.

† A Rose crucible (Fig. 37, p. 185) is used, or a round-bottomed flask with a long neck made of difficultly fusible glass, from which the air is replaced by hydrogen. In the latter case the delivery-tube must be so wide that the neck of the flask is nearly filled with it.

It is necessary to boil the solution of potassium selenocyanide before acidifying it, for small amounts of potassium selenide (K_2Se) are almost always present, and on acidifying with hydrochloric acid this is decomposed with evolution of hydrogen selenide. On boiling, the potassium selenide is changed to potassium selenocyanide according to the equation:

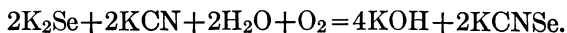

TELLURIUM, Te. At. Wt. 127.5.

Tellurium is usually determined as the element itself.

If sulphur dioxide is conducted into a hydrochloric acid solution containing tellurous acid, black tellurium is quantitatively precipitated, *provided the solution does not contain too much acid*. If tellurous acid is dissolved in 200 c.c. of hydrochloric acid, sp. gr. 1.175, no tellurium will be precipitated on passing sulphur dioxide into the cold solution. If, however, the solution is diluted with an equal volume of water and sulphur dioxide is passed into the boiling solution, all the tellurium will be precipitated. The precipitate is filtered off, washed with water until free from chlorides, then with alcohol, dried at $105^\circ C.$ and weighed. The oxidation of the tellurium during the drying is so slight that it can be disregarded.*

Separation of Selenium and Tellurium from the Metals of Groups III, IV, and V.

By conducting sulphur dioxide into the solution fairly acid with hydrochloric acid, the selenium and tellurium will be quantitatively precipitated while the other metals remain in solution.

* The presence of nitric acid prevents the complete precipitation of the tellurium by means of sulphur dioxide and similarly the presence of sulphuric acid is harmful. To remove nitric acid, sodium chloride is added and the solution evaporated to dryness repeatedly with hydrochloric acid. According to Brauner the addition of sodium chloride is absolutely necessary, as otherwise an appreciable amount of tellurium will be volatilized as chloride. A. Gutbier (Ber. **34**, 2724 (1901)) reports that all these difficulties are overcome by precipitating tellurium from a hot solution by means of hydrazine hydrate or hydrazine hydrochloride, but not the sulphate. See also P. Jannasch and M. Müller, Ber. **31**, 2393 (1898).

Separation of Selenium and Tellurium from the Metals of Group II.*(a) From Copper, Bismuth, and Cadmium.*

Sulphur dioxide is passed into the boiling solution, acid with hydrochloric acid, whereby all of the selenium and tellurium and usually some of the bismuth are precipitated. The precipitate after being washed is dissolved in nitric acid, the solution evaporated to dryness, taken up in concentrated hydrochloric acid, diluted with a little water and precipitated with hydrogen sulphide. The precipitate, consisting of the three sulphides, is washed and then treated with sodium sulphide solution whereby selenium and tellurium pass into solution while the bismuth remains behind as its brown sulphide and is filtered off.

The solution containing the selenium and tellurium is acidified with nitric acid, carefully evaporated to dryness and the residue boiled with 200 c.c. of hydrochloric acid, sp. gr. 1.175, until there is no longer any evolution of chlorine. The deposited sulphur is then filtered off through a Gooch crucible, and the filtrate saturated with sulphur dioxide gas; all the selenium is in this way precipitated. The latter is filtered off through a Gooch crucible and washed successively with a mixture of 90 vol. HCl (sp. gr. 1.175) and 10 vol. water, dilute hydrochloric acid, and finally absolute alcohol. The precipitate is dried at 105° C. and weighed. The filtrate is diluted with an equal volume of water and the tellurium precipitated by passing sulphur dioxide into the boiling solution. This precipitate is washed with water until free from chlorides, then with absolute alcohol, after which it is dried at 105° C. and weighed.

Remark.—The above method is suitable for the separation of selenium and tellurium from small amounts of bismuth, but does not effect the separation of selenium (and tellurium) from copper. In this case, more or less copper selenide is formed according to the conditions, and this compound is not decomposed quantitatively by sodium sulphide.* In this case, the method of B. Brauner and B. Kuzma† may be used.

* Cf. E. Keller, J. Am. Chem. Soc., 19, 771.

† Berichte, 1907, 3362.

The tellurium and selenium are precipitated in a pressure flask, by means of SO_2 , the precipitate, which is contaminated with copper, antimony and bismuth, is filtered (using a Gooch crucible) washed, dissolved in nitric acid, the solution evaporated to dryness and the residue taken up in caustic potash solution (1:5). The alkaline solution is placed in an Erlenmeyer flask upon a water-bath, and little by little 4–6 gm. of ammonium persulphate are added, whereby the potassium tellurite is oxidized to potassium tellurate and the selenite to selenate. When all the persulphate has been introduced, the solution is heated to boiling to decompose the excess of persulphate, then acidified with sulphuric acid and allowed to cool. Now, 100 c.c. of H_2S -water are added, the excess of the H_2S expelled by passing CO_2 through the solution, and the precipitated CuS (Bi_2S_3 , Sb_2S_3) filtered off, and treated as described on p. 235. The filtrate is boiled with hydrochloric acid to reduce the telluric acid to tellurous acid, and the solution is reduced by means of SO_2 and analyzed as described above.

The first filtrate from the impure Te and Se will contain the greater part of the Cu, Bi, etc.

(b) *From Antimony, Tin and Arsenic.*

If considerable antimony is present, tartaric acid is added to the solution, and the selenium and tellurium are then precipitated by boiling with sulphur dioxide.

According to Muthmann and Schröder* this method of separating tellurium from antimony is not quantitative; some antimony is always precipitated with the tellurium. A. Gutbier,† however, finds that a perfect separation can be accomplished by means of hydrazine hydrochloride (not the sulphate).

(c) *From Mercury.*

The mercury selenide, or telluride, is dissolved in aqua regia, chlorine water is added, and the solution is diluted largely with water. Phosphorous acid is added,‡ and after twenty-four hours standing,

* Z. anorg. Chem., **14**, 433 (1897).

† Z. anorg. Chem., **32**, 263 (1902).

‡ Selenous and tellurous acids are not precipitated by phosphorous acid from dilute hydrochloric acid solution, but are precipitated from hot concentrated solutions.

the mercury is precipitated completely as mercurous chloride, and is determined as such according to p. 170.

The filtrate containing selenium and tellurium is concentrated, taken up in water, and the selenium separated from the tellurium according to the method of Keller (see below.)

(d) *From Gold and Silver.*

The separation of selenium and tellurium from silver offers no difficulty, inasmuch as the latter can be precipitated by hydrochloric acid and determined as the chloride.

The gold is precipitated as described on p. 257 by oxalic acid and the selenium and tellurium in the filtrate by means of sulphur dioxide. The three metals may also be precipitated together by sulphur dioxide, weighed, and the selenium and tellurium afterward volatilized by roasting, leaving the gold behind.

Tellurium may be separated from gold by precipitating the latter with ferrous sulphate. In the case of selenium, however, it is also precipitated quantitatively by ferrous sulphate from solutions strongly acid with hydrochloric acid.

Separation of Selenium from Tellurium.

*A. Method of E. Keller.**

Keller's method is based upon the fact that tellurous acid is not precipitated from solutions strongly acid with hydrochloric acid while selenium is precipitated quantitatively.

Procedure.—The mixture of the two elements precipitated by sulphur dioxide is dissolved in nitric acid and carefully evaporated to dryness. The dry mass is treated with 200 c.c. of hydrochloric acid (sp. gr. 1.175), boiled to remove the nitric acid and saturated with sulphur dioxide. The precipitated selenium is filtered through a Gooch crucible, washed first with a mixture of 90 vol. HCl (sp. gr. 1.175) and 10 vol. water, then with dilute hydrochloric acid, then with water until free from chloride, finally with absolute alcohol. The selenium is then dried at 105° C. and weighed. The filtrate is diluted with an equal volume of water,

* Jour. Amer. Chem. Soc., 19, 771.

heated to boiling, and the tellurium precipitated by sulphur dioxide and treated in exactly the same way as the selenium.

According to Keller, this method gives thoroughly satisfactory results, as long as the amount of tellurium present does not exceed 5 gms. Even then the separation can be effected by increasing the amount of acid to 450 c.c.

B. The Potassium Cyanide Method.

The precipitate of selenium and tellurium produced by sulphur dioxide is fused with twelve times as much of pure (98 per cent.) potassium cyanide, in an atmosphere of hydrogen, as described on p. 278. The tellurium is almost wholly changed to potassium telluride, K_2Te (a small amount of potassium tellurocyanide is probably formed), while the selenium is changed for the most part into potassium selenocyanide, and to a slight extent into potassium selenide.

The brown melt is dissolved in water, and a slow current of air is conducted through the solution whereby the K_2Te is quantitatively decomposed according to the equation

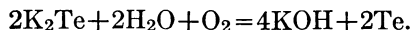

After standing twelve hours the tellurium is filtered off through a Gooch crucible, washed with water, then with absolute alcohol, dried at 105° and weighed.

The colorless filtrate is heated to boiling* in order to change any potassium selenide into the double cyanide; it is then acidified with hydrochloric acid under a good hood (*hydrocyanic acid!*), filtered, and the selenium determined according to p. 277.

Remark.—This method gives slightly low results for tellurium and high values for selenium. This is due to the fact that a little potassium tellurocyanide is formed by the fusion and this compound is not decomposed by the current of air, but is subsequently precipitated with the selenium on acidifying the solution.

* Cf. p. 279.

Determination of Selenium and Tellurium in Crude Copper.

Many copper ores contain selenium and tellurium, so that the crude copper obtained from such ores always contains these elements. The amount present may be determined, according to Keller,* as follows: According to the amounts of selenium and tellurium present, from 5 to 100 gm. of the copper are taken for the analysis. The sample is dissolved in nitric acid and an excess of ammonia is added whereby the phosphorus, arsenic, antimony, tin, bismuth, selenium, and tellurium are precipitated together with the ferric hydroxide, while the copper is held in solution by the excess of ammonia. The precipitate is filtered off and washed with dilute ammonia-water until the copper is completely removed. The precipitate is dissolved in hydrochloric acid and this solution saturated with hydrogen sulphide in the cold, whereby selenium and tellurium together with arsenic, antimony, tin, and bismuth are thrown down as sulphides and are separated by filtration from the iron and phosphorus. The precipitate thus obtained is treated with sodium sulphide and filtered. The filtrate containing all the selenium and tellurium in the presence of arsenic, antimony, and tin as sulpho salts is acidified with nitric acid and carefully evaporated to dryness. The residue is dissolved in 200 c.c. of hydrochloric acid (sp. gr. 1.175) and treated as described on p. 282, A.

MOLYBDENUM, Mo. At. Wt. 96.0.

Form: **Molybdenum Trioxide, MoO₃.**

If the molybdenum is present as ammonium molybdate, a weighed portion is heated in a spacious porcelain or platinum crucible, at first carefully and later to a dull red heat; this leaves the molybdenum trioxide behind in the form of a dense powder, appearing yellow when hot and almost white when cold.

There is no danger of losing any of the molybdenum by volatilization, provided the dull red heat is not exceeded.

If the molybdenum is present as alkali molybdate, it is changed to mercurous molybdate or to its sulphide, and then analyzed as described below.

* Jour. Amer. Chem. Soc., 22, 241.

Precipitation of Molybdenum as Mercurous Molybdate.

In the course of analysis it is frequently necessary to determine molybdenum in alkali molybdates obtained by fusion with an alkali carbonate.

The greater part of the alkali is neutralized with nitric acid, and to the slightly alkaline solution a barely acid solution of mercurous nitrate is added until no further precipitation is effected. The liquid is then heated to boiling, the black precipitate, consisting of mercurous carbonate and mercurous molybdate, is allowed to settle, is filtered and washed with a dilute solution of mercurous nitrate. The precipitate is dried, transferred as completely as possible to a watch-glass, and the precipitate remaining on the filter is dissolved in hot dilute nitric acid into a large porcelain crucible. The solution is then evaporated to dryness, the main portion of the precipitate added to the residue, and the whole is heated very carefully over a low flame until the mercury is completely volatilized, after which the residual molybdenum trioxide is weighed.

Remark.—It was formerly customary to add a slight excess of mercurous nitrate solution and then to add mercuric oxide to neutralize the excess of nitric acid (the solution of mercurous nitrate contains free nitric acid). According to the above procedure of Hillebrand, the addition of mercuric oxide is wholly superfluous, for the basic mercurous carbonate suffices to remove the slight amount of free nitric acid.

Precipitation of Molybdenum as Molybdenum Sulphide.

The precipitation of molybdenum as the sulphide can take place in two different ways: either the acid solution may be precipitated by hydrogen sulphide gas, or the solution of ammonium sulphomolybdate may be acidified with dilute acid.

(a) *Precipitation of Molybdenum Sulphide from Acid Solutions.*

The molybdenum solution, slightly acid with sulphuric acid,* is placed in a small pressure-flask and saturated in the cold with hydrogen sulphide. The flask is closed, heated on the water-

* In many cases, e.g., for the separation of Mo from Ba, Sr, and Ca, it is necessary to effect the separation in a *hydrochloric* acid solution.

bath until the precipitate has completely settled, and filtered after it has become cold. The precipitate is washed with very dilute sulphuric acid and finally with alcohol until the acid has been completely removed. The moist filter is placed in a large porcelain crucible and dried upon the water-bath. The crucible is then covered and very carefully heated over a small flame until no more hydrocarbons are expelled. The cover is then removed, the carbon burned from the sides of the crucible at as low a temperature as possible, and, by raising the temperature gradually, the sulphide is changed to oxide. The operation is finished when no more sulphur dioxide is formed. After cooling, a little mercuric oxide suspended in water is added to the contents of the crucible, the mixture is well stirred, evaporated to dryness on the water-bath, the mercuric oxide is removed by gentle ignition, and the residue of molybdenum trioxide is weighed. The mercuric oxide is added in order to remove particles of unburned carbon.

It is much easier to transform the molybdenum trisulphide into the oxide as follows: The sulphide is filtered through a Gooch crucible, washed with water containing sulphuric acid, and then with alcohol, and dried at 100° C. The crucible is placed within a larger nickel one, covered with a watch-glass,⁶ and carefully heated over a small flame whereby the sulphide is for the most part changed to the oxide. As soon as the odor of sulphur dioxide can no longer be detected, the watch-glass is removed and the open crucible heated until it is brought to a constant weight. The molybdenum oxide thus obtained always contains traces of SO₃, and consequently has a bluish appearance. The results, nevertheless, are excellent.

(b) Hydrogen Sulphide is passed into the Ammoniacal Molybdenum Solution

until it assumes a bright-red color, when it is acidified with sulphuric acid and the precipitate treated as described under (a).

The Separation of Molybdenum from the Alkalies

can take place by precipitation as mercurous molybdate or as sulphide, as described above.

* To avoid loss by decrepitation.

Separation of Molybdenum from the Alkaline Earths.

The substance is fused with sodium carbonate, the melt extracted with water and filtered. The solution contains all the molybdenum as alkali molybdate, while the alkaline earths remain undissolved as carbonates. From the aqueous solution the molybdenum is determined as previously described.

Separation of Molybdenum from the Metals of the Ammonium Sulphide Group.

The molybdenum is precipitated as sulphide (preferably from a sulphuric acid solution) by treatment with hydrogen sulphide under pressure (see p. 286). If the solution contains titanium, it is better to first add ammonia and ammonium sulphide, whereby the metals of Group III will be precipitated and the molybdenum will remain in solution in the form of its sulpho salt. After filtration, the molybdenum is precipitated as sulphide by the addition of acid (see p. 286, *b*).

Separation of Molybdenum from the Metals of Group II.

(*a*) From Lead, Copper, Cadmium, and Bismuth.

The solution is treated with caustic soda and then with sodium sulphide, digested some time in a closed flask, and filtered. The molybdenum remains in solution as its sulpho salt, while the other metals are precipitated as sulphides. After filtering, the solution is acidified with sulphuric acid and heated in a pressure-flask until the precipitate has settled and the supernatant liquid appears colorless. After allowing to cool, the molybdenum sulphide is filtered off and converted to oxide, as described on p. 286.

(*b*) From Arsenic.

The solution, which must contain the arsenic as arsenic acid, is treated with ammonia, the arsenic precipitated by magnesia mixture (see p. 206) and filtered off. The filtrate is acidified with sulphuric acid and the molybdenum precipitated as sulphide by means of hydrogen sulphide.

Separation of Molybdenum from Phosphoric Acid.

The phosphoric acid is precipitated from the ammoniacal solution as magnesium ammonium phosphate (see phosphoric acid) and the molybdenum is precipitated as sulphide from the filtrate (cf. p. 285, *a*). Another way is to saturate the ammoniacal solution with hydrogen sulphide, acidify with hydrochloric acid, and then precipitate the molybdenum as sulphide. In the filtrate the phosphoric acid is precipitated as magnesium ammonium phosphate under the customary conditions.

TUNGSTEN, W. At. Wt. 184.0.

Tungsten is determined as its trioxide, WO_3 .

If the tungsten is present as ammonium tungstate, as mercurous tungstate, or as tungstic acid, it is readily changed by ignition in the air to yellow tungsten trioxide. Care should be taken not to heat strongly or some of the tungstic acid will be lost by volatilization. The crucible should be uncovered and the full heat of the burner should not be used. When ignited over a Meker burner in a covered platinum crucible, a slow volatilization of tungstic acid takes place.*

If the tungsten is present as alkali tungstate, the tungstic acid may be precipitated as such, or by means of mercurous nitrate as mercurous tungstate; by ignition the yellow trioxide is obtained and weighed.

Precipitation of Tungstic Acid.

The aqueous solution of the alkali tungstate is treated with an equal volume of concentrated hydrochloric acid, evaporated to dryness on the water-bath and heated for an hour in the hot closet at 120° . The residue is moistened with a little hydrochloric acid, diluted, boiled, filtered and washed with 6 per cent. hydrochloric acid, or with 10 per cent. ammonium nitrate solution. The yellow tungstic acid is ignited and weighed. In this way the greater part of the tungstic acid is precipitated, but there remains in the filtrate a weighable amount which can be recovered by repeated evaporations with hydrochloric or nitric acid.

* Experiments of W. T. Hall and D. Belcher.

Remark.—The reason why the tungstic acid is not removed completely by the first treatment with nitric or hydrochloric acid is that there is always a small amount of an acid tungstate formed:



which it is hard to decompose by acids. If, however, the filtrate is evaporated to dryness with ammonia, then, according to Philipp,* the acid tungstate is converted into ordinary tungstate,

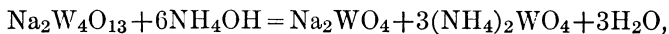

and the latter is decomposed by the nitric acid treatment.

This is true, but acid tungstate is formed again on evaporating. When alkali or ammonium salts are present it is advisable to add a solution of cinchonine hydrochloride which will cause complete precipitation of tungstic acid (see Appendix I).

The washing of a precipitate with acid, or with ammonium nitrate solution, is necessary in order to prevent the formation of hydrosol, which would result if pure water were used.

Precipitation of Tungsten as Mercurous Tungstate, according to Berzelius.†

In the majority of cases it is a question of separating tungstic acid from a solution obtained after fusing with sodium carbonate.‡ The concentrated solution is treated with a few drops of methyl orange, nitric acid is added until the indicator turns pink, the solution is boiled to expel all the carbonic acid, allowed to cool and then an excess of mercurous nitrate solution is added. The yellow precipitate settles quickly and the supernatant liquid should appear clear as water. After standing three or four hours, the precipitate is filtered off, washed with water containing mercurous nitrate (5 c.c. saturated mercurous nitrate solution diluted with water to 100 c.c.) dried, ignited in a porcelain crucible under a good hood, using the flame of a Bunsen burner, and weighed as WO_3 .

* Ber., 15, 501 (1882).

† Jahresber., 21, II, 143. Cf. O. v. der Pfordten, Ann. 222, 152 (1883).

‡ Calcium tungstate is not decomposed completely by a single fusion with sodium carbonate. It is best to decompose it by repeated treatment and evaporation with hot six-normal hydrochloric acid.

Ferrous tungstate can be decomposed satisfactorily in the same manner, but it is well to ignite gently the residue obtained by evaporation between successive treatments. *Experiments of W. T. Hall and D. Belcher.*

Remark.—The tungstic acid is quantitatively precipitated by a single treatment with mercurous nitrate. The process is preferable to the above, therefore, when nothing else is present which precipitates under the same conditions.

Precipitation of Tungsten as Benzidine Tungstate, according to G. v. Knorre.*

If a neutral solution of sodium tungstate is treated with benzidine hydrochloride, a white flocculent precipitate of benzidine tungstate is formed and the precipitate is insoluble in water containing benzidine hydrochloride; when formed in the cold it is hard to filter and, on being washed with pure water, tends to run through the filter. If the precipitate is formed from a hot solution, however, it comes down in a more compact condition and after cooling † can be easily filtered and washed without loss with water containing benzidine hydrochloride.

The moist precipitate is ignited in a platinum crucible, heated to 800° in an electric oven, and the residue of WO_3 is weighed.

The precipitation can also take place satisfactorily from a cold solution if, before adding the precipitant, a little dilute sulphuric acid or alkali sulphate is added to the solution. In this case a mixture of crystalline benzidine sulphate and amorphous benzidine tungstate is formed which can be filtered after standing five minutes. The benzidine sulphate is entirely volatile, so that equally good results are obtained by either of the above two procedures.

If the tungsten is present as tungstate after fusing with sodium carbonate, the melt is dissolved in water, a little methyl orange is added to the clear solution, then hydrochloric acid until the pink color is obtained, and finally 10 c.c. of 0.1 N. sulphuric acid. Benzidine hydrochloride gives a precipitate which can be filtered in five minutes. The washing with dilute benzidine hydrochloride is continued until the evaporation of a few drops of the filtrate on platinum foil leaves no weighable residue. The precipitate is ignited wet as described above.

* Ber., 38, 783 (1905).

† Since benzidine tungstate is appreciably soluble in hot water containing benzidine hydrochloride, it is necessary in all cases to postpone the filtration until the solution is cold.

Preparation of the Benzidine Solution.

Twenty grams of commercial benzidine are triturated in a mortar with water, washed with about 400 c.c. of water into a beaker, treated with 25 c.c. hydrochloric acid (sp. gr. 1.2), heated until solution is completed and a brown liquid is formed, which is filtered and diluted to a volume of one liter.* Of this solution, 5.6 c.c. are sufficient to precipitate 0.1 gm. of WO_3 .

If the analysis is carried out with the aid of sulphuric acid, it is necessary to add at least one cubic centimeter of the benzidine solution for 10 c.c. of 0.1 N sulphuric acid added.

Preparation of the Wash Liquid.

Ten c.c. of the above solution are diluted with distilled water to a volume of 300 c.c.

Remark.—The method is excellent. W. Kunz found 0.1028 gm., 0.1029 gm., 0.1026 gm. and 0.1033 gm. in aliquot parts of a solution supposed to contain 0.1029 gm. of WO_3 .

Determination of Tungsten in Tungsten Steel.*(a) Method of G. v. Knorre.†*

Von Knorre observed that on dissolving tungsten steel in hydrochloric or dilute sulphuric acid, out of contact with the air, all the tungsten remains behind as metal, contaminated with more or less iron. If the finely divided tungsten is filtered off, it oxidizes quickly in the air, forming grayish-yellow tungstic acid, which on further washing with water gives a turbid filtrate; the tungstic acid does not pass through the filter if, instead of using water, the washing is accomplished with a dilute solution of benzidine hydrochloride. By the treatment of the tungsten steel with acids, therefore, the greater part of the iron is separated from the tungsten. To complete the separation, the washed precipitate is ignited wet in a platinum crucible, the residue is fused with four times as much sodium carbonate, the melt

* Instead of dissolving the benzidine in hydrochloric acid, 28 gms. of benzidine hydrochloride may be dissolved in 1 liter of water to which 6 c.c. of hydrochloric acid have been added.

† Ber., 38, 783 (1905).

extracted with a water, the ferric oxide filtered off, and the tungsten determined as described on p. 289. It is probable that aluminium-tungsten alloys can be analyzed in a similar manner.

(b) **L. Wolter's Method.***

L. Wolter, who has carefully studied the determination of tungsten in tungsten steel, found that most of the methods are unpractical because they require the metal in a very fine condition. Now a steel with a high percentage of tungsten is so hard that it is practically impossible to get borings or filings without the steel tools becoming badly worn; in such cases the sample to be analyzed becomes contaminated with foreign material and the accuracy of the analysis is affected. For this reason if it is required to analyze a steel with a high percentage of tungsten, it should suffice to hammer the sample in a steel mortar until a coarse powder is obtained. Unfortunately a coarse powder dissolves extremely slowly in dilute or concentrated acids and fusion with sodium carbonate and potassium nitrate, or with sodium peroxide, has little effect upon large particles; it is otherwise with a potassium bisulphate fusion, whereby even large particles of tungsten steel are readily attacked.

Procedure.—From 0.2–0.5 gm. of the coarse material, which may be in the form of coarse pieces, is fused in a 40–45 c.c. platinum crucible with thirty times as much potassium bisulphate. To prevent too violent effervescence, at first only one-third of the bisulphate is added and the well-covered, inclined crucible is heated over a small flame until white vapors are evolved. The flame is then removed for half a minute because a fairly violent reaction is now taking place within the crucible. In fact when this point is reached, a strong effervescence can be heard. After cooling somewhat, the remainder of the bisulphate is added in two separate portions. The reaction now takes place more slowly and the temperature is raised until the bottom of the crucible begins to redden and dense white vapors are evolved. The heating is now carefully continued until finally

* Chem. Ztg., 1910, 2.

the whole crucible is heated to redness. After about fifteen minutes the reaction will be finished. The molten mass in the crucible should show merely a gentle evolution of gas and there should be no black particles of unattacked steel visible. When this point is reached, the mass is allowed to cool, the crucible and cover boiled with water, carefully washed, and the water added is measured so that the volume of the solution will amount to about 60 or 75 c.c. The liquid, which is somewhat turbid with tungstic acid, is treated with 20 c.c. of concentrated hydrochloric acid and boiled until the precipitated tungstic acid has become a pure yellow. After standing half an hour on the water-bath, the solution is filtered through a small filter and the precipitate washed with 10 per cent. ammonium nitrate solution. The lemon-yellow precipitate is dissolved on the filter in hot, dilute ammonia, the solution caught in a weighed platinum crucible, and the filter washed with ammonium nitrate. The solution of ammonium tungstate in the crucible is evaporated to dryness on the water-bath, then covered with a watch-glass, and very cautiously heated over a free flame until no more ammonium salts are evolved. After igniting the residue over the full flame of a Bunsen burner, it is weighed as WO_3 . In this way the greater part of the tungsten is obtained. The filtrate from the tungstic acid precipitate still contains tungsten. In order to recover the later, it is treated as described on page 288. If the steel contained silicon, the weighed tungstic acid will always contain silica; it is covered with a few drops of hydrofluoric acid, evaporated to dryness, again treated with hydrofluoric acid, evaporated once more and finally ignited over the flame of a Bunsen burner. The crucible will now contain no silica, but only tungstic acid.

Separation of Molybdenum from Tungsten.

(a) *The Sulphuric Acid Method.*

This method, proposed by M. Ruegenberg and E. F. Smith,* depends upon the fact that unignited molybdic acid is readily dis-

* J. Am. Chem. Soc., 22, 772.

solved by warming with sulphuric acid (sp. gr. 1.378), while tungstic acid is not.

W. Hommel* tested this method in the author's laboratory, and could not obtain good results except by digesting the moist oxides with *concentrated* sulphuric acid, and afterward diluting with three times as much water.

Procedure.—(α) Both acids are present in a moist, freshly precipitated state.

The mixture is covered with concentrated sulphuric acid in a porcelain dish and heated over a free flame. By this means, usually a small amount of the tungstic acid is oxidized to the blue oxide, so that the yellow precipitate of tungstic acid is tinted with green. On adding one or two drops of dilute nitric acid, the green color disappears and the tungstic acid is of a pure yellow color. After digesting for half an hour, the separation is complete. After cooling, the liquid is diluted with three times its volume of water, filtered, washed with water containing sulphuric acid, then two or three times with alcohol, ignited (after burning the filter by itself) in a porcelain crucible, and weighed as WO_3 .

The molybdenum is precipitated from the filtrate by passing hydrogen sulphide into the sulphuric acid solution in a pressure-flask, and the precipitate is treated as described on p. 286.

If only a little sulphuric acid is used for the separation, the filtrate from the tungstic acid can be evaporated in a platinum dish, the sulphuric acid driven off for the most part, and the residue washed into a weighed platinum crucible with ammonia, and then evaporated, ignited, and weighed. In case large amounts of molybdenum are present, however, it is always safer to precipitate the molybdenum as sulphide.

(β) *Tungsten and Molybdenum are Present in the Form of their Ignited Oxides.*

These ignited oxides cannot be separated by treatment with sulphuric acid. According to W. Hommel, they can readily be brought into solution by heating for half an hour on the water-bath with concentrated ammonia in a pressure-flask, shaking frequently.

After cooling, the contents of the flask, whether dissolved or

* Inaug. Dissert., Giessen, 1902.

not, are washed into a porcelain dish, evaporated to dryness, and treated as described under (α).

It is still better to fuse the ignited oxides with four times as much sodium carbonate, and treat the melt as described under (α).

(b) *Sublimation Method.**

If a mixture of the trioxides of tungsten and molybdenum, or of their alkali salts, is heated at 250–270° C. in a current of dry hydrochloric acid, the molybdenum is volatilized completely as $\text{MoO}_3 \cdot 2\text{HCl}$, which collects on the cooler parts of the tube as a beautiful, white, woolly sublimate, while the tungsten trioxide remains behind in the boat.

Procedure.—The oxides of the two elements, or their sodium salts, are weighed into a porcelain boat, and the latter is placed in a tube made of difficultly fusible glass, of which one end is bent vertically downward and is connected with a Péligré tube containing a little water. The horizontal arm of the tube is passed through a drying-oven (to serve as an air-bath) (see Fig. 19, p. 33), and is connected with apparatus for generating hydrochloric acid gas. The hydrochloric acid before reaching the tube is slowly passed through a flask containing concentrated hydrochloric acid, and then through sulphuric acid. As soon as the temperature has reached about 200° C. the sublimation of the molybdenum begins. From time to time the sublimate collecting in the tube is driven toward the Péligré tube † by carefully heating with a free flame, so that it will be possible to see whether any more molybdenum is being volatilized. After heating for an hour and one-half or two hours, the operation is usually complete. The boat, now containing tungsten trioxide, or the latter with sodium chloride, is removed, and in case only the former is present, it is weighed after drying in a desiccator over caustic potash. In case, however, sodium chloride is present (when the tungsten was originally present as sodium tungstate) this is removed by treatment with water, and the filtered WO_3 is weighed.

* Péchard, Comptes rendus, 114, p. 173, and 46, p. 1101.

† By the absorption of the $\text{MoO}_3 \cdot 2\text{HCl}$ in the water of the Péligré tube, the brick-red acid chloride, $\text{Mo}_3\text{O}_5\text{Cl}_8$, is often formed:

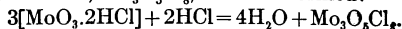

This substance is insoluble in hydrochloric acid, but readily soluble in nitric acid.

For the determination of the molybdenum, the sublimate in the tube is washed out by means of water containing a little nitric acid, and finally the nitric acid solution of the entire sublimate is carefully evaporated to dryness in a porcelain dish. The residue is dissolved in ammonia, washed into a porcelain crucible, evaporated to dryness, and changed to the oxide by gentle ignition.

(c) *The Tartaric Acid Method of H. Rose.*

The alkali salts of the two metals are dissolved in considerable tartaric acid, an excess of sulphuric acid is added, and the molybdenum precipitated according to p. 285, by hydrogen sulphide in a pressure-flask. The molybdenum sulphide is filtered off and changed by roasting in the air to the trioxide. For the determination of the tungsten, the tartaric acid is first destroyed by repeated evaporation with nitric acid, and the precipitated tungstic acid is finally filtered off and changed by ignition to the trioxide.

Remark.—This method gives correct results, but is not so satisfactory as the preceding one on account of the time consumed in removing the tartaric acid.

Analysis of Wolframite (Wolfram).

The monoclinic Wolframite is an isomorphous mixture of Ferberite, FeWO_4 , and Hübnerite, MnWO_4 , but often contains small amounts of silicic, niobic, tantallic, and stannic acids, besides calcium and magnesium.

About 1 gm. of the extremely finely-powdered mineral is fused with 4 gms. sodium carbonate in a platinum crucible over a good burner for from one-half to three-quarters of an hour.* After cooling, the melt is boiled with water and filtered. The residue contains iron, manganese, calcium, and magnesium, and sometimes small amounts of niobic and tantallic acids. The solution contains all the tungstic acid, and silicic acid (stannic acid).

The tungstic acid is separated, as above described, either by evaporating with nitric acid or by precipitating with mercurous nitrate. The precipitate is ignited, and weighed as impure WO_3 .

* It is impossible to decompose alkaline earth tungstates completely by one fusion with sodium carbonate. Fusing with sodium peroxide and carbonate in an iron or nickel crucible is more effective. It is difficult, however, to precipitate all of the tungstic acid by evaporation with acid and precipitation with mercurous nitrate often gives impure precipitates. A more satisfactory method for the analysis of tungsten minerals will be found in Appendix I.

The oxide obtained in this way almost always contains silicic acid and sometimes stannic acid. To remove the former the residue is heated with hydrofluoric and sulphuric acids, first on the water-bath and finally over a free flame, and the residue is weighed. The difference shows the amount of silicic acid present. Stannic acid is usually present in such small amounts that it is not usually determined.

The separation of tungsten from tin, however, may be effected (according to Rammelsberg) by repeated ignition with pure, dry ammonium chloride. The tin is volatilized as stannic chloride, while the tungsten remains behind.

This last operation is conducted as follows: The residue obtained after the treatment with hydrofluoric acid is mixed with six to eight times as much ammonium chloride, the crucible is placed within a second larger crucible,* and the latter is covered and ignited until the ammonium chloride is completely expelled. This operation is repeated three times. The inner crucible is then heated with ready access of air until its contents become of a pure-yellow color, after which it is cooled and weighed. The ignition with ammonium chloride and weighing of the residue is repeated until a constant weight is obtained.

To determine the iron, manganese, calcium and magnesium, the insoluble residue from the sodium carbonate fusion is dissolved in hydrochloric acid, the solution evaporated to dryness, the dry residue moistened with concentrated hydrochloric acid which is allowed to act for ten minutes, then diluted with water, boiled and any silica filtered off. In the filtrate, the iron is separated from the other metals by the basic acid acetate process described on p. 152. The manganese is precipitated by heating with bromine (see p. 123) and the calcium and magnesium separated as described on p. 77.

Remark.—For the determination of niobium and tantalum, a larger portion of the substance, about 5 gms., must be taken. The finely-powdered material is treated with hydrochloric acid to which about one-fourth of its volume of nitric acid has been added, and digested on the water-bath until the residue is colored a pure yellow. The latter is filtered off, washed with water containing acid

* This is to prevent any stannic oxide from collecting on the outside of the crucible; the oxide is formed when tin chloride comes in contact with moist air.

until the iron reaction can no longer be obtained, when the residue is taken up in ammonia and filtered; in this way the tungstic acid is removed. The residue is usually dark-colored and consists of enclosed mineral as well as silicic, stannic, niobic, and possibly tantallic acids. It is treated with aqua regia again, water is added, and the filtered residue is once more treated with ammonia. The final residue is now free from tungsten; it is ignited, weighed, and freed from silica by treatment with sulphuric and hydrofluoric acids. The residue of tin dioxide and niobium pentoxide (and perhaps tantalum pentoxide) is placed in a porcelain boat and ignited in a current of hydrogen. The metallic tin is extracted with hydrochloric acid, and the residue, consisting of $Nb_2O_5(Ta_2O_5)$, is weighed.

Iron alloys rich in tungsten are acted upon only slowly by aqua regia. If, however, they are first roasted in the air, they are comparatively easily brought into solution.* Decomposition by a potassium bisulphate fusion is still better (see p. 292).

Analysis of Tungsten Bronzes.

The analysis of these alkali salts of complex tungsten acids, discovered by Wöhler in 1824,† offered for a long time considerable difficulty on account of the fact that acids do not decompose them very readily.

By fusion with alkalies in the air, or better still in the presence of potassium nitrate, the tungsten bronzes can be converted without difficulty into normal alkali tungstate, and the tungsten determined by one of the methods already described. It is obvious that the alkalies cannot be determined in the same sample, so that Philipp‡ proceeded as follows:

The bronze is treated with ammoniacal silver nitrate solution, whereby the WO_2 is oxidized to WO_3 with the precipitation of an equivalent amount of silver, whereas the whole of the tungsten remains in solution in the form of alkali and ammonium tungstates. In the filtrate obtained after filtering off the deposited silver, the

* Preusser. *Zeit. f. anal. Chem.*, 1889, p. 173.

† *Pogg. Ann.*, 2, 350.

‡ *Berichte*, 15, 500 (1882).

tungstic acid is precipitated by treatment with nitric acid and determined as WO_3 . After removing the excess of silver, by precipitating it as the chloride, the filtrate is evaporated to dryness with the addition of sulphuric acid, and the alkali weighed as sulphate.

Although the above method affords satisfactory results in the analysis of bronzes containing comparatively little tungsten, it is wholly inadequate in the case of bronzes rich in tungsten. The method of Brunner,* which follows, is applicable in all cases. It is based upon the fact that the bronzes can be transformed very easily, and without loss of alkali, into normal tungstates by heating them with ammonium persulphate, or ammonium acid sulphate.

Procedure.—About 0.5 gm. of the finely-powdered bronze is treated in a porcelain crucible with 2 gms. of alkali-free ammonium sulphate and 2 c.c. of concentrated sulphuric acid † and carefully heated over a very small flame. During the heating the contents of the crucible are frequently shaken about a little by cautiously moving the crucible. The escape of gases from the crucible soon ceases and when sulphuric acid vapors begin to be evolved, the decomposition of the bronze results.

In the case of sodium and lithium bronzes, the fused mass appears greenish, whereas with a potassium bronze the color is yellowish white. After a part of the ammonium sulphate has been volatilized, the mass in the crucible is allowed to cool, another gram of ammonium sulphate is added and 1 c.c. of concentrated sulphuric acid, whereupon the contents of the crucible are once more heated as before until sulphuric acid fumes come off thickly; the crucible is then allowed to cool.

The greenish or yellowish-white fusion is softened by treatment with water and rinsed into a porcelain dish. After adding 50 c.c. of concentrated nitric acid, the contents of the evaporating dish are digested on the water-bath for three or four hours, and

* Inaug. Dissert, Zürich, 1903.

† If ammonium persulphate is used the addition of sulphuric acid is unnecessary. The only objection to the use of the persulphate lies in the fact that the commercial salt often contains some potassium persulphate.

then, after diluting with water, the residue of pure yellow tungstic acid is filtered off.

In order to recover the small amount of tungstic acid remaining in the filtrate, it is evaporated as far as possible on the water-bath, allowed to cool, diluted with a little water, carefully treated with an excess of ammonia, again evaporated on the water-bath and treated as described on p. 288.

The final filtrate from the tungstic acid determination is evaporated to dryness, the ammonium salts expelled by ignition and the residue of alkali sulphate weighed (cf. pp. 41 and 42).

Separation of Tungsten from Tin. Augenot's Method.*

One gram of the finely powdered mineral is intimately mixed in an iron crucible with 8 gms. of sodium peroxide, and the mixture is carefully fused over the Bunsen burner for about fifteen minutes. After cooling, the melt is softened with water and transferred into a 250-c.c. flask (if lead is present, carbon dioxide is conducted into the solution for a few minutes), the solution is diluted to the mark, well mixed and filtered through a dry filter, rejecting the first few c.c. of the filtrate.

For the determination of the tungstic acid, Augenot proceeds according to H. Bornträger.† 100 c.c. of the filtrate are allowed to flow into a mixture of 15 c.c. concentrated nitric acid and 45 c.c. of concentrated hydrochloric acid, evaporated to dryness in a porcelain dish, the dry residue treated with 50 c.c. of a solution 1000 c.c. water, 100 g. concentrated hydrochloric acid and 100 g. ammonium chloride, filtered and washed with the same solution. The precipitate, which, besides the tungstic acid, also contains silicic acid and stannic oxide, is dissolved in warm ammonia water, the filter well washed with the same reagent, and the ammoniacal solution allowed to flow into 15 c.c. of concentrated nitric acid and 45 c.c. of concentrated hydrochloric acid. This time the liquid is evaporated to complete dryness, is taken up with the above mixture of hydrochloric acid and ammonium chloride, filtered and washed finally with dilute nitric

* Z. angew. Chem., 19, 140 (1906).

† Z. anal. Chem., 39, 361 (1900).

acid (using preferably a Munroe crucible), and ignited in an electric oven; or in case the latter is not available, the crucible is placed inside a larger one of platinum and ignited over a Teclu burner to constant weight. The resulting tungstic acid is said to be free from silica and stannic oxide.¹

For the determination of the tin, a second 100 c.c. of the original alkaline solution is used. It is treated with 45 c.c. of concentrated hydrochloric acid, whereby tungstic acid and stannic acid are precipitated. At this point 2 or 3 gms. of pure zinc are added whereby the tungstic acid is changed to the blue oxide and the stannic acid is reduced to metallic tin. The mixture is allowed to stand quietly for an hour at a temperature between 50° and 60°. The tin then goes into solution as stannous chloride, and the greater part of the tungsten remains undissolved in the form of the blue oxide. The latter is filtered off, and washed. In this way the whole of the tin is obtained in an acid solution, in the presence of a small amount of tungsten, which does no harm. The blue oxide on the filter, however, is dissolved in hot, dilute ammonia solution in order to make sure that it contains no trace of metallic tin. If this should be the case, the small particle of tin is dissolved in a little hydrochloric acid and the resulting solution added to the main solution of the tin.

The solution is now diluted with water and the tin precipitated as stannous sulphide by the introduction of hydrogen sulphide gas. The precipitate is filtered, ignited in a porcelain crucible and weighed as SnO_2 (see p. 233). Or, the moist precipitate of stannous sulphide may be dissolved in potassium hydroxide solution and the tin determined by electrolysis (see p. 234).

According to Donath and Müller* a mixture of stannic oxide and tungstic acid may be separated as follows: The mixture is ignited with powdered zinc for fifteen minutes in a covered porcelain crucible. After cooling, the spongy contents of the crucible are heated in a beaker with hydrochloric acid (1:2) until there is no more evolution of hydrogen perceptible. The solution is then allowed to cool somewhat and some powdered potassium

* Wiener Monatshefte, 8, 647 (1887).

chlorate is added little by little until the blue tungsten oxide is completely transformed to yellow tungstic acid, when the liquid no longer shows any blue tinge. It is diluted with one and one-half times as much water, and after standing twenty-four hours the tungstic acid is filtered off, washed first with dilute nitric acid and then with one per cent. solution of ammonium nitrate, dried, ignited, and weighed as WO_3 .

The tin is determined in the filtrate as above.

Separation of Tungstic Acid from Silica.

When a mixture of tungstic and silicic acid is at hand, such as is obtained by evaporation with nitric acid, the silicic acid may be removed by treating the ignited residue with hydrofluoric acid and a large excess of sulphuric acid. The separation does not succeed, however, in the mixture of oxides as obtained after precipitation with mercurous nitrate; for in this case the silicic acid is so enveloped with tungstic acid that some of the former is not volatilized as fluoride. In such cases, as Friedheim* has shown, excellent results may be obtained by the

Method of Perillon.†

The mixture of the ignited oxides is introduced into a platinum boat and heated to redness in a stream of dry hydrogen chloride. Thereby the tungsten is volatilized, probably as an acid chloride, which can be recovered in a receiver containing dilute hydrochloric acid; the silica remains behind in the combustion tube.

Frequently the tungsten is reduced to a blue lower oxide, which is not volatile in a current of hydrochloric acid gas. In such cases, after the apparatus has been allowed to cool, the hydrogen chloride is replaced by air, and the contents of the boat are heated in a current of air. The tube is again allowed to cool, the air replaced by hydrogen chloride, and the tube once more heated

* Z. anorg. Chem., 45, 398 (1905).

† Bull. soc. l'industrie miner., 1884.

to redness. The process is repeated if necessary until finally a residue of pure white SiO_2 is obtained. The molybdic acid hydrochloride, $\text{MoO}_3 \cdot 2\text{HCl}$, in the receiver is evaporated to dryness with nitric acid, and the precipitated WO_3 is filtered, ignited and weighed. Unless the current of hydrogen chloride gas is perfectly free from air, the platinum boat will be strongly attacked.

The bisulphate method of effecting the separation is less accurate (See Vol. I).

VANADIUM, V. At. Wt. 51.2.

Vanadium is determined as the pentoxide, V_2O_5 .

The most convenient method for determining vanadium is a volumetric process, and will be discussed in the chapter on volumetric analysis.

If vanadium is present as ammonium or mercurous vanadate, it can be easily changed to the pentoxide by ignition; the latter is a reddish-brown fusible substance which solidifies as a radiating, crystalline mass. If vanadic sulphide is carefully roasted in the air, it is also changed quantitatively to the pentoxide.

In the analysis of most minerals containing vanadium, the vanadium is separated from the other metals present by fusing with a mixture of six parts sodium carbonate and one part potassium nitrate. After cooling, the melt is extracted with water, whereby the sodium vanadate goes into solution while most of the metals are left behind in the form of oxides or carbonates. If phosphorus, arsenic (molybdenum, tungsten), and chromium are present, these elements also dissolve on treating the melt with water in the form of the sodium salts of the corresponding acids.

In practice, therefore, the vanadium is usually met with as the sodium salt of vanadic acid, and it is a matter of separating it from the aqueous solution obtained after fusing with sodium carbonate and potassium nitrate, and of separating it from the other acids which are likely to accompany it (phosphoric, arsenic, and chromic acids).

Precipitation of Vanadic Acid from the Solution of Sodium Vanadate.

There are two good methods for the separation of vanadic acid from a solution of an alkali vanadate: the Rose method, according to which the vanadium is precipitated as mercurous vanadate, and that of Roscoe, by which it is precipitated as lead vanadate. The Berzelius-Hauer method,* in which the vanadium is precipitated as ammonium metavanadate, was found by Holverscheidt † to give always too low results, but Gooch and Gilbert, ‡ as well as E. Campagne, § obtained correct results by working in an ammoniacal solution, which was saturated with ammonium chloride.

1. *The Mercurous Nitrate Method of Rose.*

The alkaline solution is nearly neutralized with nitric acid and to it is added, drop by drop, a nearly neutral solution of mercurous nitrate || until, after the precipitate has settled, a further addition of the reagent causes no precipitation. The liquid is then heated to boiling, the gray-colored precipitate is allowed to settle and is filtered and washed with water to which a few drops of mercurous nitrate solution have been added. The precipitate is dried, ignited under a good hood, and the residue of V_2O_5 is weighed.

Remark.—In neutralizing the alkaline solution of the vanadate with nitric acid, the solution must on no account be made acid, for in this case nitrous acid (from the nitrate fusion) will be set free and the latter reduces some of the vanadate to a vanadyl salt and the latter is not precipitated by mercurous nitrate. In order to avoid passing over the neutral point, Hillebrand recommends fusing with a weighed amount of sodium carbonate and adding the amount of nitric acid that has been found necessary by a blank test to neutralize this. The method gives good results.

* Pogg. Ann., **22**, 54 and J. prakt. Chem., **69**, 388.

† Dissertation, Berlin, 1890.

‡ Z. anorg. Chem., **32**, 175 (1902).

§ Berichte, **1903**, 3164.

|| The mercurous nitrate used should leave no residue on being ignited.

2. The Lead Acetate Method of Roscoe.*

Principle.—If a solution weakly acid with acetic acid is treated with lead acetate, orange-yellow lead vanadate is quantitatively precipitated. The lead vanadate, however, does not possess a constant composition, so that the amount of vanadium present cannot be determined by weighing the precipitate. After being washed, it is dissolved in as little nitric acid as possible, the lead precipitated as lead sulphate, and the vanadium determined in the filtrate by evaporating the latter, driving off the excess of sulphuric acid, and weighing the residual V_2O_5 .

Procedure.—The solution from the sodium carbonate and potassium nitrate fusion is nearly neutralized as before with nitric acid, an excess of lead acetate solution is stirred into it, when the voluminous precipitate will collect together, rapidly settle to the bottom of the beaker, and the supernatant liquid will appear absolutely clear. The precipitate is at first orange-colored, but on standing it gradually becomes yellow and finally perfectly white. It is filtered off, washed with water containing acetic acid until half a cubic centimeter of the filtrate will leave no residue on evaporation. The precipitate is now washed into a porcelain dish, the part remaining on the filter is dissolved in as little as possible of hot dilute nitric acid, and the solution added to the main part of the precipitate, to which enough nitric acid is added to completely dissolve it. An excess of sulphuric acid is added to the solution, and it is evaporated on the water-bath as far as possible, finally heating over the free flame until dense fumes of sulphuric acid are evolved. After cooling, from 50 to 100 c.c. of water are added, the lead sulphate is filtered off and washed with dilute sulphuric acid until 1 c.c. of the filtrate will show no yellow color with hydrogen peroxide. The lead sulphate should be white and free from vanadium; it will be so provided enough sulphuric acid was used and the mass was not heated until absolutely dry before diluting with water. The filtrate containing all the vanadic acid is evaporated in a porcelain dish to a small volume, transferred to a weighed platinum crucible, evaporated further on the water-bath, and finally in an air-bath until all the sulphuric

* Ann. Chem. Pharm., Suppl., 8, 102 (1872).

acid is removed. The open crucible is then ignited for some time* at a faint-red heat and its contents finally weighed as V_2O_5 .

Remark.—Instead of decomposing the lead vanadate by means of sulphuric acid, Holverscheidt recommends precipitating the lead as sulphide by means of hydrogen sulphide and determining the vanadium in the filtrate. For this purpose the blue-colored filtrate from the lead sulphide precipitate (which contains some vanadyl salt) is boiled to expel the excess of hydrogen sulphide and the deposited sulphur is filtered off. A few drops of nitric acid are added, the solution evaporated to dryness, and the reddish-yellow hydrate of vanadic acid is changed by gentle ignition into the pentoxide of vanadium.

Lead may also be separated from the vanadic acid as lead chloride. In this case the procedure recommended in the analysis of vanadinite (p. 308) is followed.

The separation of vanadium as the sulphide by acidifying a solution of an alkali vanadate that has been treated with an excess of ammonium sulphide is not admissible, for only a part of the vanadium is precipitated as the brown sulphide, the rest remaining in solution in the form of vanadyl salt. H. Rose called the attention of chemists to the inaccuracy of this method, but this has not prevented its being recommended in some of the most recent works on analytical chemistry. The author has carefully tested the method and found it useless.

Separation of Vanadium from Arsenic Acid.

Most minerals containing vanadium also contain arsenic, and after extracting the melt, obtained by fusion with sodium carbonate and nitre, *with water*, both elements go into solution. For their separation, the solution is acidified with dilute sulphuric acid and sulphur dioxide is passed into the hot liquid, whereby the vanadic acid is reduced to vanadyl salt and the arsenic to arsenious acid. After boiling to remove the excess of sulphur dioxide, the solution is saturated with hydrogen sulphide and the precipitate of arsenic trisulphide is filtered off. The filtrate is freed from

* On expelling the sulphuric acid, there is finally formed some green and brown crystals of a compound of vanadic acid with sulphuric acid; these are decomposed only at a faint-red heat.

hydrogen sulphide by boiling, evaporated with nitric acid in order to form vanadic acid again, the solution is then made alkaline with sodium carbonate, and the vanadium determined by one of the above methods.

Separation of Vanadium from Phosphoric Acid.

If the solution of the soda-nitre fusion contains phosphoric as well as vanadic acid, both are precipitated by mercurous nitrate, the precipitate washed with dilute mercurous nitrate solution and weighed. In this way the sum of the $V_2O_5 + P_2O_5$ is obtained. When P_2O_5 is present the V_2O_5 does not melt, but only sinters together. The ignited oxides are fused with an equal weight of sodium carbonate, the melt is dissolved in water, the solution made acid with sulphuric acid and boiled with sulphurous acid in order to reduce the vanadic acid to vanadyl sulphate; the latter will be recognized by the pure blue color which the solution assumes. Carbon dioxide is passed into the boiling solution until the excess of sulphurous acid is removed, when it is allowed to cool. To the cold solution, now about 100 c.c. in volume, 200 c.c. of a 75 per cent. solution of ammonium nitrate and 50 c.c. of ammonium molybdate solution are added (cf. Remark, below), the solution is warmed to about $60^\circ C.$, set aside and allowed to stand for one hour. The clear liquid is then decanted through a filter, washed three times by decantation with 50 c.c. of the proper wash liquid (see p. 437), after which the precipitate is dissolved by passing 10 c.c. of 8 per cent. ammonia through the filter into the beaker containing the bulk of the precipitate and the filter is finally washed with 30 c.c. of water. To this solution 20 c.c. of a 34 per cent. ammonium nitrate solution and 1 c.c. more of ammonium molybdate are added, the solution heated until it begins to boil, and the phosphoric acid reprecipitated by the addition of 20 c.c. of hot 25 per cent. nitric acid. The phosphoric acid is determined by the method of Woy (page 440). The amount of phosphoric acid found is deducted from the sum of the oxides and the difference gives the amount of V_2O_5 .

Remark.—A. Gressly tested this method in the author's laboratory and made the interesting observation that if about 0.15 gm. of V_2O_5 was present with 0.1 gm. P_2O_5 , no trace of the latter could

be detected according to the procedure of Woy, not even on boiling the solution. On the other hand, an immediate precipitation was produced if a stronger solution of ammonium molybdate were used (75 gms. of ammonium molybdate dissolved in 500 c.c. of water) and this solution poured into 500 c.c. of nitric acid, sp. gr. 1:2.

The above-described separation gives correct results only when the vanadium is present as vanadyl sulphate; if vanadic acid is present it is precipitated with the phosphoric acid. If the solution is allowed to stand after the addition of the ammonium molybdate, the vanadyl sulphate is gradually oxidized to vanadic acid; the precipitate therefore should not be allowed to stand long before filtering *

Separation of Vanadium from Molybdenum.

The solution containing the alkali salts of the two acids is acidified with sulphuric acid and the molybdenum precipitated in a pressure-flask by means of hydrogen sulphide, and the precipitate filtered off through a Gooch crucible, as described on pp. 285 and 286), and weighed as MoO_3 . After removing the excess of hydrogen sulphide from the filtrate, the vanadium is oxidized with nitric acid and determined as described under the Separation of Vanadium from Arsenic Acid, p. 306.

Analysis of Vanadinite, $(\text{Pb}_5(\text{VO}_4)_3\text{Cl})$.

Besides lead, vanadic acid, and chlorine, the mineral often contains arsenic and phosphoric acids.

Determination of Chlorine.

About 1 gm. of the finely powdered mineral is dissolved in dilute nitric acid (in order to avoid loss of chlorine the solution is kept cold), and the solution is diluted with considerable water. The chlorine is precipitated with silver nitrate and the weight of the silver chloride determined as described on p. 317.

Determination of Lead.

The filtrate from the silver chloride is treated with hydrochloric acid in order to precipitate the excess of silver, filtered, washed

* A method for determining phosphorus in vanadium steel is given in Appendix I.

with hot water, and the solution thus freed from silver is evaporated to dryness to remove the nitric acid. The dry mass is moistened with hydrochloric acid, 95 per cent. alcohol is added in order to precipitate completely the lead chloride, and the latter is filtered through a Gooch crucible, washed with alcohol, dried at 110° C. and weighed as PbCl_2 .

Determination of Vanadium, Phosphoric Acid, and Arsenic.

The filtrate from the lead chloride contains the vanadium as vanadyl salt. The alcohol is driven off by careful heating on the water-bath, nitric acid is added to the solution, and the latter is repeatedly evaporated in order to oxidize the blue vanadyl salt to brown vanadium pentoxide. The dry mass is washed by means of as little water as possible into a weighed platinum crucible, the residue adhering to the sides of the dish is dissolved in a little ammonia and added to it. The crucible is then heated, at first gradually to expel the ammonia, and afterward more strongly with ready access of air (uncovered crucible) until the reduced, dark-colored oxide is changed over to the brownish-red pentoxide. The temperature is then raised until the vanadium oxide begins to melt. If phosphoric acid is present, its anhydride is weighed with the vanadium and the amount of P_2O_5 is determined as described on p. 307; this amount is deducted from the weight of the two oxides.

The determination of arsenic is best carried out in a separate portion. For this purpose the mineral is dissolved in hot nitric acid, the greater part of the excess of the acid is removed by evaporation, the solution is diluted with water, and the lead precipitated by the addition of sulphuric acid. From the filtrate, the last portions of lead and arsenic are precipitated by hydrogen sulphide, after previous reduction with sulphurous acid. The filtered precipitate is digested with sodium sulphide and the arsenic precipitated from the solution thus obtained by the addition of hydrochloric acid. The arsenic sulphide is then changed to arsenic acid, preferably by dissolving in ammoniacal hydrogen peroxide, and is precipitated as magnesium ammonium arsenate and determined according to p. 206.

Determination of Vanadium and Chromium in Iron Ores and Rocks.

*Method of W. F. Hillebrand.**

As vanadium often occurs in many ores of iron and in rocks, although in very small amounts, it is often of interest and of importance to be able to determine it in such cases. For this purpose it is best to proceed as follows:

Five gms. of the finely powdered mineral are mixed with 20 gms. sodium carbonate and 3 gms. potassium nitrate and fused over the blast-lamp. The green fusion (containing manganese) is extracted with water, a few drops of alcohol are added to reduce the manganese, and the residue is filtered off.†

The aqueous solution contains sodium vanadate and often phosphate, chromate, molybdate, aluminate, and considerable silicate as well. First of all, the aluminium and the greater part of the silicic acid are removed by nearly neutralizing the alkaline solution with nitric acid.‡ It is very important that the solution is not made acid at this point on account of the reducing action of the nitrous acid set free from the nitrite formed during the fusion. The almost neutral solution is evaporated nearly to dryness, taken up in water, and filtered.§

The cold alkaline solution is now treated with an almost neutral solution of mercurous nitrate until no further precipitation takes place. The somewhat voluminous precipitate contains, besides mercurous carbonate, also its chromate, vanadate, molybdate, arsenate, and phosphate, if the corresponding elements are present in the mineral. If the precipitate is too bulky, a little nitric acid is cautiously added, and then a drop of mercurous nitrate in order to see if the precipitation is complete.

* See U. S. Geol. Survey Bull., 411.

† If considerable vanadium is present, the insoluble residue always contains vanadium and must be fused with soda-nitre again.

‡ The amount of nitric acid necessary to neutralize 20 gms. of soda is determined by a blank test.

§ The residue of aluminium hydroxide and silicic acid almost never contains vanadium, but contains chromium. If it is desired to determine the latter, the residue is evaporated to dryness with hydrofluoric and sulphuric acids, the dry mass is fused with soda and nitre again, and the aqueous solution of the melt added to the main solution.

The liquid is heated to boiling, filtered, the precipitate washed with water containing ammonium nitrate, dried, and ignited in a platinum crucible at as low a temperature as possible. The ignited residue is fused with a little sodium carbonate, the melt extracted with water and, if yellow-colored, it is filtered into a 25-c.c. flask and the amount of chromium determined colorimetrically by comparing its color with a carefully prepared solution of potassium chromate.

The solution is then slightly acidified with sulphuric acid, and the molybdenum, arsenic, and traces of platinum precipitated by hydrogen sulphide in a pressure-flask. The precipitated sulphides are filtered off, the filter together with the precipitate is carefully ignited in a porcelain crucible, a few drops of sulphuric acid are added and the crucible heated again until the acid is almost completely removed. On cooling the mass is colored a beautiful blue if molybdenum is present.

The filtrate from the above precipitate is freed from the excess of the hydrogen sulphide by boiling and passing a stream of carbon dioxide through it, and the *hot* solution is then titrated to a pink color with $\frac{N}{100}$ potassium permanganate solution (cf. Vol. Anal.). In order to obtain absolutely accurate results, the solution is now reduced by means of sulphur dioxide and the titration repeated. The mean of the two experiments gives the vanadium value.

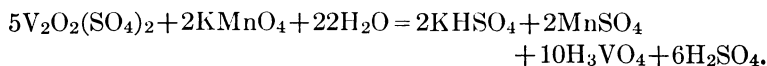

This method gives correct results only when the amount of chromium present is very small, which is true in the majority of cases.

In case more than 5 mgm. of chromium are present a correction must be made, for a measurable amount of permanganate is used up in oxidizing the chromium. This is determined by taking a solution containing the same amount of chromate as the analyzed solution, reducing it with sulphurous acid, and titrating with permanganate. The amount of permanganate now used must be subtracted from the amount used in the analysis, and from the difference the amount of vanadium present is calculated.

Determination of Vanadium and Chromium in Pig Iron.

From 5 to 10 gms. of the iron are dissolved in dilute hydrochloric acid in a flask, meanwhile passing a current of carbon dioxide through the liquid. For each gram of iron taken, 5 c.c. of hydrochloric acid, sp. gr. 1.12 and 10 c.c. of water are used. The solution is hastened by warming, finally boiling it until there is no more evolution of gas. It is now diluted with an equal volume of water, allowed to cool, and, without filtering off the slight residue, an excess of barium carbonate is added and the mixture allowed to stand for twenty-four hours with frequent shaking. The residue is filtered off, rapidly washed with cold water, dried and ignited in a platinum crucible in order to burn off the carbon. Five parts of sodium carbonate and one part of nitre are then added to the contents of the crucible and the mixture is heated to quiet fusion.

The fusion is leached with water and the solution thus obtained contains all the chromium as chromate, and the vanadium as vanadate in the presence of alkali silicate and phosphate. The aqueous solution is now nearly neutralized with nitric acid, being careful not to make the solution acid as the nitrous acid set free will reduce some of the vanadium and chromium. The barely alkaline solution is then treated with an almost neutral solution of mercurous nitrate until no further precipitation takes place, the liquid is heated to boiling, filtered and washed with water containing a little mercurous nitrate. After drying, as much of the precipitate as possible is transferred to a platinum crucible, the filter burned by itself and its ash added to the main portion of the precipitate, which is ignited to remove the mercury. The residue is fused with a little sodium carbonate, the melt extracted with water, and the solution filtered. In case the filtrate is colored yellow, the amount of chromium present is determined colorimetrically* by placing the solution in a graduated cylinder and comparing its color with a potas-

* The colorimetric determination is only suitable when small amounts are present. When considerable chromium is present (chrome steel) the results obtained by the colorimetric determination may be as much as 2 per cent. too high. In such cases the chromic acid is titrated with ferrous sulphate (see Vol. Anal.).

sium-chromate solution containing a known amount of chromium. The solution is then acidified with sulphuric acid and hydrogen sulphide is conducted into the boiling solution to precipitate arsenic and platinum. After filtering, the hydrogen sulphide is removed and the hot solution titrated with $\frac{N}{100}$ potassium permanganate solution (cf. Volumetric Analysis).

Determination of Vanadium, Molybdenum, Chromium, and Nickel in Steel. Method of A. A. Blair.*

The method is given in this edition of the book as illustrating the removal of the greater part of the iron from a ferric chloride solution by shaking with ether. Although it is difficult to effect a perfect separation in this way, still when the conditions are right, almost all of the iron can be removed so that a large sample of steel can be taken for analysis. This particular method has not been tested in the author's laboratory and is not given in the German edition. The ether separation, however, is discussed in many other text-books and deserves mention.—(TRANSLATOR.)

Molybdenum, in this analysis, follows the iron so that when a small amount of the former is present, as is the case in steels, the ether solution may be regarded as containing all of the molybdenum, as well as the greater part of the iron.

Procedure.—Two grams of the steel are dissolved in nitric acid with the addition of hydrochloric acid if necessary. The resulting solution is evaporated to dryness and the residue dissolved by treatment with hot concentrated hydrochloric acid. If silica is present, the solution is diluted and filtered. The hydrochloric acid solution is evaporated to a sirup, the latter dissolved in a little hydrochloric acid, sp. gr. 1.1,† and transferred with the aid of a little more of the same acid to a separatory funnel of about 250 c.c. capacity which is provided with tightly fitting stop-cock and glass-stopper. About 80 c.c. of ether are added to the cold

* J. Am. Chem. Soc., 30, 1228.

† The separation works best with acid of this concentration.

solution* and the mixture is shaken vigorously for half a minute. When the two liquids are in equilibrium, the lower layer is transferred to a second separatory funnel. The stopper of the first funnel is carefully rinsed with hydrochloric acid, sp. gr. 1.1, the contents of the funnel once more shaken, and the lower layer added to the contents of the second funnel. The solution in the latter is shaken with 50 c.c. more of ether, and the acid solution containing all the vanadium, chromium, nickel, manganese and copper, is run into a beaker and freed from dissolved ether by evaporating on the water bath nearly to dryness. An excess of nitric acid is added and the solution again evaporated to remove all the hydrochloric acid. When the solution is almost sirupy, 20 c.c. of hot water are added and the solution is heated with the addition of a little sulphurous acid to reduce any chromic acid that may have been formed. The hot solution is slowly poured, while stirring vigorously, into a boiling 10 per cent. solution of sodium hydroxide. After boiling a few minutes, the precipitate is allowed to settle, is washed twice by decantation, and finally on the filter until the volume of the filtrate is about 300 c.c. The precipitate contains the hydrated oxides of chromium, nickel and iron with the greater part of the manganese and any copper that may have been in the sample. The filtrate contains the vanadium, some silicate and aluminate (from the reagents) and sometimes a little chromium. It is made barely acid with nitric acid, once more made alkaline with a few drops of sodium hydroxide, boiled and filtered.

The vanadium is determined in this last filtrate. It is precipitated as lead vanadate by the addition of 10 c.c. of a 10 per cent. solution of lead nitrate, eventually adding enough acetic acid to make the solution decidedly acid and boiling for several minutes. The lead vanadate is filtered and washed with hot water. The precipitate is dissolved in hot, dilute hydrochloric acid, the solution evaporated nearly to dryness, treated with 50 c.c. of hydrochloric acid, evaporated again, cooled, treated with 10 c.c. concentrated sulphuric acid, and evaporated until fumes

* The warm solution would result in the reduction of some of the iron by the ether.

of sulphuric anhydride are evolved. When cold 150 c.c. of water are added, the solution heated to between 60 and 70° and titrated with permanganate. The evaporation of the vanadate solution with hydrochloric acid and subsequent treatment with sulphuric acid results in the reduction of the vanadium from the quinquevalent to the quadrivalent condition,* and the titration with permanganate makes the vanadium quinquevalent again. Consequently 2 atoms of V are equivalent to 1 atom of oxygen in the titration. The presence of a little iron does not interfere when the vanadium is reduced in the above manner.

The two precipitates obtained by the sodium hydroxide treatment contain chromium, nickel and copper besides iron and manganese. The two filters are ignited and the precipitates fused with about 2 gms. of sodium carbonate and half a gram of potassium nitrate. The fused mass is treated with water and the solution filtered. The residue contains the nickel, copper, iron and part of the manganese; the filtrate contains the chromium and the rest of the manganese. To the filtrate, enough ammonium nitrate is added to convert all the sodium salts to nitrates, and the solution evaporated to small volume with the addition of a few drops of ammonia from time to time. The evaporated solution is diluted to 50 c.c. and filtered. The precipitate consists of hydrated manganese dioxide (alumina and silica from the reagents). The filtrate is boiled to drive off the ammonia, sulphurous acid added to reduce any chromic acid, the excess of reducing agent boiled off, and the chromium precipitated by the careful addition of ammonia to the boiling solution. The precipitate is filtered off, washed and weighed as Cr_2O_3 .

The filter containing the insoluble residue from the above fusion is returned to the same crucible in which the fusion was made and ignited. The ignited oxides are dissolved in hydrochloric acid, the solution diluted and the copper precipitated by hydrogen sulphide. The filtrate is evaporated with sulphuric acid until the hydrochloric acid is all expelled, whereupon it is

* Campagne, *Compt. rend.*, **137**, 570 (1903).

diluted and treated with a large excess of ammonia and the nickel determined by electrolysis (see p. 136).

The ether solution from the two separatory funnels is shaken with water, which causes the separation of an ether layer from the solution containing the iron and molybdenum. The lower layer is, therefore, drawn off; the solution of ferric chloride containing all the molybdenum is evaporated nearly to dryness, the cold solution treated with 10 c.c. of concentrated sulphuric acid and evaporated until the sulphuric acid fumes freely. The cold sulphuric acid solution is diluted with 100 c.c. of water, reduced by the careful addition of ammonium acid sulphite, the excess of sulphurous acid boiled off, and the cold solution saturated with hydrogen sulphide in a 200 c.c. pressure bottle. The bottle is stoppered and heated on the water bath for several hours. After slowly cooling, the precipitate is filtered into a Gooch crucible and washed with water containing a little sulphuric acid and finally with alcohol. The Gooch crucible is placed within a larger porcelain crucible so that the bottom of the former does not touch that of the latter, covered with a watch-glass and heated gradually until there is no more odor of sulphur dioxide. The watch-glass is then replaced by a porcelain crucible cover and the heating is continued until the ignited precipitate becomes bluish white in color.

The Gooch crucible is then heated to faint redness, cooled and weighed. The heating and weighing is repeated until the precipitate ceases to lose in weight. The crucible is then placed in the suction bottle and washed with ammonia until the washings are free from molybdenum. The crucible is again heated and weighed. The difference in weight corresponds to the amount of molybdenum trioxide. A small amount of ferric oxide always remains on the felt.

METALS OF GROUP I.**SILVER, LEAD, MERCUROUS MERCURY (AND THALLIUM).**

The determination of lead and mercury has already been considered; it remains for us to discuss the determination of silver.

SILVER, Ag. At. Wt. 107.88.

Forms: **AgCl and Ag.**

Determination as Silver Chloride, AgCl.

The solution, slightly acid with nitric acid, is heated to boiling and the silver precipitated by the addition of hydrochloric acid, drop by drop, until no more precipitate is formed. The precipitate is allowed to settle in a dark place, filtered through a Gooch crucible and washed, first with water containing a little nitric acid until the chloride test can no longer be obtained, then twice with alcohol or water in order to remove the nitric acid. The precipitate is dried first at 100° C. and finally at 130° C. till a constant weight is obtained. If it is not desired to use a Gooch crucible for this determination, the silver chloride can be filtered upon an ordinary washed filter, washed as before and dried at 100° C. As much of the precipitate as possible is transferred to a weighed porcelain crucible, the filter burned (as described on page 21) in a platinum spiral whereby some of the silver chloride adhering to it will be reduced to metal. The ash of the filter is added to the main portion of the precipitate. It is moistened with a little nitric acid and a drop or two of concentrated hydrochloric acid, dried on the water-bath and then heated over a free flame until the silver chloride begins to melt. After cooling in a desiccator it is weighed.

*Solubility of Silver Chloride.** One liter of water dissolves 0.00154 g. AgCl at 20° and 0.0217 g. at 100°. In water containing a little hydrochloric acid, the AgCl is less soluble than in pure water but as the quantity of hydrochloric acid is increased, the solubility of AgCl rises rapidly. Thus one liter of 1 per cent. HCl dissolves only 0.0002 g. AgCl at 21°, but 1 l. of 5 per cent. HCl dissolves 0.0003 g. and 1 l. of 10 per cent. HCl dissolves 0.0555 g. AgCl.

* G. S. Whitby, Z. anorg. Chem., 67, 108 (1910).

Determination as Metal, Ag.

Metallic silver is obtained by the ignition of silver oxide, carbonate, cyanide or the salt of an organic acid. In the latter case, the substance must be heated very cautiously at first in a covered crucible. When the organic substance is completely charred, the cover is removed from the crucible and the contents are ignited until the carbon is completely burned, and the crucible then weighed.

From the chloride, bromide (but not the iodide) and sulphide, the metal may be obtained by igniting in a current of hydrogen. The reduction of the chloride, bromide, and iodide may be effected very conveniently by passing the electric current through the substance after it has been melted together. The porcelain crucible containing the silver halide is placed in a crystallizing dish and near it is placed a second crucible containing a little mercury and a small piece of zinc. Upon the silver salt is placed a small disk of platinum foil, which is fastened to a platinum wire; the other end of the wire dips in the mercury in the other crucible. The crystallizing dish is filled with dilute sulphuric acid (1:20) so that the crucible is entirely covered with the acid and it is then allowed to stand over night. Next morning all of the silver salt will be found to be reduced. The crucible is removed from the acid, washed with water, dried, ignited, and weighed. By this simple method, E. Lagutt obtained excellent results. If the silver halide has not been fused to a compact mass small particles of the silver precipitate are likely to float around during the operation, and escape reduction.

Silver can also be deposited electrolytically, but this method will not be described in this book, for it offers no particular advantages over the determination as silver chloride with a Gooch crucible.

Separation of Silver from Other Metals.

As almost all metal chlorides* are soluble in dilute hydro-

* Thallium chloride is difficultly soluble in water. If thallium is present the silver is precipitated from a nitrate solution by means of H_2S , ignited in a stream of hydrogen, and weighed as metal. To determine the thallium, the filtrate is evaporated to dryness, the residue dissolved in a little water

chloric acid, silver is separated from the other metals by the addition of hydrochloric acid to the solution. If the solution contains mercurous salts these are oxidized before the addition of the hydrochloric acid by boiling with nitric acid.

For the separation of silver from gold and platinum in alloys consult pages 259 and 270.

and the thallium precipitated by the addition of potassium iodide. The thallium iodide precipitate is washed with dilute potassium iodide solution, then with alcohol, dried at 150° and weighed as TII.

GRAVIMETRIC DETERMINATION OF THE METALLOIDS (ANIONS).

GROUP I.

HYDROCHLORIC, HYDROBROMIC, HYDRIODIC, HYDROCYANIC, HYDROFERROCYANIC, HYDROFERRICYANIC, SULPHOCYANIC, AND HYPOCHLOROUS ACIDS.

HYDROCHLORIC ACID, HCl. Mol. Wt. 36.47.

Form: Silver Chloride, AgCl.

We can distinguish between two cases:

- A. The chloride solution is present either as free hydrochloric acid or as a chloride soluble in water.
- B. It is present in the form of an insoluble chloride.

A. The Chloride is Present in Aqueous Solution.

If only metals of the alkali or alkaline earth groups are present, the cold solution is made slightly acid with nitric acid, and silver nitrate is slowly added with constant stirring until the precipitate collects together and further addition of the reagent produces no more precipitation. The liquid is now heated to boiling, the precipitate allowed to settle in the dark, filtered through a Gooch crucible, and then treated exactly as described in the determination of silver, page 317.

If the aqueous solution contains a chloride of a heavy metal, it is not always possible to follow the above procedure. If, for example, substances are present which on boiling are changed to insoluble basic salts, it is evident that the precipitate of silver chloride would be contaminated with these substances and too high results would be obtained. This is particularly true of stannic and ferric salts. Ferrous salts, on the other hand, in case only little

nitric acid is present, reduce silver nitrate to metallic silver on heating the solution; if enough nitric acid is present to prevent the reduction to silver, the danger of forming basic salts still remains to be feared. In such cases the precipitation is effected as before from a cold solution and the subsequent heating is omitted.

In all cases, however, it is better to first remove the heavy metal by precipitation with ammonia, caustic soda or sodium carbonate.

Example: Analysis of Commercial Tin Chloride.

Tin chloride is obtained either as a solid salt corresponding to the formula $\text{SnCl}_4 + 5\text{H}_2\text{O}$, or as a concentrated aqueous solution.

As both the solid salt and its concentrated solution are very hygroscopic, it is necessary to weigh out the portion for analysis from a stoppered vessel. It is best to proceed as follows:

A large sample of the substance (about 10 gm.) is placed in a tared weighing beaker, closed and weighed. About 10 c.c. of water are added, the salt is completely dissolved to a homogeneous syrup by shaking, and the beaker is again weighed. Four more weighing beakers are now tared and into each is placed about 2 c.c. of the syrup. Each beaker is quickly stoppered and then weighed.

Determination of Tin.—The contents of one of the weighing beakers is washed into a 400–500-c.c. beaker, diluted to about 300 c.c. and a few drops of methyl orange are added, whereby the liquid is colored red. Ammonia solution (free from chloride) is now added until the color of the solution is changed to yellow (an excess of ammonia must be carefully avoided for tin hydroxide is somewhat soluble in ammonia). The solution is then treated with ammonium nitrate (5 c.c. of concentrated ammonia exactly neutralized with nitric acid, sp. gr. 1.2), boiled for one or two minutes, filtered, and washed with water containing ammonium nitrate, and weighed as SnO_2 .

Determination of Chlorine.—The filtrate from the tin hydroxide precipitate is acidified with nitric acid, and precipitated in the cold with silver nitrate. The solution is then heated to boiling and,

after the precipitate has settled, it is filtered through a Gooch crucible, washed with cold water containing a little nitric acid, then with cold water or alcohol, dried at 130° C., and weighed.

The amount of tin and chlorine present is computed as follows;

Weight of Solid Salt = A .

Weight of the Solid Salt + Water = B .

Weight of the Solution taken for Analysis = a .

Weight of the SnO_2 found = p .

Weight of the AgCl found = p' .

Since B gm. of the solution contain A gm. of the solid salt, then the amount a of the solution taken for analysis will contain:

$$B : A = a : x$$

$$x = \frac{A \cdot a}{B} = \text{wt. of substance taken.}$$

This amount of substance yielded p gm. SnO_2 , corresponding to:

$$\text{SnO}_2 : \text{Sn} = p : x'$$

$$x' = \frac{\text{Sn} \cdot p}{\text{SnO}_2}$$

and in percentage:

$$\frac{A \cdot a}{B} : \frac{\text{Sn} \cdot p}{\text{SnO}_2} = 100 : x''$$

$$x'' = \frac{100 \text{ Sn}}{\text{SnO}_2} \cdot \frac{p \cdot B}{a \cdot A} = \% \text{ Sn.}$$

In the same way the amount of chlorine present is found to be:

$$\frac{100 \text{ Cl}}{\text{AgCl}} \cdot \frac{p' \cdot B}{a \cdot A} = \% \text{ Cl.}$$

This analysis may be accomplished much more rapidly by a volumetric process. (Consult Vol. Anal.)

If antimony or stannous compounds are present, the above procedure cannot be used. It has been proposed to add tartaric acid to the solution, then dilute with water and precipitate the chlorine with silver nitrate. It is better, however, to proceed as follows: The antimony is precipitated by hydrogen sulphide as its

sulphide, the excess of the latter is removed by passing carbon dioxide through the solution, after which the precipitate is filtered and washed. The filtrate containing all the chlorine is made slightly ammoniacal, a little hydrogen peroxide or potassium percarbonate is added (both reagents must be free from chloride) and the solution boiled until the excess of the peroxide is destroyed. By this treatment traces of hydrogen sulphide remaining in the solution are oxidized to sulphuric acid. After cooling, the solution is acidified with nitric acid, and the chlorine determined as silver chloride as described above.

According to this method, chlorine may be determined in the presence of large amounts of hydrogen sulphide without difficulty.

It is less practical to proceed as follows: The solution is saturated with ammonia and the hydrogen sulphide is precipitated by the addition of ammoniacal silver nitrate solution, the deposited silver sulphide is filtered off, washed with ammonia, and the silver chloride precipitated from the filtrate by acidifying with nitric acid.

B. Analysis of an Insoluble Chloride.

The substance is boiled with sodium carbonate solution * (free from chloride), and the chlorine determined in the filtrate as before.

Many chlorides, e.g. silver chloride, many minerals such as apatite, † sodalite, and rocks containing the latter, are not decomposed by boiling them with sodium carbonate. In such cases, the substance must be *fused* with sodium carbonate.

Silver chloride should be mixed with three times as much sodium carbonate and heated in a porcelain crucible until the mass has sintered together. The mass is treated with water, the insoluble silver filtered off, and the chlorine determined in the filtrate as under (a).

For the determination of chlorine in rocks, 1 gm. of the finely-

* Mercurous chloride is decomposed only slowly by sodium carbonate solution, but readily acted upon by potassium or sodium hydroxide.

† According to Jannasch, chlorine in apatite may be determined by treating the finely powdered mineral with nitric acid and silver nitrate on the water-bath. Everything goes into solution with the exception of silver chloride, which is filtered off and weighed. (This does not apply to a sample of apatite contaminated with silica or silicates.)

powdered material is fused with four or five times as much sodium carbonate (or with a mixture of equal parts sodium and potassium carbonates) at first over a Bunsen burner, afterward over a Teclu burner or the blast-lamp. The melt is extracted with hot water. After cooling, methyl orange is added, the solution is acidified with nitric acid and allowed to stand overnight. If silicic acid has precipitated out by the next morning, a little ammonia is added, the solution is boiled, filtered, and washed with hot water. The cold filtrate is acidified with nitric acid and the chlorine determined as above.

If there is no separation of silicic acid on acidifying the water extraction of the fusion with nitric acid,* the chlorine is precipitated at once from the cold solution.

Free Chlorine.

If it is desired to determine gravimetrically the amount of chlorine in a sample of chlorine water, it is not feasible to simply add silver nitrate, for all of the chlorine is not precipitated as silver chloride; a part of it remains in solution as soluble silver chlorate:

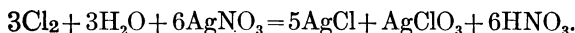

The chlorine, therefore, must be changed to hydrochloric acid or to one of its salts before attempting to precipitate with silver nitrate. This may be accomplished in several ways:

1. A definite amount of the chlorine water is transferred by means of a pipette to a flask containing ammonia and after mixing the solution is heated to boiling. After cooling the liquid is acidified with nitric acid and precipitated by silver nitrate. The ammonia converts the chlorine partly to ammonium chloride and partly to ammonium hypochlorite. The latter is decomposed partly in the cold and quantitatively on warming into ammonium chloride and nitrogen:

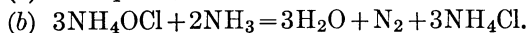

* According to W. F. Hillebrand, there is no separation of silicic acid to be feared from 1 gm. of the substance.

2. The chlorine water is treated with an excess of sulphurous acid, the solution is made ammoniacal, hydrogen peroxide is added, and the liquid boiled until the excess of hydrogen peroxide is removed. After cooling the solution is acidified with nitric acid, diluted with water, and the chlorine precipitated by means of silver nitrate.

3. The chlorine water is treated with dilute caustic soda solution, an aqueous solution of sodium arsenite is added (arsenic trioxide dissolved in sodium carbonate) until a drop of the liquid will not turn a piece of iodo-starch paper blue. It is then acidified with nitric acid and the chlorine precipitated by a soluble silver salt.

If the solution contains both free chlorine and hydrochloric acid, the total chlorine is determined by one of the above methods, while the free chlorine is determined in a separate sample by a volumetric process (see Iodimetry).

Determination of Chlorine in Non-electrolytes (Organic Compounds).

A. Method of Carius.*

Principle.—The method is based upon the fact that all organic compounds are decomposed by heating with concentrated nitric acid at a high temperature under pressure. If the substance contains halogen, sulphur, phosphorus, or arsenic, it is first set free as such, but on account of the reducing action of the nitrous acid formed it is then changed over into its hydrogen compound. The latter, however, is partly oxidized by the nitric acid. The reaction is therefore a reversible one. If, on the other hand, the substance is heated under the same conditions with nitric acid in the presence of silver nitrate, the halogen hydride is converted into silver halide as fast as it is formed and the halogen is in this case quantitatively changed into its silver salt. Sulphur, phosphorus, and arsenic are oxidized in the same way to sulphuric, phosphoric, and arsenic acids and any metals present form nitrates.

* Ann. d. Chem. u. Pharm. (1865), 136, p. 129, and Zeit. f. anal. Chem. 4, p. 451.

Procedure for the Halogen Determination.

A glass tube made of difficultly fusible glass (about 50 cm. long, 2 cm. in diameter, with walls about 2 mm. thick) is sealed at one end, thoroughly cleaned and dried by sucking air through it.

About 0.5 gm. of powdered silver nitrate (or in the case of substances rich in halogen as much as 1 gm. may be used) is transferred to the tube by pouring the powder

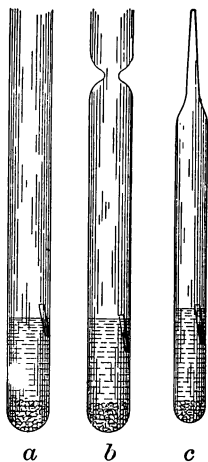

FIG. 53.

through a cylinder made by rolling up a piece of glazed paper and shoving the paper into the tube until it reaches about the middle of it. About 40 c.c. of pure nitric acid (sp. gr. 1.5) free from chlorine are poured into the tube through a funnel whose stem is about 40 cm. long. In this way only the lower half of the tube is wet with the acid. The tube is then inclined to one side and from 0.15–0.2 gm. of the substance contained in a small glass tube closed at one end is introduced into it (this smaller tube should be about 5 cm. long and 5 mm. wide). As soon as the tube containing the substance has reached the acid, it remains suspended (Fig. 53, a). It

is very important that the substance should not come in contact with the acid before the tube is closed at the upper end, as otherwise there is likelihood of some halogen escaping.

The upper end of the tube is now heated very cautiously in the flame of the blast-lamp until the tube begins to soften and thicken (Fig. 53, b). It is then drawn out into a 3–5 cm. long, thick-walled capillary and the end fused together (Fig. 53, c).

After the tube has become cold, it is enveloped in asbestos paper, carefully shoved into the iron mantle of a "bomb furnace," and gradually heated. Aliphatic substances are usually decomposed by heating four hours at 150–200° C; substances of the aromatic series usually require from eight to ten hours' heating at 250–300° C., while in some cases an even longer heating at a higher temperature is necessary. The time and temperature must be

found out for each substance by experiment. The decomposition is complete when on cooling the contents of the tube neither crystals nor drops of oil are to be recognized.* The heating is so regulated that after three hours the temperature of about 200° C. is reached, after three hours more 250–270° C., and finally after another three hours a temperature of about 300° C. is attained.† After the heating is finished, the tube is allowed to cool completely in the furnace, the iron mantle together with the tube is then removed, and by slightly inclining the mantle the capillary of the tube is brought out into the open air. In most cases a drop of liquid will be found in the point of the latter. In order not to lose this, the outer point of the capillary is carefully heated with a free flame, and by this means the liquid is driven back into the other part of the tube. The point of the capillary is now more strongly heated ‡ until the glass softens, when it will be blown out in consequence of the pressure within the tube. The gas escapes with a hissing sound. When the contents of the tube are at the atmospheric pressure, a scratch is made upon it with a file just below the capillary, and this is touched with a hot glass rod, whereby the tube usually breaks and the upper part can be removed. The contents of the tube are then carefully poured into a fairly large beaker without breaking the little tube in which the substance was weighed out, and the inner part of the tube as well as its capillary is washed out with water. The liquid in the beaker is diluted to about 300 c.c. and heated to boiling. After cooling, the insoluble silver halide is filtered off through a Gooch crucible, and after washing and drying at 130° C. its weight is determined.

If it is thought that the precipitate is contaminated by fragments of broken glass, as is often the case even with careful work, the clear liquid is decanted through a filter, the residue washed by

* Sometimes, with substances rich in sulphur, crystals of nitrosyl sulphuric acid are formed and adhere to the sides of the tube. They are easily distinguished from crystals of the undecomposed substance.

† Such a high pressure is often attained that the tube bursts as soon as it is heated very hot. In such cases it should be heated to only 200° C., allowed to cool, the capillary opened and the gas set free. It is then fused together again and heated to the desired temperature.

‡ Before heating, the tube and the hand should be wrapped in a towel to avoid accidents.

decantation with very dilute nitric acid to the disappearance of the silver reaction, and the residue (except when it is silver iodide) is dissolved in warm ammonia water. The solution is filtered through the same filter, but the filtrate is this time collected in a fresh beaker. After washing the filter with dilute ammonia, the filtrate is acidified with nitric acid, heated to boiling, and after allowing the silver chloride or bromide to settle in the dark, it is filtered through a Gooch crucible, dried at 130°C ., and weighed.

In the case of silver iodide, it cannot be dissolved in ammonia and in this way separated from splinters of glass. In this case the substance, together with the glass, is filtered through an ordinary washed filter (not a Gooch crucible), completely washed with dilute nitric acid, then once with alcohol in order to remove the nitric acid, and dried at 100°C . As much of the precipitate as possible is transferred to a watch-glass, the filter burned, and its ash placed in a weighed porcelain crucible. A little dilute nitric acid is added (in order to change any reduced silver into the nitrate), the liquid is evaporated on the water-bath, a few drops of water and a drop of pure hydriodic acid are added, and the contents of the crucible are again evaporated to dryness, when the main part of the precipitate is added, heated until it begins to fuse, and then weighed. The mass in the crucible is then covered with pure dilute sulphuric acid, a piece of chemically pure zinc is added, and the crucible allowed to stand overnight. After this time the silver iodide will be completely reduced to metallic silver. The zinc is removed, and the residue washed by decanting several times with water until the iodine reaction can no longer be detected. The residue is then warmed with dilute nitric acid upon the water-bath, in order to dissolve the silver, the solution is filtered through a small filter; and the latter is washed with water and dried. This filter is ignited in a crucible and the residue (the glass) is weighed. This second weight deducted from the former gives the amount of silver iodide present.

This method is also suitable for obtaining lead and mercury from organic compounds in a form which can be precipitated by hydrogen sulphide.

The method of Carius is by far the best for the determination of halogens in organic substances when only one of the halogens is

present. If two or three of them are present at the same time. the "lime method" is to be preferred.

The Lime Method.

Into a glass tube made of difficultly fusible glass (about 40 cm. long, 1 cm. wide and closed at one end), a layer of lime (free from chloride) from 5 to 6 cm. long is introduced, then about 0.5 gm. of substance, and finally 5 cm. more of lime. The substance is then mixed thoroughly with the lime by means of a copper wire whose end is wound into a spiral. The tube is nearly filled with lime, placed on its side, and gently tapped so that a small canal is formed above the lime. The tube is then placed in a small combustion furnace (cf. Carbon) and heated. First of all the front end of the tube, free from substance, is heated to a dull redness, then the back end, and afterward the other burners are lighted one after another until finally the whole tube is at a dull-red heat. After cooling, the contents of the tube are transferred to a large beaker and the lime dissolved in dilute nitric acid free from chlorine. The carbon is filtered off, and the halogen precipitated with silver nitrate.

If the lime contains calcium sulphate, this is reduced to sulphide, so that some silver sulphide is likely to be precipitated with the silver halide. In this case the solution is treated with hydrogen peroxide (free from halogen) before enough nitric acid has been added to make the solution acid, the liquid is boiled to remove the excess of the reagent, then acidified, filtered, and precipitated with silver nitrate.* In the analysis of substances rich in nitrogen, it is possible that some soluble calcium cyanide will be formed. In this case care must be taken that the silver precipitate contains no silver cyanide (cf. Separation of Cyanogen from Chlorine-Bromine, and Iodine, p. 339).

HYDROBROMIC ACID, HBr. Mol. Wt. 80.93.

Form: **Silver Bromide, AgBr.**

Hydrobromic acid is determined exactly the same as hydrochloric acid. This is also true of the determination of free bromine, and bromine in non-electrolytes.

* W. Biltz (Chem. Ztg., 1903, Rep. 142), separates the halides from sulphide by treating the precipitated silver salts with an ammoniacal sodium thiosulphate solution, whereby the silver halide goes into solution, from which the silver is precipitated as silver sulphide, by adding ammonium sulphide, and determined as silver.

HYDRIODIC ACID, HI. Mol. Wt. 127.93.

Forms: Silver Iodide, AgI, and Palladous Iodide, PdI₂.*(a) Determination as Silver Iodide.*

The determination of hydriodic acid is carried out in exactly the same way as the analysis of hydrochloric acid. If it is desired to filter the silver iodide through an ordinary washed filter instead of through a Gooch crucible, the procedure described on p. 328 is used, converting the reduced metal to iodide by dissolving in nitric acid and adding hydriodic acid. In case there is no hydriodic acid at one's disposal, the main portion of the precipitate is placed in a weighed porcelain crucible and heated until it begins to melt and then weighed. The filter ash is placed in another crucible, and treated with nitric and hydrochloric acids, whereby the silver and any unreduced iodide are changed to silver chloride. The silver chloride is weighed and the equivalent amount of silver iodide is added to the weight of the main part of the precipitate.

Example.—Suppose a grams substance gave p grams silver iodide and p' grams silver chloride, then

$$\begin{aligned} \text{AgCl} : \text{AgI} &= p' : x, \\ x &= \frac{\text{AgI}}{\text{AgCl}} \cdot p'. \end{aligned}$$

We have, therefore, in a grams substance $p + \frac{\text{AgI}}{\text{AgCl}} p'$ grams silver iodide, and the amount of iodine present may be calculated in the usual manner.

(b) Determination as Palladous Iodide.

This important method for the separation of iodine from bromine and chlorine is carried out as follows:

The solution is acidified with hydrochloric acid, and palladous chloride solution is added until no more precipitate is formed. After standing one or two days in a warm place, the brownish-black precipitate of palladous iodide is filtered through a Gooch

crucible, or through a tared filter that has been dried at 100° C., washed with warm water, dried at 100° C., and weighed as PdI₂.

According to Rose, the PdI₂ may be changed to palladium by igniting in a current of hydrogen, and from the weight of the palladium the amount of iodine calculated.

SEPARATION OF THE HALOGENS FROM ONE ANOTHER.

I. Separation of Iodine from Chlorine.

(a) *The Palladous Iodide Method.*

The iodine is determined as above as palladous iodide, and in a second sample the sum of the chlorine and iodine is determined from the weight of their insoluble silver salts.

(b) *Method of Gooch.*

This method depends upon the fact that in a dilute solution of the three halogens, nitrous acid sets free iodine alone:

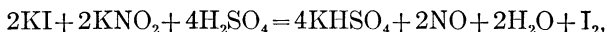

which escapes from the solution on boiling. In one sample, therefore, the halogens are precipitated together in the form of their silver salts, in a second sample the amount of the chlorine is determined after setting free the iodine by means of nitrous acid, and the amount of iodine determined by difference. In order to obtain correct results by this method, the solution must be very dilute when it is boiled to expel the iodine; otherwise some chlorine escapes.

Procedure.—The mixture of the halogen salts (about 0.5 gm. of the substance should be dissolved in 600–700 c.c. water in a liter flask) is treated with 2–3 c.c. of dilute sulphuric acid, 0.5–1 gm. of solid potassium nitrite (free from halogen) is added, and the solution is boiled until entirely colorless; in most cases this is accomplished in about three-quarters of an hour. The contents of the flask are now treated with silver nitrate solution, and the resulting precipitate is allowed to settle. It is filtered through a Gooch crucible, and weighed.

(c) *Method of Jannasch.**

Jannasch proceeds in exactly the same way as Gooch, but instead of letting the iodine escape, he collects in it a mixture of caustic soda and hydrogen peroxide, whereby it is transformed to sodium iodide and is subsequently determined as silver iodide. In the other solution the chlorine is determined in the usual way.

Procedure.—The solution containing the two halogens is placed in a 1½-liter round-bottomed flask and diluted to a volume of 600–700 c.c. Like a wash-bottle, this flask is provided with one glass tube reaching to the bottom, through which vapor can be conducted into the flask, and with another shorter tube for the escape of gas. This second tube is connected with an Erlenmeyer flask for a receiver, and this is in turn connected with a Péligré tube. About 50 c.c. of pure 5 per cent. caustic soda solution are placed in the Erlenmeyer flask, an equal volume of hydrogen peroxide free from chlorine is added, and the mixture cooled by surrounding the flask with ice or snow. The Péligré tube is likewise filled with a suitable amount of caustic soda and hydrogen peroxide. From 5–10 c.c. of dilute sulphuric acid (1:5) and 10 c.c. of 10 per cent. sodium nitrite solution are now added to the solution containing the halogens, the flask is immediately closed, and the contents of the flask are heated over a free flame while water vapor is at the same time conducted into it. As soon as the liquid begins to boil, the space above is filled with violet vapors of iodine, which are gradually driven over into the Erlenmeyer flask, where, with evolution of oxygen, they are completely absorbed by the hydrogen peroxide solution. The iodine is changed into sodium iodide and sodium hypiodite by means of the dilute alkali:



The sodium hypiodite, however, is reduced by the hydrogen peroxide to sodium iodide:

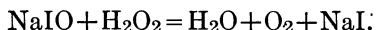

When all the iodine is driven over into the receiver (which is always the case after the solution in the flask has become colorless

* *Zeit. für anorg. Chem.* I, p. 144, and *Prakt. Leit. der Gewichtsanalyse*, p. 182 *et seq.*

and has been boiled for twenty minutes longer), the delivery-tube between the distilling-flask and the Erlenmeyer flask is removed, the liquid within it is washed with hot water into the Erlenmeyer and the current of steam is stopped. The contents of the Pélilot tube are added to the Erlenmeyer flask and the solution heated to boiling in order to remove the excess of hydrogen peroxide. After cooling, the liquid is acidified with a little sulphuric acid; this always causes a yellow coloration due to free iodine.* The solution, therefore, is treated with a few drops of sulphurous acid, whereby it is completely decolorized. An excess of silver nitrate and a little nitric acid are then added, the liquid is boiled, and the silver iodide filtered through a Gooch crucible and weighed.

For the chlorine determination, the contents of the distilling-flask are transferred to a beaker and the chlorine determined as silver chloride.

Remark.—This method has been carefully tested in the author's laboratory by O. Brunner, and in the above form has been found to give very exact results.

Jannasch recommends a slightly different procedure. He adds silver nitrate directly to the alkaline solution in the Erlenmeyer flask. In this way accurate results are obtained provided there is no iodate formed by the absorption of the iodine. In the latter case, due to insufficient cooling of the contents of the receiver, the addition of silver nitrate results in the formation of some silver iodate, and this amount of iodine escapes determination, for silver iodate is soluble (though difficultly so). In such cases the results obtained are too low. If the solution is acidified, however, the presence of the iodate is shown by the separation of a little iodine, and this can be changed by sulphurous acid to iodide, and accurate results will be obtained.

* If the above directions are closely followed, there should not be much separation of iodine. It may be caused by the presence of a small amount of nitrous acid which is not oxidized to nitric acid by hydrogen peroxide; or, if the contents of the Erlenmeyer flask are not kept cool, appreciable amounts of sodium iodate (NaIO_3) are formed, and the latter is not reduced by hydrogen peroxide. In this case there is a separation of a considerable amount of iodine on acidifying the solution, by the addition of sulphurous acid changes it to iodide without loss.

Determination of the Halogens by Indirect Analysis.*(a) Determination of Bromine together with Chlorine.*

Principle.—In this method the sum of the weights of the silver salts of the two halogens is first determined and afterwards the silver bromide converted to silver chloride by heating in a current of chlorine.

Procedure.—The solution containing about 0.5 gm. of the halogen salt is acidified with a little nitric acid (free from chlorine) and precipitated in the cold by the addition of a slight excess of silver nitrate. The liquid is heated to boiling, with frequent stirring, and after cooling again, the precipitate is filtered through a 15 cm. long, asbestos filter-tube made of difficultly fusible glass. The precipitate is dried at 150° C. and weighed after cooling.

For the transformation of the bromide into chloride, the asbestos is shoved forward a little in the tube by means of a glass rod (in order that the gas may pass through it more readily), the tube is fastened in a slightly inclined position, and a current of dry chlorine gas is passed through it. At the same time the tube is heated cautiously by moving a small flame back and forth. During the first half hour the precipitate should not be heated hot enough to melt it; finally, however, the temperature is raised until it *begins* to melt, after which the chlorine is replaced by air, and after cooling the residue is again weighed.

If p represents the combined weight of the two silver salts, and q the weight after the silver has been completely changed to chloride, then

$$\begin{array}{r} \text{AgCl} \quad \text{AgBr} \\ 1. \ x + y = p \\ 2. \ x + my = q \ (\text{AgCl}) \end{array}$$

and from this it follows:

$$3. \ y = \frac{1}{1-m}(p-q).$$

In this equation $m = \frac{\text{AgCl}}{\text{AgBr}} = 0.7633$.

If this value is substituted in equation (3), we obtain

$$(\text{AgBr}) \ y = 4.224 (p-q)$$

and

$$(\text{AgCl}) \quad x = p - y$$

from which the amount of bromine and chlorine may be calculated.

(b) *Determination of Iodine together with Chlorine.*

The same procedure is used as above described

If p represents the weight of silver iodide + silver chloride and q the weight after the silver has been converted to chloride, then

$$\begin{array}{l} \text{AgCl} \quad \text{AgI} \\ 1. \quad x + y = p \\ 2. \quad x + my = q \quad (\text{AgCl}) \end{array}$$

and from this it follows:

$$\begin{array}{l} 3. \quad y = \frac{1}{1-m}(p-q) \\ m = \frac{\text{AgCl}}{\text{AgI}} = 0.6105. \end{array}$$

If this value is substituted in equation (3), we obtain

$$(\text{AgI}) \quad y = 2.567(p - q)$$

and

$$(\text{AgCl}) \quad x = p - y.$$

(c) *Determination of Bromine in the Presence of Iodine.*

In this case p represents the weight of the silver bromide and silver iodide, and q as before the corresponding weight of silver chloride:

$$\begin{array}{l} \text{AgI} \quad \text{AgBr} \\ 1. \quad x + y = p \\ 2. \quad mx + ny = q \quad (\text{AgCl}) \end{array}$$

and

$$3. \quad x = \frac{n}{n-m}p - \frac{1}{n-m}q,$$

in which

$$m = \frac{\text{AgCl}}{\text{AgI}} = 0.6105 \quad \text{and} \quad n = \frac{\text{AgCl}}{\text{AgBr}} = 0.7633.$$

If these values for m and n are substituted in equation (3), we obtain

$$\text{(AgI)} \quad x = 4.996 \cdot p - 6.545 \cdot q$$

and

$$\text{(AgBr)} \quad y = p - x.$$

(d) *Determination of Iodine, Bromine, and Chlorine in the Presence of One Another.*

In one portion of the substance the total weight (P) of the halogen salts is determined, and this is changed over into chloride whose weight (Q) is obtained. In a second portion of the substance, the iodine is determined as palladous iodide, whose weight is (t).

If (t) is multiplied by 1.303, the corresponding weight of silver iodide is obtained (p).

If (p) is subtracted from (P), the sum of the weights of the silver bromide and silver chloride is obtained ($P-p$).

Again, if (t) is multiplied by 0.7951, the corresponding weight of silver chloride is obtained (q), and if this is subtracted from (Q), the amount of silver bromide ($Q-q$) will be obtained which corresponds to the amount that would be obtained from the weight ($P-p$).

If, then, the amount of silver chloride is designated by x and the amount of silver bromide by y , we have:

$$\begin{array}{r} \text{AgCl} \quad \text{AgBr} \\ 1. \quad x + \quad y = (P-p) \\ 2. \quad x + my = (Q-q) \end{array}$$

from which follows from p. 334, (a):

$$3. \quad y = \frac{1}{1-m} [(P-p) - (Q-q)],$$

$$\text{(AgBr)} \quad y = 4.224 [(P-p) - (Q-q)]$$

and

$$\text{(AgCl)} \quad x = (P-p) - y.$$

Instead of determining the iodine as palladous iodide it may be removed as on page 331, *b*, by treatment with nitrous acid and the weight of the silver bromide + silver chloride obtained.

The amount of chlorine, bromine, and iodine follows from the above calculation.

For the determination of bromine and iodine volumetrically consult Part II, Iodimetry.

HYDROCYANIC ACID, HCN. Mol. Wt. 27.02.

Forms: Silver Cyanide, AgCN, and Metallic Silver, Ag.

Free hydrocyanic acid as well as the cyanides of the alkalis and alkaline earths are decomposed quantitatively by silver nitrate with the formation of insoluble silver cyanide.

If, therefore, it is desired to determine gravimetrically the amount of cyanide present in an aqueous solution of hydrocyanic acid or of an alkaline cyanide, the cold solution is treated with an excess of silver nitrate, stirred, a little dilute nitric acid is added, the precipitate allowed to settle and it is then filtered through a weighed filter, dried at 100° C. and weighed. To confirm the result, the silver cyanide is placed in a porcelain crucible, the filter burned in a platinum spiral, its ash added to the main portion of the precipitate, and the contents of the crucible ignited, at first gently and finally until the silver begins to melt; it is then weighed.

By the decomposition of the silver cyanide, difficultly volatile paracyanide is formed, but this is gradually burned away by igniting the contents of the open crucible.

Example: Determination of Hydrocyanic acid in Bitter-almond Water.—Bitter-almond water contains cyanogen as free hydrocyanic acid and as ammonium cyanide, but the greater part is present as mandelic acid nitrile, $C_6H_5CH(OH)CN$. The latter compound is not decomposed in aqueous solution by means of silver nitrate, but is readily acted upon by the latter if the solution is made ammoniacal after the addition of the silver nitrate and then made acid.

The gravimetric determination of the cyanogen present is performed according to the method of Feldhaus* as follows:

100 gms. of bitter-almond water are treated with 10 c.c. of a 10 per cent. silver nitrate solution, 2–3 c.c. of concentrated ammonia

* Z. anal. Chem. III (1864), p. 34.

are added, the solution is immediately acidified with nitric acid, the precipitate allowed to settle, and the HCN determined as described above.

Liebig's volumetric method is much more satisfactory for this determination (see Part II, Precipitation Analyses).

If it is desired to determine the amount of cyanogen in a solid alkali cyanide, a weighed amount of the salt is dissolved in water containing silver nitrate, and the solution then acidified with nitric acid and the precipitate treated as above.

If the cyanide is dissolved in water before the addition of the silver nitrate, there is always a slight loss of hydrocyanic acid.

Some complex cyanides are quantitatively decomposed by silver nitrate, e.g. those of nickel, zinc, and copper (the latter only slowly); while others such as the ferro- and ferricyanides of the alkalis (and mercuric cyanide) are not.

Determination of Cyanogen in Mercuric Cyanide, Method of Rose.

Mercuric cyanide is a non-electrolyte and is consequently not precipitated by silver nitrate, but it is acted upon by hydrogen sulphide with the formation of insoluble mercuric sulphide and hydrocyanic acid:

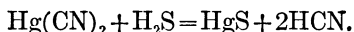

This reaction, however, cannot take place in neutral or acid solutions on account of the volatility of the hydrocyanic acid; it must be performed in an alkaline solution. In order to avoid the introduction of an excess of hydrogen sulphide into the solution, the following procedure is necessary:

The solution of the mercuric cyanide is treated with about twice as much zinc sulphate dissolved in ammonia. If this should cause a turbidity, enough ammonia is added to clear it up and hydrogen sulphide water is then slowly poured in. This causes at first a brown precipitate which becomes black on stirring. The hydrogen sulphide water is added until the upper liquid shows a *pure white* precipitate of zinc sulphide. The zinc sulphate, therefore, serves, as it were, as an indicator, inasmuch as the pure white precipitate will not be formed until the mercury is completely precipitated. The precipitated sulphides are now

filtered off and washed with dilute ammonia. The filtrate contains all of the hydrocyanic acid and is treated with an excess of silver nitrate, acidified with nitric acid filtered and the weight of the silver cyanide determined as described on page 337.

Determination of Hydrocyanic Acid and Halogen Hydride in the Presence of One Another, according to Neubauer and Kerner.*

The solution is treated with silver nitrate in the cold, the precipitate filtered, dried at 100° C. and in this way the total weight of the silver salts is determined. A definite amount of the precipitate is placed in a porcelain crucible, heated until it is completely melted, and then reduced with zinc and sulphuric acid as described on page 328. The metallic silver and paracyanogen are filtered off and the halogen determined in the filtrate according to page 320 et seq.

The above separation can be more satisfactorily effected by means of a volumetric process (See Precipitation Analyses).

SULPHOCYANIC ACID, HCNS. Mol. Wt. 59.09.

Forms: $\text{Cu}_2(\text{CNS})_2$, $\text{Ag}(\text{CNS})$, BaSO_4 .

i. Determination as Cuprous Sulphocyanate, $\text{Cu}_2(\text{CNS})_2$.

The solution of the alkali sulphocyanate, which is neutral or slightly acid with hydrochloric or sulphuric acid, is treated with 20 to 50 c.c. of a saturated solution of sulphurous acid, and copper sulphate solution is introduced with constant stirring until a slightly greenish tint is imparted to the liquid. After standing a few hours, the precipitate is filtered into a Munroe crucible, washed with cold water containing sulphurous acid, then once with alcohol, and dried at 130° to 140° to constant weight. The results are good.

* Ann. d. Chem. u. Pharm. (1857), 101, p. 344.

2. Determination as Silver Sulphocyanate, Ag(CNS).

This excellent method for estimating sulphocyanic acid is only applicable in the absence of the halogen acids, or hydrocyanic acid.

The dilute solution of the alkali sulphocyanate is treated in the cold with a slight excess of silver nitrate solution, which has been slightly acidified with nitric acid. After stirring well, the precipitate is filtered into a Munroe crucible, washed with water, then with a little alcohol, dried at 130° to 150° and weighed.

R. Philipp obtained good results by this method.

3. Determination as Barium Sulphate.

In the absence of all other compounds containing sulphur, thiocyanic acid may be determined with accuracy by oxidizing it and precipitating the sulphuric acid formed as barium sulphate. Bromine water is the most suitable oxidizing agent for this purpose. The alkali sulphocyanate solution is treated with an excess of bromine water, heated for from thirty minutes to an hour on the water-bath, the solution acidified with hydrochloric acid, and the sulphuric acid precipitated (according to the directions on p. 464 et seq.) by means of barium chloride, and weighed as barium sulphate.

Instead of bromine, nitric acid may be employed as the oxidizing agent.

It will not do at all, however, to treat a solid alkali sulphocyanate with strong nitric acid in an open vessel, for on account of the violent action some of the hydrocyanic acid is volatilized and escapes oxidation. It is better, as E. Heberlein found in the author's laboratory, to dissolve the alkali sulphocyanate in water (Heberlein used 20 c.c. of a one-tenth normal potassium sulphocyanide solution) and add 10 c.c. of fuming nitric acid, keeping the beaker surrounded with ice. The solution is at first colored yellow, then deep red, reddish brown, and finally becomes colorless. The sulphur is then by no means entirely oxidized to sulphuric acid; to accomplish this the solution must be kept boiling gently

for two hours. It is then evaporated almost to dryness, taken up in 200 c.c. of water, precipitated hot with barium chloride solution and the barium sulphate filtered off and weighed. Heberlein found 99.79—99.94 per cent. of the potassium sulphocyanate taken. The oxidation is more certain, if the solution of the alkali sulphocyanate is placed in a flask connected with a return-flow condenser, treated with an excess of fuming nitric acid, boiled two hours and then treated as above. In this way Heberlein found 100.1 and 100.2 per cent. of the theoretical amount of sulphocyanic acid. The oxidation of the sulphocyanic acid is still better effected by first precipitating the acid in the form of its silver salt* and filtering it off (it is only necessary to wash the precipitate when a sulphate is also present). The funnel containing the precipitate is then placed over a small flask, the apex of the filter is broken with a glass rod and the precipitate washed into the flask by means of a stream of nitric acid (sp. gr. 1.37–1.40). In this way there is no violent reaction and no loss of sulphocyanic acid to be feared. The contents of the flask are heated to boiling for three-quarters of an hour. If at the end of this time, red vapors are still evolved from the flask (usually due to small particles of filter paper) it makes no difference; the oxidation of the sulphocyanic acid is sure to have been complete. The contents of the flask are evaporated to a small volume in order to remove the excess of nitric acid, taken up with water and the silver precipitated as chloride and filtered off. The sulphuric acid is precipitated in the filtrate as barium sulphate and the latter is weighed.†

Hydrogen peroxide in ammoniacal solution also oxidizes sulphocyanic acid completely to sulphuric acid but the oxidation requires more time than in the case of nitric acid. By this method, according to Heberlein, the alkali sulphocyanate is treated with a large excess of 3 to 4 per cent. hydrogen peroxide (for 20 c.c. of one-tenth normal sulphocyanate solution, 120 c.c. of 3 to 4 per cent. hydrogen peroxide are used), the solution made ammoniacal, allowed to stand twenty-four hours at the ordinary temperature, then heated two hours on the water-bath, and finally boiled. After acidifying with

* W. Borchers, *Repertorium der anal. Chemie*, 1881, p. 130.

† Borchers precipitates the sulphuric acid without removing the silver by means of barium nitrate. The procedure given here is better.

hydrochloric acid the sulphuric acid is precipitated with barium chloride and the barium sulphate formed is weighed.

The oxidation is effected even more slowly by potassium percarbonate.

Determination of Sulphocyanic and Hydrocyanic Acids in the Presence of One Another (Borchers).*

The amount of silver nitrate necessary to precipitate both of the acids is determined volumetrically in one sample of the substance (see Precipitation Analysis) and in a second portion the weight of the barium sulphate formed after the oxidation of the sulphocyanic acid is determined. From the latter weight the amount of sulphocyanic acid present can be computed and also the amount of silver nitrate that would be required to precipitate it. If this amount is subtracted from the amount of silver nitrate required to precipitate both of the acids, the amount of silver nitrate equivalent to the hydrocyanic acid present is obtained.

Determination of Sulphocyanic Acid together with Halogen Hydrides (Volhard).

In one portion the amount of sulphocyanic acid present is determined as barium sulphate after oxidation with nitric acid. A second portion is heated in a closed tube with concentrated nitric acid and silver nitrate (Carius Method, † page 325) after which the halogen silver salts are filtered off, weighed, and subsequently changed to silver chloride as described on page 334. A third portion is fused with sodium carbonate and potassium nitrate and the iodine determined from the melt as palladous iodide (see page 330). From the data thus obtained, the three halogens are computed (see page 336).

HYDROFERROCYANIC ACID, $H_4Fe(CN)_6$. Mol. Wt. 215.9.

Form: Silver Cyanide, $AgCN$.

The most accurate procedure for the analysis of cyanides is to determine the carbon and nitrogen by elementary analysis (which see).

* *Loc. cit.*

† Instead of using the Carius method, the halogens and sulphocyanide may be precipitated by silver nitrate, filtered through a Gooch crucible, dried at 160° and weighed.

Determination as Silver Cyanide (Rose-Finkener).

This method depends upon the fact that all salts of hydroferrocyanic acid on being heated with yellow mercuric oxide give up their cyanogen to the mercury, forming soluble mercuric cyanide, while the iron is changed to insoluble ferric hydroxide. Thus Prussian blue is decomposed as follows:

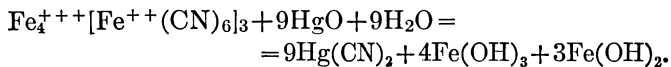

A weighed amount of the substance is treated with an excess of mercuric oxide and the liquid is boiled until the blue color has completely disappeared, when the precipitate is filtered off.

On filtering off the insoluble oxides, at first a clear filtrate is obtained, but on washing some of the precipitate usually passes through the filter. By washing with a solution containing a dissolved salt, preferably mercuric nitrate, it is possible to obtain, however, a clear filtrate. Even then the operation is tedious, so that the attempt has been made to avoid the washing of the precipitate by diluting the liquid containing the precipitate suspended in it to a definite volume, filtering through a dry filter, measuring off a definite volume of the filtrate, and subsequently determining the cyanogen as silver cyanide after first precipitating out the mercury as sulphide (see p. 338). The amount of cyanide found is then calculated over into the amount that would have been obtained in case the whole of the solution had been used for the analysis. In this way an error is introduced which in some cases is considerable. Let us assume that the Prussian blue was decomposed in a 100-c.c. flask and after the decomposition was complete, the liquid was diluted up to the mark; and that in 50 c.c. of the filtrate p gms. of cyanide were found.

The amount of cyanide in the portion weighed out is not 2 p gms., for the volume of the liquid before filtering was not 100 c.c., but $100-v$ c.c., where v is the volume of the suspended oxides. This volume v can be determined only approximately, so that the cyanogen determination by this method will never be absolutely certain. In order to obtain exact results, the first-mentioned procedure should be followed; or, better still, the amount

of carbon and nitrogen should be determined by elementary analysis.

Soluble ferrocyanides may be satisfactorily determined by titration with potassium permanganate (cf. Part II, Oxidation and Reduction Methods). For the determination of the iron and other metals, the substance is heated with concentrated sulphuric acid, the residue after evaporation is dissolved in water, and the solution analyzed as usual.

HYDROFERRICYANIC ACID, $H_3[Fe(CN)_6]$. Mol. Wt. 214.9.

The ferricyanides are analyzed in the same way as the ferrocyanides.

HYPOCHLOROUS ACID, $HClO$. Mol. Wt. 52.47.

Hypochlorous acid is always determined volumetrically and will be discussed in Part II of this book, under Oxidation Methods.

GROUP II.

NITROUS, HYDROSULPHURIC, ACETIC, CYANIC, AND HYPOPHOSPHOROUS ACIDS.

NITROUS ACID, HNO_2 . Mol. Wt. 47.02.

Nitrous acid is either determined volumetrically, gasometrically, or colorimetrically. The two former methods will be discussed in Parts II and III of the book.

Colorimetric Determination, of Peter Griess.

This method serves only for the determination of extremely small amounts of nitrous acid (e.g., in drinking-waters), and depends upon the formation of intensively colored azo-dyes.

Inasmuch as azo-compounds are formed only when nitrous acid is present, they can all be used in testing for this acid, but the different substances do not prove equally sensitive as reagents. Thus in the production of tri-amido-azo-benzene (Bismarck brown) not less than $\frac{2}{1000}$ mgm. of nitrous acid in a liter can be detected, while according to the following procedure $\frac{1}{1000}$ mgm. in a liter can be detected with certainty. To carry out the determination two solutions are necessary, one of sulphanilic acid and one of

α -naphthylamine. Both substances are dissolved in acetic acid* and prepared according to the directions of Ilosvay † as follows:

1. 0.5 gm. of sulphanilic acid is dissolved in 150 c.c. of dilute acetic acid.

2. 0.1 gm. of solid α -naphthylamine is boiled with 20 c.c. of water, the colorless solution is poured off from the bluish-violet residue, and 150 c.c. of dilute acetic acid are added.

These two solutions are now mixed.‡ It is not necessary to protect the reagent from the action of light, but it is desirable to keep impure air away from it. As long as the solution remains colorless it can be used. If it comes in contact with nitrous acid, which is often present in the air, the reagent becomes red, and in this case it must be decolorized by shaking with zinc-dust before using.

Besides the above reagent, it is necessary to prepare a solution of sodium nitrite of known strength. For this purpose a concentrated solution of commercial potassium nitrite is treated with silver nitrate solution, the precipitated silver nitrite is filtered off and washed a few times with cold water. In order to obtain absolutely pure silver nitrite the precipitate is dissolved in as little hot water as possible and quickly cooled. The mass of crystals is placed in a funnel provided with a platinum cone, and after being sucked free from mother-liquor, it is washed with a small amount of distilled water. The silver nitrite is placed in a calcium chloride desiccator and allowed to dry in the dark. As soon as it has become dry (shown by its having assumed a constant weight) exactly 0.4047 gm. of it is weighed out into a liter flask and dissolved in hot distilled water. About 0.2 to 0.3 gm. of pure sodium chloride is added (i.e., a little more than the theoretical amount) in order to convert the silver nitrite into silver chloride and sodium nitrite. After becoming cold, the solution is diluted to exactly one liter with pure water, then thoroughly shaken, and the precipitate allowed to settle. After this, 100 c.c. of the clear liquid are pipetted into a second

* P. Griess used dilute sulphuric acid to set free the nitrous acid. Ilosvay showed that if acetic acid were used the reaction was much more sensitive.

† Bull. chim. [2] 2, p. 317.

‡ Lunge, Zeitschr. f. angew. Chem. 1899, Heft 23.

liter flask and diluted up to the mark with water free from nitrous acid. 1 c.c. of this solution contains 0.01 mgm. N_2O_3 .

Procedure for the Determination.

50 c.c. of the water to be examined are placed in a cylinder, such as is shown on p. 61, treated with 5 c.c. of the reagent, and the contents of the cylinder mixed with the aid of the stirrer shown in Fig. 25; the cylinder is placed in water at about 70–80° C. If as much as $\frac{1}{1000}$ mgm. of nitrous acid is present in a liter of the water tested, the red coloration will appear within one minute; with relatively larger amounts (e.g., as much as 1 mgm. per liter) the solution is simply colored yellow, unless a concentrated solution of naphthylamine is used. Meanwhile in three other cylinders are placed respectively 0.1 c.c., 0.5 c.c., and 1 c.c. of the solution containing a known amount of sodium nitrite; each is diluted with water up to the mark and treated with the reagent in the same way. As soon as a distinct red coloration is apparent, the colors are compared with that produced by the water to be analyzed. If the color of the unknown water lies between two of the standards—e.g., between that produced with 0.1 and 0.5 c.c. of the standard—then three more standards are prepared containing, say, 0.2, 0.3, and 0.4 c.c. of the known solution. When the color of the unknown solution is matched, then the water contains the same amount of nitrous acid as the standard.

If the water contains considerable nitrous acid (e.g., over 0.3 mgm. per liter), then the red coloration will be so dark that the colorimetric determination cannot be performed with certainty. In this case a definite volume of the water is diluted with distilled water and the nitrous acid present in this diluted water is determined as before.

Tromsdorff recommends for the determination of nitrous acid in drinking-water the use of zinc iodide of starch, and comparing the blue color produced by the nitrous acid (cf. Vol. I, p. 332). If $\frac{1}{10}$ mgm. of nitrous acid is present in a liter, the blue color produced can be distinctly seen; with $\frac{1}{100}$ mgm. per liter, however, the color is so intense that it is unsuitable for a colorimetric determination. This method is not to be recommended because in the first place

it is far less sensitive than the Griess method, and second because it can easily lead to error inasmuch as a blue color will be often produced when there is no nitrous acid present. Traces of hydrogen peroxide or ferric salts, which are likely to be present in a drinking-water, will also cause the solution of zinc iodide of starch to turn blue.

HYDROSULPHURIC ACID, H_2S . Mol. Wt. 34.09.

Forms: Barium Sulphate, $BaSO_4$, Hydrogen Sulphide, H_2S , and colorimetrically.

There are four cases to be considered:

- I. The determination of free hydrogen sulphide.
- II. The determination of sulphur in sulphides soluble in water.
- III. The determination of sulphur in sulphides insoluble in water but decomposable by dilute acids with evolution of hydrogen sulphide.
- IV. The determination of sulphur in insoluble sulphides.

I. Determination of Free Hydrogen Sulphide.

(a) *Determination of Hydrogen Sulphide in Gas Mixtures.*

In case it is desired to know the per cent. of hydrogen sulphide present in a mixture of gases, the analysis is best made volumetrically (see Part II, Iodometry), but it is possible to accomplish the same end by a gravimetric process.

The source of the gas is connected by means of rubber tubing with the ten-bulb absorption-tube shown in Fig. 55, page 359,* which contains a solution of ammoniacal hydrogen peroxide free from sulphuric acid. The other end of the absorption-tube is connected with an aspirator, i.e. a large bottle of about 4-5 liters capacity filled with water and closed by means of a double-bored stopper. Through one hole of the stopper is passed a right-angled glass tube which reaches just below the bottom of the stopper in the bottle, and its other end is connected with the absorption-tube. Through the other hole in the stopper is placed a glass tube reaching to the bottom

* Usually two of these tubes are used in order to make sure that none of the gas escapes absorption.

of the bottle. The upper end of this tube is likewise bent, and is connected with a rubber tube to serve as a siphon; on the lower end of the rubber tube is a screw-cock.

Before beginning the experiment, the air in the rubber tubing between the source of gas and the absorption-tube is removed by conducting the gas to be analyzed through it. When this is accomplished the tubing is connected with the absorption-tube. Water is now allowed to run slowly from the aspirator into a vessel graduated in liters; after from 2-5 liters of the water have run out, the aspirator is closed by screwing up the cock on the siphon arm. The contents of the absorption-tube are poured into a beaker, slowly heated to boiling, and kept at this temperature for from five to ten minutes. The solution is then evaporated on the water-bath to a small volume, a little hydrochloric acid is added, the solution filtered if necessary, and the sulphuric acid precipitated at a boiling temperature with a boiling solution of barium chloride. After the precipitate has settled, it is filtered off, ignited wet in a platinum crucible, and weighed as barium sulphate.

Both at the beginning and end of the experiment it is necessary to note the temperature of the room and the barometer reading. The mean of these readings is used for the calculation. The amount of hydrogen sulphide present in the gas is computed as follows:

The volume of water which has flowed out of the aspirator represents the volume of the gas that has been sucked through the apparatus less the amount absorbed by the ammoniacal hydrogen peroxide solution. Let V represent the volume of water in liters which has flown from the aspirator and p the weight of barium sulphate found.

Since one gram molecule of barium sulphate corresponds to one gram molecule of hydrogen sulphide and the latter assumes at 0° C. and 760 mm. pressure a volume of 22.159 liters,* we have:

$$\text{BaSO}_4 : 22.159 : p : V_1;$$

$$V_1 = \frac{22.159 \cdot p}{\text{BaSO}_4} = \text{the volume of the hydrogen sulphide absorbed.}$$

* According to Leduc, *Comptes rendus*, **125**, 571 (1897) the density of H₂S (referred to air=1) is 1.1895, from which the molecular volume is computed as 22.159 liters.

Now the volume (V) of the gas that passed through the apparatus was at t° and B mm. pressure, while V_1 is measured at 0° C. and 760 mm. pressure. It is necessary, therefore, to reduce V to 0° C. and 760 mm. pressure.

$$V_0 = \frac{V \cdot (B - w) 273}{760(273 + t)}.$$

The volume of the gas drawn through the apparatus is then:

$$V_0 + V_1;$$

and we have:

$$(V_0 + V_1) : V_1 = 100 : x,$$

$$x = \frac{V_1 \cdot 100}{V_0 + V_1} = \text{the per cent. by volume of hydrogen sulphide present.}$$

(b) *Determination of the Amount of Hydrogen Sulphide Present in Solution.*

By means of a pipette a definite volume of the solution is measured out and allowed to run into ammoniacal hydrogen peroxide with constant stirring of the latter by means of the pipette itself. After heating to boiling and acidifying with hydrochloric acid, the amount of sulphuric acid formed is determined as barium sulphate.

II. Determination of Sulphur in Sulphides Soluble in Water.

(α) The solution is treated with an excess of ammoniacal hydrogen peroxide water, slowly heated to boiling and kept at that temperature until the excess of the reagent is destroyed, when the sulphuric acid is precipitated with barium chloride and weighed as barium sulphate.

(β) The solution is treated with bromine water until a permanent brown color is obtained, when it is warmed, acidified with hydrochloric acid, and the sulphuric acid determined as barium sulphate.

If the solution contains thiosulphate, sulphide, and sulphate, as is likely to be the case after standing in the air for some time, the sulphide sulphur is precipitated by means of cadmium acetate and the sulphur in the precipitate is determined as under III, or the cadmium sulphide is oxidized with either bromine water or

fuming nitric acid, and the sulphuric acid formed determined as barium sulphate.

The determination of thiosulphate, sulphide, and sulphite sulphur will be discussed in Part II of this book under Iodimetry.

III. The Determination of Sulphur in Sulphides Soluble in Dilute Acids.

Principle.—The hydrogen sulphide is evolved by treatment of the sulphide with dilute acids, and absorbed in ammoniacal hydrogen peroxide solution as under I; or the hydrogen sulphide is absorbed in caustic soda solution and the sodium sulphide formed analyzed according to II; or finally the gas may be absorbed in a weighed tube containing pumice soaked with copper sulphate solution, in which case the gain in weight represents the amount of gas absorbed.

Evolution and Absorption of the Hydrogen Sulphide.

In the case of sulphides rich in sulphur 0.25–0.50 gm. of the substance should be taken for the analysis, whereas of those containing less sulphur a correspondingly larger amount should be taken. The substance is placed in an Erlenmeyer flask (Fig. 54, *a*) the connection between the flask and the receiver is broken and the air is expelled from *K* by conducting hydrogen gas through the delivery tube and out through the open stop-cock of *T*. After a rapid current of hydrogen has passed through the apparatus for about five minutes, the receivers *V* and *P* are partly filled with an ammoniacal solution of hydrogen peroxide* (about 3–4 per cent. H_2O_2); placing about 100 c.c. of the solution in *V* and about 10–20 c.c. in *P*.

The receiver, *V*, is now connected with the delivery-tube from the evolution-flask *K*, and hydrogen is conducted from *T* throughout the whole apparatus for five minutes more in order to remove as

* In case hydrogen peroxide is not at hand, the receivers should contain 100 c.c. of dilute sodium hydroxide solution (250 gm. to 1 liter). After the decomposition is complete the contents of the receiver are transferred to a beaker, 30–50 c.c. of bromine water are added, the solution acidified with hydrochloric acid (sp. gr. 1.19) and boiled while carbon dioxide is passed through it until the excess of bromine is completely expelled. The sulphuric acid formed is then precipitated with a hot solution of barium chloride. Instead of oxidizing the sodium sulphide to sodium sulphate it can be titrated with iodine (cf. Iodimetry).

much as possible of the air from the receivers. After this, about 20 c.c. of boiled water are introduced into *K* through *T* so that the substance is entirely covered, then dilute hydrochloric acid (1 vol. concentrated acid + 1 vol. of boiled water) is slowly added to the contents of the flask and the decomposition is promoted by warm-

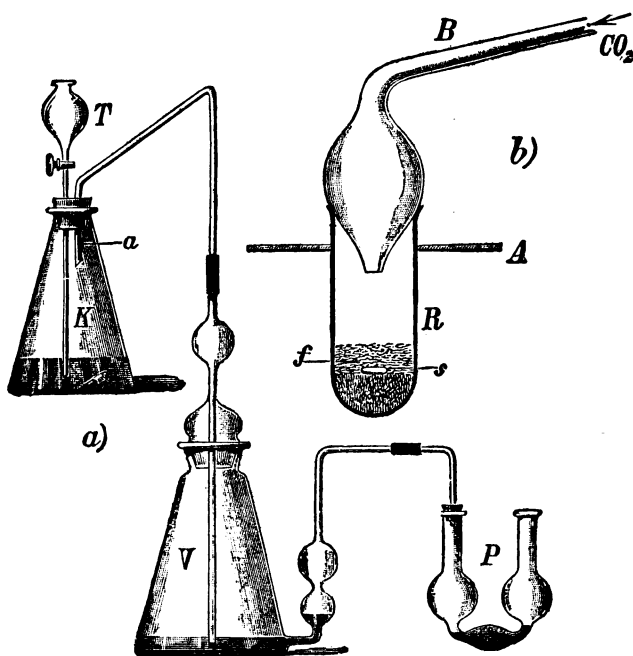

FIG. 54.

ing somewhat. When the evolution of the gas has ceased, the contents of *K* are heated to a gentle boiling and a slow current of hydrogen* is conducted through the apparatus from *T* for twenty minutes, when the flame is removed and the current of hydrogen is continued for fifteen minutes longer. At the end of this time, the hydrogen sulphide will surely completely be driven over into *V*.†

* The hydrogen is evolved from zinc and sulphuric acid in a Kipp generator. The gas is washed first with an alkaline lead solution in order to remove traces of hydrogen sulphide and then with water.

† By the absorption of the hydrogen sulphide in the ammoniacal solution

The contents of the two receivers are washed into a beaker and slowly heated to boiling in order to effect the complete oxidation of the thiosulphuric and sulphurous acids and to expel the excess of the hydrogen peroxide. The solution is finally acidified with hydrochloric acid and the sulphuric acid determined as barium sulphate.

This method yields excellent results and can be applied to the

Determination of Sulphur in Iron and Steel.

Inasmuch as the amount of sulphur present is so small, a large amount of the substance must be taken for the analysis. For pig iron 2-5 gms. are sufficient, while with steel 5 gms., and with wrought iron, as much as 10 gms. should be used.

The determination is carried out in the same way as before, except in this case a stronger acid should be used (HCl sp. gr. 1.19); this is allowed to act upon the iron at once without first covering it with water, and the boiling is continued for at least twenty minutes after the gas evolution has ceased.

Instead of collecting the evolved hydrogen sulphide in ammoniacal hydrogen peroxide, it is often more convenient to absorb it in ammoniacal cadmium solution, or in caustic soda solution, and determine the sulphur volumetrically by an iodimetric process. See Appendix I.

Remark.—The sulphur present in steel or cast iron made by the Thomas-Gilchrist, or basic Bessemer, process can as a rule be determined accurately by this method. In the case of certain other steels and cast irons, however, the results are likely to be low. In order to carry out an accurate determination in such cases, a tube made of difficultly fusible glass (about 30 cm. long and 1 cm. wide) is inserted between the evolution flask *K* and the absorption flask *V* (Fig. 54). After the air has been replaced by

of hydrogen peroxide the latter is always colored somewhat yellow owing to the formation of a little ammonium disulphide. This yellow color can be distinctly seen in the delivery-tube, where it dips into the solution in the receiver and later disappears owing to further oxidation:

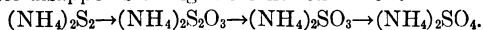

When the color can no longer be detected, it is a sign that the greater part of the hydrogen sulphide has been driven over.

hydrogen, this tube is heated to dark redness by means of a small furnace of from four to six burners, whereby the sulphur in the methyl sulphide passing through the tube is converted completely into hydrogen sulphide.

When the use of this tube is adopted, care must be taken that no drops of water enter the red-hot tube. To this end, the liquid in the flask *K* should only be boiled very gently, or better, the flask should be connected with a return flow condenser. (Cf. p. 381.)

The insoluble residue which is obtained especially in the case of irons containing considerable silicon, often contains an appreciable amount of sulphur. The residue is, therefore, filtered off, washed, dried, fused with sodium carbonate and potassium nitrate (cf. p. 357), the melt extracted with water, the resulting solution evaporated with hydrochloric acid, any deposited silicic acid filtered off, and the sulphuric acid in the final filtrate determined as barium sulphate in the usual way.

Phillips and Blair have shown* that sulphur present in different kinds of iron and steel, especially cast iron, may be present in four different conditions:

1. By far the greater part is evolved as hydrogen sulphide when the metal is treated with hydrochloric acid.

2. Another part is evolved probably as methyl sulphide $(\text{CH}_3)_2\text{S}$, an extremely stable sulphur compound which is not very much affected by ammoniacal hydrogen peroxide, bromine in hydrochloric acid, or aqua regia. The sulphur in this compound is changed completely into hydrogen sulphide on being passed through a tube heated to redness, in which hydrogen is also present.

3. Another part of the sulphur present is not volatilized by the action of hot dilute hydrochloric acid, but can be oxidized to sulphuric acid by treating the contents of the evolution flask with nitric acid or aqua regia.

4. Another very small part of the sulphur may be present in the form of an insoluble sulphide which is not oxidized by nitric acid or aqua regia and can only be obtained in solution after fusion with sodium carbonate and potassium nitrate.

More recent work† has shown, however, that annealing the

* Cf. J. Am. Chem. Soc., **19**, 114 (1897).

† T. G. Elliott, Chem. News, **104**, 298 (1911), mixes 5 gms. of the iron or

sample converts all the sulphur into a condition such that it is evolved as hydrogen sulphide when the metal is treated with hydrochloric acid, sp. gr. 1.19.

Bamber Method for Determining Sulphur in Iron and Steel.

On account of the uncertainty in obtaining all the sulphur present in iron or steel by the above evolution method, the Committee on Standard Methods for the Analysis of Iron—American Foundrymen's Association, have recommended the following method, which is that proposed by Bamber.

A 3-gm. sample of drillings is dissolved in concentrated nitric acid. After the iron is completely dissolved, 2 gms. of potassium nitrate are added, the solution is evaporated to dryness in a platinum dish and the dry residue is ignited over an alcohol lamp at a red heat. After the ignition, 50 c.c. of a 1 per cent. solution of sodium carbonate are added, the liquid boiled for a few minutes, and then filtered, washing the precipitate with hot 1 per cent. sodium carbonate solution. The filtrate containing all the sulphur is evaporated to dryness with hydrochloric acid, the residue thus obtained is taken up in 50 c.c. of water and 2 c.c. of concentrated hydrochloric acid, and the resulting solution is filtered. The filtrate is diluted to a volume of about 100 c.c. and precipitated hot with barium chloride solution.

During the determination great care should be taken to prevent the absorption of fumes containing sulphur. For this reason a gas flame should not be used at any stage in the process.

Colorimetric Determination of Sulphur in Iron and Steel.*

Principle.—The hydrogen sulphide evolved from a weighed amount of iron is passed through a cloth which has been wet with a solution of cadmium acetate. The hydrogen sulphide reacts with the cadmium salt to form yellow cadmium sulphide and the intensity of the color is proportional to the amount of hydrogen sulphide.

If a grams of substance produce a certain shade then it would take $2a$ grams of a substance containing half as much sulphur to

steel with 0.25 gm. of anhydrous potassium ferrocyanide, wraps the mixture in filter paper, places it in a porcelain crucible, and anneals at 750°–850° for 20 minutes in a muffle furnace.

* J. Wiborgh; Stahl and Eisen, 6 (1866), p. 240.

duplicate it, or in other words, the relations hold, $as = a's'$, where a and a' represent the amount of substance taken for the analysis and s and s' the percentage of sulphur present. In the first place, then, a scale must be prepared of different shades representing different percentages of sulphur. For this purpose, Wiborgh uses the apparatus shown in Fig. 55. It consists of a 250–300-c.c.

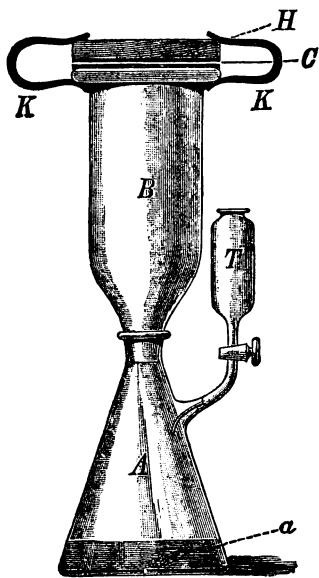

FIG. 55.

Erlenmeyer flask A with a side-arm funnel T and with a ground-glass connection between the cylinder B . The latter is about 20 cm. long, and is from 5.5–6.0 cm. wide at the top and about 8 mm. at the bottom. The upper edge of the cylinder is rounded over and ground perfectly smooth. Upon this upper edge are placed two rubber rings of the same inner diameter as the glass cylinder. Between these two rings is laid a circular piece of cloth C that has been dipped in a solution of cadmium acetate, and upon the upper rubber ring is placed a wooden ring H which is held firmly against the edge of the cylinder by means of three clamps K (only two are shown in the illustration).

The flask A is filled not quite half full with distilled water, the contents boiled a few minutes to remove the air, the flame is removed, and a weighing-tube containing a definite amount of a sample whose sulphur content is known is thrown into the flask. The cylinder, with the cadmium acetate cloth in position, is placed upon the flask, and the gentle boiling is continued until the cloth is uniformly moistened with the aqueous vapor which is seen to pass through it. The water must not be boiled too strongly and the cloth must not be allowed to puff up, for in that case it will become distorted and afterward an unevenly colored surface will be obtained. After boiling for three or four minutes sulphuric acid (1:5) is cautiously added, drop by drop, to the contents of the flask (3 c.c. for each 0.1 gm. of iron) through the

funnel *T*. The evolution of hydrogen sulphide begins at once and is recognized by the cadmium acetate cloth becoming yellow. After the acid has all been added, the boiling is continued until there is no more gas evolved from the substance, and then for ten minutes more in order to completely expel it from the solution.

The piece of cloth is now removed and placed upon a piece of white filter-paper, so that the side which was toward the flask is on top. In the same way a scale of six different shades is prepared corresponding to the following table:

Tint No. 1.		Tint No. 4.	
Amount Weighed Out.	Per Cent. Sulphur Present.	Amount Weighed Out.	Per Cent. Sulphur Present.
0.8	0.0025	0.8	0.015
0.4	0.005	0.4	0.030
0.2	0.010	0.2	0.060
0.1	0.020	0.1	0.120
0.08	0.025	0.08	0.150
0.04	0.050	0.04	0.300
0.02	0.100	0.02	0.600
Tint No. 2.		Tint No. 5.	
0.8	0.005	0.8	0.025
0.4	0.010	0.4	0.050
0.2	0.020	0.2	0.100
0.1	0.040	0.1	0.200
0.08	0.050	0.08	0.250
0.04	0.100	0.04	0.500
0.02	0.200	0.02	1.000
Tint No. 3.		Tint No. 6.	
0.8	0.01	0.8	0.035
0.4	0.02	0.4	0.070
0.2	0.04	0.2	0.140
0.1	0.08	0.1	0.280
0.08	0.10	0.08	0.350
0.04	0.20	0.04	0.700
0.02	0.40	0.02	1.400

To illustrate the use of this table, suppose we wish to prepare the scale from a sample of steel containing exactly 0.17 per cent. of sulphur. How much of it should be weighed out in order to prepare Tint No. 1?

From the table we know that this shade can be prepared by

weighing out 0.8 gm. of an iron containing 0.0025 per cent. sulphur, and it follows from what has been said:

$$0.8 \times 0.0025 = x \times 0.017$$

$$x = \frac{0.8 \times 0.0025}{0.017} = 0.0118 \text{ gm.}$$

We must, therefore, weigh out 0.0118 gm. of the steel in order to prepare Tint No. 1.

In the same way the amount necessary to produce Tint No. 2 will be found to be 0.0235 gm., etc. For the determination proper, from 0.1–0.8 gm. of the substance (according to its supposed sulphur content) is weighed out and treated in the same way. If with a sample of 0.2 gm. a shade corresponding to Tint No. 5 is obtained, the table shows us that 0.1 per cent. of sulphur is present.

Remark.—The above process is very simple and to be recommended in case a large number of sulphur determinations are to be made, as is the case in iron and steel laboratories. It is to be noted, however, that an accurate value is obtained only when all the sulphur is present in a form such that it is evolved as hydrogen sulphide on treatment with acid.

IV. Determination of Sulphur in Insoluble Sulphides.

For this analysis the sulphur is either oxidized to sulphuric acid and determined as barium sulphate, or the sulphide is acted upon in a suitable apparatus with nascent hydrogen, whereby the sulphur is evolved as hydrogen sulphide and is absorbed by one of the above-described methods.

The oxidation of the sulphide can take place:

- (a) *In the Dry Way.*
- (b) *In the Wet Way.*

(A) OXIDATION IN THE DRY WAY.

1. *Fresenius' Method: Fusion with Sodium Carbonate and Potassium Nitrate.*

About 0.5 gm. of the finely powdered sulphide is intimately mixed in a spacious nickel crucible with twelve times as much of a mixture of four parts sodium carbonate and one part

potassium nitrate,* covered with a thin layer of the mixture and heated at first gently, then gradually increasing the temperature until the contents of the crucible are melted; it is then kept at this temperature for fifteen minutes. After cooling, the melt is extracted with water, filtered, the residue boiled with pure dilute sodium carbonate solution and finally washed with water to the disappearance of the alkaline reaction. The filtrate is treated in a covered beaker with an excess of hydrochloric acid boiled to expel the carbon dioxide, and evaporated to dryness. In order to remove all of the nitric acid, the dry mass is treated with 10 c.c. concentrated hydrochloric acid and again evaporated to dryness. This last residue is moistened with 1 c.c. concentrated hydrochloric acid, treated with 100 c.c. water, and filtered if necessary. The filtrate is diluted to 450 c.c., heated to boiling and precipitated with 24 c.c. of normal barium chloride solution† which is diluted to 100 c.c. and added as quickly as possible while stirring vigorously (cf. sulphuric acid).

Remark.—This is the most reliable method for determining the total amount of sulphur in insoluble sulphides and serves for testing values obtained by other methods.

It is important, however, to conduct the fusion in such a manner that none of the combustion products of the sulphur in the illuminating-gas comes in contact with the contents of the crucible. This is accomplished, as suggested by Löwe,‡ by placing the crucible in an inclined position within a hole in a piece of asbestos board.

2. Method of Böckmann.

In order to avoid the tedious operation of destroying the nitrate which is necessary in the method of Fresenius, Böckmann fuses 0.5 gm. of the substance with 25 gms. of a mixture of six parts sodium carbonate and one part potassium chlorate. The contents of the crucible are heated gently at first and finally until there is no more

* Glaser recommends sodium peroxide as an oxidizing flux, in which case a nickel or iron crucible must be used. See Chem. Ztg., 18, 1448, and Z. anal. Chem., 34, 594 (1895) and List, Z. angew. Chem., 1903, 414. Glaser's method is given in Appendix I.

† 122 gm. of the solid $\text{BaCl}_2 \cdot 2\text{H}_2\text{O}$ dissolved in a liter of water.

‡ Z. anal. Chem., 20, 224 (1881).

evolution of oxygen. After cooling the melt is extracted with water, the filtrate acidified with hydrochloric acid and precipitated at a boiling temperature with barium chloride.

This method is held to be less accurate than that of Fresenius, but according to the author's experience it is equally good.

3. Oxidation by Chlorine (Rose).

This very important method is used less to determine the amount of sulphur present in insoluble sulphides than it is to effect the solution of the sulphide for the separation and determination of the metals. As an example of this sort of an analysis we will consider the

Analysis of Tetrahedrite (Fahlerz).

Tetrahedrite is a sulpho-salt corresponding to the general formula $4MS \cdot R_2S_3$ in which M is Cu_2 , Ag_2 , Fe, Zn, or Hg_2 , and R is As, Sb, or Bi.

From 0.5–1 gm. of the finely-powdered mineral is introduced by means of a long weighing-tube into the bulb of the tube *R*, Fig. 56, which is 30 cm. long and $1\frac{1}{2}$ cm. wide and made of difficultly fusible glass.

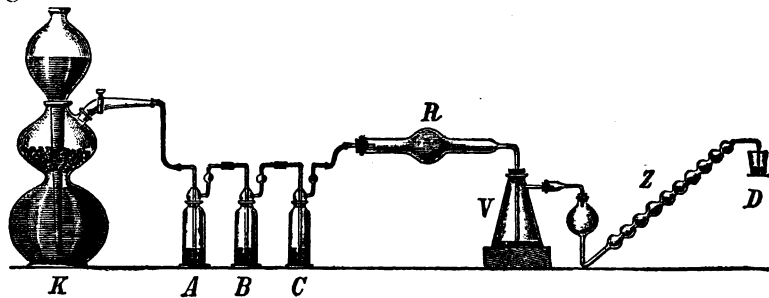

FIG. 56.

In the receivers *V* and *Z* are placed about 100 c.c. of hydrochloric acid (1:4) to which 3.5 gms. of tartaric acid have been added, and a slow but steady stream of chlorine* is conducted through the apparatus.

* The chlorine is generated in a Kipp apparatus from chloride of lime and hydrochloric acid. In order to purify the gas it is passed through the wash-bottles *A*, *B*, and *C*. The first contains water and the other two contain con-

As soon as the chlorine reaches the substance in *R*, the decomposition begins. The contents of *R* become heated and the volatile chlorides collect in the front part of the tube. When the action begins to diminish, the decomposition is assisted by heating *R* with a small flame kept in constant motion. The heating is continued until only brown vapors of ferric chloride are given off; as little as possible of these should pass into the receiver. The easily volatile chlorides, however, are driven over into *V* as much as possible by carefully heating with the flame. After allowing to cool in an atmosphere of chlorine, the tube *R* is broken by first scratching with a file near the drawn-out part and then touching it with a hot glass rod. Over each of the open ends of the tube a clean, moist test-tube is placed and allowed to stand this way overnight; in this way the sublimate absorbs water and can be easily washed off in the morning. The contents of *V* and *Z* are poured into a beaker and the drawn-out part of *R* is washed out with hydrochloric acid containing tartaric acid.

The Residue A

consists of silver, lead, and copper chlorides, almost all of the zinc, lead, considerable amounts of iron, and the gangue.

The Solution B

contains all of the sulphur as sulphuric acid, the bismuth as chloride, the arsenic and antimony as their pentoxide compounds, a part of the iron and zinc and often small amounts of lead.

Treatment of the Residue A.

This is warmed for a long time with dilute hydrochloric acid, diluted with water, allowed to settle, and the residue consisting of silver chloride and the gangue is filtered off, washed thoroughly with hot water in order to make sure that all lead chloride is removed, treated with ammonia on the filter and the silver precipitated from the ammoniacal filtrate by acidifying with hydrochloric acid, and determined as the chloride. The residue, insoluble in ammonia, is ignited wet in a platinum crucible and weighed.

centrated sulphuric acid. It is also well to introduce a calcium chloride tube filled with pieces of calcite between *C* and *R* in order to remove traces of acid.

Into the filtrate from the silver chloride, hydrogen sulphide is passed until the solution is saturated with the gas, the precipitate consisting of copper and lead sulphides is filtered off, and the lead separated from the copper as sulphate according to p. 200. The filtrate from the hydrogen sulphide precipitate is combined with that obtained from Solution B after hydrogen sulphide has been passed into it.

Treatment of Solution B.

A stream of carbon dioxide is passed through the solution for some time in order to remove the greater part of the excess of chlorine, and hydrogen sulphide is then passed into it at the temperature of the water-bath. The precipitate, consisting of sulphides of arsenic, antimony, mercury, and possibly bismuth, is filtered off after standing twelve hours, and the arsenic and antimony separated from the mercury and bismuth by means of ammonium sulphide as described on p. 235. From the ammonium sulphide solution the arsenic and antimony are precipitated by acidifying with dilute hydrochloric or sulphuric acid, the precipitated sulphides filtered off and the arsenic separated from the antimony as described on p. 241 *et seq.*

The precipitate insoluble in ammonium sulphide usually consists almost entirely of mercuric sulphide and sulphur, in which case it is washed first with alcohol, then a few times with carbon bisulphide, then with alcohol again, dried at 100° C. (preferably in a Paul's drying-oven) and weighed. If bismuth is present, however, the mixture of the two sulphides is treated with nitric acid of sp. gr. 1.2–1.3, boiled, an equal volume of water added, the residue filtered and the bismuth determined in the filtrate according to p. 194, while the mercury is determined as above described.

The filtrate from the hydrogen sulphide precipitate contains iron and zinc and is combined with the corresponding filtrate from the Residue A, which likewise contains these metals. These are precipitated by the addition of ammonia and ammonium sulphide, filtered off, dissolved in hydrochloric acid, the solution oxidized with nitric acid, and the iron separated from the zinc, preferably by the barium carbonate method (see p. 150).

• It is best to determine the sulphur in a separate portion by fusion with sodium carbonate and potassium nitrate as described on p. 358.

The determination of the sulphur in an aliquot part of the Solution B is not to be recommended on account of the fact that the metals present are likely to contaminate the precipitate of barium sulphate.

(B) OXIDATION OF SULPHUR IN THE WET WAY.

For this purpose aqua regia, fuming nitric acid, bromine, hydrochloric acid and potassium chlorate, and, in some cases, ammoniacal hydrogen peroxide have been proposed.

Aqua regia is most frequently used in practice and in the proportion first recommended by J. Lefort,* viz., 3 volumes of nitric acid of sp. gr. 1.4 and 1 volume of hydrochloric acid of sp. gr. 1.2. As an example we will cite the

Determination of Sulphur in Pyrite, G. Lunge's Method.†

The sample should be finely ground, but it must be borne in mind that rapid grinding in the air may generate enough heat to cause the oxidation of some sulphur so that an appreciable amount escapes as dioxide. Of the fine powder, 0.5 gm. is treated with 10 c.c. of a mixture consisting of 3 parts nitric acid, sp. gr. 1.42, and 1 part hydrochloric acid, sp. gr. 1.2, in a 300 c.c. beaker which is covered with a watch-glass. At first the acid is allowed to act upon the pyrite in the cold, but at the last the reaction is completed by heating upon the water-bath. Then the solution is transferred to a porcelain evaporating dish and evaporated to dryness on the water-bath. The residue is treated with 5 c.c. of concentrated hydrochloric acid and again evaporated to dryness. The dry mass is now treated with 1 c.c. of concentrated hydrochloric acid and 100 c.c. of hot water, the solution filtered through a small filter and the residue washed first with cold water and then with hot water. The hot filtrate, of not more than 150 c.c. at

* J. de Pharm. et. de Chimie [IV], Vol. 9, p. 99, and Zeit. für anal. Chem., IX, p. 81.

† The procedure is given here as recommended by the Report of the Sixth International Congress of Applied Chemists, Rome, 1906, Vol. VI, p. 15.

the most, is treated with 20 c.c. of 10 per cent. ammonia and kept at about 70° for fifteen minutes. The ferric hydroxide precipitate is filtered and washed with hot water, whereby the precipitate is well "churned," until a volume of about 450 c.c. is reached. The filtrate is neutralized with hydrochloric acid, using methyl orange as indicator, and 1 c.c. of concentrated hydrochloric acid added in excess. Thereupon the solution is heated until it begins to boil, when 100 c.c. of boiling-hot, fifth-normal barium chloride solution is added while stirring vigorously.*

The barium sulphate precipitate is washed three times by decantation with boiling water, then transferred to a filter and washed free from chlorides, dried, ignited and weighed.

To test the ammonia precipitate for sulphur, transfer it from the filter into a beaker by means of a stream of water from the wash bottle and dissolve it by the addition of as little hydrochloric acid as possible. The resulting solution is precipitated with ammonia, filtered, and the filtrate and washings treated as in the case of the main analysis. Should any barium sulphate be obtained in this way, it should be filtered off and weighed with the main part of the barium sulphate precipitate.

Remark.—It is still better to filter the precipitate through a Munroe crucible. After washing, the precipitate is dried as much as possible by suction, the crucible placed within a larger porcelain or platinum crucible, heated gently and weighed.

The above method gives excellent results, which as a rule agree closely with those obtained by the Fresenius method. If the pyrite, however, contained barium or any considerable amount of lead, some sulphate will always remain undissolved with the gangue. In such cases the Lunge method will give lower results but on the other hand it represents more nearly the quantity of sulphur in the pyrite which is available for the manufacture of sulphuric acid. In spite of the strong oxidizing power of the above mixture of nitric and hydrochloric acids, it is not sufficient to permit the determination of sulphur in roasted pyrite, on account of the danger of losing some sulphur as hydrogen sulphide. Such

* The concentration of the precipitant when added to the solution at this stage of the analysis should not be greater than fifth normal, or the results will be too high.

products are fused with a mixture of two parts sodium carbonate and one part potassium nitrate and the analysis carried out as described under the Fresenius method.

*Determination of Sulphur in Cast Iron and Steel. (Noyes and Helmer *).*

About 5 gms. of iron or steel, in the form of fine borings, are introduced gradually into an Erlenmeyer flask containing a cooled mixture of 200 c.c. water and 8 c.c. bromine, free from sulphur. As soon as all the metal has dissolved, the contents of the flask are heated to boiling, in order to expel the slight excess of bromine, and the solution is filtered from any residue. Inasmuch as the latter frequently contains an appreciable amount of sulphur, it is dried, transferred to a platinum crucible, the ash of the filter paper added, and a fusion is made with 2 gms. sodium carbonate. The crucible should be inclined within an asbestos shield to protect its contents from being contaminated with any sulphur from the gas flame. After the sodium carbonate has melted, the crucible is allowed to cool somewhat, a crystal of potassium nitrate is added, and the heating is continued. After cooling, the melt is dissolved in water, the resulting solution filtered, the filtrate acidified with hydrochloric acid, heated to boiling, and the sulphuric acid precipitated by the addition of 5 c.c. barium chloride solution. In the following calculation, the weight of this precipitate is called *p*.

The original solution of the iron, containing the greater part of the sulphur, is poured, while constantly stirring, into 130 c.c. of 10 per cent. ammonia water which is contained in a 500-c.c. calibrated flask. The contents of the flask are well shaken, diluted with water up to the mark, mixed by pouring back and forth several times into a dry beaker, and then filtered through a dry filter, rejecting the first few c.c. of the filtrate. From the strongly ammoniacal filtrate, 300 c.c. are transferred by a pipette into a new beaker, evaporated to 100 c.c., while avoiding any contamination from a gas flame, treated with five or six drops of dilute

* J. Am. Chem. Soc., 23, 675 (1901).

hydrochloric acid and the sulphuric acid precipitated by the addition of 5 c.c. of hot, normal barium chloride solution. The weight of this precipitate is taken as p_1 in the following computation.

The sulphur content of the sample of iron or steel, weighing a gms., is then found to be

$$\frac{(\frac{5}{3}p_1 + p) \times S \times 100}{\text{BaSO}_4 \times a} = 13.73 \times \frac{\frac{5}{3}p_1 + p}{a} = \text{per cent. sulphur.}$$

Remark.—This method is accurate and easily carried out. All the sulphur is obtained with the exception of that small amount which is combined with an organic radical. A great advantage is gained by not having to wash the ferric hydroxide precipitate. A very slight error is introduced by neglecting the volume of the ferric hydroxide precipitate, but this is negligible in the determination of such small amounts of sulphur. The iron must be introduced into the bromine in very small portions in order to prevent overheating which would result in the formation of a basic salt that is hard to get back into solution.

*Determination of Sulphur in Iron and Steel. Method of Krug.**

Procedure.—5 gms. of borings are treated in a 500-c.c. round-bottomed flask with 50 c.c. concentrated nitric acid, sp. gr. 1.4 and the contents of the flask are gently heated. After the reddish-brown vapors cease to form, the acid is gradually heated up to the boiling point. When at the end of an hour or two the solution of the iron is complete, 0.25 gm. of potassium nitrate, dissolved in a little water, is added, the liquid evaporated to dryness, and the residue ignited until no more brown fumes are evolved. After cooling, the ferric oxide is dissolved by heating with 50 c.c. concentrated hydrochloric acid, the solution evaporated nearly to dryness, and the treatment with hydrochloric acid and evaporation repeated until no more chlorine is evolved. The hydro-

* Stahl und Eisen, 25, 887 (1905).

chloric acid solution is then rinsed into a beaker, and any residue of silica, carbon, etc., is filtered off into a porcelain evaporating dish. The filtrate is evaporated until a film of ferric chloride forms on the solution, which is redissolved by the addition of a few drops of hydrochloric acid. After cooling the ferric chloride solution is introduced into a double separatory funnel, washing out the dish with hydrochloric acid, sp. gr. 1.1, but keeping the volume below 60 c.c. 30 c.c. of fuming hydrochloric acid and ether mixture (prepared by gradually pouring ether into cold concentrated hydrochloric acid, sp. gr. 1.2, solution until a little layer of ether is formed on top) and 100 c.c. of ether. The mixture is well cooled under the water tap and thoroughly shaken. The upper olive-green ether layer contains nearly all of the iron, the lower light yellow solution contains all the sulphuric acid. The lower layer is carefully withdrawn into the other separatory funnel and the ether solution is washed once with a few c.c. of dilute hydrochloric acid, sp. gr. 1.1 which has been saturated with ether. The ether solution is shaken with this last mixture and after standing until two layers again separate, the lower one is added to the contents of the other separatory funnel. 75 c.c. of pure ether are now introduced into the second separatory funnel and the contents well shaken, this time the cooling is unnecessary. The upper layer will contain an ether solution of practically all the remaining iron, whereas the lower hydrochloric acid layer will contain all the sulphuric acid and some dissolved ether. The lower layer is withdrawn to a porcelain evaporating dish, and the ether contained in it is removed by evaporating on the water bath to dryness. To the residue, a few drops of hydrochloric acid and a little water are added. The solution is filtered and the hot filtrate treated with hot barium chloride solution.

Remark.—In testing this method, Dr. Krug established the fact that a mixture of pure ferric chloride, corresponding to 5 gms. iron, could be treated with 10 c.c. of tenth-normal sulphuric acid, and all of the latter recovered after the ether separation. The results were found to be more reliable than those obtained by an evolution method.

(c) EXPULSION OF HYDROGEN SULPHIDE FROM INSOLUBLE
SULPHIDES.(a) *The Iron Method*.*

In 1881, M. Gröger showed that by heating pyrite with iron out of contact with the air the former is quantitatively changed into ferrous sulphide,

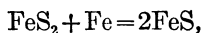

and from the latter all of the sulphur will be given off as hydrogen sulphide on treatment with hydrochloric acid. In 1891 the author independently came to the same conclusion and worked out a method which permits of the determination of sulphur not only in pyrite but in all other insoluble sulphides.

Procedure.—First of all the finely powdered sulphide is heated out of contact with the air with iron powder. In this way part of the sulphur is usually given up to the iron, and the compound itself is reduced to compounds which are acted upon by hydrochloric acid with evolution of hydrogen sulphide; the latter is absorbed in ammoniacal hydrogen peroxide solution, as described on p. 347. The heating with iron is accomplished in a small glass crucible about 30 mm. long and 10 mm. in diameter (Fig. 54, *b*), which can be easily made from an ordinary piece of combustion tubing. About 3 gms. of iron powder that has been previously ignited in hydrogen is placed in the crucible, from 0.3–0.5 gm. of the sulphide is thoroughly mixed with it, and the mixture is finally covered with a thin layer of iron powder. The crucible is now placed in the opening of the piece of asbestos board *A* (Fig. 54, *b*) and upon it is placed the gas-delivery tube *B* which has been prepared from difficultly fusible glass. A stream of dry carbon dioxide † is passed through the apparatus for a few min-

* Berichte, XXIV, p. 1937.

† The carbon dioxide is prepared from marble and hydrochloric acid in a Kipp generator. To purify the gas it is passed through a wash-bottle containing water, then through one containing potassium permanganate, then through a tube filled with pumice soaked in copper sulphate solution, and finally through a calcium chloride tube. Potassium permanganate and copper sulphate serve to remove traces of hydrogen sulphide that the carbon dioxide might contain.

utes and the crucible is gently heated with a small flame. Usually there is a distinct glowing visible, but no trace of the sulphur is lost by volatilization. As soon as the contents of the crucible have ceased to glow, the temperature is raised until a dull-red heat is obtained, and the crucible is kept at this temperature for ten minutes.

After cooling in the carbon dioxide, the crucible together with its contents is placed in the 400-c.c. flask *K* and is connected with the absorption vessels *V* and *P* as shown in the figure. The rest of the procedure is carried out as described on p. 350.

Remark.—Commercial iron powder always contains a small amount of sulphur, so that a blank experiment is first made with a weighed amount of the same, and for the experiment proper the same amount of iron is used. The amount of sulphur found to be present in the iron is subtracted from the amount found in the analysis.

The author was disappointed in not being able by this method to distinguish between the sulphur present in insoluble sulphides as sulphide and that present as sulphate (barium sulphate). If the amount of sulphate present is small, it is completely reduced to sulphide by this method, while if a large amount of sulphate is present, it is often only partially reduced. As, however, the amount of barium sulphate* present in insoluble sulphides is usually small, this method serves for the determination of the total amount of sulphur.

(b) *The Tin Method.*†

Principle.—Almost all insoluble sulphides on being treated with metallic tin and concentrated hydrochloric acid give off all their sulphur as hydrogen sulphide. Harding,‡ who first studied this method, used tin and hydrobromic acid.

Procedure.—Into the evolution tube (Fig. 57), which is 20 cm. long and 2.5 cm. wide, is placed a layer of finely-powdered tin (*g*) about 0.5 cm. thick. Upon this the substance is placed enclosed in tinfoil (*s*) and then a layer of granulated tin about 6 cm. deep

* Only barium sulphate is reduced with difficulty, the sulphates of the heavy metals are easily reduced.

† Berichte, XXV, p. 2377.

‡ Berichte, XIV, p. 2085.

(Z) is added. A current of pure hydrogen is conducted through the apparatus for about five minutes, after which the stop-cock

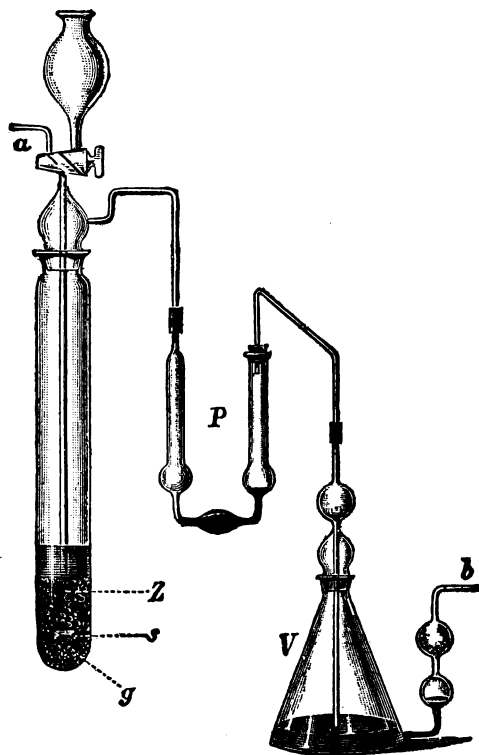

FIG. 57.

is closed and the tube connected with the receivers *P* and *V*, as shown in the figure. The flask *V* contains an ammoniacal solution of hydrogen peroxide, while *P* contains 2 to 3 cm. of water in order to remove any stannous chloride that may be carried over with the gas. Concentrated hydrochloric acid is now added through the drop-funnel until the tin is at the most half covered with the acid. The contents of the tube are then warmed slightly, preferably by placing it in a small paraffin bath. The capsule of tin soon dissolves, and the substance is seen to be floating in the acid. It dissolves after about fifteen minutes, and the acid becomes

perfectly clear. The heating is now continued until there is no more yellow coloration to be detected in the delivery-tube which dips into the receiver *V*. More acid is then added to the contents of the tube, until the tin is completely covered with it and the heating is continued for half an hour, meanwhile first heating the contents of *P* to boiling and passing a current of hydrogen through *a*. By this means all of the sulphur will be driven over into *V** and is there held in solution as ammonium sulphate and analyzed as described on p. 350.

Remark.—This method affords an accurate means for determining the sulphur present in insoluble sulphides as sulphide in the presence of sulphate. Thus the amount of pyrite in clay-slate that contains gypsum can be determined by this method, although usually the treatment with aqua regia or fusion with soda and nitre is used. By these last two methods, however, the *total* sulphur is determined. More accurate values for the *pyrite* present in such cases may be obtained by decomposition in a current of chlorine (see p. 359), in which case only the sulphide sulphur is determined.

Finally, it may be mentioned that arsenic sulphide may be decomposed by the above method, although a longer time is required than is the case with pyrite, copper, chalcopyrite, galena, cinnabar, etc. Arsenopyrite, on the other hand, is either unacted upon or only decomposed with difficulty, while the iron method effects the decomposition with ease.

Determination of Sulphur in Non-electrolytes.

In order to determine the amount of sulphur present in organic compounds, it is oxidized to sulphuric acid and determined as barium sulphate.

The oxidation is effected

(a) *In the Wet Way.*

(b) *In the Dry Way.*

(a) *Oxidation in the Wet Way (Carius).*

This operation is conducted in precisely the same manner as was described on p. 325 for the determination of halogens, except

* With large amounts of sulphur, one receiver is often insufficient. In such cases the tube *b* is connected with a Pélignot tube containing ammoniacal hydrogen peroxide as shown in Fig. 54, p. 351.

in this case there is no silver nitrate added to the contents of the tube. After the closed tube has been heated and opened, its contents are transferred to a beaker, hydrochloric acid is added, and the liquid is evaporated to a small volume in order to remove the nitric acid; it is then diluted with water to a volume of about 200 c.c. and precipitated hot with a boiling solution of barium chloride and weighed as barium sulphate.

(b) *Oxidation in the Dry Way (Liebig).*

A mixture of eight parts potassium hydroxide (free from sulphate) and one part of potassium nitrate is melted in a large silver crucible with the addition of a little water. After cooling, a weighed amount of the substance is added and the contents of the crucible again heated very gradually, frequently stirring the mixture with a silver wire until the organic substance is completely decomposed. After cooling, the melt is dissolved in water, acidified with hydrochloric acid and the sulphuric acid formed is precipitated and weighed as barium sulphate.

This method is particularly suited for the determination of sulphur present in difficultly volatile substances, e.g., in wood-cements.

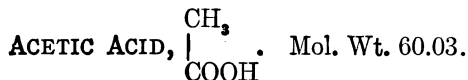

Free acetic acid is always determined volumetrically. For the analysis of acetates, the substance is heated with phosphoric acid when the free acetic acid distils over and is then titrated (cf. Part II, Acidimetry). The carbon and hydrogen of the acetate can be determined by Elementary Analysis (which see).



The only method for examining cyanates consists of determining the amount of carbon and nitrogen present by a combustion (see Elementary Analysis).

Determination of Cyanic Acid, Hydrocyanic Acid, and Carbonic Acid in a Mixture of their Potassium Salts.

In one portion of the substance the carbonic acid is determined by the addition of calcium chloride to the ammoniacal solution and weighing the ignited precipitate as calcium oxide.

In a second portion the cyanogen of the cyanide is determined as silver cyanide by treating the aqueous solution with an excess of silver nitrate, then acidifying with nitric acid and determining the weight of the silver cyanide as described on p. 328.

In a third portion the potassium is determined by evaporating with sulphuric acid and weighing the residue of potassium sulphate as described on p. 41. If from the total amount of potassium present the amount present as potassium carbonate and potassium cyanide is deducted, the difference gives the amount of potassium combined with the cyanic acid.

HYPOPHOSPHOROUS ACID, H_3PO_2 . Mol. Wt. 66.06.

Forms: **Mercurous Chloride, Hg_2Cl_2 ; Magnesium Pyrophosphate, $\text{Mg}_2\text{P}_2\text{O}_7$.**

(a) Determination as Mercurous Chloride.

The solution of the salt, which is slightly acid with hydrochloric acid, is treated with an excess of mercuric chloride; by this means insoluble mercurous chloride is precipitated. After standing for twenty-four hours in a warm, dark place the precipitate is filtered through a Gooch crucible, washed with water dried at 110°C ., and from the weight of the mercurous chloride the amount of hypophosphorous acid present is calculated as follows:

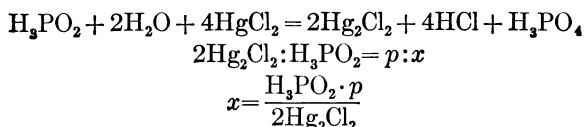

in which p is the weight of the Hg_2Cl_2 obtained in the analysis.

(b) Determination as Magnesium Pyrophosphate.

First of all, the phosphorous acid is converted into phosphoric acid by adding 5 c.c. of concentrated nitric acid to the aqueous solution of from 0.5–1 gm. of the substance in about 100 c.c. of water,* evaporating on the water-bath to a small volume, adding a few drops of fuming nitric acid and again heating. After this the phosphoric acid is precipitated by magnesia mixture and the pre-

* If the hypophosphite were at once treated with nitric acid, metaphosphoric acid would be obtained; by the addition of water the ortho-salt is formed.

cipitate is weighed as magnesium pyrophosphate as described under Phosphoric Acid.

GROUP III.

SULPHUROUS, SELENOUS, TELLUROUS, PHOSPHOROUS, CARBONIC, OXALIC, IODIC, BORIC, MOLYBDIC, TARTARIC, META- AND PYROPHOSPHORIC ACIDS.

SULPHUROUS ACID, H_2SO_3 . Mol. Wt. 82.09.

Form: Barium Sulphate, $BaSO_4$.

The sulphite or free sulphurous acid is first oxidized to sulphuric acid and then precipitated with barium chloride.

The oxidation can be accomplished by means of chlorine, bromine, hydrogen peroxide, or potassium percarbonate.

Oxidation with Chlorine or Bromine.

Chlorine or bromine water is allowed to flow gradually into the aqueous solution of sulphurous acid, or of a sulphite, the excess of the reagent is subsequently removed by boiling and the sulphuric acid is precipitated with barium chloride.

*Oxidation with Hydrogen Peroxide.**

The solution of sulphurous acid or of a sulphite is treated with an excess of ammoniacal hydrogen peroxide, heated to boiling in order to remove the excess of the peroxide, acidified with hydrochloric acid and precipitated with barium chloride after making acid with hydrochloric acid.

With potassium percarbonate a similar procedure is used. The alkaline solution of the sulphite is treated in the cold with solid potassium percarbonate, gently heated, after which the temperature is gradually raised till the boiling-point is reached. The solution is then acidified with hydrochloric acid and precipitated with barium chloride.

* The hydrogen peroxide must always be tested to see if it contains sulphuric acid; if it is found to be present, the amount is determined and afterward an accurately measured quantity is used for the oxidation. The amount of sulphuric acid from the peroxide is deducted from the total value found in the analysis.

Sulphurous acid may be determined very accurately by a volumetric analysis (cf. Part II, Iodimetry).

Selenous and Tellurous Acids.

The analysis of these acids was discussed under Selenium and Tellurium.

PHOSPHOROUS ACID, H_3PO_3 . Mol. Wt. 82.06.

Forms: Mercurous Chloride, Hg_2Cl_2 , and Magnesium Pyrophosphate, $Mg_2P_2O_7$.

This determination is effected exactly as that of hypophosphorous acid (cf. page 372).

In this case, however, it is to be noted that 1 mol. Hg_2Cl_2 corresponds to 1 mol. H_3PO_3 :

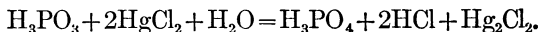

Determination of Phosphorous and Hypophosphorous Acids.

In this case an indirect analysis must be made. After oxidizing one portion of the substance to phosphoric acid, the total amount of magnesium pyrophosphate is found; mercuric chloride is allowed to act upon a second portion and the weight of the mercurous chloride formed is determined. From these data the amount of each acid present can be calculated as follows:

Suppose we have a solution containing the two acids. Let us denote by x the amount of hypophosphorous acid present in V c.c. of the solution, and let ox represent the amount of mercurous chloride produced from it and mx the amount of magnesium pyrophosphate. Further, let y represent the amount of phosphorous acid present in the same volume of the solution and vy the corresponding amount of mercurous chloride and ny that of magnesium pyrophosphate. The total amount of the mercurous chloride is q , while the total amount of magnesium pyrophosphate is p . We have then

$$mx + ny = p$$

$$ox + vy = q$$

from which it follows

$$x = q \frac{n}{on - mv} - p \frac{v}{on - mv} = q \cdot 0.1402 - p \cdot 0.5925$$

and

$$y = p \frac{o}{on - mv} - q \frac{m}{on - mv} = p \cdot 1.4733 - q \cdot 0.1742.$$

In these equations, m , n , o , and v have the following values:

$$m = \frac{\text{Mg}_2\text{P}_2\text{O}_7}{2\text{H}_3\text{PO}_2} = 1.687 \quad n = \frac{\text{Mg}_2\text{P}_2\text{O}_7}{2\text{H}_3\text{PO}_3} = 1.358$$

$$o = \frac{2\text{Hg}_2\text{Cl}_2}{\text{H}_3\text{PO}_2} = 14.26 \quad v = \frac{\text{Hg}_2\text{Cl}_2}{\text{H}_3\text{PO}_3} = 5.741$$

CARBONIC ACID, H_2CO_3 . Mol. Wt. 62.02.

Carbonic acid is determined gravimetrically as CO_2 ; but a more accurate determination is effected by expelling this gas and measuring its volume.

I. Gravimetric Determination of Carbon Dioxide.

This analysis may be accomplished in two ways. First, we may weigh the substance, expel the carbon dioxide and then weigh it again, when the difference will represent the amount of gas. Second, the carbon dioxide may be expelled from a weighed amount of the substance and then absorbed in a suitable apparatus; in this case the carbon dioxide is weighed directly.

A. DETERMINATION OF CARBONIC ACID BY DIFFERENCE.

(a) *Determination in the Dry Way.*

For the analysis of a carbonate, or a mixture of carbonates which contains no volatile constituent other than the carbon dioxide, 1 gm. of the substance is weighed into a platinum crucible and gradually heated to a high temperature.* In case calcium, strontium, or magnesium is present a final heating over the blast-lamp is necessary, while with other carbonates the heat of a good Teclu burner is sufficient; even the difficultly decomposable cadmium carbonate can be analyzed by this method. The carbonates of barium and the alkalies, on the other hand, do not lose their carbon dioxide on ignition.

* Carbonic acid cannot be determined by this method when the residual oxide suffers change, as, for example, in the case of FeCO_3 and MnCO_3 , where an oxidation would take place.

If the substance contains water besides carbon dioxide then the sum of the water + carbon dioxide is determined by the loss on ignition, and the amount of carbon dioxide is determined in a second portion by (b).

(b) *Determination in the Wet Way.*

Principle.—The weighed carbonate is placed in an apparatus containing acid, but in such a way that the former does not at first come in contact with the latter. The whole apparatus is then weighed, after which the acid is allowed to act upon the substance, when carbon dioxide is evolved and escapes from the apparatus. (Care must be taken that no moisture escapes with the gas.) By afterward weighing the apparatus and subtracting this weight from that first obtained, the weight of the carbon dioxide is ascertained.

Procedure.—This analysis is easily accomplished, and a large number of different forms of apparatus have been devised for this purpose. In this book, however, only one of these so-called alkalimeters will be described, namely, that of Mohr, which in an improved form is shown in Fig. 58, although it must be stated that many other forms (e.g., those of Bunsen,* Shrötter, Geissler, Fresenius-Will, etc.) answer the purpose equally well.

The alkalimeter consists of the small, wide-mouthed, flat-bottomed flask *F*, which has a ground-glass connection with the tubes

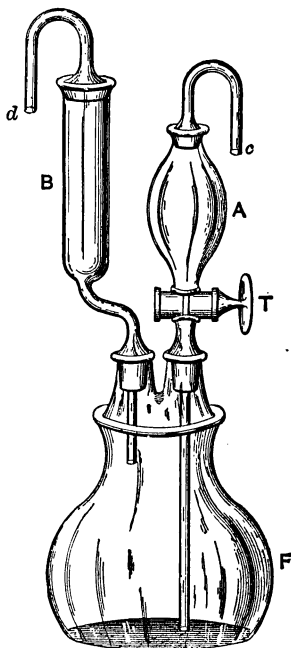

FIG. 58.

* In the German edition of this book, Bunsen's alkalimeter is described instead of Mohr's. The above apparatus has the advantage of having a stopcock to separate the acid compartment from the flask, besides having a flat bottom, upon which it will rest unsupported. It is all made of very thin glass and weighs comparatively little.

A and *B*. At the bottom of *B* is placed a loose wad of cotton; a cylinder of glazed paper about 3 cm. wide is introduced into the neck of the tube, and through this cylinder some pieces of sifted calcium chloride* are poured. The paper cylinder is removed after the tube is about three-quarters full of calcium chloride, and care is taken to see that none of the latter adheres to the glass above the filled portion. Another wad of cotton is then placed in the tube, the top is placed upon it, and the tube is closed temporarily at *d* by means of a piece of stirring-rod within rubber tubing. The tube should be kept closed when not in use to prevent the gradual absorption of moisture from the air. Two ordinary calcium chloride tubes are filled in the same way about two-thirds full, but in this case softened cork stoppers are placed at the end of the tubes after the second wad of cotton. Through a hole in each stopper a short piece of glass tubing with rounded ends is introduced, and the cork is shoved far into the tube with the help of a stirring-rod, leaving the outer 2 or 3 mm. empty. This space in the tube is filled with molten sealing-wax, so that a perfectly air-tight connection is made. These tubes are also closed, when not in use, by stirring-rod within rubber tubing.

Before beginning the determination the apparatus must be clean and dry. It is not advisable to dry the flask by washing with alcohol and ether, but it should be gently heated while a current of dry air is sucked through it. As aspirator an inverted wash-bottle may be used, from which the water is allowed to run out slowly through the shorter tube. During the aspiration the small calcium chloride tubes are connected with *c* and *d* respectively, so that no moisture can enter the flask.

When all is ready the finely-powdered substance, which has been dried at 100° C. and cooled in a desiccator, is placed in a weighing-tube, from 1 to 1.5 grs. are transferred to the flask and a little water is added.† The tube *A* is now filled two-thirds full

* As commercial calcium chloride always contains a little free lime, some carbon dioxide will be absorbed by it and consequently low results obtained in the analysis, unless the calcium chloride is saturated with carbon dioxide before the analysis is made (see foot-note, page 380).

† This method is often used for the determination of the carbonic acid in baking-powders. Such substances are decomposed by water so that they should be kept dry until after the apparatus has been weighed.

with hydrochloric acid (1 part concentrated acid to 4 of water) by means of a small funnel or thistle tube, and the stop-cock *T* must be turned so that none of the acid will run into the flask. The whole apparatus, as shown in Fig. 58, is now placed upon the balance-pan and accurately weighed. The stop-cock *T* is then opened so that the acid in *A* slowly drops into the flask. As soon as the evolution of carbon dioxide begins to take place quietly, the apparatus is allowed to stand without watching for about half an hour. At the end of this time all of the acid will have passed into the flask, and the decomposition will be nearly complete in most cases. It now remains to remove all carbon dioxide absorbed by the liquid and contained in the apparatus. This is effected by gently heating the solution by means of a small flame until the acid just begins to boil, meanwhile aspirating a current of dry air through *c* and out at *d*. Not more than three or four bubbles of air per second should be allowed to pass through the flask. As soon as the boiling begins, the flame is removed and the slow current of air is still passed through the apparatus until it is cold. It is then stoppered and allowed to stand near the balance for half an hour or more, after which it is again weighed without the stoppers. The loss in weight represents the amount of carbon dioxide originally present in the substance as carbonate.

Remark.—This method affords excellent results in the estimation of large amounts of carbonic acid, but it is unreliable for the analysis of small amounts such as are present in cements, etc. In such cases the Fresenius-Classen or Lunge-Marchlewski method is better. (See pp. 380 and 388.)

The objection to this method lies in the fact that owing to the size and weight of the apparatus, there is likely to be an error in making the two weighings.* On the other hand, it is unquestionably true that it is easier to expel carbon dioxide from a solution than it is to absorb it quantitatively.

B. DIRECT DETERMINATION OF CARBON DIOXIDE.

Here again the determination can be carried out both in the dry and wet ways.

* There is some danger of losing a little hydrochloric-acid gas during the operation. To prevent this the calcium chloride may be replaced by pumice impregnated with anhydrous copper sulphate, or the carbonate may be decomposed by means of sulphuric acid.

(a) *Determination in the Dry Way.*

From one to two grams of the substance are weighed out into a porcelain boat, and the latter is shoved into the middle of a horizontally held glass tube which is about 20 cm. long and 1–1.5 cm. wide, and made of difficultly fusible glass. Both ends of the tube are provided with calcium chloride tubes connected with it by means of tightly-fitting rubber stoppers. Through one of the calcium chloride tubes a slow stream of air (free from carbon dioxide)* is conducted and the other is connected with two weighed soda-lime tubes (cf. p. 380). The substance is heated gradually until it glows strongly, meanwhile passing a slow but steady current of air through the apparatus. When there is no further heat effect to be detected in the soda-lime tubes, the substance is allowed to cool in the current of air and the soda-lime tubes are subsequently weighed. The increase of weight represents the amount of carbon dioxide.

Remark.—This method can be employed for the analysis of all carbonates with the exception of those of barium and the alkalies,† though, of course, no other volatile acid can be present at the same time. Water is kept back by the calcium chloride tube.

Example: Analysis of White Lead.—White lead, provided it is free from acetate (which must be shown by a qualitative test), can be accurately and expeditiously analyzed by the above method. It is a basic carbonate of lead and contains, therefore, lead oxide, carbon dioxide, and water, while it is often contaminated with sand.

The analysis is conducted as above described except that in this case the calcium chloride tube which is connected with the soda-lime tubes is weighed. The gain in weight of the former represents the amount of water in the substance, the gain in weight of the latter shows the amount of carbonic acid present, while if the

*The air is passed through two wash-bottles containing caustic potash solution.

† Even the carbonates of the alkalies and of barium can be analyzed in this way if they are mixed with potassium bichromate.

residue in the porcelain boat is weighed the amount of lead oxide is determined. After weighing the latter the lead oxide is treated with hot, dilute nitric acid, when it will dissolve to a clear solution if pure, while any sand will remain behind as an insoluble residue. If there is a residue it is filtered off, ignited, and weighed. By deducting the latter from the original weight of the residue in the porcelain boat, the weight of the pure lead oxide is obtained.

(b) *Determination in the Wet Way, after Fresenius-Classen.*

The apparatus necessary for this determination is shown in Fig. 59. It consists of a decomposition-flask of about 400 c.c. capacity provided with a condenser and connected with the drying-tubes *a*, *b*, and *c* and with the weighed soda-lime tubes *d* and *e*; * *f* is a protection tube whose left arm is filled with calcium chloride and whose right arm contains soda-lime. The first drying-tube, *a*, contains glass beads wet with concentrated sulphuric acid, while *b* and *c* contain granular calcium chloride.†

Procedure.—The substance is weighed out into the dry flask, covered with a little water in order to prevent loss of the substance and a slow current of air (free from carbon dioxide) is conducted through the apparatus in order to remove any carbon dioxide that may be present in the flask or in the three drying-tubes. While the air is being led through the apparatus, the soda-lime tubes are carefully wiped with a linen cloth and weighed. The current of air is now stopped, the weighed tubes are connected with *c*

* The right arm of the last soda-lime tube is one-third filled with calcium chloride in order to absorb the water set free by the absorption of the carbon dioxide by the soda-lime, $2\text{NaOH} + \text{CO}_2 = \text{Na}_2\text{CO}_3 + \text{H}_2\text{O}$.

† As commercial calcium chloride always contains lime which will absorb carbon dioxide, it must be saturated with this gas before the determination is made. For this purpose a dry current of the gas is conducted through the tubes for one or two minutes, the outer end of the tube is then closed by means of a glass rod within a piece of rubber tubing and the other end is kept connected with the Kipp generator for twelve hours. At the end of that time the excess of carbon dioxide is removed by passing air through the tubes for twenty minutes. The air is freed from carbon dioxide and dried by passing through two bottles containing concentrated caustic potash solution and then through a long tube filled with calcium chloride.

on the one hand and with *f* on the other, after which a slow stream of hydrochloric acid (1:3) is allowed to flow upon the substance from the funnel *T*, causing an immediate evolution of carbon dioxide gas. The stream of acid is regulated so that not more than 3-4 bubbles per second of gas pass through *a*. When all of the acid has been added, the contents of the flask are slowly heated to boiling and while the solution is boiling gently, a slow current of air is passed through the apparatus so that not more than 2-3

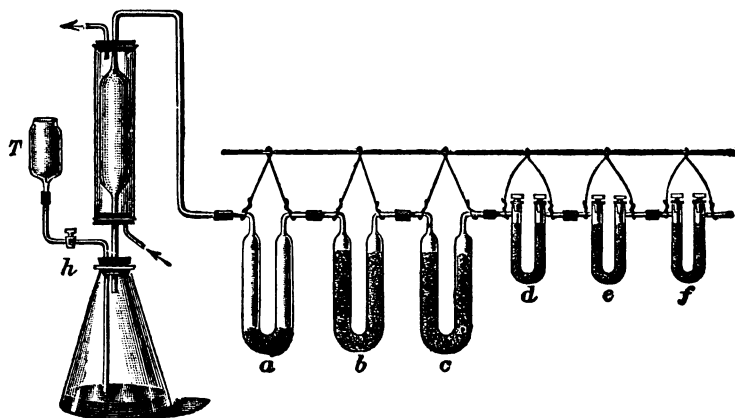

FIG. 59.

bubbles per second pass through *a*. During the whole operation, cold water is allowed to flow through the condenser; in this way the water vapor is condensed and flows back into the flask instead of reaching the sulphuric acid in *a*; consequently the contents of the latter tube seldom have to be renewed. Almost all of the carbonic acid is absorbed in the first soda-lime tube, as may be ascertained by the heat effect there. The second tube, *e*, should remain perfectly cold provided not more than 0.5-1 gm. of the carbonate was taken for the analysis. When all of the carbon dioxide has been absorbed the tube *d* quickly cools. As soon as this has taken place, the flame is removed and a somewhat more rapid current of air is conducted through the apparatus for twenty minutes more. The soda-lime tubes are then removed, stoppered, and allowed to stand in the balance case for twenty minutes, in

order to acquire the temperature of the balance; they are then weighed.

Remark.—The results obtained by this method are perfectly satisfactory. For the analysis of substances containing small amounts of carbonate, from 3–10 gms. are taken for the analysis.

If the substance contains besides the carbonate a sulphide which is decomposable with acid, a tube containing pumice impregnated with copper sulphate* is introduced between *a* and *b*, and this serves to absorb all of the hydrogen sulphide evolved.

Sulphites interfere with this determination, but the difficulty can be overcome by first decomposing the carbonate with an excess of potassium dichromate solution and adding a little dilute sulphuric acid toward the end of the operation.†

The Fresenius-Classen method is suitable not only for the determination of carbon dioxide in solid substances, but also for the analysis of carbonates in solution provided little or no free carbonic acid is present. In case considerable amounts of the latter are to be estimated, as in the case of many mineral waters, the analysis is conducted as follows:

Determination of Total Amount of Carbonic Acid in Mineral Waters.

From 3 to 4 gms. of freshly-burnt lime ‡ and the same amount

* Sixty gms. of pumice in pieces about the size of a pea are placed in a porcelain dish and covered with a concentrated solution of 30–35 gms. of copper sulphate. The solution is evaporated to dryness with constant stirring and the residue allowed to remain in the hot closet at 150–160° C. for four or five hours. At this temperature the copper sulphate is partly dehydrated and in this condition it absorbs hydrogen sulphide more readily than when in the hydrous condition. It cannot be heated higher than the above temperature, as otherwise some sulphur dioxide is formed which would be absorbed by the soda-lime.

† E. R. Marle, *J. Chem. Soc.*, 95, 1491 (1909).

‡ To prepare this lime absolutely free from carbonate, the lime is placed in a tube of difficultly fusible glass and heated in a small combustion furnace, meanwhile passing a current of dry air free from carbon dioxide over it. In this way 4 gms. of commercial lime can be freed from carbonate in one-half to three-quarters of an hour. That the carbon dioxide is actually removed can be shown at the end of that time by passing the escaping air through baryta water; there should be no turbidity. A blank experiment should always be made with this lime. If it is desired to use commercial lime

of crystallized calcium chloride* are placed in each of from four to six Erlenmeyer flasks whose necks are of such a size that they will each fit the apparatus shown in Fig. 59. The flasks are closed by means of tightly-fitting rubber stoppers and accurately weighed. A double-bored rubber stopper is taken of such a size that it will fit into the neck of each of the above flasks and through one of the holes is fitted a short glass tube which reaches about 3 cm. above the stopper and the same distance below, while through the other hole a glass tube about 50 cm. long is passed which likewise reaches about 3 cm. below the stopper. To fill the weighed flasks with the water to be analyzed, they are taken to the spring and are treated one after another as follows: The solid rubber stopper is quickly replaced by the one fitted with the two tubes, the thumb is placed over the shorter of the tubes, and the flask is dipped well below the surface of the water, but so that the longer tube still reaches into the air above. The thumb is now removed from the shorter tube, when the spring-water will pass into the flask and the replaced air will escape through the long tube. As soon as the flask is almost full, the shorter tube is again closed with the thumb, the flask is removed from the water, and the stoppers are once more quickly interchanged. To make sure that the solid stopper is not loosened while carrying the flask back to the laboratory, it is covered by a piece of parchment paper, and fastened by means of string to the neck of the flask. The flasks are then allowed to stand several days with frequent shaking, when the precipitate is allowed to settle and the flask and contents are weighed. The gain in weight represents the amount of water taken for the analysis. The supernatant liquid is quickly poured off through a folded filter, the filter is immediately thrown into the flask, and the latter is now connected with the apparatus shown in Fig. 59. The carbon dioxide is determined as in the previous process.

This method is capable of yielding excellent results provided the flasks can be filled as above described. Often, however, the spring is not easily accessible, so that the flasks must be filled by a for the determination, the amount of carbonate present is determined and an accurately weighed amount is used for the analysis.

* The addition of calcium chloride serves to decompose any alkali carbonate. This is not quantitatively decomposed by lime alone, particularly when magnesium carbonate is present.

different method and usually a small amount of carbonic acid is lost during the operation. A much more expeditious and accurate procedure which can be performed within one hour at the spring, consists in the determination of the total amount of carbonic acid present in mineral waters by measuring the volume of the gas.*

2. Gas-volumetric Determination of Carbonic Acid.

(a) Method of O. Pettersson.†

This excellent method, upon which the two following procedures are based, consists of evolving carbon dioxide from carbonates by the action of acid, collecting the gas over mercury

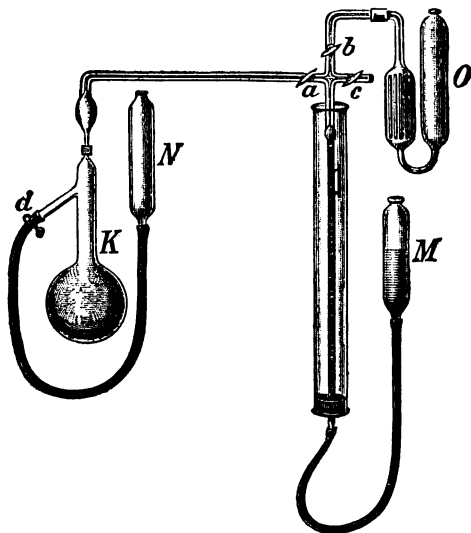

FIG. 60.

and computing its weight from its volume. Pettersson's apparatus is shown in Fig. 60, and was used by him for the determination of the carbonic acid in sea-water (Skagerrak), in carbonates, and also for the determination of carbon in iron and steel. The method

* Cf. the modified method of Pettersson on p. 393.

† Berichte, 23 (1890), p. 1402.

of determining the carbonic acid in a water containing small amounts of free carbonic acid but considerable carbonate will suffice to show how the apparatus is used. The decomposition-flask *K* is filled with distilled water up to the mark just below the side-arm (the mark is not shown in the illustration). By weighing the flask both empty and with this amount of water, the volume of the flask when filled to the mark is obtained. The flask is now filled up to this mark with the water to be examined, a small piece of aluminium wire * is thrown in, and the flask is connected with the rest of the apparatus as shown in the figure. All of the rubber tubing should be firmly fastened to the glass by means of wire. The cocks *a*, *b*, and *d* are closed, *c* is opened, and the air in the measuring-tube is removed by raising *M* until the mercury rises in the capillary up to the crossing point. After this *c* is closed, *a* is opened, *M* is brought very low, and the screw-cock *d* is slowly opened. By this means the hydrochloric acid in *N* is introduced into the flask *K*. The acid is allowed to run into the flask until the upper part of the apparatus is reached, when *d* is closed and then *a*. The air in the measuring-tube (which does not contain an appreciable amount of carbon dioxide) is removed by opening *c* and raising *M*, after which *c* is again closed. Now *a* is once more opened, *M* is lowered, and the liquid in *K* is heated by means of a flame.

A lively evolution of gas at once ensues. As soon as the measuring-tube is almost filled with the gas, *a* is closed, the flame is removed from *K*, *M* is raised until the mercury within it stands level with that in the measuring-tube, and its position in the latter is then read. At the same time the barometer reading must be noted as well as the temperature of the cold water which surrounds the measuring-tube. After this *b* is opened and *M* is raised, whereby the gas passes into the Orsat tube *O* which contains caustic potash solution (1:2). As soon as the mercury has reached the juncture of the horizontal and vertical tubes, *b* is closed and the gas is allowed to remain in the Orsat tube for three minutes. The unabsorbed gas is once more brought into the measuring-tube, taking care that none of the caustic potash solution comes with it (the latter should not quite reach the stop-cock *b*). After bringing the gas once more to the atmospheric pressure, its volume

* 0.0142 gm. aluminium evolves 20 c.c. of moist hydrogen at 720 mm. and 15° C.

as well as the temperature and barometer reading is noted. As a rule, these readings of the barometer and thermometer remain constant, otherwise it is necessary to reduce the gas volumes in each case to 0° C. and 760 mm. pressure. The difference between the two volumes represents the amount of the carbonic acid gas. The unabsorbed gas is removed through *c* and this whole operation of collecting the gas and absorbing the carbon dioxide is repeated until finally no more gas is given off from the liquid in *K*.

In case it is desired to determine the amount of carbonate in a solid substance, a smaller decomposition-flask should be used. The aluminium wire is added to the weighed substance and the apparatus is exhausted by repeatedly lowering *M*, closing *a*, opening *c*, and then raising *M*. Finally the acid is allowed to act upon the substance and the determination is carried out exactly as described above.

Computation of the Analysis.—Let us assume that from *a* gms. of substance *V* c.c. of carbon dioxide were obtained, which was measured moist at *t*° C. and *B*. mm. pressure. First of all the volume is reduced to 0° C. and 760 mm. pressure by the following formula:

$$V_0 = \frac{V(B-w) \cdot 273}{760(273+t)}$$

In this formula, *w* represents the tension of aqueous vapor expressed in millimeters of mercury.

In order to compute the weight of the carbon dioxide from this volume, we start with the fact that the density of carbon dioxide is 1.529 * referred to air as unity. 1 c.c. of air at 0° and 760 mm. pressure weighs 0.001293 gm. † consequently at 0° and 760 mm.

$$1 \text{ c.c. CO}_2 \text{ weighs } 0.001293 \times 1.529 = 0.001977 \text{ gm.}$$

and *V*₀ c.c. weigh *V* × 0.001977 gm. The percentage of CO₂ in the original substance is then

$$\frac{V_0 \times 0.1977}{a} = \text{per cent. CO}_2.$$

* Cf. Lord Rayleigh, Proc. Roy. Soc., 62, 204 (1897).

† Landolt-Börnstein, Phys. chem. Tabellen.

Remark.—The addition of aluminium is absolutely necessary. By boiling an acid solution, carbonic acid is not completely

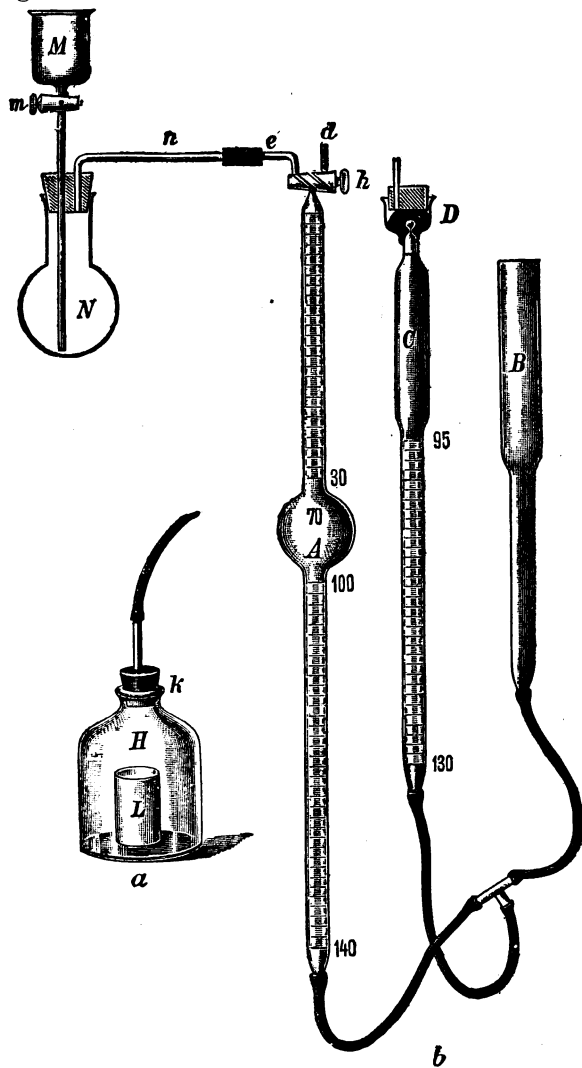

FIG. 61.

expelled; this is only effected when a different gas simultaneously passes through the solution. Formerly it was customary

to pass air through the apparatus, but Petterson accomplished the same purpose by generating hydrogen within the liquid itself.

(b) *Method of Lunge and Marchlewski.**

Lunge and Marchlewski carry out the determination according to the same principle as that of the above process; i.e., by simultaneously evolving hydrogen (aluminium and hydrochloric acid), measuring the gas, and absorbing the carbon dioxide by means of caustic potash in an Orsat tube.

The apparatus which they recommend is shown in Fig. 61, *b*. It consists of the 40-c.c. decomposition-flask *N*, the 140-c.c. measuring-tube *A*, the compensation-tube *C*, and the levelling-tube *B*; the three last are connected together as shown in the figure.

In the case of all gas-volumetric methods, the volume of the measured gas must be reduced to 0° C. and 760 mm. pressure, which ordinarily requires a knowledge of the temperature and the barometric pressure. In this method the reduction is accomplished without paying any attention to the actual readings of the thermometer and barometer by means of the compensation-tube *C*, which contains a known amount of air, viz., that amount of air which in a dry condition assumes a volume of 100 c.c. at 0° C. and 760 mm. pressure. If, therefore, this amount of air has a volume of V' at t° and atmospheric pressure P' (with the mercury at the same level in *B* and *C*), we know that this volume of any gas would be equal to 100 c.c. at 0° C. and 760 mm. pressure. By raising the levelling-tube *B* so high that V' c.c. is compressed to 100 c.c., we have accomplished the reduction in a mechanical way. If, however, there is a gas volume V'' in the measuring-tube *A* under the same pressure as that in the compensation-tube (this is the case when the mercury level is the same in *A* and *C*), we can reduce this volume to the standard conditions by simply raising *B* until the volume of the gas in *C* is just 100 c.c., taking care that the mercury remains at the same height in the tubes *A* and *C*. The volume of the gas V_0'' in *A* corresponds, therefore, to the vol-

* *Zeitschr. f. angew. Chem.*, 1891, p. 229.

ume of this gas at 0° C. and 760 mm. pressure, for it has been compressed to the same degree as the gas in C. This is apparent when we remember that at a constant temperature the product of the pressure into the volume remains a constant for any gas.

In the compensation-tube we have the volume V' at atmospheric pressure P' , and after compression the volume becomes $V'_0 = 100$ c.c. and the pressure is P_0 , from which it follows:

$$1. V'P' = V'_0P_0.$$

In the measuring-tube A, we have the volume V'' at the atmospheric pressure P' , and after compression this volume becomes V''_0 , and the pressure P_0 , so that

$$2. V'' \cdot P' = V''_0P_0.$$

By dividing equation 1 by equation 2 we have:

$$\frac{V' \cdot P'}{V'' \cdot P'} = \frac{V'_0 \cdot P_0}{V''_0 \cdot P_0}$$

or

$$V' : V'' = V'_0 : V''_0$$

and V''_0 is, therefore, the reduced gas volume that is desired.

Before using the apparatus for the determination, it is necessary to fill the compensation-tube with the correct amount of air; this is accomplished as follows:

First of all a calculation is made to determine what would be the volume of 100 c.c. of dry air measured at 0° C. and 760 mm. pressure when measured moist at the temperature of the laboratory and the prevailing barometric pressure. To illustrate, let us assume

$t = 17.5^\circ \text{C.}$; $B = 731$ mm.; $w = 14.9$ (tension of aqueous vapor), then

$$V = \frac{100 \times 760 \times 290.5}{273(731 - 14.9)} = 112.9 \text{ c.c.}$$

Accordingly 112.9 c.c. of air are introduced into the tube C by removing the stopper and lowering the levelling-tube until the mercury in the compensation-tube stands at exactly 112.9 c.c. A drop of water is added by means of a pipette, the tube is im-

mediately stoppered, and an air-tight seal is made by covering the latter with mercury. A rubber stopper containing a glass tube is then pressed down into *D*. After this the temperature and pressure may vary as much as it will; the reduced volume of the air in *C* will always be equal to 100 c.c.

Procedure for the Analysis.—About 0.03 gm. of aluminium wire, i.e., enough to furnish approximately 100 c.c. of hydrogen, is weighed out into the decomposition-flask. Such an amount of the substance to be analyzed is added, that at the most 30 c.c. of carbon dioxide will be generated, and the flask is connected with the funnel tube *M*, and capillary *n*. Connection is also made with the tube *A* after it has been completely filled with mercury by raising *B*. The air from *N* is now exhausted by lowering *B*, opening *h* so that *e* is connected with *A*, then closing *h* by turning it 90°, and carefully raising *B* until the mercury stands at an equal height in *A* and *B*; after this *h* is turned so that *A* is connected with the capillary *d*, and the air in *A* is expelled. After repeating this process three or four times until finally only two or three centimeters of air remain in *A*, *B* is lowered, the hydrochloric acid (1:3) is added to *M*, *h* is carefully opened, then *m* until 10 c.c. of the acid have run into the flask *N*, when *m* is once more closed. The carbon dioxide evolution begins at once and the mercury level quickly falls in *A*. The contents of the flask are heated to boiling over a flame and kept at this temperature until all of the aluminium has dissolved. During the whole operation the mercury level in *B* must be kept lower than that in *A*. In order to transfer the gas remaining in the flask *N* into the tube *A*, *M* is filled with distilled water, *m* is slowly opened and the water is allowed to run into *N* until the stop-cock *h* is reached, when the latter is immediately

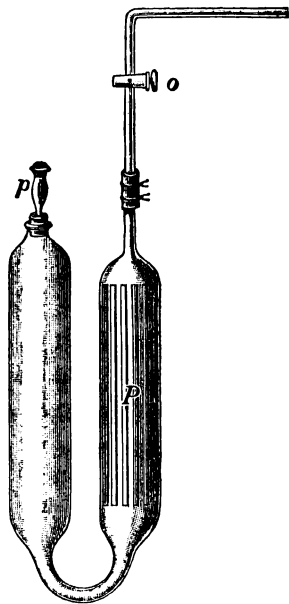

FIG. 62.

closed. The gas is then compressed by raising the tube *B* until the mercury stands at the same height in *A* and *C* and so that the level in the latter tube is exactly at the 100-c.c. mark. The reduced volume is then read. After this the capillary *d* is connected with an Orsat tube filled with caustic potash (1:2) (Fig. 62), the gas in *A* is driven over into the latter, allowed to stand there for three minutes, and again transferred to *A*, where its volume at 0° C. and 760 mm. pressure is determined as before. The difference in the two readings represents the volume of the carbon dioxide, and the per cent. can be computed according to the formula

$$\text{Per cent. CO}_2 = 0.1977 \cdot \frac{V}{a},$$

in which *V* is the amount of carbon dioxide absorbed in the Orsat tube and *a* represents the amount of substance taken for the analysis.

Remark.—This is the most exact of all methods for the determination of carbon dioxide in solid substances and is accomplished most quickly. It is particularly to be recommended where carbon dioxide determinations must be made daily, as, for example, in cement factories. It is necessary, however, to test the volume of the gas in the compensation-tube from time to time in order to make sure that it really corresponds to 100 c.c. of air under the standard conditions of temperature and pressure.

For a single determination the author prefers to dispense with the compensation-tube. In this case, however, the collected gas must be kept surrounded by water at a definite temperature, as in the Petterson method, and the temperature and pressure must be observed. It is also well to make these readings in the above-described procedure, in order to be sure that the volume in the compensation-tube has remained constant.

(c) *Method of Lunge and Rittener.**

In the decomposition flask *K*, Fig. 63, is placed 0.14–0.15 g. of calcite, or a corresponding amount of any other carbonate, and a small piece of aluminium wire, weighing about 0.015 g., is fastened to the neck of the flask. About 1 c.c. of water is allowed to flow through the funnel, *T*, and then the capillary is connected

* *Z. angew. Chem.*, 1906, 1849.

with the dry Bunte burette. The stop-cock of the funnel T is closed and the two cocks of the Bunte burette are opened. The lower stop-cock, h_1 , is now connected with the suction pump, and a partial vacuum is produced in the burette by letting the pump run two or three minutes, after which h_1 is closed. Now

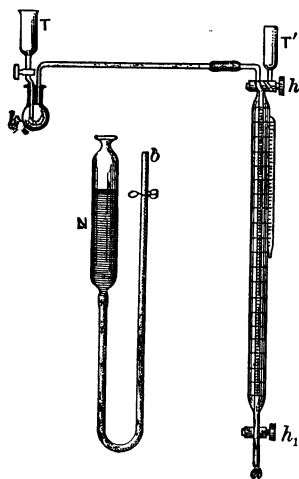

FIG. 63.

from the funnel T , hydrochloric acid (1:4) is allowed to flow upon the substance until the latter is decomposed completely; then the liquid is heated to boiling,* taking care that no water gets into the burette. Acid is then added from T until the aluminium wire is reached and the flask is heated again. The hydrogen now evolved serves to expel the last traces of carbon dioxide from the flask. As soon as all the aluminium is dissolved, hydrochloric acid is added through the funnel until the liquid reaches the stop-cock h , which is then closed at once. The lower end, a , of the burette is now connected by rubber tubing with the levelling tube N , which contains a saturated solution of common salt. By carefully opening the lower stop-cock h_1 the salt solution is allowed to rise in the burette until the liquid there stands at the same height as in the levelling tube, whereupon the stop-cock h_1 is closed. The apparatus is allowed to stand for 20–25 minutes so that the temperature of the gas will be that of the surroundings and then, by suitably raising or lowering the levelling tube with h_1 open, the burette reading is taken and the temperature as well as barometer reading noted. The funnel T † of the burette is filled with strong caustic potash

* In the case of carbonates, such as magnesite, dolomite, or siderite, they are decomposed so slowly by cold, dilute acid that it may be added much more quickly than prescribed above.

† Provided the temperature and pressure are the same as before the absorption of the CO_2 . If this is not the case, both volumes must be reduced to 0° and 760 mm. pressure before the difference is found.

solution (1:2) and a partial vacuum is produced in the burette, by lowering the levelling tube and opening the stop-cock h_1 .

The caustic potash solution is allowed to run into the burette by opening the upper stop-cock h , which is closed before the last few drops of liquid leave the funnel, and the contents of the burette mixed by shaking. By repeating the operation it is easy to tell whether the absorption of carbon dioxide has been complete. The residual volume is read with the usual precautions and the difference between the two readings* gives the volume of the carbon dioxide.

The computation of the weight of carbon dioxide is carried out exactly as described on p. 386, except that the vapor tension of the saturated salt solution only amounts to 80 per cent. of the tension of pure water at the same temperature.

Example: Weight of substance = a	Temperature = t° ,
Volume of hydrogen + air + $\text{CO}_2 = V_t$	Barometer = B mm.
Hydrogen + air = V_t'	Tension of aqueous vapor = w mm.
$\text{CO}_2 = V_t - V_t'$ Tension of salt solution = $0.8w$ mm.	

The volume reduced to 0° and 760 mm. is, therefore:

$$V_0 = \frac{(V_t - V_t') \cdot (B - 0.8w) 273}{760(273 + t)},$$

and the percentage of CO_2 in the substance (see p. 386) is,

$$\frac{V_0 \times 0.1977}{a} = \text{per cent. CO}_2.$$

For the determination of carbon dioxide in mineral waters this apparatus is not suited; for this purpose the author has modified the Pettersson apparatus as shown in Fig. 64.

(d) The Modified Method of Pettersson.

For decomposition-flasks, Erlenmeyers of from 70–200 c.c. capacity are used (according to the supposed amount of carbonic

acid) and the exact capacity of each flask is etched upon it. To determine this, each flask is provided with a tightly-fitting stopper of gray (not red) rubber containing one hole, through which the small tube *R* is introduced. The bottom of *R* is fused together, but near the bottom a small opening is blown.

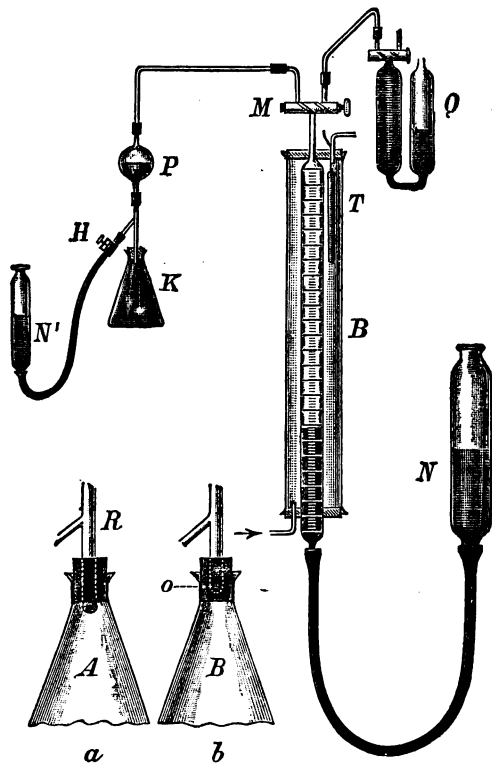

FIG. 64.

The tube *R* is shoved into the stopper until the small opening can be seen just below the bottom of the rubber stopper, and the latter is pressed as far as possible into the Erlenmeyer flask full of water. By this means some of the water passes from the flask into the tube *R*. The latter is then raised as is shown in Fig. 64, *b*, and in this way an air-tight seal is made.

The water in *R* is now removed by filter-paper and the flask and contents weighed to the nearest centigram. By deducting

from this, the weight of the empty flask together with the rubber stopper and *R*, the weight of the water, i.e. the volume of the flask, is obtained. By means of a piece of gummed paper fastened to the flask, the position of the lower edge of the rubber stopper is noted. The flask is emptied, dried, and the neck of the flask as well as the paper strip is covered with a thin coating of wax. Along the edge of the paper where the bottom of the rubber stopper came on the flask, a sharp line is cut in the wax by means of a knife and the capacity is written upon the wax with a pointed file. These lines are etched upon the flask by exposing them to the action of hydrofluoric acid for two minutes. The excess of the latter is then washed off, the flask dried, and the wax melted and wiped off with filter-paper. The flask is now ready to be used for the analysis.

About 0.04 gm. of aluminium is placed in the flask, which is then filled by dipping into the spring. When this is not possible, a piece of rubber tubing is placed in the bottle containing the water to be analyzed so that it reaches to the bottom and the water is siphoned off into the flask for two or three minutes. After this the filled flask is closed by the rubber stopper with the tube *R* so that the bottom of the stopper reaches just to the mark again. The tube *R* is raised (Fig. 64, *b*) and the spring-water within the tube is washed out by a stream of distilled water from a wash-bottle.* The flask is then connected with the bulb-tube *P* (of about 40 c.c. capacity), which in turn is connected with the measuring-tube *B*. The latter is placed in a condenser through which a stream of ordinary water constantly flows. The reservoir *N'* is now connected with the flask as shown in the figure and the screw-cock *H* is closed. All rubber connections must be tightly fastened with wire.

The bulb *P* is exhausted by lowering *N* so that the air passes into *B*, from whence it is driven into the Orsat tube *O* by turning the stop-cock *M* and raising *N*. This operation is repeated four times. The air is then removed from the Orsat tube by suction through the right-hand capillary and the stop-cock is changed to its original position as shown in the figure.

The tube *R* is now pressed into the flask so that the small opening reaches below the lower surface of the stopper.

* With water containing much carbonic acid, the flask and its contents are cooled by ice in order to prevent the glass breaking.

Usually carbon dioxide is immediately evolved and the mercury in *B* at once begins to sink slowly. The evolution of the gas is hastened by gently heating the contents of the flask. As soon as the measuring-tube is almost entirely filled with gas, the flame is removed, *M* is closed, and the contents of *B* are brought under atmospheric pressure by raising *N* until the mercury in the two tubes is at the same height, after which its position in *B* is noted. The temperature of the water surrounding *B* is taken, the barometer is read,* and the gas is driven over into the Orsat tube and allowed to remain there. This boiling, measuring, and driving over of the gas is repeated until only a slight gas evolution can be made to take place. In this way all the free carbon dioxide and a part of that present as bicarbonate is driven off, while that present as normal carbonate together with the rest of the bicarbonate remains in the flask; the liquid in the latter is usually turbid at this point owing to the precipitation of alkaline-earth carbonates. The reservoir *N'* is now filled with hydrochloric acid (1:2) and the air removed from the rubber tubing by raising *N'* high and pinching the tubing with the fingers. The levelling-tube *N* is placed in a low position, *H* is opened, and a small amount of acid is allowed to run into *K*, after which *H* is again closed. As soon as the acid reaches the contents of *K*, a lively evolution of carbon dioxide ensues, which is afterward hastened by gentle warming. When the measuring-tube *B* is nearly filled, its contents are read and driven over into the Orsat tube as before. The addition of the acid, etc., is repeated until finally the liquid in *K* clears up and the aluminium begins to evolve a steady stream of hydrogen, when the contents of the flask are heated to boiling; but care is taken that none of the liquid in the flask is carried over with the escaping gas. As soon as the aluminium has completely dissolved, *N* is lowered, *H* is opened, so that the flask is filled with the hydrochloric acid solution and the last portions of the gas are carried over into the measuring-tube *B*. As soon as the acid has reached the stop-cock *M*, this is closed, and after reading the volume of the gas as before it is led into the Orsat tube. After remaining

* If this analysis is made at the spring, it is necessary to have a sensitive aneroid barometer at hand.

there three minutes the unabsorbed gas is once more transferred to *B* and its volume subtracted from the total amount of gas which has been expelled from the water that was analyzed. This difference represents the volume of the carbon dioxide gas. By correctly adjusting the current of water flowing through the condenser, the temperature at which the gas is measured will remain constant during the entire experiment.

From the volume of the absorbed carbon dioxide the per cent. present is computed as was shown under the Pettersson method.

Remark.—By this method the author has determined successfully at the spring the amount of carbonate in a great many of the most important waters of Switzerland. For a single determination more than one hour is seldom required. The apparatus* can be readily transported. The author has travelled with an outfit during the last six years over the highest mountain passes under many disadvantages of weather, both in winter and summer, without its meeting with any accident. In order to maintain the tube *N* at any desired height it is well to fasten it to a ring-stand.

Determination of Carbonic Acid in the Air.

See Part II, Acidimetry.

Determination of Carbonic Acid in the Presence of Other Volatile Substances.

(a) *Determination of Carbonic Acid in the Presence of Chlorine.*

If it is desired to determine the amount of carbonate present in commercial chloride of lime, chlorine will be evolved with the carbonic acid on treatment of the solid substance with hydrochloric acid, so that neither the direct nor the indirect method will give correct results. The determination can easily be effected by the following procedure:

The chloride of lime is decomposed with hydrochloric acid and the gases evolved ($\text{CO}_2 + \text{Cl}_2$) are passed into an ammoniacal solu-

* It can be purchased from Bender and Hobein of Zurich.

tion containing calcium chloride.* After standing several hours in a warm place, the precipitate is filtered off quickly, washed with water, and the carbonate determined in the precipitated calcium carbonate by one of the usual methods.

Remark.—On conducting the mixture of chlorine and carbon dioxide into the ammoniacal solution of calcium chloride, the chlorine is changed into ammonium chloride with evolution of nitrogen:

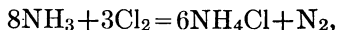

while the carbon dioxide is absorbed by the ammonia forming ammonium carbonate, and the latter is precipitated by the calcium chloride as calcium carbonate.

(b) *Determination of Carbon Dioxide in the Presence of Alkali Sulphides, Sulphites, or Thiosulphates.*

The solution to be analyzed is treated with an excess of a solution of hydrogen peroxide containing potassium hydroxide, but free from carbonate. It is heated to boiling to destroy the excess of the hydrogen peroxide, concentrated, and the carbonate determined preferably by the Fresenius-Classen method (p. 380).

DETERMINATION OF CARBON.

- (1) *In Iron and Steel.*
- (2) *In Organic Compounds.*

(1) DETERMINATION OF CARBON IN IRON AND STEEL.

Carbon exists in two forms in iron and steel:

- (a) *As Carbide Carbon.*
- (b) *As Graphite.*

On treating an iron containing carbide carbon with dilute hydrochloric or sulphuric acid, only a part of it is evolved in the form of

* One part of crystallized calcium chloride is dissolved in five parts of water, ten parts of ammonia (sp. gr. 0.96) are added, and the mixture allowed to stand at least four weeks before using.

characteristic smelling hydrocarbons. This carbon is called by Ledebur * "hardening carbon" to distinguish it from "ordinary carbide carbon" which is left behind as a brown or gray mass when the iron is treated with dilute hydrochloric or sulphuric acid; but on boiling with strong hydrochloric acid the latter is also changed to volatile hydrocarbons.

Graphite is unattacked by acids under all circumstances.

In the analysis of iron and steel it is customary to determine directly the total carbon and the graphite, in which case the difference represents the carbide carbon.

Determination of Total Carbon.

Principle.—The carbon is oxidized to carbon dioxide, and the latter is either absorbed in a suitable apparatus or its volume is measured.

For the oxidation of the carbon a great many methods have been proposed; they can be classified as follows:

(α) Those in which the oxidation is effected with the unchanged substance itself.

(β) Those in which the greater part of the iron is removed, and the residue subjected to combustion.

The Chromic-Sulphuric Acid Method.

In this method the borings, which should be as fine as possible and free from grease, are treated with a mixture of chromic and sulphuric acids and heated to boiling. Thereby, the iron goes into solution and the carbon is oxidized to carbon dioxide. In spite of a large excess of chromic acid, however, a considerable amount of the carbon is likely to escape in the form of hydrocarbons and carbon monoxide, unless precautions are taken. To prevent such losses, Särnström † recommended leading the

* Stahl und Eisen, 1888, p. 742.

† Särnström, Berg- und Hüttenm. Ztg., 1885, 52, and Corleis, Stahl u. Eisen, 1894, 581. With ferromanganese the loss amounts to 22.5 per cent. of the total carbon, with steel 9 per cent. With ferromanganese the escaping gases contain, besides carbon dioxide and traces of heavy hydrocarbons, 18 per cent. methane, 76 per cent. hydrogen, 3 per cent. oxygen, and 2 per cent. carbon monoxide.

escaping vapors over copper oxide in a combustion tube,* 80 cm. long, which is heated in a combustion furnace. Many experiments have shown that the method of Särnström gives exact results, although objection has been raised to the long combustion tube that is required.

Corleis has succeeded in simplifying the method by showing that a very short combustion tube, filled with copper oxide, heated by a single Bunsen flame, suffices if the sample is covered with a coating of copper during the treatment with chromic and sulphuric

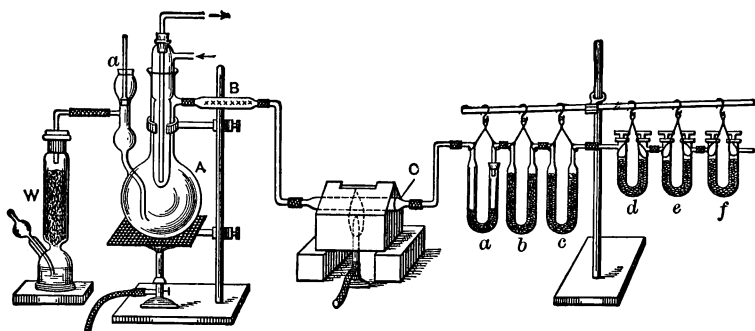

FIG. 65.

acids. In fact the use of the combustion tube is unnecessary in an ordinary steel analysis, because only 2 per cent. of the total amount of carbon present is lost in this case. In the analysis of ferromanganese, and similar alloys, however, the use of the hot tube is to be recommended.

Ledebur † even found that the results obtained with irons rich in graphite were a little too high on account of the formation of some sulphur dioxide, but this error can be overcome by passing the gases through chromium trioxide just before they enter the combustion tube.

The apparatus required is shown in Fig. 65 and consists of a Corleis decomposition flask *A* with condenser.

* A small platinum tube heated to glowing also suffices.

† Leitfaden für Eisenhütten-Laborat.

The flask is connected, as shown in the drawing, on one side with a soda-lime tower, *W*, at the bottom of which is placed a little concentrated caustic potash solution, and on the other side with a system of tubes. The tube *B* is about 10 cm. long and contains chromium trioxide between two asbestos plugs. The tube *C* is 15 cm. long, is made of difficultly fusible glass, and filled with granular cupric oxide. It is placed in a little box made of asbestos paper. The tubes *a*, *b*, *c*, *d*, *e*, and *f* are filled exactly as described on p. 380. Tubes *a*, *b*, and *c* are drying tubes, the first containing glass beads wet with concentrated sulphuric acid, the other two containing calcium chloride; *d* and *e* are glass-stoppered soda lime tubes, the upper third of the right-hand arm of each containing calcium chloride. The tube *f* is a safety tube which is not weighed, but is used to avoid any chance of carbon dioxide or moisture entering the weighed tubes from the air.

Reagents.—1. A saturated solution of ordinary chromic acid containing some sulphate. It is not advisable to use chemically-pure chromic acid for this purpose, for the latter often contains organic substances.

2. A solution of copper sulphate made by dissolving 200 gms. of the salt in 1 liter of water.

Procedure.—The ground-glass stopper *a* is removed, and through the opening 25 c.c. of chromic acid solution, 150 c.c. of copper sulphate solution and 200 c.c. of concentrated sulphuric acid are poured into the flask, *A*, and mixed. The mixture in the flask is heated to boiling and kept at this temperature for ten minutes. The flame is then removed and a current of air free from carbon dioxide is passed through the apparatus for ten minutes at the rate of about three bubbles per second. The flask is then connected with the tube *B*, the red-hot copper oxide tube, and with the U tubes,* while the current of air is continued for five minutes more. The soda-lime tubes *d* and *e* are removed, closed, and allowed to stand ten minutes in the balance room. They are opened for a moment, quickly closed, rubbed off with a piece of chamois skin or a clean linen cloth, allowed to stand five minutes in the balance-case, and then weighed.

* Corleis used phosphorus pentoxide for a drying agent, but calcium chloride is satisfactory.

By means of this preliminary boiling, traces of organic matter contained in the apparatus are removed.

After weighing the soda-lime tubes, they are connected with the apparatus again, the decomposition-flask is opened, and the weighed substance (from 0.5 to 5 gms. according to the amount of carbon present)* is introduced quickly from a glass-stoppered weighing tube, which is subsequently weighed again to determine the amount of sample. The flask is immediately closed and the copper oxide tube heated to glowing, after which the contents of the flask are slowly heated so that after from 15–20 minutes the liquid begins to boil. The solution is kept boiling for one or two hours while a slow current of air is conducted through the apparatus. The flame is then removed, and about two liters more of air are passed through the apparatus, when the soda-lime tubes are removed and subsequently weighed as before.

Since the use of the copper sulphate solution prevents the loss of more than about 2 per cent. of the total amount of carbon present, it is evident that the combustion-tube can be dispensed with for technical purposes.

Combustion of Carbon in the Wet Way and Measuring the Volume of the Carbon Dioxide.

This operation is best carried out by means of the Lunge-Marchlewski method.

The apparatus necessary is shown in Fig. 61. In this case, however, the decomposition-flask is larger and there should be a ground-glass connection between the flask and a condenser. Furthermore, a funnel-tube is fused into the neck of the flask, and runs along the side of the flask on the inside ending in a quite fine point near its bottom. The upper end of the condenser is connected with the measuring-tube by means of a capillary tube about 36 cm. long, ground to fit the condenser-tube.

Reagents.—1. A saturated, neutral solution of copper sulphate.

2. A chromic acid solution (100 gms. CrO_3 in 100 c.c. of water).

3. Sulphuric acid of specific gravity 1.65 and saturated with chromic acid.

* For cast iron 0.5 gms. suffices but for steel from 1 to 2 gm. and for wrought iron 5 gms. should be used.

4. Sulphuric acid of specific gravity 1.71, also saturated with chromic acid.

5. Pure sulphuric acid of specific gravity 1.10.

6. Commercial hydrogen peroxide solution.

Procedure.—The amount of iron or steel to be weighed out and the necessary quantities of the reagents are shown in the following table:

Per Cent. C.	Weigh Out. Grams.	c.c. Copper Sulphate Solution.	c.c. Chromic Acid Solution.	c.c. Acid Sp. Gr. 1.65.	c.c. Acid Sp. Gr. 1.71.	c.c. Acid Sp. Gr. 1.10.	c.c. H ₂ O ₂ .
Over 1.5	0.4-0.5	5	5	135	30	1
0.8-1.5	1	10	10	130	25	2
0.5-0.8	2	20	20	130	5	2
0.25-0.5	3	50	45	75	5	2
Less than 0.25	5	50	50	70	5	2

The substance is treated with the copper sulphate solution in the decomposition-flask at the ordinary temperature. Malleable iron is allowed to stand for at least one hour, while pig iron requires at least six hours. The flask is then connected with the measuring-tube, which is filled with mercury, and the air in the flask is exhausted as was described on p. 390. After this is accomplished, the levelling-tube is placed in a low position and the proper amount of the chromic acid solution is added through the funnel, followed first by the proper amount of the stronger acid and then by that of the weaker acid, after which the stop-cock in the funnel is quickly closed. The communication between the measuring-tube and the flask remains open. With the levelling-tube remaining in its low position, the contents of the flask are heated to gentle boiling, which is continued for one hour, and the flame is then removed. Now, in order to remove the last traces of carbon dioxide from the solution, the prescribed amount of hydrogen peroxide is added to the contents of the flask and the flask is afterwards completely filled with hot water until all of the gas is driven over into the measuring-tube. The stop-cock *b* is then closed, the gas is reduced to the volume corresponding to 0° C. and 760 mm. pressure as described on p. 338 and this volume read. It is then driven over into the Orsat tube and the volume of the unabsorbed gas is determined as before. The difference between the two readings represents the amount of carbon dioxide

measured under the standard conditions of temperature and pressure. If this is multiplied by the factor 0.0005392 the amount of carbon present will be obtained.

After the analysis has been completed, a blank determination must be made, using the same amounts of each reagent, in order to determine small amounts of organic matter which are invariably present in them. The amount of carbon dioxide found under these conditions must be subtracted from that obtained in the analysis proper.

*Method of Hempel.**

Hempel objects to the above procedure on the ground that by dissolving the iron in the mixture of chromic and sulphuric acids some hydrocarbon is likely to escape oxidation. He found that by dissolving iron in chromic-sulphuric acid under diminished pressure in the presence of mercury all of the carbon would be readily oxidized to its dioxide. Fig. 66 represents the apparatus used.

Reagents Required.

1. Chromic acid solution. 100 gms. of chromic acid are dissolved in 300 c.c. of water and 30 gms. of sulphuric acid, sp. gr. 1.704, are added. The resulting solution has a specific gravity of 1.2.

2. Sulphuric acid. 1000 c.c. of concentrated sulphuric acid are mixed with 500 c.c. of water and 10 gms. of chromic acid and heated for an hour in a large flask upon a sand-bath in order to completely destroy any dust, etc., that may be present. The flame is then taken away and a current of air is slowly conducted through the solution in order to remove any carbon dioxide that may have been formed.

After cooling the solution is diluted with water until it has a specific gravity of 1.704.

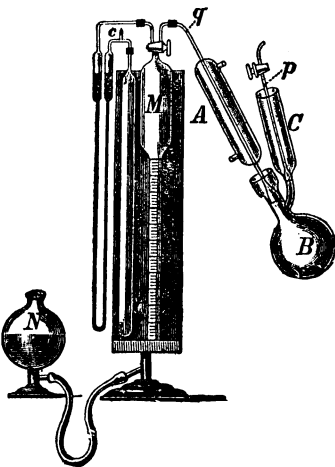

FIG. 66.

* Verhandl. d. Vereins z. Beförd. d. Gewerbeisses, 1893.

Procedure.

About 0.5 gm. of the iron or steel is placed in the decomposition-flask *B*, about 2.3 gms. of mercury are added by means of a small pipette, and the apparatus is connected together as is shown in the drawing.

By raising the levelling-bulb *N*, the measuring-tube *M* is entirely filled with mercury, the stop-cock is closed, and the apparatus is connected at *p* with a suction-pump, by means of which the air in the flask *B* is exhausted as completely as possible. In order to make sure that the ground-glass connection between the flask and the condenser is perfectly air-tight, a little water is poured into the cup there. Into the funnel *C* are placed 30 c.c. of chromic acid solution, the stop-cock at *p* is closed, and by carefully lifting the latter a little the chromic acid is allowed to run into the flask, which is immediately heated to boiling over a small flame. After boiling for half an hour, 120 c.c. of sulphuric acid are added through *C*, the stop-cock at *M* is now opened for the first time and the contents of the flask boiled for half an hour longer. (At the start only carbon dioxide is generated, in proportion to the temperature of the solution, but toward the end of the operation there is a fairly lively evolution of oxygen.) The flame is removed, the gas in the flask is carried over into *M* by pouring water into *C* and lifting the tube *p* until the gas in the flask is entirely expelled. The total volume of the gas is read, after which the carbon dioxide is absorbed in a Hempel's potash pipette and the volume of the unabsorbed gas is determined. The difference represents the amount of carbon dioxide formed by the oxidation. From this the amount of carbon present can be computed.

The measuring of the gas in this apparatus will be described more in detail in Part III, Gas Analysis.

Other methods for the determination of the volume of the carbon dioxide formed from the carbon in iron or steel are those of J. Wiborgh,* Otto Pettersson and August Smitt.†

* *Zeit. f. anal. Chem.*, XXIX (1890), p. 193.

† *Ibid.*, XXXII (1893), p. 385.

The methods already described are suitable for the determination of carbon in wrought iron, cast iron, steel, etc., but not in alloys such as ferro-silicon, ferro-chrome or tungsten steel. For such materials, the following method is used.

Wohler's Chlorine Process.*

Principle.—The sample of iron or steel is heated in a stream of pure chlorine gas whereby iron, silicon, phosphorus, and sulphur are volatilized while the carbon remains behind in the presence of small amounts of non-volatile chlorides. The silicon present as silica, due to inclosed slag, is not affected by the treatment. The residue is filtered through asbestos, the chlorides washed out by water, and the carbon burned to carbon dioxide either in the wet or in the dry way.

The principal requisite for the success of the process is *pure* chlorine. This must not contain oxygen, water, nor carbon dioxide, because these substances all tend to convert a part of the carbon into carbon monoxide, whereby low results are obtained in the carbon determination.

Procedure.—The specimen is subjected to the action of chlorine in an apparatus like that shown in Fig. 67.

B is the liter flask in which the chlorine is generated; it contains about 200 gms. of pyrolusite and 500 c.c. of concentrated hydrochloric acid. The contents of the flask are heated over a very low flame and in this way a continuous stream of chlorine is evolved. When the current begins to slacken, more hydrochloric acid is needed which is allowed to flow into the flask through a Bulk's † dropping funnel.‡ To regulate the current of gas, the

* *Z. anal. Chem.*, 8, 401 (1869), cf. A. Ledebur, *Leitfaden für Eisenhütten Laboratorien*.

† *Z. anal. Chem.*, 16, 467 (1892).

‡ The flow of the acid is regulated by raising the tube *S*. Instead of *S* a glass rod covered with rubber tubing may be used.

flask is connected with the right-angled tube, *h*, which is provided with a stop-cock and leads to a cylinder, *A*, containing caustic soda solution. If the stream of chlorine becomes too strong, the stop-cock is opened a little so that the excess of chlorine is absorbed by the sodium hydroxide. The chlorine is purified by means of the tubes *a*, *b*, *c*, *C*, and *d*; *a* contains water, *b* concentrated sulphuric acid, *c* glass beads, or pumice, moistened with sulphuric acid. *C* is a tube 40 cm. long and 1 cm. wide, made of difficultly-

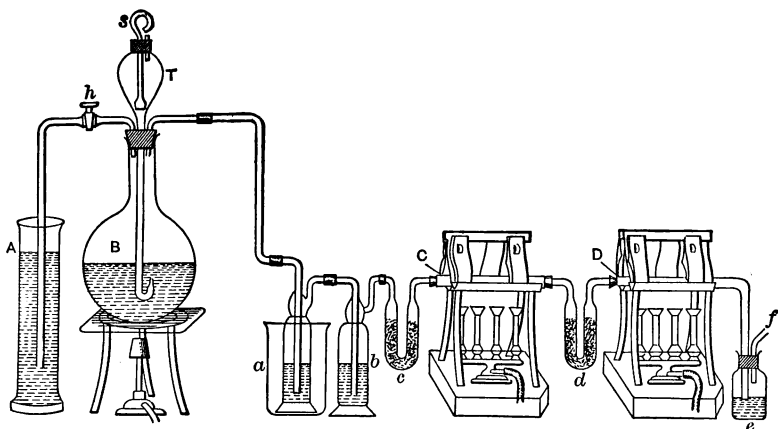

FIG. 67.

fusible glass. It contains a layer, 15 cm. long, of coarse charcoal which has previously been well ignited and cooled in a desiccator. The charcoal is placed in the tube between two loose plugs of ignited asbestos. The tube is heated to dark redness in a small combustion furnace. If the chlorine gas contains small amounts of oxygen (air) or carbon dioxide, these are changed, on coming in contact with the hot charcoal, to carbon monoxide, which is unaffected by the carbon in the iron or steel. The last traces of moisture are removed by passing the gas through the tube *d* containing glass beads moistened with concentrated sulphuric acid.

The chlorine gas is next passed into the combustion tube *D*.

This is about 40 cm. long by 1.5 cm. wide, is bent into a right angle and leads into concentrated sulphuric acid in the flask *c*. The sulphuric acid serves as a seal and prevents air from getting into the tube.

The substance, which should be as fine as possible, is sprinkled as a thin layer* upon a previously ignited porcelain boat. Of ferro-chrome about 0.5 gm. should be taken, and of ferro-silicon about 1 gm. The boat is shoved into the combustion tube and the evolution of chlorine is started as described above. The tube is not heated at all until after about twenty minutes, when the air will have all been expelled; then the heating is begun very gradually, lighting the burners one at a time from right to left. The formation and volatilization of the ferric chloride takes place at a relatively low temperature.

As soon as no more brown vapors escape from the tube, the heat is gradually raised until the tube begins to get red and then the residue in the tube is allowed to cool in the stream of chlorine.

The boat is removed from the combustion tube, and, in the case of ferro-silicon, the contents are rinsed with cold water into a beaker. From the beaker the insoluble residue is washed into an asbestos filter prepared as follows: In the funnel *R*, Fig. 68, which is about 1 cm. wide and 5 cm. long, is placed a little glass wool, and upon this a suspension of ignited asbestos fibers in water is poured until, with the aid of light suction, the filtrate comes through perfectly free from asbestos fibers. The residue is washed, on such a filter, with cold water until no chloride can be detected in the filtrate.

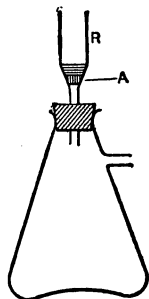

FIG. 68.

The carbonaceous residue can be oxidized in the apparatus

* This is especially important in the case of ferro-chrome, because otherwise the metal will become covered with a coating of non-volatile chromic chloride which prevents it from being acted upon by the chlorine.

shown in Fig. 65, p. 400 but in this case the flask A should contain 5 c.c. of a saturated, aqueous solution of chromic acid, and 60 c.c. of sulphuric acid, sp. gr. 1.71 which is likewise saturated with chromic acid.

In the analysis of ferro-chrome, there is always some insoluble chromic chloride in the boat which cannot be removed by washing. In this case, therefore, the substance after being heated in a stream of chlorine, is heated in an atmosphere of hydrogen, whereby the insoluble chromic chloride is converted into soluble chromous chloride. The contents of the boat are then treated exactly as described above.

Combustion of Carbon in the Dry Way.*

(a) *Solution of the Iron.*

A number of methods have been proposed for dissolving away the iron and leaving the carbon behind in the form of an insoluble residue. For this purpose a solution of potassium-cupric chloride containing 300 gms. of the double salt ($2\text{KCl}\cdot\text{CuCl}_2\cdot 2\text{H}_2\text{O}$) and 75 c.c. of concentrated hydrochloric acid to the liter has proved most satisfactory. Before using, the solution is filtered through ignited asbestos and preserved in a glass-stoppered bottle. The solution of the borings takes place very slowly unless the solution is stirred, which is best accomplished by means of a mechanical stirrer. Warming

* The dry combustion methods are much used in the steel laboratories of the United States and by the Bureau of Standards at Washington, D. C., for analyzing special samples of iron and steel which are available for distribution and serve as standard samples of known chemical composition. Furthermore, the Committee on Standard Methods of the American Foundrymen's Association (Chemical Engineer, 5, 416 (1907) have recommended the use of a dry combustion method for settling all cases of dispute.

the solution also helps, but it should never be heated above 60° to 70°. The following reactions take place:

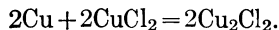
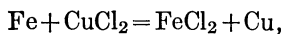

The presence of potassium chloride aids the solution of the copper, probably on account of the formation of a double salt.

The residue is filtered, dried and usually burned in a current of oxygen, the carbon dioxide being absorbed in a weighed bulb containing potassium hydroxide solution. To make sure that the oxygen used contains no carbon in any form, it is advisable to make use of a preheating tube, such as for example a short porcelain tube filled with copper oxide; this serves to convert any carbon to carbon dioxide which is then absorbed in potassium hydroxide solution before coming in contact with any of the carbon from the sample.

The combustion may take place in a porcelain or platinum tube, or in a special form of crucible, such as the jacketed crucible devised by Shimer, or the tubulated one of Gooch. These, however, are made of platinum and are expensive but Ruppel * has shown that one of nickel answers the purpose equally well.

The following directions are taken from the Report of the Committee on Standard Methods of the American Foundrymen's Association and corresponds closely to the method used by the Bureau of Standards at Washington, D. C., in preparing standard samples for distribution. They apply equally well for the determination of the total carbon in steel except that in the latter case usually 3 gms. of the sample and 200 c.c. of the potassium-cupric chloride solution are used.

* J. Ind. Eng. Chem. 1, 415 (1909).

Determination of Total Carbon in Cast Iron.

The train used consists of a pre-heating furnace containing copper oxide, followed by a bulb containing potassium hydroxide solution (sp. gr. 1.27), then one containing granular calcium chloride; the latter is connected with a ten-burner combustion furnace in which either a porcelain or platinum tube is placed. This combustion tube contains four or five inches of copper oxide between plugs of platinum gauze. The plug at the front end* of the furnace should be at about the point where the tube leaves the furnace. A roll of silver foil,† about two inches long, is placed in front of this plug. The combustion tube is connected at this end with a tube connecting anhydrous cupric sulphate, one of anhydrous cuprous chloride, and one of granular calcium chloride. A Geissler or Liebig bulb is connected with this last tube and contains potassium hydroxide solution (sp. gr. 1.27) with a prolong of calcium chloride. A calcium chloride tube is used between this last tube and the aspirator bottle to prevent any moisture working backward.

In filling the calcium chloride tubes, especially the prolong of the absorption bulb, care must be taken to press down the calcium chloride lumps well against one another, as when the tube is loosely filled, some moisture is likely to get by. A negative blank is often obtained by beginners for this reason.

Before using the apparatus, the contents of the tube should be heated for half an hour in a stream of oxygen, then the weighed absorption bulb should be connected with the train and a blank determination made. The bulb should not gain in weight more than 0.5 mgm.

One gram of the well-mixed drillings are meanwhile dissolved in 100 c.c. of the double chloride solution, and the solution eventually filtered on ignited asbestos. The beaker in which the

* In describing a combustion train it is customary to follow the direction of the flow of gas. The back or rear end is considered the end toward the gas reservoir, and the front or forward end is that nearest to the weighed potash bulb.

† The silver foil is unnecessary if the carbonaceous residue is washed free from hydrochloric acid.

solution took place is washed thoroughly with 20 c.c. of dilute hydrochloric acid (1:1), and transferred to the filter by means of more of the same acid from a wash-bottle. Finally the residue is washed on the filter with hot water until free from chlorides. The filter is then dried at a temperature between 95° and 100°.

Blair recommends the use of a perforated platinum boat for the filtering. This unquestionably works well, but where many determinations are being made it involves considerable expense. An excellent substitute can be prepared from a funnel such as was described for use with a Gooch crucible, although it is well to shorten the sides somewhat. A tight coil of copper wire is placed in the bottom of the funnel with a long free end of wire reaching down below the bottom of the stem. Loose ignited asbestos is placed upon the coil of wire, followed by a suspension of the same asbestos in water. After applying suction, the asbestos is gently tamped down with the flattened end of a stirring rod. The finished pad is about 0.75 of an inch in diameter and 0.25 of an inch thick.

The dried asbestos, with the carbon upon it, is pushed into back end of the furnace and the funnel wiped out with dry, ignited asbestos. Care should be taken that the carbon on the asbestos reaches far enough into the tube to get the full heat from the furnace. The burners under the pre-heating furnace are now lighted, the oxygen turned on and allowed to pass through the absorption bulb at the rate of three bubbles per second, but no faster. The two forward burners under the combustion tube are lighted, at first turning them low and gradually raising the heat until the tube is hot. As soon as this end of the tube is hot, the third burner from the forward end is lighted and a few minutes later the fourth burner, which should be near the forward end of the carbon residue. Light each burner in succession until finally all are lighted and turned high enough to heat the tube red hot. After twenty minutes have elapsed from the time the last burner is turned on full, the oxygen is stopped and a current of air swept through the tube at the same rate for twenty minutes longer, gradually turning down the burners under the combustion tube. The potassium hydroxide bulb at the front of the train is then detached and weighed with the usual precautions

When the Shimer or similar crucible is used for the combustion, it should be followed by a copper tube $\frac{3}{8}$ of an inch inside diameter and 10 inches long with its ends cooled by water jackets. In the center of this tube is placed a disc of platinum gauze and for three or four inches in the side toward the crucible a roll of silver foil, and for the same distance on the other side some copper oxide. The ends of this tube are plugged with glass wool and the tube heated with a fish-tail burner before the aspiration of air is started.

b. Direct Combustion of the Sample.

In most cases it is possible to effect the combustion by heating the finely divided substance itself in a current of oxygen. In fact, according to Blair,* this is true not only of ordinary steels and pig iron, but experiments have shown that with chrometungsten steels the direct method is capable of giving exact results, whereas those obtained by dry combustion after solution of the iron in potassium-cupric chloride are from 10 to 40 per cent. too low.

It has been claimed, however, that there is difficulty in burning all of the carbon on account of the sample becoming coated superficially with oxide, but according to Schneider † this may be overcome by mixing the finely divided sample with three parts of lead and one of copper.

The combustion may be carried out in a platinum tube, in one of the special forms of crucible, ‡ in a porcelain tube, or in one of fused quartz. When platinum is used it is advisable to place the drillings in a little depression of sand, the layer of which being not less than 0.25 in. deep.

According to Campbell and Gott, § if a combustion boat containing the borings of sample is placed in a cold, platinum-lined

* A. A. Blair, *The Chemical Analysis of Iron*, 7th ed. (1908).

† *Oesterr. Zeitschr.*, 1894, No. 21.

‡ P. W. Shimer, *J. Ind. Eng. Chem.*, **1**, 738.

§ *J. Ind. Eng. Chem.*, **1**, 739.

porcelain tube and then heated at a temperature of about 900°, complete combustion will take place without endangering the platinum by any spattering of the oxides formed.

It is very convenient to heat the tube by means of an electric furnace.* Such a furnace can be constructed at a cost not exceeding \$30.

Determination of Graphite.

One gram of pig iron is treated with 35 c.c. of nitric acid (sp. gr. 1.13) in a 300-c.c. beaker and heated gently until there is no further evolution of gas. By this means the carbide carbon is dissolved while the graphite is not attacked. The solution is filtered through an ignited asbestos filter and the residue washed with hot water, then with a hot solution of potassium hydroxide (sp. gr. 1.1), followed by hot water, dilute hydrochloric acid, and finally with hot water again until free from chloride. After drying at 110°, the asbestos and graphite are transferred to a combustion-tube and the carbon burned in a current of pure oxygen as described above. From the weight of carbon dioxide absorbed, the amount of graphite is calculated.

Determination of Carbon and Hydrogen in Organic Substances, according to Liebig.

(*Elementary Analysis.*)

Principle.—The organic substance is burned in air or in oxygen and the products of the combustion are passed over glowing copper oxide, which oxidizes all of the carbon to carbon dioxide and the hydrogen to water. The latter is collected in a weighed calcium chloride tube, the former in a weighed vessel which contains either caustic potash solution or dry soda-lime.

The combustion is performed.

- (a) *In an open tube;*
- (b) *In a closed tube.*

* J. Ind. Eng. Chem., 1, 741. Campbell and Gott, loc. cit. W. H. Keen, J. Ind. Eng. Chem., 1, 741. Using a quartz tube, it is well to place the finely-divided steel in an alundum boat on a bed of powdered alundum. To prevent injury of the tube by spattered oxide, the boat should be placed within a cylinder of nickel foil.

(a) Combustion in an Open Tube.

By far the greater majority of all combustions are carried out in this way.

Requirements.—1. An open tube made of difficultly-fusible glass which is from 12–15 mm. wide. The length of the tube depends upon that of the combustion-furnace; it must be 10 cm. longer than the furnace.

2. 350 gms. of coarse and 50 gms. of fine copper oxide.
3. A drying apparatus (Fig. 69, on the left).
4. A calcium chloride tube (Fig. 70).
5. A Geissler potash bulb (Fig. 71) or two soda-lime tubes (see p. 381, *d* and *e*).
6. A screw-cock.
7. Dry rubber tubing.
8. Two plates of asbestos board to protect the rubber stoppers in the two ends of the tube from the heat of the furnace.

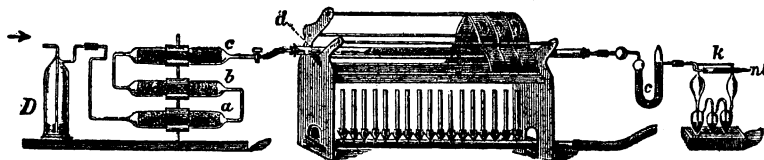

FIG. 69.

Procedure for the Combustion of Organic Substances Free from Nitrogen, Halogen, Sulphur, and Metals.

Preparation and Combustion.

1. *The calcium chloride tube* (Fig. 70) is filled from the left side as was described on p. 377, closed with a plug of glass-wool and the end of the tube fused together, as shown in the figure.* It is more practical to use a calcium chloride tube fitted with ground-glass stoppers. After filling the tube, its contents are saturated with carbon dioxide, as described on p. 380, in the foot-note.

The outside of the tube is rubbed with a piece of chamois skin or old linen, and the two ends are stoppered with short pieces of rubber tubing each containing a piece of stirring-rod. It is

*Or the tube is stoppered and an air-tight seal made by covering it neatly with sealing-wax.

allowed to stand in the balance-case for fifteen minutes and is then weighed without the stoppers.

2. *The Geissler bulb* (Fig. 71) is filled with caustic potash solution (two parts solid KOH in three parts of water) as follows: The small soda-lime tube *d* is replaced by a piece of rubber tubing, *c* is dipped into the solution of caustic potash, and the bulbs are filled two-thirds full by sucking through the rubber tubing. The

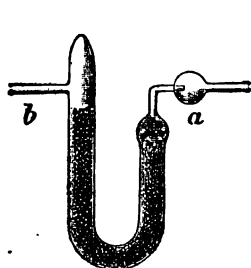

FIG. 70.

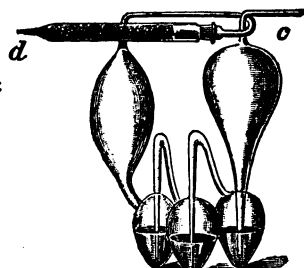

FIG. 71.

end of the tube *c* is then cleaned by means of a piece of filter-paper, the soda-lime tube *d* is again connected (its right half is filled with soda-lime and the outer half with calcium chloride), and the two ends are closed with pieces of rubber tubing each containing a piece of stirring-rod with rounded ends. The apparatus is wiped with wash-leather and weighed *without* the stoppers, after taking the same precautions as with the weighing of the large calcium chloride tube.

3. *The drying apparatus* (Fig. 69, on the left), which serves to free the air and oxygen used for the combustion from carbon dioxide and water vapor, consists of a wash-bottle, *D*, containing concentrated caustic potash solution, the soda-lime tube *a*, and the two calcium chloride tubes *b* and *c*.

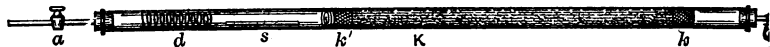

FIG. 72.

4. *The Combustion-tube* (Fig. 72), both ends of which are rounded by heating in the blast-lamp; after cooling, the tube is washed, dried, and filled as follows: First a short roll, *k*, of copper gauze is introduced into the right-hand end of the tube so that

5-6 cm. of the latter are left empty. This roll serves as a plug and must, therefore, fit tightly in the tube. A layer of coarse copper oxide, *K*, about 45 cm. long, is next added, and after this is placed another plug of copper gauze, *k'*. Finally another roll of copper gauze, *d*, about 10 cm. long and large enough to fill the tube loosely, is placed so that a space of about 10 cm. is left on the right and about 5 cm. on the left. The tube is now placed in a combustion-furnace, so that about 5 cm. extend beyond the furnace at each end, as shown in Fig. 69. The left end of the tube is closed with a tightly fitting rubber stopper through which a glass tube passes, and is connected with the drying apparatus by means of a short piece of rubber tubing. (The tube should be provided with a glass stop-cock, as is shown in Fig. 72, *a*, but which is lacking in Fig. 69.) The right end of the tube is left open for the time being.

A slow current of oxygen* is passed through the apparatus and the furnace is lighted. At first the flame is turned low and the whole tube is heated equally. Gradually the temperature is raised, until, with the tiles covering the tube, the copper oxide is at a dull-red heat.

Usually some water condenses in the right-hand end of the tube; this is expelled by carefully holding a hot tile under the tube. When all the water is removed, and when the presence of oxygen can be detected at the right end of the tube (by its igniting a glowing splinter), this end of the tube is closed with a rubber stopper through which an open calcium chloride tube is placed. The burners are now turned down and the oxygen current discontinued. All of the flames are extinguished after some time except those under the right half of the tube.

While the tube is cooling, the calcium chloride tube and the potash bulb (or soda-lime tubes) are weighed (the stoppers being replaced immediately after the weighing) and from 0.15-0.2 gm. of the substance is weighed into a porcelain or platinum boat.

If the substance is a difficultly-volatile oil it is weighed into a

* The oxygen must be free from hydrogen. Commercial oxygen often contains the latter, in which case it is necessary to pass the gas through a "preheating" furnace before using it. The gas should come from a gas-ometer, never from the bomb itself.

small glass tube open at one end. If it is readily volatile, a bulb is blown into a small capillary tube; this is weighed, the bulb is warmed, and the capillary is introduced into the liquid to be analyzed, so that the liquid rises in the bulb as it cools. The bulb is then turned so that the capillary lies in a horizontal position, the latter is warmed slightly to expel a little liquid that adheres to the sides of the tube, the end is melted together, and the tube is again weighed. Care must be taken that there is no liquid in the capillary. Everything is now ready for the combustion. The stopper is removed from the left (and now cold) end of the combustion-tube, the long copper roll is removed by means of a piece of wire with a hook in the end of it, the boat with the substance in it is placed in the tube and the copper roll right after it. Connection is made with the drying apparatus on the left and with the absorption-tubes on the right, as is shown in Fig. 69. In case the substance is a liquid, the tube containing it is placed so that its capillary is pointed towards the left, and in the case of a volatile liquid the end of the capillary is broken off with a file just before introducing it into the combustion-tube. The stop-cock between the tube and the drying apparatus is closed, the latter is connected with an air-gasometer, and the stop-cock in the drying apparatus is wholly opened, while that between the drying apparatus and the combustion-tube is opened just enough to permit two, or at the most three, bubbles of gas per second to pass through the apparatus. The two outer burners on the left are now lighted and the copper oxide spiral *d* (the copper was changed to the oxide by the ignition in oxygen) is slowly heated just to redness. The tube is now gradually heated from right to left, taking care that the gas evolution is never greater than four bubbles per second through the potash bulb; this can be easily regulated by means of the stop-cock or by turning the gas-burners. When the contents of the entire tube have been brought to redness, with the tiles in place, and the boat is empty, the combustion is usually complete. It is well, however, to pass oxygen through the hot tube until the gas can be detected at the right-hand end of the combustion train (a glowing splinter ignites at *n*).*

* To prevent moisture from getting into this tube from the air, it is well to connect it with an unweighed calcium chloride tube.

air passed through the apparatus until the oxygen is completely expelled. A little water always collects in the front (right) end of the tube, and this must be driven over into the calcium chloride tube by holding a hot tile under it. The calcium chloride tube and the potash bulbs are now removed, wiped off with a piece of chamois skin or a clean linen cloth, allowed to stand in the balance-room for twenty minutes, after which time they are weighed without the stoppers. The gain in weight represents the amount of water and carbon dioxide respectively, and from this the amount of hydrogen and carbon can be calculated as follows:

If a represents the weight of the substance, p that of the water, and p' that of the carbon dioxide, then

$$\begin{array}{l} \text{H}_2\text{O}:\text{H}_2 = p:x \quad \text{and} \quad \text{CO}_2:\text{C} = p':x' \\ 18.02:2.02 = p:x \quad \quad \quad 44:12 = p':x' \\ x = \frac{2.02}{18.02}p \quad \quad \quad x' = \frac{12}{44}p' = \frac{3}{11}p' \end{array}$$

and in per cent.

$$\frac{101}{9.01} \cdot \frac{p}{a} = \text{per cent. H} \quad \quad \quad \frac{300}{11} \cdot \frac{p'}{a} = \text{per cent. C}$$

Determination of Carbon and Hydrogen in Nitrogenous Organic Substances.

By the combustion of many organic substances containing nitrogen, especially nitroso- and nitro-compounds, oxides of nitrogen are formed which are partly absorbed in the calcium chloride tube and partly in the potash bulb, so that if such substances were analyzed according to the previous process, both the carbon and hydrogen results will be too high. If, however, an unreduced copper spiral is introduced in the front (right) end of the combustion-tube, this serves to reduce the oxides of nitrogen to nitrogen itself, and, as the latter is not absorbed, correct results will be obtained.

The copper spiral is prepared by rolling together a piece of copper gauze about 10 cm. wide, making it as large as will conveniently pass into the combustion-tube. The spiral is heated till it glows by holding it in a large gas flame, and while still hot it is thrown into a test-tube containing one or two cubic centimeters of methyl alcohol. The alcohol quickly boils away, but

some of it is oxidized to aldehyde by the hot copper oxide, and the latter is reduced completely to bright metallic copper. The spiral is taken out with a pair of crucible tongs and dried by quickly passing it through a flame a few times, and while still warm it is introduced into the front end of the combustion-tube, which has been previously burned out as described in the previous analysis.

To carry out the combustion, the stop-cock between the combustion-tube and the drying apparatus (Fig. 69) is closed, the substance introduced into the tube, and the copper oxide spiral at

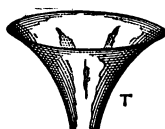

FIG. 73.

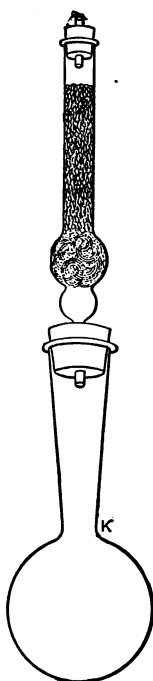

FIG. 74.



FIG. 75.

d is first heated and then the reduced spiral at the other end of the tube. Then beginning at *k* (Fig. 72), one burner is lighted after

another, until finally the entire contents of the tube are heated to dull redness and no more bubbles escape through the potash bulb. Now for the first time the stop-cock is opened somewhat and oxygen is passed through the tube until it can be detected at *n*, by a test with a glowing splinter. The flames are then gradually turned down, the oxygen replaced by air, and the analysis completed as in the previous case.

Substances hard to burn are treated somewhat differently. First of all the left end of the combustion tube (Fig. 69) is filled with the aid of the funnel *T* (Fig. 73), with finely granular, but not pulverized, copper oxide, and this is ignited in a stream of oxygen. The oxygen is then replaced by air and the tube allowed to cool until it can be held in the hand. The finely granular copper oxide is next transferred to the small flask *K*, Fig. 74, and the flask closed by inserting a tin-foil covered cork which is fitted with a calcium chloride tube. While the copper oxide in the flask is becoming perfectly cold, the substance to be analyzed is weighed into the glass-stoppered mixing tube *M*, Fig. 75. From one-sixth to one-fifth of the copper oxide in the flask is transferred to the mixing tube, which is then stoppered and its contents well shaken, whereby the substance becomes intimately mixed with the copper oxide to which it adheres. The mixture is then transferred to the combustion tube, and the mixing tube is shaken repeatedly with small portions of the remaining copper oxide in the flask until finally it can be assumed that all of the substance has been transferred to the combustion-tube. The combustion is then carried out in the usual manner.*

Combustion of Organic Substances Containing Halogens.

The analysis is conducted exactly the same as in the case of nitrogenous substances, except instead of a reduced copper spiral one of silver is used to keep back any halogen set free. The silver spiral should not be heated to redness, but only to about 180–200° C. In case a silver spiral is not at hand, a long copper spiral is used, its end reaching outside the furnace.

* For another method of conducting a combustion in an open tube, consult M. Dennstedt, Z. anal. Chem. 40, 611 (1903).

Combustion of Organic Substances Containing Sulphur.

Sulphur compounds cannot be burned in a tube containing copper oxide, for the sulphur dioxide escapes and is partly absorbed by the water in the calcium chloride tube and partly in the potash bulb, so that absolutely worthless results are obtained. Instead of the long layer of copper oxide, one of ignited lead chromate is used. The latter oxidizes the sulphur dioxide to sulphur trioxide, forming difficultly-volatile lead sulphate which remains in the tube. When lead chromate is used, the combustion must take place at a lower temperature than with copper oxide, for the former melts easily, and by adhering to the glass is likely to cause the tube to break.

Combustion of Organic Substances Containing Metals.

If the substance contains alkalies, alkaline earths, or cadmium, a part of the carbon will remain in the tube as carbonate. In this case the substance is mixed in the boat with a mixture of ten parts of powdered lead chromate and one part of potassium chromate, and the combustion is conducted as is the case when sulphur is present.

Dumas' Method for Determining Nitrogen in Organic Substances.

This determination should really be discussed under Part III, but it will be described here on account of its being an analysis by combustion.

Principle.—The substance is burned in a combustion-tube, free from air, which contains copper oxide and copper spirals exactly as in the determination of the hydrogen and carbon in substances containing nitrogen, but in this case the nitrogen evolved is *measured*.

Procedure.—This determination may be carried out in either a closed or open tube.

(a) *Determination in a Closed Tube.*

The necessary apparatus is shown in Fig. 76. The combustion-tube is closed at one end and is about 75 cm. long. It contains at *M* a layer of magnesite 15 cm. long, in pieces about the size of a pea, followed by a loose plug of ignited asbestos and then a 10-cm. layer of coarse copper oxide, *S*. The substance is added at *a* in a boat and mixed with powdered copper oxide by means of a spiral wire (cf. p. 421), after which a layer of coarse copper oxide* about 40 cm. long is added, and finally the reduced copper spiral (prepared as described on p. 419). The tube is then placed in a combustion-furnace and connected with an azotometer,† as shown in the figure, which is filled with mercury to a little above the lower end of *r*, and upon this rests a liberal amount of caustic potash solution (300 gms. KOH dissolved in a liter of water).

The experiment is begun (with the levelling-bulb low and the stop-cock of the azotometer open) by heating the left half of the magnesite layer, whereby the air in the tube is expelled by the carbon dioxide and passes through the azotometer. From time to time a test is made to see whether the air has all been expelled. The levelling-bulb is raised, and the stop-cock closed with the azotometer tube completely filled. If all the air has been replaced by carbon dioxide gas, the bubbles of gas will all be absorbed by the caustic alkali. When this is the case the flame is put out under *M*. The tube is heated first at *R* and the burners are lighted one after another toward the left until about three-quarters of the layer of coarse copper oxide is heated to a dull redness. The tube is then heated at *S* and the process is continued as in an ordinary combustion until the whole tube (with the exception of the part where the magnesite is found) is heated to a uniform temperature and finally no more nitrogen is evolved.

The heating must be accomplished so that there will be a slow but steady evolution of nitrogen. When the combustion is complete, the magnesite layer is once more heated and the nitrogen

* The copper oxide must be previously ignited, as described on p. 417.

† H. Schiff, *Berichte*, XIII, p. 885.

remaining in the tube is completely driven over into the azotometer by the carbonic acid set free. As soon as the volume of the gas in the azotometer remains constant, the experiment is ended and it remains only to measure the nitrogen.

For this purpose the azotometer together with the connecting piece of rubber tubing is removed from the combustion-tube and

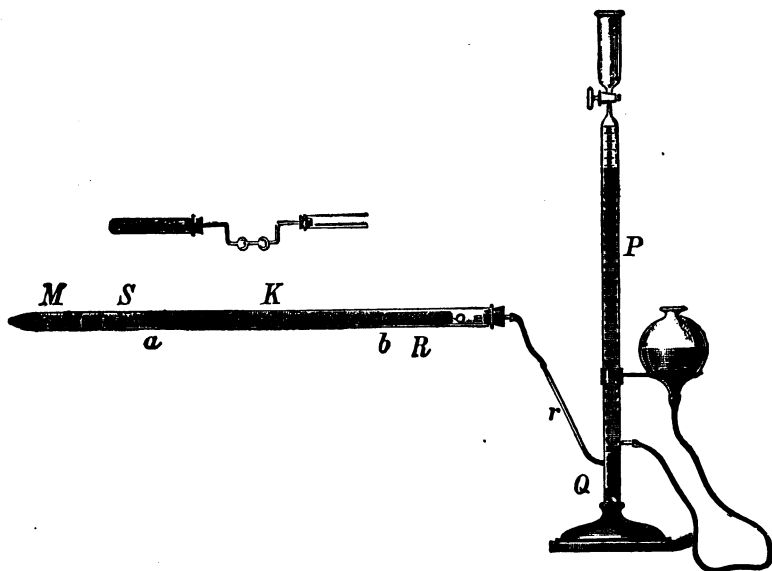

FIG. 76.

the tubing closed by means of a pinch-cock. The apparatus is then set aside for at least thirty minutes at a place where a uniform temperature prevails, after which the gas levelling-tube is raised until the solution in it stands at exactly the same height as that in the tube, when the volume is read. At the same time the barometer and thermometer * readings are noted.

The weight of the nitrogen present is computed as follows:

Let us assume that a gms. of the substance were used for the

* An accurate thermometer should hang at the side of the azotometer.

analysis and V c.c. of nitrogen were obtained at t° C. and B mm. barometric pressure. In order to obtain the weight of the nitrogen, its volume must be first reduced to 0° C. and 760 mm. pressure. If the gas had been measured over pure water the formula

$$V_0 = \frac{V(B_0 - w) \cdot 273}{760 (273 + t)}$$

would hold in which B_0 represents the observed barometer reading reduced to a temperature of 0° and w is the tension of water vapor measured in millimeters of mercury. The nitrogen, however, was not measured over pure water but over a solution of potassium hydroxide, and the vapor tension of this solution is less than that of pure water. In fact, with potassium hydroxide of the concentration used, the diminution of the vapor tension as compared with pure water almost exactly compensates the correction which would be applied in reducing the barometer reading to 0° . Consequently the following formula holds with sufficient accuracy:

$$V_0 = \frac{V(B - w) \cdot 273}{760 (273 + t)}$$

As 1 c.c. of nitrogen at 0° and 760 mm. has been found to weigh 0.0012506 gm.,* then V_0 c.c. of nitrogen will weigh

$$0.0012506 \times V_0 \text{ gms.}$$

and in per cent.,

$$a = 0.0012506 \cdot V_0 = 100 : x$$

$$x = \frac{0.12506 \cdot V_0}{a}$$

* Cf. Nitrogen under Gas Analysis.

If the value for V_0 is inserted in this last equation, and the constant values are united, it becomes

$$x = 0.04493 \frac{V(B-w)}{(273+t) \cdot a} = \text{per cent. N.}$$

(b) *Determination of Nitrogen in an Open Tube.*

The determination is carried out in practically the same way as before, except that in this case the carbon dioxide is generated outside of the tube. If the combustion-tube of Fig. 76 is imagined to be cut off at M and connected by means of the two-bulbed tube with a long test-tube, as shown in the upper part of the figure, the apparatus necessary for this determination will be seen.

The long test-tube contains sodium bicarbonate, and it is covered with a piece of copper gauze in order that it may be heated more uniformly.

At S is a long copper oxide spiral, this is followed by a copper boat containing the substance mixed with powdered copper oxide, then the long layer of coarse copper oxide, and finally the reduced copper spiral. After the connection with the azotometer has been made, the tube containing the sodium bicarbonate is heated and the air removed from the combustion-tube by means of the carbon dioxide evolved. The greater part of the water that is simultaneously set free collects in the two-bulbed tube. Otherwise the procedure is exactly the same as in the former case.

Remark.—The advantage of this method over the former lies in the fact that the combustion-tube can be used for a large number of nitrogen determinations without refilling it each time.

With difficultly-combustible substances the author prefers to work with the closed tube, for in this way it is possible to get a very intimate mixture of the substance with the powdered copper oxide.

OXALIC ACID, $\text{H}_2\text{C}_2\text{O}_4$. Mol. Wt. 90.02.

Forms: Calcium Oxide, CaO , and Carbon Dioxide,
 CO_2 .

Determination as Calcium Oxide.

The neutral solution of an alkali oxalate is treated with a few drops of acetic acid, heated to boiling, and precipitated with boiling calcium chloride solution. After standing twelve hours the precipitate is filtered off, washed with hot water, ignited wet in a platinum crucible, and from the weight of the calcium oxide the amount of oxalic acid is calculated as follows:

$$\text{CaO}:\text{H}_2\text{C}_2\text{O}_4 = p:x$$

$$x = \frac{\text{H}_2\text{C}_2\text{O}_4}{\text{CaO}} \cdot p.$$

Determination as Carbon Dioxide.

Principle.—The method is based upon the fact that oxalic acid on being heated with manganese dioxide and dilute sulphuric acid is quantitatively oxidized to carbon dioxide:

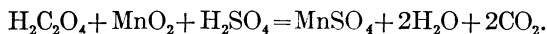

Procedure.—A weighed amount of the oxalate is treated with one and a half times as much manganese dioxide (free from carbonate) either in the apparatus shown on page 376 (Fig. 58), or in that of Fresenius-Classen (Fig. 59, p. 381). The procedure is exactly the same as was described for the determination of carbon dioxide. If p gm. of carbon dioxide were found, this corresponds to

$$p \cdot 1.023 \text{ gm.} = \text{Oxalic Acid, } \text{H}_2\text{C}_2\text{O}_4.$$

Remark.—Both methods give good results, but oxalic acid can be much more conveniently determined by a volumetric process (see Part II, Volumetric Analysis).

The free acid crystallizes with two molecules of water and its molecular weight is then 126.05. This should be borne in mind in determining the purity of a commercial sample.

BORIC ACID, HBO_2 .* Mol. Wt. 44.01.

Determination as Boron Trioxide, B_2O_3 , by the Method of Rosenblatt-Gooch.†

Principle.—Alkali and alkaline-earth borates, on being distilled with absolute methyl alcohol (free from acetone) and acetic acid, give up all their boron in the form of methyl borate, a liquid which boils at 65°C . If the methyl borate is passed over a weighed amount of lime in the presence of water, it is completely saponified:

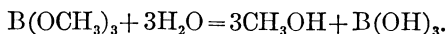

The boric acid set free combines with the lime to form calcium borate. If the paste of water and lime is evaporated to dryness, the gain in weight, therefore, represents the amount of B_2O_3 .

Procedure.—About 1 gm. of the purest lime ‡ obtainable is ignited to a constant weight over the blast-lamp, and as much of it as possible is transferred to the dry Erlenmeyer flask (Fig. 77) which serves as a receiver. The crucible, with some of the lime adhering to it, is placed in a desiccator and set aside for the present.

The lime in the flask is slaked by the careful addition of about 10 c.c. of water, and the flask is connected with the distillation-flask as shown in the figure.§

The aqueous solution of the alkali borate (containing not more than 0.2 gm. B_2O_3) is treated with a few drops of either litmus or lakmoid solution, and hydrochloric acid is added drop by drop until the solution turns red. A drop of dilute sodium hydroxide is added and then a few drops of acetic acid.|| The slightly acid

* This is the formula of meta-boric acid.

† Zeit. f. anal. Chem., 27 (1887, pp. 18, 364).

‡ Instead of lime, Gooch and Jones use 4 to 7 gms. of sodium tungstate which is fused with about 0.5 gm. WO_3 in a platinum crucible to expel any carbonic acid. The fused mass is cooled and weighed.

§ To permit the escape of air from the flask, a cut is made in the side of the cork stopper, at s.

|| It is absolutely necessary to neutralize the greater part of the alkali with hydrochloric acid and then the last of it with acetic acid. If the alkali were all neutralized with acetic acid, little or none of the boric acid would pass over into the receiver during the subsequent distillation with alcohol.

solution, prepared in this way, is added by means of the funnel *T* to the pipette-shaped retort, *R*, of about 200 c.c. capacity. The funnel is washed three times by the addition of 2 or 3 cubic centimeters of water and the stop-cock is closed. The liquid is distilled by placing *R* in a paraffin bath at not over 140° C., and the distillate collected in the Erlenmeyer flask containing the lime. When all of the liquid has distilled over, the paraffin bath is lowered, and after *R* has cooled somewhat, 10 c.c. of methyl alcohol (free from acetone) are added through the funnel and the contents of *R* are again distilled off. This process is repeated three times.

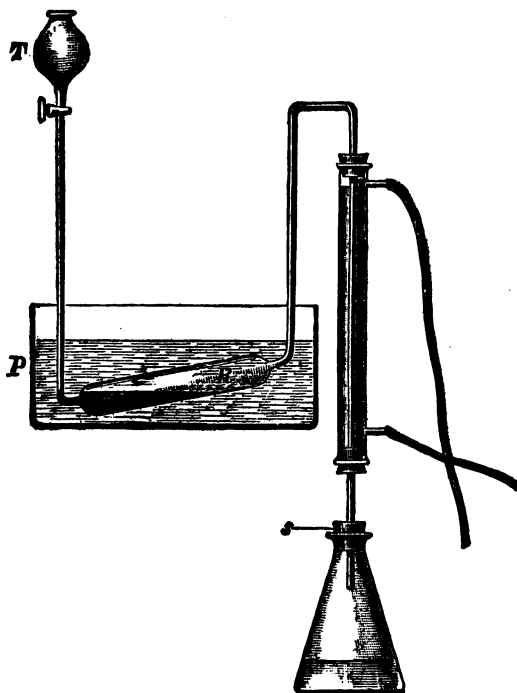

FIG. 77.

Then 2-3 c.c. of water are added to the retort, also a few drops of acetic acid until the liquid becomes distinctly red again,* and the distillation with 10 c.c. of methyl alcohol is repeated

* By the repeated distillation, the contents of the retort become alkaline, as shown by the blue color of the solution.

three times more. At the end of this time all of the boric acid will be found in the receiver.* The stoppered flask is thoroughly shaken and allowed to stand for an hour or two in order to make sure that all of the methyl borate is saponified. The contents of the receiver are then poured into a platinum dish of about 200 c.c. capacity and evaporated on the water-bath to dryness at as low a temperature as possible. During this process the alcohol must not be allowed to boil under any circumstances. Then, in order to remove the small amount of lime that remained adhering to the sides of the flask, a few drops of dilute nitric acid are added to the receiver, and, by carefully inclining the flask, its entire inner surface is wet by the acid, after which the contents are washed into the platinum dish and evaporated to dryness again. This time the water in the bath may boil, as there is now no danger of losing the boric acid, the alcohol being all removed by the first evaporation. The residue in the dish is then gently ignited over a small flame in order to destroy the calcium acetate† present; it is allowed to cool and is transferred by means of a little water to the crucible in which it was originally weighed. The dark-colored lime and carbon remaining on the sides of the dish are dissolved in a little nitric or acetic acid and washed into the crucible. The contents of the latter are evaporated to dryness on the water-bath, and, with the cover upon it, the crucible is ignited at first gently and finally more strongly until a constant weight is obtained. The increase in weight represents the amount of B_2O_3 .

Remark.—This method affords faultless results, even in the presence of considerable amounts of other salts. Free halogen hydride or sulphuric acid must not be present, for these acids form compound ethers with the methyl alcohol and distil over with the boric acid, with which they would be weighed. Instead of using lime in the receiver, the methyl borate can be distilled into a dilute solution of ammonium carbonate, and the latter evaporated with slaked lime in a platinum dish immediately after the distillation. The author, however, prefers the above method.

* When the distillation is over, the retort should be removed from the paraffin bath, by lowering the latter. If this is not done, the retort is likely to break when the paraffin solidifies.

† Due to the excess of the acetic acid added.

If one possesses a large platinum crucible (with a capacity of from 80 to 100 c.c.), the first evaporation can take place in this and it is then advisable to place the crucible within a ring-shaped copper or tin tube through which steam passes (Fig. 17, page 32). In this way the calcium acetate does not creep up over the sides of the dish, and there is no danger of any bumping.

Determination of Boric Acid in Silicates, Enamel, etc.

The finely-powdered substance is fused with four times as much sodium carbonate, the melt is extracted with water, and the aqueous solution containing the boric acid* is evaporated to a small volume, acidified with acetic acid, and, without regard to any separation of silica, the solution is transferred to the Gooch retort and analyzed as above directed.

Remark.—This determination can be performed in the presence of fluorine provided acetic and not nitric acid is used to set free the boric acid; but, for that matter, it is in no case advisable to use nitric acid and it is not permissible when chlorides are present.

Determination of Boric Acid in Mineral Waters.

If the water contains considerable boric acid (0.1 gm. or more of B_2O_3 in a liter), a weighed amount (from 200 to 300 c.c.) is evaporated to a small volume, † the precipitated calcium and magnesium carbonates are filtered off, the filtrate concentrated, slightly acidified with acetic acid, and analyzed as described on page 428.

If the water contains only a little boric acid, as is true in the great majority of cases, a large amount must be taken for the determination. From 10 to 15 liters are evaporated in a large porcelain dish to about 1 liter,* the deposited salts are filtered off (these never contain any borate), washed thoroughly with hot water, and the filtrate and washings are evaporated on the water-bath until a moist residue is obtained. If this residue does

* Sometimes the insoluble residue contains appreciable amounts of boric acid. In the method given under Volumetric Analysis, this fact will be taken into consideration.

† If the water reacts alkaline, it is at once evaporated; otherwise enough sodium carbonate solution is added to make it so.

not amount to more than 5 or 6 gms. it is redissolved, acidified with acetic acid, transferred to the Gooch retort, and distilled as described on page 428. Usually a larger residue is obtained, such that it cannot be conveniently analyzed directly, in which case the boric acid is extracted from it. For this purpose the residue is acidified with a little hydrochloric acid, thoroughly stirred with absolute alcohol, and by means of more of the latter it is transferred to a flask, corked up, and allowed to stand twelve hours with frequent shaking. The boric acid will then be found in the alcoholic solution. The residue is filtered off, washed with 96 per cent. alcohol, diluted largely with water, 1 gm. of sodium hydroxide is added, the alcohol distilled off (see Remark), and the liquid evaporated until a moist residue is obtained. This is again acidified with hydrochloric acid and the above extraction with alcohol, and subsequent distillation of the alcohol, after the addition of water and 1 gm. of sodium hydroxide, is repeated. If the residue now obtained is not too large, it is gently ignited in order to destroy the organic matter; after extracting with water, the carbonaceous residue filtered off, and the filtrate is acidified with hydrochloric acid. It is then made slightly alkaline with sodium hydroxide, after which just enough acetic acid is added to make the solution react acid again. The solution thus prepared is analyzed as described on page 428.

Remark.—Unless a large amount of water and the sodium hydroxide are added, some of the boric acid will be volatilized with the alcohol. It is always best to test the alcoholic distillate for boric acid as follows: A few pieces of turmeric root are extracted with alcohol, 2–3 drops of the yellow solution are placed in a porcelain dish, the alcoholic solution to be tested for boric acid and a few drops of acetic acid are added, after which the solution is diluted with water and evaporated to dryness on the water-bath. According to F. Henz, if as much as $\frac{1}{1000}$ mgm. of boric acid is present, a faint but distinct coloration will be evident, while the presence of $\frac{2}{1000}$ mgm. will cause a strong reddish-brown coloration, which on being treated with sodium hydroxide is turned to the characteristic blue-black color.

If boric acid is found in the alcoholic distillate, it must be again treated with water and sodium hydroxide, and the alcohol once more distilled off.

MOLYBDIC ACID, H_2MoO_4 . Mol. Wt. 162.02.

The determination of molybdic acid has already been considered on page 284.

TARTARIC ACID, $H_2C_4H_4O_6$. Mol. Wt. 150.05.

The composition of free tartaric acid as well as that of the tartrates is determined by an elementary analysis, see page 414 *et seq.*

META- AND PYROPHOSPHORIC ACIDS.

These acids are changed to phosphoric acid and determined as described on page 434.

IODIC ACID, HIO_3 . Mol. Wt. 175.93.

Form: Silver Iodide, AgI.

For the determination of iodic acid as silver iodide, the solution of the alkali iodate is acidified with sulphuric acid, and sulphurous acid is added until the solution, which at first becomes yellow on account of the separation of iodine, is again colorless. After this an excess of silver nitrate and a considerable amount of nitric acid are added. The solution is heated to boiling and the precipitated silver iodide determined as described on page 330.

It is not permissible to change the iodate to iodide by ignition, for the decomposition takes place at a temperature above that at which the iodide itself begins to volatilize. The transformation is therefore not quantitative. This is especially true of sodium iodate, which is only changed to iodide upon heating to a white heat. Potassium and silver iodates are much more readily decomposed, but even then some iodide is lost. Both iodic and periodic acids may be more accurately determined by a volumetric process (see Part II, Iodimetry).

For the determination of the metal present in an iodate it is first changed to the chloride by repeated evaporation with concentrated hydrochloric acid:

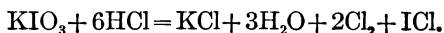

GROUP IV.

PHOSPHORIC, ARSENIC, ARSENIOS, THIOSULPHURIC,
CHROMIC, VANADIC, AND PERIODIC ACIDS.

PHOSPHORIC ACID, H_3PO_4 . Mol. Wt. 98.06.

Forms: Magnesium Pyrophosphate, $Mg_2P_2O_7$; Ammonium
Phosphomolybdate, $(NH_4)_3PO_4 \cdot 12MoO_3$; Phosphomolybdic
Anhydride, $P_2O_5 \cdot 24MoO_3$.

1. Determination as Magnesium Pyrophosphate, according to
B. Schmitz.

Until recently, it was the usual practice to precipitate phosphoric acid in the cold with "magnesia mixture" and ammonia, but according to the experiments of Neubauer* and of Gooch† it is evident that it is very difficult to obtain a pure precipitate of magnesium ammonium phosphate in this way; sometimes it is contaminated with $Mg_3(PO_4)_2$ and sometimes with $Mg(NH_4)_4(PO_4)_2$. If, however, the precipitation takes place in a hot solution, as recommended by Schmitz,‡ Järvinen,§ and Jörgensen,|| a very pure, coarsely crystalline precipitate of $Mg(NH_4)PO_4 \cdot 6H_2O$ is obtained.

Procedure.—The solution of alkali phosphate is treated with a little hydrochloric acid, a considerable excess of "magnesia mixture," ¶ and 10–20 c.c. of a saturated solution of ammonium chloride. After heating the mixture to boiling, some 2.5 per cent. ammonia is added very slowly, while constantly stirring, until a precipitate begins to form, and then the addition of the ammonia is regulated so that about four drops are added in a minute. If a milky turbidity appears, it must be redissolved in hydrochloric

* H. Neubauer, Z. angew. Chem., 1896, 439.

† F. A. Gooch, Z. anorg. Chem., 20, 135.

‡ B. Schmitz, Z. anal. Chem., 45, 512 (1906).

§ K. K. Järvinen, Z. anal. Chem., 43, 279 (1904), 44, 333 (1905).

|| G. Jörgensen, Z. anal. Chem. 45, 278 (1906).

¶ The "magnesia mixture" is prepared, according to Schmitz, by dissolving 55 gms. of crystallized magnesium chloride and 105 gms. of ammonium chloride in water adding a little hydrochloric acid and diluting to a volume of one liter.

acid. It is important that the precipitate which first forms shall be crystalline. As the precipitate increases in amount, the addition of the ammonia may be quickened, until finally the liquid smells of ammonia, after blowing away the vapors on top of the liquid. The solution is then allowed to cool, one-fifth of its volume of concentrated ammonia is added, and at the end of ten minutes more it is ready to filter. The precipitate is washed three times by decantation with 2.5 per cent. ammonia, then transferred to a filter and washed free from chloride. It is dried, ignited and weighed as described on p. 67-8. It is best to use a Munroe crucible and an electric oven.

If the weight of the precipitate is p gms., then the amount of PO_4 , s , can be computed according to the proportion.

$$\text{Mg}_2\text{P}_2\text{O}_7 : 2\text{PO}_4 = p : s$$

$$s = \frac{2\text{PO}_4}{\text{Mg}_2\text{P}_2\text{O}_7} \cdot p.$$

Solution and Reprecipitation of the Ignited Magnesium Pyrophosphate.

If it is desired to dissolve the ignited precipitate and to reprecipitate the phosphoric acid, the crucible together with its cover, is placed in a beaker, enough water is added to cover the crucible, and then an excess of concentrated hydrochloric acid. The beaker is covered with a watch-glass and its contents are heated on the water-bath, the liquid in the beaker being occasionally rotated. When the precipitate has dissolved, the heating is continued for three or four hours longer in order to make sure that the pyrophosphoric acid is completely changed to orthophosphoric acid. This change is always complete at the end of this time if the weight of the magnesium pyrophosphate was not over 0.2 gm. The time necessary to effect this transformation is proportional to the amount of nitric acid used.

After the liquid has been sufficiently heated, the crucible and its cover are removed, washed off, from 2 to 5 c.c. of magnesia mixture are added, and the solution is treated, as described above, with $2\frac{1}{2}$ per cent. ammonia, etc.

The method described on page 434 for the precipitation of phosphoric acid is not applicable when the substance contains alkaline earths or heavy metals. In such cases the phosphoric

acid should be precipitated first as ammonium phosphomolybdate and the phosphoric acid in this precipitate determined by one of the following methods.

1. Determination of Phosphoric Acid as Magnesium Pyrophosphate after Previous Precipitation as Ammonium Phosphomolybdate.

This method, first proposed by Sonnenschein, has experienced, in the course of time, a great many modifications, and of these, that of Woy* will be described, for it is one of the quickest and most accurate. It may be mentioned that the molybdate method is always applicable when the phosphoric acid is present as orthophosphate, irrespective of what metals are in solution.

Principle.—If a solution containing phosphoric acid, in the presence of ammonium nitrate and sufficient nitric acid, is treated with a slight excess of ammonium molybdate and heated just to the boiling-point, all of the phosphoric acid is immediately precipitated as yellow ammonium phosphomolybdate. According to Hundeshagen, the precipitate possesses the following composition:

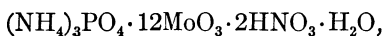

and always contains, when sufficient molybdic acid is present 24 mols. of MoO_3 to 1 mol. P_2O_5 . It never contains more molybdic acid than corresponds to the above formula, but is always some what contaminated with small amounts of the bases in solution, even when only alkalies are present. If, however, after decanting off the supernatant liquid, the precipitate is dissolved in ammonia, a little more ammonium molybdate added, and the boiling solution reprecipitated by the addition of nitric acid, it is then obtained pure.

It must also be noted that the solution may contain neither silicic acid nor organic substances † and only a small amount of

* Chem. Zeit., 21, p. 442.

† According to Hundeshagen, (Zeit. f. anal. Chem., 28, p. 164) and Eggertz (Jour. f. prak. Chem., 79, p. 496) the presence of tartaric and oxalic acids hinders the formation of the yellow precipitate, and in some cases prevents it entirely. According to Hans v. Jüptner (Oesterr. Zeit. für Berg- u. Hüttenw., 1894, p. 471) this is not the case; he even recommends that tartaric acid be added for the determination of phosphorus in iron, on the ground that it prevents the precipitate being contaminated with molybdic acid and ferric oxide.

chloride (best none at all), but there must be considerable free nitric acid present; 1 gm. of P_2O_5 requires 11.6 gms. of HNO_3 , but as much as 35.5 gm. of the latter acid does no harm.* The precipitate will dissolve somewhat if more nitric acid than the above quantity is used, but the addition of ammonium molybdate decreases the solubility of the precipitate in nitric acid; 1 gm. of ammonium molybdate makes 55.7 gms. of nitric acid inactive. The presence of ammonium nitrate not only facilitates the formation of the precipitate, but its presence is absolutely necessary, although about 5 per cent. is sufficient.

Solutions Required.

1. A 3 per cent. solution of ammonium molybdate obtained by the solution of 120 gms. commercial ammonium molybdate, $(NH_4)_6Mo_7O_{24} + 4H_2O$, in 4 liters of water (1 c.c. of this solution will precipitate 0.001 gm. P_2O_5).

2. A solution of ammonium nitrate, obtained by dissolving 340 gms. of ammonium nitrate in 1 liter of water.

3. Nitric acid, sp. gr. 1.153 (containing 25 per cent. HNO_3).

4. As wash liquid, 200 gms. ammonium nitrate and 160 c.c. of nitric acid dissolved in 4 liters of water.

Procedure.—In all cases 50 c.c. of the solution are taken, containing at the most 0.1 gm. P_2O_5 . If the solution contains more than this amount of phosphoric acid, an aliquot part is used for the analysis.

This amount of the neutral or slightly acid (HNO_3) solution is placed in a 400-c.c. beaker and to precipitate 0.1 gm. of P_2O_5 30 c.c. of ammonium nitrate solution and 10–20 c.c. of nitric acid are added and the solution is heated until bubbles begin to rise. At the same time the required amount of ammonium molybdate

* These figures are taken from experimental data furnished by Hundsagen. They do not refer to the formula on p. 436 given the yellow precipitate.—[Translator.]

solution (in this case 120 c.c.*) is likewise heated until it begins to boil, and then transferred to a separatory funnel and allowed to run in a thin stream into the middle of the phosphate solution, which is rotated while the molybdate solution is being added. The yellow ammonium phosphomolybdate is at once thrown down and the separation is quantitative. The contents of the beaker are kept in motion for about one minute more and then allowed to stand for fifteen minutes, when the clear liquid is poured through a filter, the precipitate is washed once by decantation with 50 c.c. of the wash liquid and then dissolved in 10 c.c. of 8 per cent. ammonia. To this solution 20 c.c. of the ammonium nitrate solution, 30 c.c. of water, and 1 c.c. of ammonium molybdate are added. It is heated, as before, until bubbles begin to rise, when the phosphoric acid is reprecipitated by the addition of 20 c.c. of hot nitric acid, added drop by drop through the same funnel that was used for the molybdate solution, the solution being rotated as before. The precipitate is immediately formed and is now pure. After standing ten minutes it is filtered off and dissolved in warm 2½ per cent. ammonia, after which hydrochloric acid is added until the yellow precipitate produced dissolves only slowly on being mixed with the solution. Now, according to Schmitz,† an excess of an acid solution of "magnesia mixture" is added, and the solution heated to boiling. A few drops of phenolphthalein are added, and an approximately 2.5 per cent. ammonia solution introduced as quickly as possible from a burette, while stirring the solution, until the liquid becomes slightly red in color. It is allowed to cool and then one-fifth of its volume of concentrated ammonia is added. After ten minutes, the precipitate of magnesium ammonium phosphate is ready to filter.

*AMOUNTS OF REAGENTS REQUIRED.

Amount of P ₂ O ₅ Present in Grams.	Ammonium Molybdate.	Ammonium Nitrate.	Nitric Acid.
0.1	120 c.c.	30 c.c.	19 c.c.
0.01	15 "	20 "	10 "
0.005	15 "	20 "	10 "
0.002	10 "	15 "	5 "
0.001	10 "	15 "	5 "

† *Loc. cit.*

2. Direct Determination of Phosphoric Acid as Ammonium Phosphomolybdate (Finkener).*

The precipitate produced as described under 1, having the following composition,

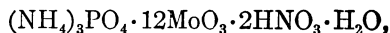

is transformed by heating for a long time at 160–180° C. into pure ammonium phosphomolybdate of the composition

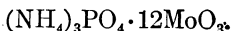

Theoretically this substance contains 3.782 per cent. of P_2O_5 .

If, therefore, the amount of yellow precipitate (dried until its weight is constant) is multiplied by 0.0378, the actual amount of P_2O_5 present should be obtained. The results obtained by Finkener, however, were accurate only when the factor 0.03794† was used. Hundeshagen,‡ on the other hand, found that the factor 0.03753 should be used, and this has been confirmed by experiments performed in the author's laboratory.§

Procedure.—The phosphoric acid is precipitated twice, according to the directions of Woy (p. 437), with ammonium molybdate; the precipitate is filtered through a Gooch crucible, washed with the prescribed mixture until no further brown coloration is produced by $\text{K}_4[\text{Fe}(\text{CN})_6]$, and dried in a current of air at 160° C. in a Paul's drying oven, until a constant weight is obtained. If the precipitate should become slightly greenish, a small crystal of ammonium nitrate and one of ammonium carbonate are added and the contents of the crucible again heated, whereby the precipitate will at once assume a homogeneous yellow color.

Remark.—The results of Hundeshagen and Steffan show that this method gives very exact results. Steffan worked precisely according to the directions of Finkener, precipitating the phosphoric acid in the cold with a 33½ per cent. solution of ammonium

* Berichte, 11 (1878), p. 1640.

† *Loc. cit.*

‡ Zeit. f. anal. Chem., XXXII (1893), p. 144.

§ A. Steffan, using 50 c.c. of a potassium phosphate solution containing 0.0989 gm. P_2O_5 , in four experiments found 0.0994, 0.0994, 0.0995, 0.0992 gm. P_2O_5 .

molybdate and filtering after standing twenty-four hours. It is, however, not necessary, as Hundeshagen has shown, to work with such a concentrated solution of ammonium molybdate; the precipitation from a hot solution with a 3 per cent. molybdate solution yields just as accurate results and the solution does not have to stand so long before filtering. Even when iron is present this method gives good results, so that it is to be recommended for the determination of phosphorus in iron and steel.

3. Determination of Phosphoric Acid as Phosphomolybdic Anhydride (Woy).

The precipitate, produced in the same way as before, is gently ignited, whereby a greenish-black residue remains of the composition $24\text{MoO}_3 \cdot \text{P}_2\text{O}_5$, with 3.946 per cent. of P_2O_5 . The precipitate is ignited as follows: Upon the bottom of a nickel crucible is placed a disk of ignited asbestos paper about 2 mm. thick, or the porcelain plate of a Gooch crucible may be used. Upon this is placed the Gooch crucible containing the precipitate, which is covered with a watch-glass and heated at first gently and finally until the bottom of the nickel crucible is at a dull-red heat. When the precipitate has become of a homogeneous, bluish-black color, it is allowed to cool in a desiccator, after which the covered crucible is weighed.

This method is rapid and gives good results in the presence of iron and aluminium.*

Determination of Phosphorus and Silicon in Iron and Steel.

The determination of these two elements is often effected in the same sample, and in all cases it is best to remove the silicic acid before precipitating the phosphoric acid.

Since phosphorus and silicon are present in the iron as phosphide and silicide, a too dilute nitric acid must not be used for dissolving the sample or there will be a loss of volatile phosphides and silicides.

* Steffan found, in the analysis of 50 c.c. of a potassium phosphate solution containing 0.0989 gm P_2O_5 , 0.0988, 0.0992, 0.0986 gm. P_2O_5 ; and in a solution of 5 gms. of iron in the form of its nitrate, 0.0099 gm. P_2O_5 , this method gave 0.0099 gm. and the same result was obtained by the method of Finkener.

Determination of the Silicon.

About 5 gms. of the iron borings, after having been washed with ether (cf. p. 236, foot-note), are placed in a 500-c.c. beaker under a good hood, covered with 60 c.c. of nitric acid (1 vol. concentrated acid, sp. gr. 1.4, and 1 vol. of water) and a watch-glass placed upon the beaker. A violent reaction at once takes place and brown vapors are evolved. As soon as the action slackens, the beaker is placed upon wire gauze and its contents boiled gently until all the iron is dissolved and no more brown vapors are evolved. The contents of the beaker are then washed into a 250-c.c. porcelain casserole, evaporated on the water-bath to a syrupy consistency, and then heated over a free flame to dryness, constantly stirring with a glass rod. Care is taken during this operation that a cake of basic ferric nitrate does not adhere to the bottom of the dish, as in this case the latter will surely break during the subsequent ignition. The dry mass should at the end be reduced to a loose powder. When this point is reached, the contents of the dish are ignited until all of the ferric nitrate is changed to oxide, which is accomplished when no more brown fumes are expelled. By this procedure all organic matter formed by the oxidation of hydrocarbons is destroyed and the silicic acid is dehydrated. After cooling, the residue is covered with 50 c.c. of concentrated hydrochloric acid and heated with constant stirring almost to the boiling-point. This dissolves the ferric oxide and phosphate, while the silicic acid remains behind.*

When all of the iron oxide has dissolved, the solution is evaporated to dryness, moistened with 2-3 c.c. of hydrochloric acid, allowed to stand for twenty minutes, after which water is added. After heating the liquid to boiling the silicic acid is filtered off through a small filter, washed with water containing hydrochloric acid and finally with pure hot water. The silica is ignited wet in a platinum crucible and weighed. The silica thus obtained usually contains ferric oxide, so that its purity must be tested in all cases. For this purpose it is covered with 1 c.c. of water, a drop of dilute sulphuric acid and 2 c.c. of pure hydrofluoric acid are added, and after evaporating on the water-bath as far as possible, the excess of

* If graphite were originally present it remains with the silica.

sulphuric acid is removed by placing the crucible on a triangle in an inclined position and carefully heating by means of a moving flame. As soon as no more vapors of sulphuric acid are given off, the contents of the crucible are more strongly ignited and the residue of ferric oxide is weighed. This amount deducted from the weight of impure silica gives the amount of pure silica, p , from which the amount of silicon, x , can be calculated as follows;

$$\text{SiO}_2:\text{Si} = p:x$$

$$x = \frac{\text{Si}}{\text{SiO}_2} \cdot p$$

and in per cent., where a is the amount of iron taken for the analysis

$$x' = \frac{100 \text{ Si}}{\text{SiO}_2} \cdot \frac{p}{a} = \text{per cent. Si.}$$

Remark.—If the impure silica was grayish colored (as is always the case when graphite is present) it is not weighed, but a little pure sodium carbonate and potassium nitrate are added to the contents of the crucible and, by fusing, the graphite is completely oxidized. The melt is placed in a small porcelain dish and dissolved in water. The solution is acidified with hydrochloric acid, evaporated to dryness on the water-bath, moistened with a little concentrated hydrochloric acid, diluted with water and filtered. The residual silica is ignited wet; a further purification of the silica is unnecessary.

Drown Method for Determining Silicon in Iron and Steel.

This method has come into very general use, and is much more rapid than the above method, though quite as exact. It is recommended by the American Foundrymen's Association for the analysis of cast iron and has been used by the Bureau of Standards at Washington, D. C., for analyzing samples of steel.

One gram of borings is treated in a platinum or porcelain dish with 20 c.c. of nitric acid, sp. gr. 1.2. When all action has ceased

20 c.c. of 50 per cent. sulphuric acid are added and the solution evaporated until copious fumes are evolved. The liquid is then cooled, diluted with 150 c.c. of water, and heated until all the ferric sulphate has dissolved. The hot solution is at once filtered, washed with dilute hydrochloric acid, sp. gr. 1.1, and then with hot water. The residue is placed in a platinum crucible without drying, ignited and weighed. The contents of the crucible are then treated with 4 or 5 c.c. of hydrofluoric acid and a few drops of sulphuric acid, evaporated to dryness, and the crucible again ignited and weighed. The difference in the two weights is the silica.

Determination of Phosphorus.

In the hydrochloric acid filtrate from the silicon determination (p. 441) all the phosphorus is present in the form of phosphoric acid. The latter is determined according to

- (a) The Acetate Method or
- (b) The Molybdate Method.

Both methods give equally good results, judging from experiments performed in the author's laboratory.

(a) The Acetate Method.

The filtrate from the silicic acid is diluted in a beaker to a volume of about 400 c.c. and ammonia is added until a permanent precipitate of ferric hydroxide is produced. The liquid is then treated with 200 c.c. of a saturated, aqueous solution of sulphurous acid and slowly heated to boiling. The precipitate of ferric hydroxide soon dissolves and the liquid assumes a dark reddish-brown color, which on further heating becomes a light green, or almost colorless. As soon as this point is reached, 10–20 c.c. of concentrated hydrochloric acid are added and a current of carbon dioxide is conducted into the colorless solution until the excess of sulphurous acid is removed. The solution is now cooled by placing the beaker in cold water, after which 1 or 2 c.c. of chlorine or bromine water is added to oxidize a part of the iron. To this solution ammonia is added very slowly with constant stirring until the greenish precipitate of ferrous-ferric hydroxide dissolves with difficulty. The addition is then continued drop by drop until a distinct red or brown precipitate is formed and then, on adding another drop of ammonia, the whole precipitate appears green.

If before this occurs the precipitate does not appear decidedly red in color, it is dissolved in a drop of two or hydrochloric acid and 1 or 2 c.c. more of chlorine or bromine water is added, and the addition of ammonia is repeated until the red and then the permanent green precipitate is obtained. Acetic acid (sp. gr. 1.04) is now added drop by drop until the green precipitate is dissolved and the remaining precipitate is quite red in color. About 1 c.c. of acetic acid in excess is added and the solution is boiled for one minute. All the phosphoric acid is then precipitated as white ferric phosphate and the excess of *ferric iron* as red basic acetate. The greater part of the iron remains in solution as ferrous salt. The solution is filtered promptly through a large filter and washed once with hot water. The precipitate filters readily and the filtrate is at first clear, but becomes turbid on standing in the air.

The precipitate adhering to the sides of the beaker is dissolved by warming with a mixture of hydrochloric acid (1:1) and 10 c.c. of bromine water. Should this not be sufficient to effect complete solution (as is usually the case) enough concentrated hydrochloric acid is added to accomplish this. The solution is then poured upon the filter containing the precipitate and the filtrate received in a small beaker. The filter is washed well with hot water and the solution is evaporated nearly to dryness to get rid of the excess of hydrochloric acid, 5 c.c. of a 50 per cent. citric acid solution are added, an equal amount of magnesia mixture and enough ammonia to make the solution faintly alkaline. When perfectly cold, one-half of the liquid's volume of strong ammonia is added and the mixture well stirred. After standing twelve hours, the precipitate is filtered off and washed with 2½ per cent. ammonia containing 2.5 gms. of ammonium nitrate in each 100 c.c. This precipitate of magnesium ammonium phosphate always contains a small amount of iron and silicic acid (the latter from the glass) so that it is dissolved in hydrochloric acid, the solution evaporated to dryness, the residue moistened with concentrated hydrochloric acid, taken up in a little water, filtered through a small filter and the residual silica washed with hot water. The filtrate, amounting to not over 20 c.c. at the most, is treated with 1 c.c. of the citric acid solution and two drops of magnesia mixture and the precipitation with ammonia is repeated as above. In

this way a precipitate is obtained which yields pure magnesium pyrophosphate on ignition.

Remark.—A. A. Blair* recommends the use of ammonium bisulphite (NH_4HSO_3) instead of sulphurous acid for the reduction of the ferric salt. Much of the ammonium bisulphite of commerce, however, contains phosphoric acid, so that it seems safer to use sulphurous acid for this purpose. Again, Blair suggests that hydrogen sulphide be passed into the solution after the excess of the sulphurous acid has been removed, in order to precipitate any arsenic as the trisulphide. The filtrate from the arsenic precipitate is heated to boiling, the excess of hydrogen sulphide expelled by means of a current of carbon dioxide, and the solution then partly oxidized as above described.

(b) *The Molybdate Method.*

The filtrate from the silica (see p. 441) is evaporated to dryness in a porcelain dish, the dry residue is dissolved in as little nitric acid as possible, 30 c.c. of ammonium nitrate solution and 10 c.c. of nitric acid are added, and the phosphoric acid is precipitated according to the procedure of Woy, p. 437, by the addition of 75 c.c. of ammonium molybdate. After decanting off the clear liquid, the precipitate is washed once by decantation with 10–20 c.c. of the prescribed wash liquid and redissolved in a little ammonia. To this solution 6 c.c. of molybdate solution and 30 c.c. of water are added; it is heated just to the boiling-point and reprecipitated by the addition of 20 c.c. of hot nitric acid. The precipitate is then analyzed by the method of Finkener (p. 439) or by that of Woy (p. 440).

1 gm.	$\text{Mg}_2\text{P}_2\text{O}_7$	=	0.27848 gm.	P
“	$(\text{NH}_4)_3\text{PO}_4 \cdot 12\text{MoO}_3$	=	0.01639	“ “
“	$\text{P}_2\text{O}_5 \cdot 24\text{MoO}_3$	=	0.01723	“ “

Remark.—According to the above directions, some difficulty is likely to be encountered at the stage where the dry residue is taken up in nitric acid. If the residue is overheated at all, it dissolves very slowly in the nitric acid owing to the formation of basic ferric salts. For this reason many chemists prefer to carry out the analysis in accordance with the directions of the American Foundrymen's Association, which are as follows:

* The Chemical Analysis of Iron, 7th edition, 1908.

A 2-gm. sample of the borings is dissolved in 50 c.c. of nitric acid, sp. gr. 1.13, and 10 c.c. of hydrochloric, sp. gr. 1.2. In case the sample contains a fairly high percentage of phosphorus, it is advisable to use half the above quantities of sample and reagents. The solution is evaporated to dryness and the residue baked until free from acid, at a temperature of about 200°. This baking serves to oxidize carbonaceous matter which otherwise interferes with the precipitation of the phosphorus. The residue is dissolved by heating it with 25–30 c.c. of concentrated hydrochloric acid; the solution is diluted to about 60 c.c. and filtered. The filtrate is evaporated to about 25 c.c., 20 c.c. of concentrated nitric acid are added, and the evaporation is repeated until a film begins to form. At this point 30 c.c. of nitric acid, sp. gr. 1.2, are added and once more the solution is evaporated until a film forms. It is then diluted with hot water to a volume of about 150 c.c. and allowed to cool somewhat. When at a temperature between 70° and 80° C., 50 c.c. of ammonium molybdate solution are added and the solution agitated for a few minutes. The precipitate is then filtered on a tared Gooch crucible which has a paper disc at the bottom. The precipitate is washed three times with 3 per cent. nitric acid and twice with alcohol. It is then dried at a temperature between 100° and 105° to constant weight. The precipitate contains 1.63 per cent. of phosphorus.

The ammonium molybdate solution used in these last directions is prepared by dissolving 100 gms. of molybdic acid in 250 c.c. of water and 150 c.c. of concentrated ammonia, stirring until all is dissolved, whereupon 65 c.c. of nitric acid, sp. gr. 1.42, are added. Another solution is prepared containing 400 c.c. of the concentrated nitric acid and 1100 c.c. of water. When the two solutions are cold, the first is poured slowly into the second with constant stirring and a few drops of ammonium phosphate solution are added. After a little ammonium phosphomolybdate precipitate has settled out, the reagent is decanted off and is ready for use. The solution does not keep very well, so that the analysis should always be carried out with a reagent that has not stood very long.

The phosphorus in iron and steel is very conveniently analyzed by a volumetric method. See Volumetric Analysis.

Determination of Phosphoric Acid in Silicates.

In the analysis of silicates (see p. 491) the phosphoric acid is found in the precipitate produced by ammonia in the filtrate from the silica together with iron and aluminium hydroxides. It is analyzed according to p. 111.

Determination of Phosphoric Acid in Mineral Waters.

The contents of a 5-6 liter flask is acidified with hydrochloric acid and evaporated to dryness, the residue is moistened with concentrated hydrochloric acid, taken up with water, and the silicic acid filtered off. The filtrate is precipitated with ammonia, by which means the phosphoric acid is usually completely thrown down in the form of phosphate of iron, aluminium, or alkaline earth. The filtered and washed precipitate is dissolved in nitric acid and the phosphoric acid present determined according to one of the molybdate methods (pp. 436-440).

Remark.—If the mineral water does not contain much iron, aluminium, or alkaline-earth metal, but is rich in phosphoric acid and the alkalis, the precipitate produced by ammonia will not contain all of the phosphoric acid. In such a case the hydrochloric acid solution from the silica is evaporated several times to dryness with nitric acid, the residue is dissolved in as little nitric acid as possible, and the phosphoric acid determined by one of the molybdate methods.

Recovery of Molybdenum Residues (H. Bornträger).*

In practice the great majority of phosphoric acid determinations are carried out according to p. 436. The acid and ammoniacal filtrates containing molybdenum are saved, and the molybdenum is recovered as follows: Into a large, wide-mouthed flask 250 c.c. of strong ammonia are placed and the molybdenum filtrates are added to this. Either immediately or after standing some time a crystalline deposit of almost pure molybdic acid is formed. When the flask is nearly full, the solution is made almost neutral, the precipitate allowed to settle, and the

* *Zeit. f. anal. Chem.*, XXXIII (1894), p. 341.

upper liquid containing only a small amount of molybdenum is poured off. The residue is poured upon a suction plate, washed once with water (not more, or the molybdic acid will dissolve) and sucked as dry as possible. The precipitate is dissolved by warming with as little ammonia as possible, leaving behind a residue of iron and aluminium hydroxides, magnesia, and silicic acid. These are filtered off and the solution diluted with distilled water until at 17° C. it has a specific gravity of 1.11 = 14° Bé. It then contains 150 gms. of ammonium molybdate in a liter. If this solution is diluted with four times as much water, a 3½ per cent. solution will be obtained.

Determination of Phosphorus in Organic Substances.

The substance is decomposed by the method of Carius. By the action of the nitric acid in the closed tube the phosphorus is oxidized to phosphoric acid and this is determined as usual.

SEPARATION OF PHOSPHORIC ACID FROM THE METALS.

1. Separation from the Metals of Groups I and II.

Hydrogen sulphide is conducted into the hydrochloric acid solution,* by which means all the members of these groups are precipitated as sulphides while the phosphoric acid remains in solution.

2. Separation from the Metals of Group III.

(a) The phosphoric acid is first precipitated as ammonium phosphomolybdate according to p. 436. In order to determine the metals, the solution containing molybdenum, but free from phosphoric acid, is evaporated with the addition of sulphuric acid to a syrupy consistency, and carefully heated over a free flame until the nitric acid is expelled. After cooling, the residue is moistened with hydrochloric acid and taken up in water. The solution is placed in a pressure-flask, saturated with hydrogen sulphide, the flask stoppered and heated for some time on the water-bath, when the molybdenum is precipitated in large flocks. After cooling, the pressure-flask is slowly opened and the molyb-

* When silver is present it is precipitated as silver chloride, filtered off, and the filtrate treated with hydrogen sulphide.

denum sulphide is filtered off. The filtrate, now free from phosphoric acid and molybdenum, is analyzed for the metals as described on pages 82 to 167.

(b) The phosphoric acid is separated as before, the filtrate is made slightly ammoniacal and saturated with hydrogen sulphide. After standing for some time the solution becomes reddish yellow in color, when the precipitate is filtered off. The metals of this group will be found in the precipitate while the molybdenum is in the filtrate in the form of its sulpho-salt.

Remark.—If nickel is present, some of it will remain in the filtrate with the molybdenum on account of the solubility of nickel sulphide in ammonium sulphide, so that method (a) will then give more accurate results.

3. Separation of Phosphoric Acid from Iron, Cobalt, Manganese, and Zinc.

In case the solution contains iron in the ferric form, it is acidified with hydrochloric acid, saturated with hydrogen sulphide, and for each gram of the mixed oxides 3 gms. of tartaric acid are added; the solution is made slightly ammoniacal and allowed to stand overnight in a stoppered flask. The precipitate contains the metals as sulphides free from phosphoric acid. It is filtered, washed with water containing ammonium sulphide, dissolved in acids, and analyzed according to pp. 150 and 156.

4. Separation from Chromic Acid.

If the solution contains free alkali or alkali carbonate it is acidified with nitric acid, then made slightly alkaline with ammonia and the phosphoric acid precipitated with "magnesia mixture" as described on page 434.

5. Separation from Calcium, Strontium, Barium, Magnesium, and the Alkalies.

Ammonium carbonate is added to the hydrochloric acid solution until a slight permanent turbidity* is produced, which is

* If only alkalies are present there will be no turbidity, and the ammonium carbonate is added until the solution is neutral.

redissolved by a few drops of hydrochloric acid. Ferric chloride is then added drop by drop until the liquid above the yellowish-white precipitate of ferric phosphate becomes distinctly brown in color. The solution is diluted with water to a volume of 300 to 400 c.c., boiled for one minute, filtered and washed with water containing ammonium acetate. In the filtrate are now found the alkaline earths and alkalis, which, after expelling the ammonium salts by igniting the residue obtained after evaporating to dryness, is analyzed in the usual way (see pages 43 and 76 ff.).

THIOSULPHURIC ACID, $H_2S_2O_3$. Mol. Wt. 114.16.

Form: Barium Sulphate, $BaSO_4$.

The aqueous solution of the alkali thiosulphate is treated with an ammoniacal solution of hydrogen peroxide, or with ammoniacal percarbonate solution, heated for some time on the water-bath, and then boiled to destroy the excess of the reagent. This solution is acidified with hydrochloric acid and the sulphuric acid formed by the above treatment is precipitated as barium sulphate. Two mols. $BaSO_4$ correspond to 1 mol. $H_2S_2O_3$.

A much better procedure for the estimation of thiosulphuric acid will be discussed under Iodimetry, Part II.

The remaining acids of this group, arsenious, arsenic, vanadic, and chromic, have been discussed under the respective metals, while periodic acid is analyzed precisely in the same way as iodic acid.

GROUP V.

NITRIC, CHLORIC, AND PERCHLORIC ACIDS.

NITRIC ACID, HNO_3 . Mol. Wt. 63.02.Forms: Nitron Nitrate, $\text{C}_{20}\text{H}_{16}\text{N}_4 \cdot \text{HNO}_3$, Nitrogen Pentoxide, N_2O_5 ; Ammonia, NH_3 ; Nitric Oxide, NO , and Volumetrically.

1. Determination of Nitric Acid as Nitron Nitrate.*

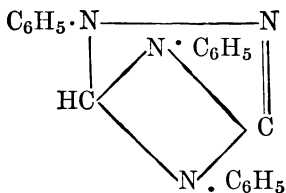
The base diphenyl-endo-anilo-hydro-triazole, $\text{C}_{20}\text{H}_{16}\text{N}_4$, or

called "nitron" for the sake of brevity, forms a fairly insoluble, crystalline nitrate, $\text{C}_{20}\text{H}_{16}\text{N}_4 \cdot \text{HNO}_3$, which can be used for the separation and quantitative estimation of this acid.

Procedure.—Enough of the substance is taken to furnish about 0.1 gm. of nitric acid, and dissolved in 80–100 c.c. of water with the addition of 10 drops of dilute sulphuric acid. The solution is heated nearly to boiling and treated with 10–12 c.c. of nitron acetate solution†, which is added all at one time. The beaker containing the solution and precipitate is kept surrounded by ice-water for about two hours. The precipitate is then transferred to a Munroe crucible and drained as completely as possible from the

* M. Busch, Ber. 38, 861 (1905). A. Gutbier, Z. angew. Chem., 1905, 494.

† The reagent is prepared by dissolving 10 gm. of nitron (which can be obtained of Merck) in 100 c.c. of 5 per cent. acetic acid. The solution usually has a reddish color, but can be kept for a long time in a dark-colored bottle without its undergoing any change.

pale yellow mother-liquor. It is washed with 10 or 12 c.c. of ice-water, added in small portions, and the precipitate drained well after each washing. The precipitate is dried at 110° to constant weight. It contains 16.53 per cent. of NO_3 .

Remarks.—The following acids interfere with the determination of nitric acid by the nitron method,—hydrobromic, hydriodic, nitrous, chromic, chloric, perchloric and the less common thiocyanic, hydroferrocyanic, hydroferricyanic, picric and oxalic acids. All of the above acids form salts with nitron which are not very soluble; these acids must, therefore, be removed from the solution before precipitating the nitric acid.

Hydrobromic acid is decomposed by adding chlorine water drop by drop to the neutral solution and boiling, until the yellow coloration entirely disappears.

Hydriodic acid is removed by adding an excess of potassium iodate to the neutral solution, and boiling until the iodine is all expelled.

Nitrous acid is removed by dropping finely powdered hydrazine sulphate into the concentrated solution (0.2 gm. of substance in 5 or 6 c.c. of water).

Chromic acid is reduced by hydrazine sulphate.

Some idea as to the relative solubilities of the various salts of nitron is obtained from the following table:

100 c.c. of slightly acid water dissolve at ordinary temperatures about

0.0099 gm. of nitron nitrate,	corresponding to 0.0017 gm. HNO_3
0.61 “ “ bromide,	“ 0.125 “ HBr
0.017 “ “ iodide,	“ 0.005 “ HI
0.19 “ “ nitrite,	“ 0.022 “ HNO_2
0.06 “ “ chromate,	“ 0.011 “ $\text{H}_2\text{Cr}_2\text{O}_7$
0.12 “ “ chlorate,	“ 0.022 “ HClO_3
0.008 “ “ perchlorate,	“ 0.002 “ HClO_3
0.04 “ “ thiocyanate,	“ 0.007 “ HCNS

These values are only approximate. The solubility of the nitrate is given a little too high and that of the other salts a little too low.

On account of the appreciable solubility of the nitrate, it was to be expected that the results would be a little low. This is not the case, however, as Busch and Gutbier have proved. It is probable that the precipitate occludes a little nitron acetate and in this way the error caused by amount left in solution is compensated.

2. Determination of Nitric Acid as Nitrogen Pentoxide.*

This method is based upon the fact that when an intimate mixture of a dry nitrate is heated with an excess of silica, nitrogen pentoxide is evolved and the amount is determined by the loss in weight.

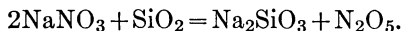

This method cannot be used when there is any other volatile substance present, which is usually the case.

3. Determination of Nitric Acid as Ammonia.

The usual method for the determination of nitric acid is to reduce it in alkaline solution to ammonia by means of aluminium, zinc, or, best, Devarda's alloy (cf. Vol. I):

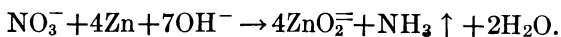

After the reduction, the solution is distilled into a known amount of acid and the excess of the acid is found by titration, or the ammonia is determined as ammonium chloroplatinate or as platinum (cf. page 58, *b* and *c*).

* Reich. Z. Chem., 1, 86 (1862).

*Procedure of Devarda.**

About 0.5 gm. of the nitrate is placed in a 600–800-c.c. Erlenmeyer flask (Fig. 78) and dissolved in 110 c.c. of water. To this solution 5 c.c. of alcohol, 50 c.c. of caustic potash (sp. gr. 1.3), and 2 to 2½ gms. of powdered Devarda's alloy are added. After

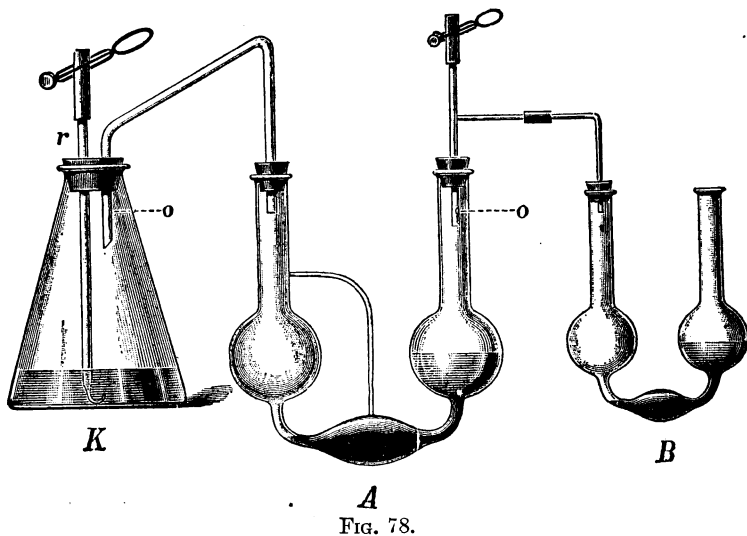

FIG. 78.

this the flask is immediately connected with the distillation apparatus as shown in the figure. The Pélilot tube, *A*, of about 250 c.c. capacity, is constructed as proposed by F. Pan-nertz.† Its left arm is connected by a curved tube with the middle bulb, so that a spurting back of the liquid is avoided. The delivery-tube (of potash glass) connecting the flask *K* with the tube *A* is about 1 cm. in diameter and is provided with a small opening at *o*, inside the flask, to prevent any of the alkaline solution being carried over with the ammonia. Twenty cubic centimeters

* *Zeit. f. anal. Chem.*, XXXIII (1894), p. 113.

† *Ibid.*, XXXIX (1900), p. 318.

of half-normal sulphuric acid are added to the tube *A* * and diluted so that the solution just reaches to each of the bulbs on the side, while 5 c.c. of the acid are placed in *B*, with a few drops of methyl orange, and diluted in the same way. The tubes *A* and *B* are connected by means of a T tube, of which the upper end is closed by a pinch-cock upon a piece of rubber tubing, so that a piece of red litmus paper may be introduced here.

When all is ready, the contents of the flask *K* are gently heated in order to start the reaction, then the flame is removed and the reaction allowed to proceed by itself. After an hour this will be shown to be complete by the cessation of the hydrogen evolution. The liquid in *K* is then slowly heated to boiling, and kept at this temperature until about half of the liquid has distilled over into *A*; this requires about half an hour. During the last ten minutes a slow current of air is passed through the tube *r*.

If the distillation has been correctly performed, all of the ammonia will now be found in *A*; no trace should reach *B*, and the red litmus paper in the T-tube should show no tinge of blue.

When the distillation is finished, the pinch-cock at *r* is opened and the flame removed. A little methyl orange is added to *A* whereby the liquid is colored red, the contents of *B* are poured in, the latter tube is washed with water that is added to *A*, and the excess of the sulphuric acid is titrated with half-normal caustic potash solution until the solution is changed to yellow. The amount of nitric acid is computed as follows:

The tubes originally contained 25 c.c. of half-normal acid, and *t* c.c. of half-normal caustic potash solution were used up in the titration; consequently the ammonia formed from 0.5 gm. of the nitrate was neutralized by $25-t$ c.c. of half-normal sulphuric acid.

Since 1 mol.† of HNO_3 (63.02 gms.) on being reduced yields 1 mol. of NH_3 , and one liter of half-normal sulphuric acid contains enough sulphuric acid to neutralize $\frac{1}{2}$ mol. of NH_3 , it is evident that 1 c.c. of the acid is equivalent to $\frac{63.02}{2000} = 0.03151$ gm.

* The tube *A* has a capacity of about 250 cubic centimeters.

† Ostwald has proposed that the molecular weight in grams of a substance be designated by the word "mol."

of nitric acid so that $25-t$ c.c. = $(25-t) \times 0.03151$ gm. of HNO_3 or $(25-t) \cdot 0.03101$ gm. NO_3 , and the per cent. of NO_3 present is

$$\begin{aligned} 0.5 : (25-t) \cdot 0.03101 &= 100 : x \\ x &= 6.202 \cdot (25-t) = \text{per cent. } \text{NO}_3. \end{aligned}$$

Determination of Nitric Acid as Nitric Oxide.

*Method of Schlösing and Grandeau, modified by Tiemann and Schulze.**

Principle.—If a nitrate is heated with ferrous chloride and hydrochloric acid, the nitric acid is reduced to nitric oxide:

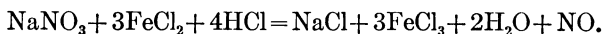

From the volume of the nitric oxide its weight is calculated.

The method of Schlösing in its original form† was not much used on account of the apparatus required; but after being modified by Grandeau ‡ it has become one of the best methods for the determination of nitric acid.

The apparatus necessary is shown in Fig. 79 and consists of a 150-c c. flask *K* fitted with a double-bored rubber stopper. Through one of the holes is passed the tube *b*, which reaches into the flask just to the lower surface of the stopper; through the other hole passes the tube *a*, § ending in a restriction about 1 mm. wide and reaching $1\frac{1}{2}$ cm. below the stopper. The tube *b* is connected by means of a piece of rubber tubing 5 cm. long, which is wired on to the tube, and is provided with a pinch-cock, with a second tube whose lower end reaches up into the measuring-tube and is covered with rubber tubing as is shown in the figure. In the same way the tube *a* is connected with a straight tube.

Solutions required.—1. A nitrate solution of known strength, prepared by dissolving in one liter of water 2.0222 gms. of recrystallized potassium nitrate that has been dried at 160°C . Fifty c.c.

* Zeit. f. anal. Chem., IX (1870), p. 401, and Berichte, VI (1873), p. 1041.

† Annales de chim. et de phys., [3], 40 (1853), 479.

‡ Grandeau, Analyse chimique appliquée à l'agriculture.

§ Grandeau used a separatory funnel instead of the tube *a*; the latter was proposed by Tiemann and Schulze.

of this solution evolve at 0° C. and 760 mm. pressure 22.41 c.c. of NO.

2. A ferrous chloride solution obtained by dissolving 20 gm. of iron (nails) in 100 c.c. of concentrated hydrochloric acid.

3. Hydrochloric acid, of specific gravity 1.1.

Procedure.—First of all, 10 c.c. of water are poured into *K* and its upper level is marked on the outside of the flask by means of

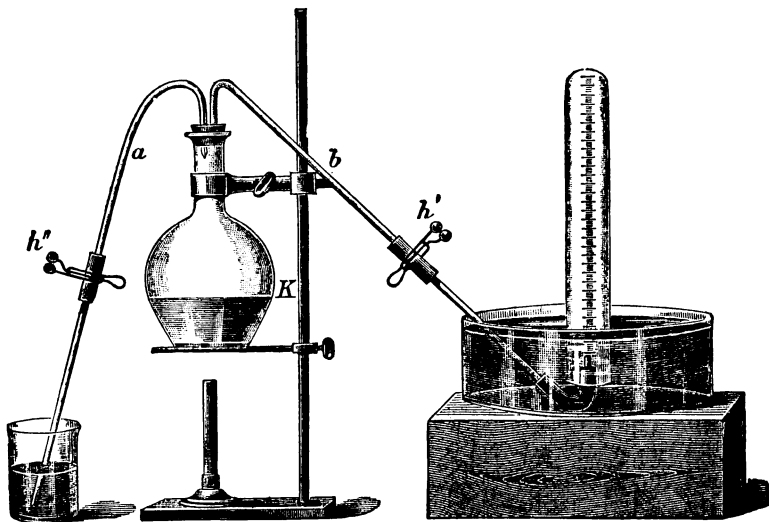

FIG. 79.

a colored pencil, then 40 c.c. more are added and its position is also marked.

The water is now poured out and exactly 50 c.c. of the standard nitrate solution is added to *K*, the stopper fitted with the two tubes is placed in the flask, and the pinch-cocks *h'* and *h''* are opened. The contents of the flask are heated to boiling with a free flame (a wire gauze is not used) until finally no more bubbles of air escape from the lower end of *b* into the bath containing boiled water. To make sure that the air is all expelled from the apparatus, the rubber tubing at *h'* is pinched with the thumb and finger, when, if no air is present, the liquid will quickly rise in *b*, exerting a noticeable pressure. The pinch-cock *h'* is then closed and the boiling is continued until the 50 c.c. has been re-

duced to a volume of 10 c.c., when the flame is removed and the pinch-cock h'' is immediately closed. The lower end of a , which dips into distilled water, is immediately filled with the latter up to the pinch-cock. The vapors in the flask condense, forming a vacuum, as shown by the closing together of the rubber tubing at h' and h'' .

30 c.c. of the ferrous chloride solution are poured into a beaker and the upper level is marked on the outside with a colored pencil, then 20 c.c. more are added and the position in the beaker is again marked. The lower end of the tube a is placed in the ferrous chloride solution so that it reaches below the lower mark on the beaker, and, by opening h'' , 20 c.c. of the solution are allowed to pass into the flask K . The beaker containing the ferrous chloride is then replaced by one containing boiled water. The tube a should not extend vertically into the water, but should be inclined as much as possible. The specifically heavier ferrous chloride solution in the tube passes into the water, while the latter takes its place. When the lower end of a has become filled with pure water in this way, it is dipped into a beaker containing hydrochloric acid (sp. gr. 1.1) and about 20 c.c. of the acid are allowed to flow into K , and finally 3–4 c.c. of water are added to replace the acid in a . A 50-c.c. measuring-cylinder is now filled with boiled water, placed over the lower end of b as shown in the figure, and the contents of the flask K are heated fifteen minutes on the water-bath,* then heated to boiling with a free flame. As soon as the compressed rubber tubing begins to expand h' is opened, but the rubber tubing is at the same time pinched between the thumb and finger. As soon as the liquid no longer rises in b , the hand is removed from the rubber tubing and the nitric oxide begins to collect slowly in the measuring-tube. After half of the liquid has evaporated there is no further evolution of nitric oxide to be noticed, although the brown color of the solution shows that the gas has not been completely expelled. In order to accomplish this, the flame is removed, h' is closed, and the liquid in K allowed to cool. By means of the vacuum thus produced the remainder of the nitric oxide is expelled from the solution and the boiling is once more repeated, with the same precautions as before, until the lower mark is

* The heating on the water-bath is necessary, as otherwise a little nitric will distil over and not be reduced. A. Wegelin, Inaug. Dissert. Zürich, 1907.

reached. The flame is removed, h' is closed, and the measuring-tube containing the nitric oxide is placed in a cylinder containing pure water at the temperature of the room. To prevent the tube containing the gas from sinking, its upper end is encased in a large cork so that it floats on the water. After standing fifteen to twenty minutes the tube is raised by means of the cork until the level of the liquid within stands at the same height as that in the cylinder without, and the volume of the gas is read. At the same time the temperature of the water is taken and the barometer reading is noted.

The volume thus obtained is reduced to 0° C. and 760 mm. pressure. If the temperature was t° , the barometer reading B millimeters, and w the tension of aqueous vapor at t° , then the reduced volume is

$$V_0 = \frac{V(B-w)273}{760(273+t)} *$$

Now 50 c.c. of the standard potassium nitrate solution contain 0.1011 gm. of KNO_3 corresponding to 0.06201 gm. of NO_3 , so that the volume V_0 of the nitric oxide corresponds to 0.06201 gm. NO_3 .

The same procedure is now followed with 50 c.c. of the solution of the unknown nitrate, which should be prepared so that the amount of nitric oxide evolved will be about the same as that from 50 c.c. of the standard solution. If at t'° C. and B_1 mm. pressure the volume V' of nitric oxide is obtained, and w_1 is the tension of aqueous vapor at t'° , then the reduced volume of the nitrogen will be as before

$$V'_0 = \frac{V'(B_1-w_1)273}{760(273+t'^\circ)}$$

The following proportion now holds:

$$V_0 : 0.06201 = V'_0 : x$$

$$x = \frac{V'_0 \cdot 0.06201}{V_0} = \text{gm. NO}_3 \text{ in 50 c.c. of solution.}$$

* Three or four experiments are performed with the standard solution, and the mean value is used.

Remark.—It is not permissible to compute directly the weight of NO_3 which corresponds to the volume of nitric oxide obtained, for some nitric oxide always remains in the flask, so that low values would result. This error is eliminated by the above procedure.

L. L. de Koninck * has devised an apparatus which prevents the liquid from sucking back into the decomposition-flask and at the same time permits the carrying out of a number of determinations one after the other without cleaning the apparatus or boiling it free from air in the meantime.

Determination of Nitric Acid in a Drinking-water.

From 100 to 300 c.c. of the water are evaporated to 40–50 c.c. in a porcelain dish, a few drops of methyl orange are added, followed by dilute hydrochloric acid, free from nitrate, until the solution is pink in color. Sodium carbonate solution is now added until the liquid is barely alkaline (it becomes yellow) and the contents of the flask are washed into the decomposition-flask *K*, Fig. 79, and analyzed as described on page 457 with the difference that, instead of collecting the gas over water, a 10 per cent. solution of sodium hydroxide is used, to make sure that the carbonic acid which is set free is completely absorbed.

After the experiment has been performed with the water to be analyzed, it is repeated with an amount of the standard solution sufficient to evolve about the same quantity of nitric oxide. The analysis is then computed as before.

Remark.—In drinking-water the neutralization of the evaporated sample is not absolutely necessary, except in the case of alkaline mineral waters; in that case the introduction of the hydrochloric acid would otherwise cause such a violent evolution of carbon dioxide that the flask might crack.

CHLORIC ACID, HClO_3 . Mol. Wt. 84.47.

Forms: Silver Chloride, AgCl , besides volumetric and gasometric methods.

In order to determine chloric acid as silver chloride it must previously be reduced to chloride by means of ferrous sulphate or zinc.

* *Z. anal. Chem.*, **33**, 200 (1894). See also Liechti and Ritter, *ibid.*, **42** 205, (1903).

Reduction by means of Ferrous Sulphate.

About 0.3 gm. of the salt is dissolved in 100 c.c. of water, treated with 50 c.c. of a 10 per cent. solution of crystallized ferrous sulphate, heated with constant stirring till it begins to boil, and kept at this temperature for fifteen minutes. After cooling, nitric acid is added until the deposited basic ferric salt is dissolved, when the chloride is precipitated by means of silver nitrate and weighed after the usual treatment.

One gram of silver chloride corresponds to 0.8550 gm. KClO_3 .

Reduction with Zinc.

Although chlorates are reduced in neutral solution by means of zinc or Devarda's alloy, it is not advisable to effect the reduction in this way for quantitative purposes. The same end is reached more expeditiously by adding zinc-dust to the acetic acid solution. The dilute chlorate solution is treated with acetic acid until it reacts distinctly acid, an excess of powdered zinc is added, and the solution boiled for one hour. After cooling, nitric acid is added in sufficient quantity to dissolve all of the excess of zinc, after which the solution is filtered if necessary and the chloride precipitated and determined as silver chloride.

Remark.—Both methods afford exact results, but the former is to be preferred, for it is accomplished in less time.

Chlorates are not quantitatively decomposed into chlorides by ignition in open vessels or in a current of carbon dioxide. Some chlorine and a little alkali is always lost, so that even when the residue is evaporated with hydrochloric acid, too low results are obtained. L. Blangey, working in the author's laboratory, obtained results which were from 0.3 to 1.1 per cent. below the theoretical value.

According to the two following methods, the decomposition of alkali chlorate into chloride is quantitative.

(a) *By Evaporation with Hydrochloric Acid.*

The chlorate contained in a weighed porcelain crucible is covered with hydrochloric acid (1:3). A watch-glass is placed upon the crucible, and the contents of the latter are heated on the water-

bath until the evolution of chlorine ceases. The liquid on the lower surface of the watch-glass is then washed into the crucible, and its contents are evaporated to dryness on the water-bath. The cover is placed upon it and it is then gently ignited over a free flame until the decrepitation ceases. After cooling in a desiccator, the crucible is again weighed. In this way L. Blangey obtained, as a mean of four experiments, 100.02 per cent. of the theoretical value.

(b) *By Ignition with Ammonium Chloride.*

The alkali chlorate is mixed in a porcelain crucible with three times as much pure ammonium chloride, covered with a watch-glass, and heated over a free flame, kept in constant motion, until the ammonium chloride is completely removed. The crucible is then weighed. As a mean of two experiments, L. Blangey obtained 100.06 per cent. of the theoretical value.

PERCHLORIC ACID, HClO_4 . Mol. Wt. 100.47.

Form: Silver Chloride, AgCl .

Perchlorates cannot be reduced to chloride by means of ferrous sulphate, zinc, or by repeated evaporation with concentrated hydrochloric acid.* On ignition, some chlorine and alkali chloride are lost, so that an error amounting to as much as 1 per cent. may be expected. On the other hand, Winteler has shown that perchlorates may be changed to chlorides by heating with concentrated nitric acid and silver nitrate in a closed tube (see Carius' method for determining chlorine in organic substances, page 325), while L. Blangey found that ignition with ammonium chloride would accomplish the same result.

Decomposition of Perchlorates by Ignition with Ammonium Chloride.

By twice igniting an intimate mixture of 0.5 gm. potassium perchlorate with $1\frac{1}{2}$ to 2 gms. of ammonium chloride † in a *platinum*

* On evaporating with hydrochloric acid there is a loss without any evolution of chlorine; it must be due to the volatilization of small amounts of perchloric acid.

† When 2 gms. of NH_4Cl are used, one and one-half to two hours are necessary.

crucible covered with a watch-glass, the former is completely changed to chloride. Care should be taken not to melt the residual chloride, for in that case the platinum is attacked, although the accuracy of the results is not affected. Blangey obtained in two experiments 100.06 and 100.08 per cent. of the theoretical values.

It is worth mentioning that complete decomposition could not be effected by igniting three times in a *porcelain** crucible; the platinum evidently plays the part of a catalyser, as was proved by the following experiment: 0.4767 gm. of KClO_4 was mixed in a porcelain crucible with $1\frac{1}{2}$ gm. of NH_4Cl , and 1 c.c. of hydrochloroplatinic acid (containing 0.0918 gm. Pt) was added. After evaporating to dryness on the water-bath, the ammonium chloride was completely expelled and the residue was ignited twice more with the same amount of the latter. The residue of potassium chloride then weighed 0.2572 gm., corresponding to 100.24 per cent. of the theoretical amount.†

Determination of Perchloric Together with Chloric Acid.

In one portion the chlorate is reduced, as described on page 461, with ferrous sulphate, and the chloride formed determined as silver chloride. A second portion is ignited in an old platinum crucible (or in one of porcelain) with the addition of 1 c.c. of hydrochloroplatinic acid and three times as much ammonium chloride (as described above). In this way the total amount of chlorine is obtained and from these data the amount of each acid can be calculated.

Determination of Perchloric, Chloric, and Hydrochloric Acids in the Presence of One Another.

The three acids are assumed to be present in the form of their alkali salts.

* Thus on igniting 0.4395 gm. KClO_4 with 2 gms. NH_4Cl a residue of 0.3205 gm. was obtained instead of one weighing 0.2365 gm.

† There is often a slight deposit of alkali chloride upon the cover-glass. To determine this, the glass together with the deposit is weighed, then the glass is washed, dried, and again weighed; the difference between the two weights represents the amount of alkali chloride. This rarely amounts to more than a fraction of a milligram, and if the ignition was performed with care, there will be no deposit at all upon the glass.

In one portion the chloride-chlorine is determined by precipitation with silver nitrate. In a second sample the chlorate and chloride-chlorine are determined after the former has been reduced to chloride by means of ferrous sulphate. The total amount of chlorine present is determined in a third portion after ignition with ammonium chloride.

GROUP VI.

SULPHURIC, HYDROFLUORIC, AND HYDROFLUOSILICIC ACIDS.

SULPHURIC ACID, H_2SO_4 . Mol. Wt. 98.09.

Form: Barium Sulphate, $BaSO_4$.

Theoretically the gravimetric determination of sulphuric acid is extremely simple, it being only necessary to precipitate with barium chloride, filter and weigh the barium sulphate. Practically, however, it is a process connected with many difficulties.

According to the manner of precipitating barium sulphate, the composition of the precipitate varies in such a way that sometimes the results are too high and sometimes too low.

Errors which may Occur in the Precipitation of Barium Sulphate.*

I. In the Precipitation of Barium Chloride with Pure Sulphuric Acid.

If a dilute, slightly acid solution of barium chloride is treated at the boiling temperature with an excess of dilute sulphuric acid, the precipitate contains all of the barium except a very small, negligible amount. If, however, the precipitate is weighed, the result is invariably too low; and this is true even when the solution is evaporated to dryness in order to recover the last traces of barium. The precipitate always contains barium chloride in a form which cannot be removed by washing. A mixture, therefore, of barium sulphate and barium chloride is weighed, and as the molecular weight of the latter is less than that of the former, the result must be too low. In order to obtain accurate results the chlorine combined with barium in the precipitate must be replaced

* See the interesting article by M. J. van't Kruijs on the determination of sulphuric acid in the presence of various salts which affect the result. *Z. anal. Chem.*, 1910, 393.

by SO_4 ; and this is easily accomplished by moistening the precipitate with concentrated sulphuric acid, and heating until the excess of the latter is removed by volatilization.

Not only is barium *chloride* carried down with barium sulphate, but all barium salts as well, especially the chlorate and nitrate. These are, however, readily changed to sulphate by the above treatment with concentrated sulphuric acid. It is immaterial in the estimation of barium how the precipitation is effected; whether the sulphuric acid is added quickly, or drop by drop, the results are always the same.

II. In the Precipitation of Pure Sulphuric acid with Barium Chloride.

This is the reverse process, but in this case it is not a matter of indifference whether the barium chloride is added slowly, drop by drop, or rapidly all at one time. In the first instance, the results are very near the truth without applying any correction whatsoever; in the latter instance, too high results are obtained, because by the rapid addition of the reagent much more barium chloride is carried down with the precipitate than when the reagent is added very slowly.

To obtain the true weight of barium sulphate, it is often necessary to make a deduction for the amount of barium chloride contained in the precipitate and to add the weight of barium sulphate remaining in solution.

The chlorine contained in the precipitate can be determined in several different ways.

1. The precipitate is fused with four times as much pure sodium carbonate, the melt extracted with hot water, the solution filtered, acidified with nitric acid, and the chlorine precipitated with silver nitrate which is filtered off and weighed. (Cf. p. 320.)

2. Still more accurate is the process of Hulett and Duschack * The greater part of the ignited precipitate of barium sulphate is placed in a U-tube of which one arm is drawn out into a thin, right-angled, gas delivery tube. Concentrated sulphuric acid is added to the precipitate and the mixture is heated by placing the U-tube in hot water. The barium sulphate dissolves readily in

* Z. anorg. Chem., 40, 196 (1904).

the hot concentrated sulphuric acid and the barium chloride present is decomposed. In order to determine the amount of hydrochloric acid set free, a slow stream of air, which has previously passed through caustic potash solution, is led through the tube, which has the drawn-out end of the latter dipping into a stout test-tube containing 0.01 N. silver nitrate solution. After two or two and one-half hours all of the hydrochloric acid will have been expelled from the sulphuric acid.

The decomposition apparatus is then removed, the gas delivery tube washed out with a little water, and the silver remaining in solution is determined volumetrically (cf. pp. 702-05).

For the determination of the dissolved barium sulphate the filtrate from the first precipitation is evaporated to dryness,* the residue moistened with a few drops of concentrated hydrochloric acid, taken up with water and the slight precipitate of barium sulphate filtered off and weighed.

Calculation of the true weight of Barium Sulphate.—If the weight of the first precipitate of crude barium sulphate is a , the weight of the barium chloride contained in this precipitate, as determined by titration of the amount of chlorine, is b , and the amount of barium sulphate in solution is c , then $a - b + c$ represents the weight of pure barium sulphate.

Experience has shown, however, that when pure sulphuric acid is precipitated by means of dilute barium chloride solution added drop by drop, the errors b and c are approximately equal and counterbalance one another so that the weight a is very close to that of the pure barium sulphate.

III. In the Precipitation of Sulphates with Barium Chloride.

Here the relations are far more complicated than in the precipitation of pure sulphuric acid, partly because the barium sulphate is much more soluble in salt solutions than in water containing a little acid, and partly because of the tendency of barium sulphate to occlude not only barium chloride but many other salts as well. Solutions of chromium sulphate are either

* During all such work care should be taken to prevent sulphuric acid contamination from the air in the laboratory. The evaporation should therefore take place on the steam bath or steam table.

violet or green. From the boiling-hot green solution only one-third of the sulphuric acid is precipitated, the remainder probably being present in the form of a complex chromium sulphate cation; * on cooling there is a tendency for the green solution to become violet and after some time all of the sulphuric acid is precipitated. The precipitation of barium sulphate in the presence of ferric iron has been much studied. In the boiling hot solution all of the sulphuric acid is not precipitated and considerable iron is thrown down with the barium sulphate and furthermore the precipitate then loses SO_3 on ignition. Since ferric oxide weighs much less than an equivalent weight of barium sulphate sometimes the results are as much as 10 per cent. too low. On the other hand, Küster and Thiel, † were able to get satisfactory results (1) by precipitating the sulphuric acid from such a solution in the cold, or (2) by slowly adding the ferric chloride and sulphuric acid solution to the hot solution of barium chloride, or (3) by precipitating the iron by an excess of ammonia, heating, and adding barium chloride to the solution without filtering off the ferric hydroxide, and finally dissolving the latter in dilute hydrochloric acid.

Most chemists, however, deem it advisable to remove trivalent metals before attempting to determine the sulphuric acid. This is accomplished in the case of ferric iron by adding a liberal excess of ammonia to the dilute slightly acid solution which is at a temperature of about 70° . If from 5–7 c.c. of concentrated ammonia (sp. gr. 0.90) is added in excess of the amount required for neutralization, ‡ the precipitate is not likely to contain any basic ferric sulphate. If, on the other hand, the solution is barely neutralized with ammonia, the precipitate produced will invariably contain some sulphate.

The bivalent metals are occluded to a much less extent, so that it is not, as a rule, necessary to remove them. On the other hand, in the presence of considerable amounts of bivalent metal with relatively small amounts of sulphuric acid, the error arising from occlusion is likely to be large, so that it is better to remove the bivalent metals in all such cases.

* Recoura, *Comptes rendus*, **113**, 857; **114**, 477.

† *Z. anorg. Chem.*, **22**, 424.

‡ Pattinson, *J. Soc. Chem. Ind.*, **24**, 7.

In the presence of nitric or chloric acid the barium sulphate precipitate will contain considerable quantities of barium chlorate and nitrate which it is impossible to remove by washing with hot water. These acids, therefore, must be decomposed by evaporation with hydrochloric acid before attempting to precipitate the sulphuric acid.

In ordinary chemical practice it is usually a question of determining sulphuric acid in a solution containing considerable amounts of ammonium or alkali chloride, ammonium or alkali sulphate, and some free hydrochloric acid. Now ammonium and alkali sulphates are also occluded by barium sulphate, and the amount of occlusion increases as the solution is more concentrated with respect to these substances. For this reason it is evident that barium sulphate should always be precipitated in a very dilute solution. Furthermore, a small amount of free hydrochloric acid is indispensable, but larger amounts have a solvent effect upon the precipitate.

For an amount of sulphuric acid corresponding to between 1 and 2 gms. of barium sulphate, the precipitation should take place in a volume of between 350 and 400 c.c. and in the presence of hydrochloric acid amounting to 1 c.c. of sp. gr. 1.17.

If a *neutral* solution is at hand, it is diluted to a volume of 350 c.c. and 1 c.c. of concentrated hydrochloric acid is added.

An *alkaline* solution is carefully neutralized with hydrochloric acid, using methyl orange as indicator, 1 c.c. of concentrated hydrochloric acid is added in excess, and the solution is diluted to 350 c.c.

Finally, in the case of an *acid* solution, it is either evaporated to dryness, the residue moistened with 1 c.c. of concentrated hydrochloric acid and 350 c.c. of water added, or, with methyl orange as indicator, the solution is neutralized with ammonia, treated with 1 c.c. of concentrated hydrochloric acid, and diluted to 350 c.c.

After the solution has been prepared in accordance with the above directions it is ready for the

Precipitation of Sulphuric Acid in the Presence of Ammonium or Alkali Salts according to E. Hintz and H. Weber.

The solution is heated to boiling, and then for each gram of barium sulphate precipitate 10 c.c. of normal barium chloride solution are taken, diluted to 100 c.c., the solution heated to boiling, and added all at one time to the hot sulphate solution which is being stirred continuously. After the solution has stood for half an hour, best in a warm place, it is filtered, washed with hot water and ignited (cf. p. 74). The use of a Gooch or Munroe crucible is to be recommended.

Remarks.—In the presence of ammonium salts the precipitation of the barium sulphate should not be effected, as is otherwise desirable, by the cautious addition of the barium chloride, for, as Hintz and Weber have shown, this leads to low results whereas the occlusion caused by the rapid addition of the barium chloride counterbalances this error.

Under no circumstances should a precipitate of barium sulphate be heated over a blast lamp, for in that case sulphuric anhydride would be evolved from the barium sulphate itself.

To explain the occlusion of barium chloride by barium sulphate, Hulett and Duschak * have suggested that perhaps the precipitate may contain salts such as $\text{BaCl} \cdot \text{HSO}_4$, $(\text{BaCl})_2\text{SO}_4$, and $\text{Ba}(\text{HSO}_4)_2$ and Folin † believes that such is this case because some of his precipitates have lost SO_3 on ignition while others have lost HCl . He also suggests the possibility of salts such as $\text{Ba}(\text{KSO}_4)_2$ being precipitated.

Determination of Sulphuric Acid in Insoluble Sulphates

Calcium and strontium sulphates are decomposed by long digestion with ammonium carbonate solution, but barium sulphate is not. The latter is mixed with four times as much sodium carbonate, fused in a platinum crucible, the melt extracted with water, and the barium carbonate residue washed with sodium carbonate solution. After acidifying the filtrate with hydro-

* Z. Anorg. Chem., **40**, 196 (1904).

† J. Biol. Chem., **1**, 131 (1905).

chloric acid and boiling off the carbon dioxide, the sulphuric acid is precipitated as usual.

Lead sulphate is boiled with sodium carbonate solution; after cooling, the solution is saturated with carbon dioxide and filtered. The lead remains behind as carbonate, while the filtrate contains all of the sulphuric acid.

For the determination of sulphuric acid in silicates, the finely powdered substance is fused with six times as much sodium carbonate, the melt is extracted with water, the filtrate acidified with hydrochloric acid and evaporated to dryness in order to dehydrate the silica. The residue is moistened with a little concentrated hydrochloric acid, taken up in hot water, and the silicic acid filtered off; the sulphuric acid is determined in this filtrate.

Determination of Sulphuric Acid in the Presence of Soluble Sulphides.

The substance is placed in a flask, the air replaced by carbon dioxide, dilute hydrochloric acid is added, and the solution boiled while carbon dioxide is passed through it until all of the sulphide has been expelled. The sulphuric acid is then precipitated from the solution.

This determination is used for the analysis of cements. In this case, however, the hydrochloric acid solution will contain much calcium as well as iron and aluminium, so that these metals are precipitated by the addition of ammonia and ammonium carbonate and the sulphuric acid determined in the filtrate.

If it is desired to determine the amount of sulphide-sulphur, the substance is covered with bromine water until the color of the bromine is permanent, hydrochloric acid is added, and the solution boiled to expel the excess of the bromine. The iron, aluminium, and calcium are precipitated by ammonia and ammonium carbonate, and the total sulphur is determined in the filtrate. The difference between the two results represents the amount of sulphur present as sulphide. For the volumetric determination of sulphuric acid consult Part II.

HYDROFLUORIC ACID, HF. Mol. Wt. 20.01.

Forms: Calcium Fluoride, CaF_2 ; Silicon Fluoride, SiF_4 , besides volumetric and gasometric methods.

i. Determination as Calcium Fluoride.

If the solution contains free hydrofluoric acid or an acid fluoride, sodium carbonate is added until the reaction is alkaline and from one-fourth to one-fifth as much more in excess.* To solutions of neutral fluorides about 1 c.c. of double-normal sodium carbonate solution is added. The alkaline solution is heated to boiling, precipitated by means of an excess of calcium chloride solution, filtered, and thoroughly washed with hot water. The precipitate consisting of the fluoride and carbonate of calcium is dried, as much of it as possible is transferred to a platinum crucible, the ash of the filter is added, and the contents of the crucible are ignited.† After cooling, the mass is covered with an excess of dilute acetic acid, by which the lime is changed to the soluble acetate, while the fluoride is unaffected. The mixture is evaporated to dryness on the water-bath, the residue is moistened with water and a few drops of 6-normal acetic acid, and the insoluble calcium fluoride is filtered off, washed, and dried.‡ After transferring as much of the dried CaF_2 to the crucible as possible, the filter-paper is burned, its ash added, and after ignition the crucible is again weighed. To confirm the result the substance is treated with a little concentrated sulphuric acid (added cautiously), and after evaporating off the excess of the latter and once more igniting, the contents of the crucible are weighed as calcium sulphate.

1 gm. CaF_2 yields 1.7436 gms. CaSO_4 .

Remark.—The results are usually a little low on account of the solubility of calcium fluoride; 100 c.c. water dissolves 0.0016 gm., and 100 c.c. 1.5 N. acetic acid dissolves 0.011 gm. CaF_2 at the temperature of the water bath.

* By the addition of the excess of sodium carbonate the precipitate of calcium fluoride will contain calcium carbonate, and presence of the latter renders the precipitate easy to filter. A pure precipitate of calcium fluoride is so slimy that the pores of the filter become so clogged that it is almost impossible to complete the filtration.

† The ignition makes the CaF_2 denser and hence easier to filter.

‡ The calcium fluoride is not volatilized in an open platinum crucible heated over a Bunsen burner. Heated over the blast, there is appreciable volatilization.

Example: Determination of Fluorine in Calcium Fluoride.—As was stated in Vol. I, CaF_2 is not completely decomposed by fusing with sodium carbonate; but if the fluoride is mixed with $2\frac{1}{2}$ times as much silicic acid and then fused with 6 times as much sodium-potassium carbonate, the greater part of the silicic acid and all of the fluorine will be changed to soluble alkali salts, while the calcium will be left as insoluble calcium carbonate. The mixture must be heated gradually (best in a platinum dish), as otherwise the evolution of carbon dioxide may cause the melt to boil over. The thin liquid fusion soon changes to a thick paste or only sinters somewhat. On raising the temperature, it is almost impossible to further melt this mass, and it is not necessary. In fact too high a temperature is to be avoided on account of the danger of losing some alkali fluoride by volatilization. The reaction is complete when there is no further evolution of carbon dioxide. After cooling, the melt is treated with water, the insoluble residue is filtered off and thoroughly washed. The alkaline solution containing all the fluorine and considerable silicic acid is freed from the latter by the addition of considerable ammonium carbonate* (about 4 gms. of the solid salt). The liquid is heated for some time at about 40°C ., allowed to stand overnight, and in the morning the voluminous precipitate is filtered off and washed with ammonium carbonate water (pure water will give a turbid filtrate). The filtrate now contains only a small amount of silicic acid. It is evaporated almost to dryness on the water-bath,† diluted with a little water and a few drops of phenolphthalein are added. The liquid is colored pink by the indicator and enough hydrochloric acid is now added to make it colorless. The solution is heated to boiling, and this causes the reappearance of the pink color. After cooling the color is again discharged with hydrochloric acid, and this operation is repeated until finally the addition of $1-1\frac{1}{2}$ c.c. of double-normal hydrochloric acid is sufficient to effect the decolorization.

* Before adding the ammonium carbonate, the greater part of the alkali carbonate should be neutralized with dilute hydrochloric acid, but care should be taken not to make the solution acid.

† The liquid foams during the evaporation owing to the decomposition of the excess of ammonium carbonate; the evaporating-dish is covered with a watch-glass until the evolution of carbon dioxide ceases.

It is best to perform the operation in a platinum dish, but if this is lacking one of porcelain may be used.

The solution still contains traces of silicic acid, which are removed, as recommended by Berzelius, as follows: The solution is treated with 1 or 2 c.c. of ammoniacal zinc oxide solution,* boiled until the ammonia is completely expelled and the precipitate of zinc silicate and oxide is filtered and washed with water. An excess of calcium chloride is added to the filtrate and the resulting precipitate, consisting of calcium carbonate and fluoride, is treated as described on page 471.

The calcium fluoride finally obtained should be tested for fluorine, for the addition of calcium chloride will almost always cause a precipitation (cf. page 471), which may consist of calcium fluoride and phosphate, or the latter only. After weighing the precipitate, it is treated with a few drops of concentrated sulphuric acid and covered with a watch-glass whose convex surface is coated with a thin layer of beeswax with a few lines scratched in the latter. The crucible is allowed to stand this way for twelve hours at the ordinary temperature. A little water is then poured upon the watch-glass and the crucible is heated over a tiny flame until the vapors of sulphuric acid begin to be evolved. If fluorine is present there will be a distinct etching of the glass where the wax coating was removed.

The weight of the calcium fluoride obtained should stand in the same relation to that of calcium sulphate obtained after treatment with concentrated sulphuric acid, as



This relation does not hold exactly in practice, for it is almost impossible to obtain a precipitate of calcium fluoride absolutely free from silica.

Remark.—By this method the fluorine present in all fluorides can be determined, e.g., in topaz, lepidolite, cryolite, etc. With a silicate containing much silica, the addition of silicic acid is

* Moist zinc oxide is dissolved in ammonia water. The oxide is best prepared by dissolving chemically pure zinc in hydrochloric acid, and precipitating the zinc with potassium hydroxide; the precipitate is filtered and washed.

unnecessary, and the substance is at once fused with 4-5 times as much sodium-potassium carbonate; with silicates containing little silica, from $\frac{1}{2}$ -1 part of silicic acid is added.

If the substance contains phosphoric acid, the fluorine cannot be determined by the above method, because the calcium fluoride precipitate is then contaminated with calcium phosphate. It is then necessary to effect a

Separation of Phosphoric and Hydrofluoric Acids.

The following method is that of Rose as modified by the author and A. A. Koch.* It is based upon the fact that silver phosphate is insoluble in water whereas silver fluoride is soluble.

Procedure.—The alkaline solution of the two acids † is carefully neutralized with nitric acid and then transferred to a 250 c.c. calibrated flask. A slight excess of silver nitrate is added, the solution diluted to the mark, thoroughly mixed and the precipitate allowed to settle completely. The solution is then filtered through a dry filter, but the first 10 c.c. of the filtrate are rejected, and the rest allowed to run into a dry flask. Of this filtrate, exactly 200 c.c. are transferred to a 250-c.c. flask again, the excess of the silver nitrate precipitated by the addition of some dissolved sodium chloride, the solution made up to the mark, well shaken and the precipitate allowed to settle completely. This solution is filtered, using the same precautions as before, and the fluorine is determined in 200 c.c. of the filtrate as calcium fluoride according to the directions on p. 471.

If the weight of the calcium fluoride precipitate is p , that of the original substance is a , and x is the per cent. of fluorine originally present, then allowing for the fact that only 64 per cent. of the original sample was used for the final precipitation,

$$\frac{76.05p}{a} = \text{per cent. } F.$$

* *Z. anal. Chem.*, **43**, 439 (1904).

† It is usually a matter of analyzing an aqueous solution of a sodium carbonate fusion. In the analysis of rocks, the procedure described on page 472 should be followed until the silicic acid is removed by treatment with ammonium carbonate.

Determination as Silicon Fluoride.

This method, proposed by Fresenius, depends upon the fact that many fluorides are decomposed by the action of concentrated sulphuric acid and silica, while the fluorine escapes as silicon fluoride, which can be absorbed and weighed.

Procedure.—The same reagents and a very similar apparatus to that described on p. 477 is required for this determination, except that in place of the Péligot tubes (Fig. 80) two weighed U-tubes are used,* of which the first is filled with moistened pieces of pumice, and the second has one arm filled with soda lime and the other with calcium chloride. The analysis is carried out in exactly the same way as is described for the Penfield method (see below) but at the end of the experiment the two U-tubes are weighed. The increase in weight represents the amount of SiF_4 , and from this the amount of fluorine present is calculated as follows: Assume that a gms. of calcium fluoride yielded p gms. of SiF_4 . The treatment with the concentrated sulphuric acid caused the following reaction to take place:

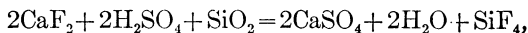

consequently the following proportion holds:

$$\text{SiF}_4 : 4\text{F} = p : s$$

$$s = \frac{4\text{F}}{\text{SiF}_4} \cdot p = \text{gms. fluorine}$$

and in per cent.

$$a : \frac{4\text{F}}{\text{SiF}_4} \cdot p = 100 : x$$

$$x = \frac{400\text{F}}{\text{SiF}_4} \cdot \frac{p}{a}$$

or

$$x = 72.87 \cdot \frac{p}{a} = \text{per cent. fluorine.}$$

* It is best to use U-tubes for the absorption which are provided with ground-glass stoppers (see Fig. 59, p. 381).

Remark.—This method is suitable for the determination of fluorine in all fluorides which are decomposed by sulphuric acid. The analysis can be carried out in the presence of phosphates, but if carbonates are present they should be decomposed by ignition before the treatment with sulphuric acid. According to K. Daniel,* exact results are obtained only when the decomposition of the fluoride takes place at the temperature at which sulphuric acid boils.

For the determination of fluorine in topaz and micas, the method is not suitable.

Determination of Fluorine as Hydrofluosilicic Acid, according to S. L. Penfield.†

Modified by Treadwell and Koch.‡

Principle.—Penfield expels the fluorine as silicon fluoride in exactly the same way as in the method of Fresenius (page 475), but the gas is absorbed in 50 per cent. alcoholic potassium chloride solution. By contact with water the silicon fluoride is decomposed into hydrofluosilicic and silicic acids. The former unites with the potassium chloride, forming potassium silicofluoride, insoluble in 50 per cent. alcohol:

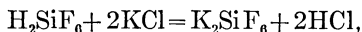

and sets free an equivalent amount of hydrochloric acid; the latter is titrated with N/5 sodium hydroxide solution, with cochineal is an indicator. For the calculation the following proportion holds:

$$1000 \text{ c.c. N/5 HCl} = \frac{3}{10} \text{ mol. CaF}_2 = \frac{3}{8} \text{ F.}$$

$$\therefore 1 \text{ c.c. N/5 NaOH} = 0.0234 \text{ gm. CaF}_2 \text{ or } 0.0114 \text{ gm. F.}$$

*Z. anorg. Chem., **38**, 257 (1904).

†Chem. News, **39**, p. 179; also Am. Chem. Jour., **1**, p. 27.

‡Z. anal. Chem., **43**, 469 (1904).

Requirements.—1. *Pure Quartz Powder.* Pieces of pure rock crystal are placed in a platinum crucible, heated strongly over the blast lamp, and then thrown into cold water. After this treatment it is very easy to reduce the quartz to a fine powder by grinding in an agate mortar. The powder is ignited, and while still warm is transferred to a flask, fitted with ground-glass stopper. The open flask and its contents are allowed to cool in a desiccator, after which the flask is stoppered and set aside.

2. *Sea Sand.* The purest sea sand is treated with boiling, concentrated sulphuric acid, washed, dried, ignited, and cooled in a desiccator.

3. *Anhydrous Sulphuric Acid.* Chemically pure concentrated sulphuric acid is heated in a porcelain crucible until it has fumed strongly for some time and then allowed to cool in a desiccator over phosphorus pentoxide.

Procedure.—The weighed sample of the fluoride is intimately mixed in an agate mortar, which is placed upon black glazed paper, with 1.5–2 gms. of the quartz powder and then transferred through the cylindrical arm *A* of the perfectly dry decomposition apparatus to the pear-shaped compartment *B* shown in Fig. 80. Then 1.5–2 gms. of the sea sand are added, and mixed with the rest of the material by shaking the apparatus, which is then connected with the dry U-tube containing glass beads. The two Péligré tubes *P* and *P*₁ each contain between 10 and 15 c.c. of alcohol which is saturated with potassium chloride. When the apparatus is all connected as shown in the drawing, a dry current of air, † free from carbon dioxide, is allowed to enter at *h*, and pass through the apparatus at the rate of 2 or 3 bubbles per second. Then without stopping the air current, about 20 c.c. of anhydrous sulphuric acid is allowed to enter the decomposition apparatus through the funnel *T*. By introducing the sulphuric acid in this way, while maintaining the air current, the sulphuric acid and the

* This tube serves to keep back any sulphuric acid that is carried over mechanically.

† The air is passed through caustic potash solution, then over calcium chloride, and finally through concentrated sulphuric acid before entering the apparatus.

greater part of the silica and fluoride mixture is made to pass directly into the compartment *B*. After adding the sulphuric acid, the decomposition vessel is placed in a paraffin bath which is slowly heated to a temperature of 130° to 140° C. The evolution of silicon tetrafluoride at once begins to take place, as is evident from the formation of foam. The passage of the air and heating of the bath is allowed to continue for five hours, at the end of which time the flame under the bath is turned down and air is passed through the apparatus for half an hour longer at the rate

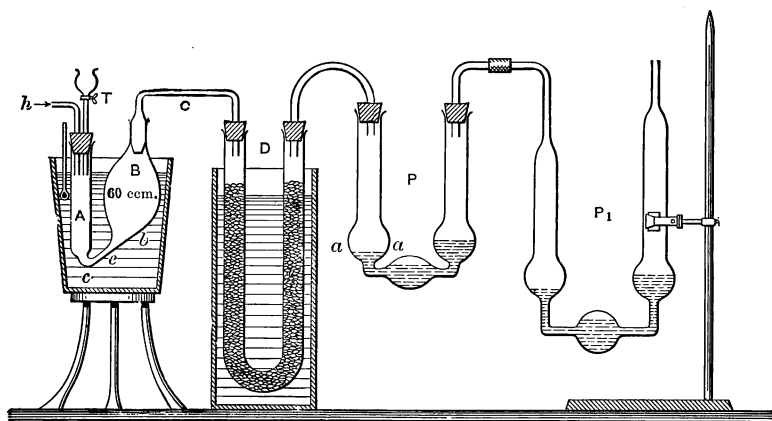

FIG. 80.

of 3 to 4 bubbles per second. During the heating the apparatus should be frequently shaken in order that the sulphuric acid is brought into contact with all portions of the solid mixture. It is not necessary, however, with this arrangement of the apparatus, to shake as frequently as in the forms of apparatus described by Penfield and by Fresenius, because the air in its passage through the narrow connecting tube between *A* and *B* of the decomposition apparatus serves of itself to effect a good mixing. In order to accomplish this end, however, it is necessary to construct the apparatus exactly as shown in Fig. 80; the connecting tube

between *A* and *B* must be so narrow that it is completely filled with the bubbles of air passing, and furthermore the parts marked *c e b* must form an inclined plane upon which the substance can readily pass back and forth. If there is a hollow in the apparatus at *c e b*, in which some of the substance can collect, the sulphuric acid may not come in contact with some of the fluoride so that the decomposition will be incomplete. Similarly it is necessary to guard against making the connecting tube *c e* too narrow, as otherwise the air will not pass in a uniform stream, but in spurts, so that in spite of the long tube *D* some of the sulphuric acid fumes are likely to reach the Péligré tubes and thereby give rise to high results.

If not more than 0.1 gm. of the fluoride was present, the action is over at the end of five and one-half hours, and this is evident, as Daniel* was the first to discover, from the fact that the foaming in the apparatus ceases; the hydrochloric acid which has been set free in the Péligré tubes can now be titrated. To this end a few drops of fresh cochineal† solution are added to each tube and the contents are titrated with fifth-normal potassium hydroxide solution with frequent shaking, until the indicator changes from yellow to red. This is, however, by no means the correct end-point, because as Penfield observed, the gelatinous silicic acid encloses very appreciable amounts of hydrochloric acid. The silicic acid, therefore, must be thoroughly worked over with a stirring rod and the addition of the alkali continued until the color change is permanent.

The results obtained by this method, using 0.1 gm. of substance, appear to be about 0.4 per cent. too high. The method can be used in the presence of phosphoric acid, but carbonates are first removed by ignition before the treatment with sulphuric acid.

* *Z. anorg. Chem.*, **38**, 257 (1904).

† Instead of cochineal, methyl orange may be used, although it is necessary then to add an equal volume of alcohol before titrating the hydrochloric acid.

Determination of Fluorine in Mineral Waters.

From 1 to 10 liters of the water (according to the amount of salts present) are evaporated in a large platinum or porcelain dish to a small volume, with the addition of enough sodium carbonate to keep the solution slightly alkaline. Then an excess of calcium chloride is added, the liquid boiled, and the precipitate filtered and washed with hot water until free from chlorides. The precipitate is dried, transferred as completely as possible to a platinum dish, and the ash of the filter added to the main precipitate which is then gently ignited. This residue contains all of the fluorine as calcium fluoride; besides considerable calcium (possible strontium) and magnesium carbonates; iron, aluminium and manganese oxides; often barium sulphate; and almost invariably some calcium phosphate. It is treated with an excess of dilute acetic acid, allowed to stand for some time with frequent stirring, and then evaporated to dryness on the water bath. This residue is treated with water, filtered, and washed with hot water. As much of it as possible is transferred to a platinum crucible, the ash of the filter added, and the contents of the crucible gently ignited. From $\frac{1}{2}$ –2 gms. of ignited quartz powder are then intimately mixed with the residue in an agate mortar. The mixture is transferred to the decomposition vessel A, Fig. 80, and treated with concentrated sulphuric acid exactly as described on p. 477 by the method of Penfield. As only very little fluorine is present in this case, two small U-tubes are used instead of the large Peligot tubes shown in Fig. 80.

Remark.—The formation of a precipitate in the first U-tube at the place marked *a a* in Fig. 80 indicates the presence of fluorine. It is well to confirm it by the etching-test. After carrying out the titration of the hydrochloric acid set free, the contents of the U-tube are transferred to a platinum dish, a few drops of double normal sodium carbonate added, and the solution evaporated to dryness. Ammoniacal zinc oxide is then added (cf. p. 473), the liquid again removed by evaporation, the residue taken up in water, and the

zinc oxide and silicate filtered off. The filtrate is treated with calcium chloride as described on p. 473 and the etching test applied.

In the former editions of this book it was recommended to determine the fluorine in mineral waters by evaporating a very much larger volume of the water nearly to dryness, filtering, and then examining the insoluble residue alone for fluorine. In this way the fluorine content of many mineral waters was entirely overlooked.

Gas-Volumetric Determination of Fluorine according to Hempel and Oettel.

See Part III, Gas Analysis.

Separation of Fluorine.

(a) From the Metals.

For the determination of the metals present, the fluorine usually can be removed by heating with concentrated sulphuric acid; in the case of many silicates containing fluorine, however, e.g., topaz, lepidolite, and other micas, this treatment will not accomplish the desired result. In such cases the mineral is fused with 4 to 6 times as much sodium-potassium carbonate, the melt is extracted with water, the silica and aluminium precipitated from the solution obtained by means of ammonium carbonate (see page 472), and these two substances determined in the residue, while the filtrate is used for the fluorine analysis. The metals and the remainder of the silicic acid are determined in the residue obtained on extracting the melt with water (cf. p. 493). The estimation of the alkalis must be undertaken in a separate portion of the substance (pp. 497-501).

(b) Separation of Fluorine from the Acids.

1. *Determination of Hydrochloric and Hydrofluoric Acids in the Presence of One Another.*

In the case of soluble alkali salts, the fluorine is first precipitated from the solution by means of a little sodium carbonate and an excess of calcium nitrate solution, as described on p. 471. The filtrate is acidified with nitric acid and the chlorine determined by precipitation with silver nitrate, according to p. 320.

It is simpler to treat the solution containing hydrochloric and hydrofluoric acids in a platinum evaporating dish with nitric acid and silver nitrate. Silver chloride is alone precipitated and can be filtered off, using a funnel of hard rubber, or a glass one coated over with wax. The precipitate is washed and weighed as described on p. 320. When phosphoric acid also is present, this is precipitated with the hydrochloric acid by the addition of silver nitrate to the slightly alkaline solution, the precipitate is filtered off, washed with as little cold water as possible, and the precipitate treated with dilute nitric acid. By this means the silver phosphate goes into solution, while the silver chloride is unaffected. In order to determine the amount of phosphoric acid present, the silver is removed from the solution by the addition of hydrochloric acid, and the phosphoric acid is precipitated in the filtrate by addition of magnesia mixture and ammonia (cf. p. 434).

In the filtrate from the silver phosphate and silver chloride precipitate, the excess of silver nitrate is removed by the addition of sodium chloride and the fluorine is determined as calcium fluoride.

In the case of an insoluble compound containing chlorine and fluorine, the melt obtained after fusing with sodium-potassium carbonate is extracted with water, the silica is removed with ammonium carbonate and zinc-ammonium hydroxide as

described on pp. 472-3, and the chlorine and fluorine determined as above.

In a majority of cases it is more convenient to determine the two acids in separate portions of the substance.

2. Determination of Boric and Hydrofluoric Acids.

The solution containing the alkali salts of these two acids is precipitated at the boiling temperature by means of an excess of calcium chloride; the precipitate is filtered off and washed with hot water.

The precipitate, consisting of calcium carbonate, calcium fluoride, and some calcium borate, is gently ignited, treated with dilute acetic acid, evaporated to dryness, and more acetic acid and water are added. By this means the calcium acetate and calcium borate go into solution, while the calcium fluoride is left behind and is determined as described on p. 471. For the boric acid determination a second portion of the solution is taken, made barely acid with acetic acid, and treated with a slight excess of calcium acetate solution in order to precipitate the fluorine. The solution, together with the calcium fluoride, is placed in the Gooch retort and subjected to distillation as described on p. 428.

HYDROFLUOSILICIC ACID, H_2SiF_6 . Mol. Wt. 144.32.

Forms: Calcium Fluoride, CaF_2 ; Potassium Silicofluoride;
or volumetrically.

1. Determination as Calcium Fluoride.

Principle.—Alkali fluosilicates are decomposed on heating with sodium carbonate solution into fluoride and silicic acid:

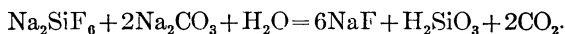

If a solution is to be analyzed containing free hydrofluosilicic acid or its sodium salt, it is treated with sodium carbonate solu-

tion until the reaction is alkaline, a considerable amount of ammonium carbonate is added, the solution heated to about 40° C., and, after standing twelve hours, the precipitated silicic acid is filtered off.

The solution now contains all the fluorine as sodium fluoride, in the presence of small amounts of silicic acid, which are precipitated by the addition of zinc-ammonia hydroxide (see p. 473). In the filtrate the fluorine is determined as calcium fluoride, as described on p. 471.

An insoluble fluosilicate is fused with four times as much sodium-potassium carbonate, the melt extracted with water, and the solution subjected to the above treatment.

2. Determination as Potassium Silicofluoride.

This analysis is only applicable for the determination of free hydrofluosilicic acid in aqueous solution.

Procedure.—The solution is treated with potassium chloride and an equal volume of absolute alcohol. The barely-visible potassium silicofluoride is filtered through a tared filter which has been dried at 100° C. After washing with 50 per cent. alcohol the precipitate is dried at 100° C. and weighed as K_2SiF_6 .

The volumetric determination of hydrofluosilicic acid will be discussed in Part II.

Analysis of Salts of Hydrofluosilicic Acid.

For the determination of the metal present, the salt is treated with concentrated sulphuric acid in a platinum dish and heated until dense fumes of sulphuric anhydride are given off; silicon fluoride and hydrofluoric acid volatilize, while the metals are left behind as sulphates (cf. Vol. I).

*Determination of Water Present in Fluosilicates, (Rose-Jannasch).**

The water cannot be determined by ignition, because all fluosilicates, even topaz, evolve silicon fluoride when subjected to this treatment (cf. Vol. I, p. 412). If, as proposed by Rose, the

* Rose-Finkener: Lehrbuch der analyt. Ch., Bd. II; and Jannasch, Praktischer Leitfaden der Gewichtsanalyse, Leipzig, 1897, p. 243.

substance is fused with six or eight times as much lead oxide; all the water is evolved, while the fluorine remains behind:



The analysis is best performed according to the directions of Jannasch: A bulb with a capacity of about 25 c.c. is blown near one end of a tube of difficultly fusible glass which is 26 cm. long and 1 cm. wide. Near the middle of the longer side of the tube is placed, between asbestos plugs, a layer 3 to 5 cm. long of pulverized, anhydrous lead oxide, and this end of the tube is connected with two weighed calcium chloride tubes. The substance is placed in the bulb, after which six or eight times as much lead oxide is added and mixed with the substance by carefully revolving the tube. A dry current of air is now conducted through the apparatus and the contents of the bulb are slowly melted. All of the water and often some of the fluorine is thereby expelled, and the latter is absorbed by the layer of lead oxide. At the end of the operation this layer is cautiously heated with a moving flame until no more water condenses in the cooler part of the tube. When all of the water has been driven over into the calcium chloride tubes the latter are weighed with the customary precautions.

GROUP VII.

SILICIC ACID (ALSO TITANIC, ZIRCONIC, TANTALIC, AND NIOBIC ACIDS).

SILICIC ACID, H_2SiO_3 . Mol. Wt. 78.32.

Form: Silicon Dioxide, SiO_2 .

Two cases must be considered:

- (a) The silicate is decomposed by acids.
- (b) The silicate is not decomposed by acids.

(a) Silicates Decomposed by Acids.

These are treated with hydrochloric acid in a porcelain dish and evaporated upon the water-bath with frequent stirring until the residue is obtained in the form of a dry powder. In many cases the decomposition is shown to be complete by the fact that

no gritty particles can be felt with the stirring-rod on the bottom of the dish. If, however, the substance contained quartz or some silicate that is not decomposed by hydrochloric acid, this is not the case and the procedure described on p. 507 may be followed.

The dry powder is moistened with concentrated hydrochloric acid and the covered dish is allowed to stand for 10 or at the most 20 minutes at the ordinary temperature, in order that basic salts and oxides formed during the evaporation and drying may be once more changed to chlorides. Then 100 c.c. of water are added, it is heated to boiling, and after the silicic acid has been allowed to settle, the clear liquid is decanted through a filter supported upon a platinum cone placed in the apex of the funnel. The residue is washed 3 or 4 times with hot water by decantation, then transferred to the filter and washed with hot water until free from chloride.* The precipitate is then dried by means of suction, placed in a platinum crucible, and set aside for the time being. The separation of the silicic acid is now by no means quantitative; as much as 5 per cent. of the total amount may remain in the filtrate. In order to remove this, the solution is once more evaporated to dryness on the water-bath, kept at this temperature for one or two hours (or more), moistened with a few cubic centimeters of concentrated hydrochloric acid, and allowed to stand not more than fifteen minutes.† Hot water is then added, the residue is filtered through a new and correspondingly small filter, and washed with hot water. The amount of silicic acid now remaining in the filtrate amounts to not more than 0.15 per cent. of the total amount, and for most purposes can be neglected. It can be removed, however, by a third evaporation to dryness. The filters containing the silica are ignited wet in a platinum crucible and finally over the blast-lamp, and weighed.‡ The silica obtained is only slightly hygroscopic.

* If the precipitate is not perfectly white, but somewhat brownish owing to the presence of a basic ferric salt, concentrated hydrochloric acid is allowed to run around the upper edge of the filter and is immediately washed down through the funnel by means of a stream of hot water. This is repeated until the filtrate comes through perfectly colorless.

† By being kept in contact with the acid for too long a time some silicic acid will go into solution.

‡ With regard to the temperature at which silica is completely dehydrated,

Testing the Purity of the Silica.

The silica thus obtained is never absolutely pure, except in the analysis of a water-glass. Its purity must always be tested. For this purpose it is covered with 2 or 3 c.c. of water,* a drop of concentrated sulphuric acid is added, and 3 to 5 c.c. of pure hydrofluoric acid (distilled from a platinum retort). The crucible is then placed in a platinum-lined cone (Fig. 16, p. 31) on the water-bath and evaporated under a good hood until no more vapors are expelled. The excess of sulphuric acid is then removed by heating over a free flame. The temperature is raised and the crucible is finally heated over a blast-lamp, after which it is again weighed. This process is repeated until the contents of the crucible (usually Al_2O_3 and Fe_2O_3) are at a constant weight, and this amount is deducted from the weight of impure silica.

Remark.—In order to make the separation of silicic acid more nearly quantitative it has been proposed to heat the residue obtained by evaporation at 110° – 120° C.† This hastens the dehydration, but the temperature of 120° should not be exceeded on account of the danger of the silicic acid being contaminated with basic salts, and because of the tendency for

there is a difference of opinion. Lunge and Millberg (*Zeit. f. angew. Chem.*, (1 97), p. 425) state that the temperature of the Bunsen burner is sufficient, but they operated with silica obtained by the hydrolysis of silicon tetrachloride, in order to obtain a product absolutely free from alkalies. Hillebrand (*Am. Chem. Soc.*, XXIV (1902), p. 362) confirmed the results of Lunge and Millberg with regard to the ignition of a silica obtained in this way, but positively asserts that silicic acid when obtained by the decomposition of an alkali silicate with acid must be ignited over the blast-lamp in order to dehydrate it completely. The results of Hillebrand have been confirmed in the author's laboratory by A. Schröter. Jordis and Kanter (*Z. anorg. Chem.*, 35, 20 (1903)) state that hydrated silica forms a small amount of a chlorine compound with hydrochloric acid. This compound is decomposed on heating only with great difficulty, unless it is treated with water and evaporated to dryness several times. This treatment is recommended by Jordis and Kanter in all accurate silica determinations.

* If the water is not added, the mass will effervesce so strongly that there is danger of losing some of the impure silica.

† James P. Gilbert, *Tech. Quarterly*, III, p. 61, and *Zeit. für anal. Chem.*, XXIX (1 90), 688.

it to recombine with these.* It is, therefore, not advisable to attempt to dehydrate the silica at a temperature higher than that of the water-bath.

(b) Silicates Not Decomposed by Acids.

These must be fused; this can be effected by

(α) *The Sodium Carbonate Method.*

One gram of the very finely powdered substance is placed in a spacious platinum crucible together with 4 to 6 parts of calcined sodium carbonate (or a mixture of equal parts sodium and potassium carbonates) and fused. The powdered silicate should be intimately mixed with the flux and a little sodium carbonate sprinkled on top, the crucible covered and heated for some time over a small flame in order to drive out any moisture present. The temperature is raised gradually until finally the highest heat of a good Teclu burner is obtained; or, lacking the latter, a blast-lamp should be used. As soon as the mass melts quietly and there is no further evolution of carbon dioxide, the decomposition is complete. The crucible is seized with a pair of crucible tongs having platinum points and placed in cold water, but so that the water does not enter the crucible. By means of this rapid cooling the melt is usually detached from the sides of the crucible and can be removed by simply turning the crucible upside down and gently tapping its sides.† The melt is received in a good-sized beaker, covered with water, a sufficient quantity of strong hydrochloric acid is added, and the beaker covered with a watch-glass. A lively evolution of carbon dioxide at once takes

* When considerable magnesium was present, more silica was found in the filtrate after igniting at 280° than when dried on the water-bath. This is due to the fact that magnesia formed by hydrolysis reunites with the silica to form magnesium silicate, and the latter is decomposed by hydrochloric acid with the formation of soluble silicic acid.

† Instead of the cold water a blast of air may be used. Then, when the melt is still warm but not hot enough to cause spattering, the addition of water enough to cover it will usually help to loosen the melt from the sides of the crucible. Hillebrand recommends the rotation of the contents of the crucible while still molten so that a relatively thin layer solidifies on the sides and bottom of the crucible.

place, but in proportion as silicic acid separates out, the inner part of the cake gradually becomes coated with a film of silicic acid which protects it from the further action of the acid. Consequently it is necessary to break up the cake from time to time by means of a glass rod until finally there is no further evolution of a gas and no more hard lumps remain. When manganese is present the melt is colored green and the solution is pink. The latter is heated until this pink color disappears and is then transferred to a platinum dish (or lacking this, one of porcelain may be used). The small amount of the melt adhering to the sides of the crucible is transferred to the contents of the dish by means of water and hydrochloric acid. The solution is then analyzed as described on page 485.

Remark.—If the fusion cannot be removed from the crucible, it is placed, together with its cover, in the beaker and treated as above.

In this case, if the melt was very green-colored, it should not be decomposed with hydrochloric acid, but with nitric acid, for the chlorine evolved by the action of the hydrochloric acid upon the manganate would attack the platinum.

Substances containing considerable fluorine cannot be treated as above, for silicon fluoride will be lost by volatilization. In this case it is necessary to use the old method of Berzelius. The melt from the sodium carbonate fusion is extracted with water, as in the determination of fluorine (p. 472), and the greater part of the silica removed by means of ammonium carbonate. The precipitate is filtered off, ignited, and weighed.

The silicic acid remaining in the filtrate is precipitated by means of ammoniacal zinc hydroxide. The precipitate thus obtained, consisting of zinc oxide and zinc silicate, is decomposed with hydrochloric acid and the silica obtained by evaporation on the water-bath as usual. As a rule, the insoluble part of the melt contains silicic acid, and this must also be removed by evaporation with hydrochloric acid. All three silica precipitates are ignited together and the purity of the silica tested.

Besides the sodium carbonate method for the analysis of silicates not decomposable with acids a great number of other methods have been proposed, but of these only the following will be mentioned here.

*(β) Lead Oxide Method of Jannasch.**

This analysis is interesting because it permits of an exact determination of the alkalis and of silicic acid in the same sample.

Inasmuch as commercial lead oxide (litharge) is not free from impurities, it is prepared for the analysis by the ignition of pure lead carbonate.

The lead carbonate is prepared by adding the theoretical amount of ammonium carbonate to a boiling solution of lead acetate. The precipitate is washed several times by decantation with hot water, then transferred to a hardened filter, and completely washed, using suction. The mass is finally carefully removed from the filter-paper and dried on the water-bath.

Procedure.—For each gram of the silicate 10–12 gms. of lead carbonate are used. First of all a little lead carbonate is placed in the crucible, then the very finely powdered substance, and after mixing thoroughly with a platinum spatula the covered crucible is heated for fifteen to twenty minutes over a flame which is not more than 3–4 cm. high, by which means the greater part of the carbon dioxide is expelled. The contents of the crucible are then more strongly heated until fusion is effected, taking care that the flame used is strictly non-luminous; the lower third of the crucible, and no more, may be heated to redness.

After fusing for ten to fifteen minutes the decomposition is complete, and the covered crucible is quickly touched into cold water, but so that its contents remain dry. The melt is placed in a platinum dish, covered with hot water and a sufficient quantity of concentrated nitric acid and evaporated on the water-bath, breaking up the melt with a stirring-rod as much as possible. When the cake is completely disintegrated, as is shown by there remaining no more hard yellow pieces and only slightly colored flocks of silicic acid floating in the liquid, the latter is evaporated on the water-bath until a dry powder is obtained; this is moistened with concentrated nitric acid and once more evaporated

* Gaston Bong, *Zeit. für anal. Chem.*, XVIII (1879), p. 270, first proposed that silicates be decomposed by fusion with red lead (Pb_2O_3), but Jannasch in his *Praktisches Leitfaden der Gewichtsanalyse* has greatly improved the method.

to complete dryness. The dry residue is moistened with 20 c.c. of concentrated nitric acid, and allowed to stand fifteen minutes; 100 c.c. of water are added, and the liquid is heated for twenty minutes on the water-bath. The residue of silicic acid is filtered off, washed first with hot water containing nitric acid, then with pure water, and weighed after the usual ignition.

Remark.—In the analysis of minerals containing fluorine, e.g. topaz, Jannasch finds that the results obtained are about 0.5–1 per cent. lower than when the Berzelius method is used. In such a case this method of decomposition is used only for the determination of the metals and of the alkalies, after introduction of hydrogen sulphide and removal of the lead.

ANALYSIS OF SILICATES.

Orthoclase.

Constituents: silicic acid (63–70 per cent.); aluminium oxide (16–20 per cent.); ferric oxide (0.3 per cent.); potassium oxide (8–16 per cent.); sodium oxide (1–6 per cent.); and often small amounts of calcium oxide, magnesium oxide, and in rare cases barium and ferrous oxides.

Preparation of the Substance for Analysis.

The substance is placed upon a thick steel plate within a steel ring (about 2 cm. high and 6 cm. in diameter) and broken into small pieces by means of a hardened steel hammer; the pieces are then reduced to a coarse powder. The latter is placed in an agate mortar in small portions and ground as fine as possible and preserved in a glass-stoppered bottle. In this way from 5–6 gms. of powder are obtained.

By this means, as proposed by Hillebrand, there is less danger of contaminating the substance with small particles of iron than when a so-called steel mortar is used, especially after the latter has been worn rough on its inner surface. Further, the practice of passing the powder through bolting-cloth is to be avoided when possible, as in this way the substance becomes contaminated with

fibres of cloth and too large an amount of ferrous iron will be found.

Weighing the Substance.

It is customary to dry the powder before weighing at 100–110° C. until a constant weight is obtained. If there is danger of losing combined water by this procedure, it has been recommended to dry the powder in a vacuum over concentrated sulphuric acid. The practice of drying the substance in either of the above ways is, however, to be discountenanced. It is far better to use the air-dried substance for the analysis, and to determine the moisture in a separate sample. This is more accurate, because the dry silicate powder is hygroscopic, so that a portion weighed out to-day is likely to contain a different amount of moisture than one taken to-morrow, and this is not the case when the air-dried powder is taken for the analysis. Further, as Hillebrand has conclusively shown, chemically combined water is not only likely to be expelled by heating at 100° C., but also by drying in a vacuum over sulphuric acid. This is particularly true of the zeolites. In the case of orthoclase, however, only about 0.1 per cent. of moisture is present, so that in this particular case accurate results will be obtained by either method.

For the analysis two portions must be taken, each amounting to about 1 gm. in weight. The first serves for the determination of SiO_2 , $\text{Al}_2\text{O}_3 + \text{Fe}_2\text{O}_3$, CaO , and MgO ; the second for that of the alkalies.

Determination of Silica, Aluminium, etc.

About 1 gm. of the air-dried substance is placed in a spacious platinum crucible, dried for one hour at 105°–7° C., cooled in a desiccator, and weighed. The difference in weight represents the amount of hygroscopic moisture.

The dry substance is mixed with 4 to 5 gms. of calcined sodium carbonate by means of a platinum spatula, and the silicic acid is

determined exactly as described on p. 488.* The silica obtained is treated with sulphuric and hydrofluoric acids, as described on p. 487, and the residue of Al_2O_3 in the crucible is placed at one side for the present.

Determination of Aluminium and Ferric Oxides.

The filtrate from the silicic acid contains, besides the chlorides of aluminium, iron, calcium, and magnesium, weighable amounts of platinum, partly coming from the crucible in which the fusion was made, and partly from the action of the ferric chloride and hydrochloric acid upon the platinum dish in which the evaporation took place (cf. p. 110, foot-note).

To remove the platinum, the solution is heated to boiling and hydrogen sulphide is passed into it. The mixture of platinum sulphide and sulphur is filtered off and the solution is boiled to expel the excess of hydrogen sulphide. The iron is then completely oxidized back to the ferric state by the addition of bromine water and boiling until the excess of the latter is expelled. After this about 10 c.c. of double-normal ammonium chloride solution are added and the boiling-hot solution is precipitated by the addition of a slight excess of ammonia, free from carbonate (cf. p. 149, *Remark*).

* Formerly a single evaporation of the melt with hydrochloric acid was made, and it was assumed that the silica remaining in solution was quantitatively precipitated with the iron and aluminium by the addition of ammonia. After obtaining the weight of the ignited ammonia precipitate it was fused with potassium pyrosulphate and the melt taken up in the dilute sulphuric acid; the residual silica was filtered off and weighed. The filtrate was analyzed as above described. Hillebrand has recently shown that this procedure is inaccurate. In the first place, the silica remaining in solution is not completely thrown down with the iron and aluminium precipitate, and in the second place the silicic acid is not absolutely insoluble in dilute sulphuric acid. Hillebrand found that from a solution containing 0.20 gm. Al_2O_3 and 0.0101 gm. SiO_2 , as much as 0.0007 gm. SiO_2 could be detected in the filtrate from the ammonia precipitate. From the potassium pyrosulphate melt he succeeded in obtaining, according to the old method, only 0.0033 gm. SiO_2 , while he obtained, by evaporating the solution until fumes of sulphuric acid came off and subsequently diluting with water, as much as 0.0060 gm. SiO_2 , or about twice as much as was at first insoluble.

The precipitate is allowed to settle, after which it is filtered, and washed twice by decantation with hot water. It is then dissolved by running hot dilute hydrochloric acid through the filter into the beaker containing the greater part of the precipitate. The precipitation with ammonia is repeated as before, and after filtering and washing by decantation, the precipitate is transferred to the filter and washed until free from chloride with water containing ammonium nitrate. The precipitate is allowed to drain as completely as possible, and is ignited wet in the crucible containing the residue obtained from the treatment of the impure silica with sulphuric and hydrofluoric acids. After igniting strongly over a good Teclu burner (or the blast-lamp) the crucible is weighed; its contents represents the sum of the aluminium and ferric oxides.

For the determination of the ferric oxide, the mixed oxides are fused with potassium pyrosulphate as described on p. 109. The decomposition is complete after two to four hours. The melt is dissolved in water containing a little sulphuric acid and the iron is determined, after previous reduction with hydrogen sulphide, by titration with potassium permanganate (cf. p. 99). If the weight of the Fe_2O_3 is deducted from the weight of $\text{Fe}_2\text{O}_3 + \text{Al}_2\text{O}_3$, the weight of Al_2O_3 is obtained.*

Determination of Calcium.

The combined filtrates from the ammonia precipitate are evaporated to a small volume, heated to boiling, and precipitated by means of a boiling solution of ammonium oxalate. After standing twelve hours the calcium oxalate is filtered off, and with small amounts of calcium this precipitate is ignited wet in a platinum crucible and weighed. If, however, considerable calcium is present, †

* The amount of iron and aluminium can be determined more quickly, though less accurately, as follows: The moist ammonia precipitate is dissolved in hot dilute sulphuric acid and diluted to a volume of exactly 250 c.c. After thoroughly mixing, 100 c.c. are removed by means of a pipette into a beaker and a second portion of the same volume is placed in a 200-c.c. flask. In the first portion the sum of $\text{Fe}_2\text{O}_3 + \text{Al}_2\text{O}_3$ is determined by precipitating with ammonia, filtering, igniting, and weighing; in the other portion the iron is reduced by hydrogen sulphide and then titrated with permanganate.

† Cf. pp. 76-78.

the moist precipitate is redissolved in hydrochloric acid, and again precipitated by the addition of ammonia and a little more ammonium oxalate. The precipitate is ignited strongly, and weighed as CaO. (Cf. p. 70.)

Testing of the Calcium Oxide Precipitate for Barium.

Although it is usually unnecessary to make either a qualitative or quantitative test for barium in a sample of orthoclase, yet it is likely to be present in traces so that it may be well to show how this can be done. As far as the author knows strontium has never been found in orthoclase. On account of the solubility of barium oxalate in a solution of ammonium oxalate, the barium will rarely be found in the calcium precipitate when a double precipitation is made, except when it is present to an extent of more than 3 or 4 mgms.*

To test the calcium precipitate for barium, it is dissolved in nitric acid, evaporated to dryness, and heated for some time at 140° C. The calcium nitrate is dissolved out by ether-alcohol (p. 79, *a*), and any residue remaining behind is tested in the spectroscope for barium. If an appreciable amount of the latter is found, the calcium must be determined in the ether-alcohol extract. It is carefully evaporated to dryness, the residue dissolved in a little water and precipitated as before by the addition of ammonium oxalate. After standing twelve hours the precipitate is filtered off, washed, ignited, and weighed. If no barium is found with the lime, it is by no means safe to conclude that the former is absent; it can very well have gone into the filtrate from the double precipitation of calcium. This amount will be precipitated with the magnesium as barium phosphate unless it is removed as indicated below.

For the quantitative determination of barium a separate portion of the substance is taken (see below).

Determination of Magnesium.

The combined filtrates from the calcium oxalate are evaporated to dryness, ignited in a porcelain dish, and the residue dis-

* W. F. Hillebrand, Journ. Am. Chem. Soc., 16 (1894), p. 83.

solved in water to which a few drops of hydrochloric acid have been added. The carbonaceous residue is filtered off, a drop of sulphuric acid added, and the solution is allowed to stand twelve hours to see if any precipitate of barium sulphate will form. In the latter case, the precipitate is filtered off and tested for barium according to Vol. I, in the filtrate from the barium sulphate the magnesium is determined as described on page 65.

Determination of Barium.

If the qualitative tests have shown the presence of barium, a larger sample of the substance is weighed out (about 2 gms.) moistened in a platinum dish with 10 c.c. of sulphuric acid (1:4) and 5 c.c. of hydrofluoric acid are added. The liquid is evaporated on the water-bath, with frequent stirring, until the mineral is completely decomposed, which is recognized by there no longer being any sandy particles perceptible on stirring with a platinum spatula. Frequently a further addition of hydrofluoric acid is necessary. When the decomposition is complete, the greater part of the sulphuric acid is removed by heating the contents of the dish in an air-bath. After cooling, the residue is taken up in water, and the barium sulphate is filtered off, and ignited wet in a platinum crucible. The precipitate thus obtained always contains small amounts of calcium sulphate which must be eliminated. To accomplish this, the residue in the crucible is dissolved in a little hot concentrated sulphuric acid, and after cooling the solution is diluted with cold water. The barium sulphate is now completely free from calcium; it is filtered off, ignited, and weighed.

Determination of the Alkalies.

(a) *Method of J. Lawrence Smith.**

Principle.—The substance is heated with a mixture of 1 part ammonium chloride and 8 parts calcium carbonate. By this means the alkalies are obtained in the form of chlorides, while the remaining metals are for the most part left behind as oxides,

* Am. Jour. Science [2], 50, 269, and Ann. d. Chem. u. Pharm., 159, 82 (1871).

and the silica is changed to calcium silicate, as represented by the following equations:

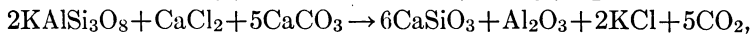
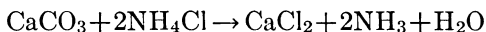

The alkali chlorides together with the excess calcium chloride can be removed from the sintered mass by leaching with water, while the other constituents remain undissolved.

Preparation.—The ammonium chloride necessary for the determination is prepared by subliming the commercial salt; the calcium carbonate by dissolving the purest calcite obtainable in hydrochloric acid and precipitating with ammonia and ammonium carbonate. This last operation is performed in a large porcelain dish. After the precipitate has settled, the clear solution is poured off and the precipitate is washed by decantation until free from chlorides. The product thus obtained contains traces of alkalies, but the amount present is determined once for all by a blank test and a corresponding deduction made from the results of the analysis; it is usually sodium chloride and amounts to 0.0012-0.0016 gm. for 8 gms. calcium carbonate. The decomposition was performed by Smith in a finger-shaped crucible about 8 cm. long and with a diameter of about 2 cm. at the top and 1½ cm. at the bottom. Such a crucible is suitable for the decomposition of about 0.5 gm. of the mineral. A larger quantity can be analyzed in a somewhat wider crucible.

Filling the Crucible.—About 0.5 gm. of the mineral is mixed with an equal quantity of sublimed ammonium chloride by trituration in an agate mortar, then 3 gms. of calcium carbonate are added and intimately mixed with the former. The mixture is transferred to a platinum crucible with the help of a piece of glazed paper, and the mortar is rinsed with one gram of calcium carbonate, which is added to the contents of the crucible.

The Ignition.—The covered crucible is placed in a slightly inclined position and gradually heated over a small flame until no more ammonia is evolved* (this should take about fifteen

* During this part of the operation the heat should be kept so low that ammonium chloride does not escape. The latter is dissociated into ammonia and hydrochloric acid by the heat, and the acid unites with the calcium carbonate to form calcium chloride. It is possible to decompose the silicate by using calcium chloride alone. A method for doing this has been worked out.

minutes), then the temperature is raised until finally the lower three-fourths (and no more) of the crucible are brought to a dull red heat, and this temperature is maintained for 50–60 minutes. The crucible is then allowed to cool and the sintered cake usually can be removed by gently tapping the inverted crucible. Should this not be the case, it is digested a few minutes with water, which serves to soften the cake so that it can be readily washed into a large porcelain, or, better, platinum dish. The covered dish is heated with 50–75 c.c. of water for half an hour, replacing the water lost by evaporation, and the large particles are reduced to a fine powder by rubbing with a pestle in the dish. The clear solution is decanted through a filter and the residue is washed four times by decantation, then transferred to the filter and washed with hot water until a few cubic centimeters of the washings give only a slight turbidity with silver nitrate. To make sure that the decomposition of the mineral has been complete, the residue is treated with hydrochloric acid; it should dissolve completely, leaving no trace of undecomposed mineral.

Precipitation of the Calcium.—The aqueous solution is treated with ammonia and ammonium carbonate, heated and filtered. As this precipitate contains small amounts of alkali, it is redissolved in hydrochloric acid and the precipitation with ammonia and ammonium carbonate is repeated. The combined filtrates are evaporated to dryness in a porcelain or platinum dish, and the ammonium salts are removed by careful ignition over a moving flame.* After cooling, the residue is dissolved in a little water and the last traces of calcium are removed by the addition of ammonia and ammonium oxalate. After standing twelve hours, the calcium oxalate is filtered off and the filtrate is received in a weighed platinum dish, evaporated to dryness, and gently ignited. After cooling the mass is moistened with hydrochloric acid in order to transform any carbonate into chloride, the evaporation and ignition is repeated, and the weight of the contents of the dish is determined; this represents the amount of alkali chloride present. To determine potassium, the residue is dissolved in water, and the

* Before igniting, it is well to heat the contents of the dish in a drying-oven at 110°. By this means there is no danger of loss by decrepitation.—[Translator.]

potassium is precipitated as chloroplatinate (cf. p. 44) or as perchlorate (cf. p. 50). The sodium is determined by difference.

(b) *The Hydrofluoric Acid Method of Berzelius.*

About 0.5 gm. of the mineral is weighed into a platinum dish, 2 c.c. of water and 0.5 c.c. of concentrated sulphuric acid are added, and mixed with the substance by means of a platinum spatula; after cooling about 5 c.c. of pure, concentrated hydrofluoric acid, which has been distilled from a platinum retort with the addition of a little potassium permanganate, are added.* The liquid is evaporated on the water-bath, frequently stirring with the platinum spatula, until no more hydrofluoric acid is expelled and no more hard particles can be felt at the bottom of the dish.

The dish is heated in an air-bath until the greater part of the sulphuric acid is removed; this is necessary to make sure that the hydrofluoric acid is completely expelled. It is not advisable, however, to remove all of the sulphuric acid, on account of the danger of forming insoluble basic salts. The mass is allowed to cool, covered with 200 c.c. of water, and digested until all of the residue has gone into solution.† The sulphates are now transformed to chlorides by precipitation with as slight an excess of barium chloride as possible; and then, without stopping to filter off the barium sulphate, the aluminium, calcium, and excess of barium are precipitated by the addition of ammonia and ammonium carbonate. The precipitate is allowed to settle, washed four times by decantation, then transferred to the filter and washed free from chloride. The filtrate is evaporated to dryness, and the ammonium salts removed by gentle ignition. A few drops of hydrochloric acid are added, and the magnesium is removed by adding barium hydroxide solution until slightly alkaline, boiling and filtering. The filtrate is treated with ammonia and ammonium carbonate, boiled, and the precipitated barium carbonate filtered off. This filtrate is again evaporated to dryness, the ammonium salts are expelled, the residue is dissolved in a little water, and a little more barium carbonate is precipitated by the addition of ammonia and ammonium car-

* The permanganate serves to destroy organic matter that is likely to be present in commercial hydrofluoric acid.

† If barium was present, it is left behind as the sulphate.

bonate. This treatment is repeated until finally the addition of ammonia and ammonium carbonate produces no further precipitation. The last filtrate is evaporated to dryness, gently ignited, moistened with hydrochloric acid, again evaporated, ignited and weighed; this represents the weight of the alkali chlorides together with a small amount of magnesium chloride. The chlorides are dissolved in a little water, and the potassium precipitated as potassium chlorplatinat \cdot (p. 44). If the corresponding amount of potassium chloride is deducted from the first weight, the amount of sodium chloride plus the small amount of magnesium chloride will be obtained. In order to determine the latter, the alcoholic filtrate from the potassium chlorplatinat \cdot precipitate is evaporated to dryness on the water-bath (the water in the bath must not boil), and the residue is dissolved in a little water and washed into a small flask. The latter is now fitted with a rubber stopper containing two holes, and through these, two right-angled pieces of glass tubing are introduced, one reaching to the bottom of the stopper and the other until it almost touches the liquid in the flask. The solution is now heated to boiling so that steam escapes from both of the tubes. After boiling two minutes we can assume that the air is completely expelled from the flask; the short tube is connected with a hydrogen generator and a rapid current of hydrogen is conducted through the apparatus, while at the same time the flame is removed from beneath the flask and the long tube is closed by means of a piece of rubber tubing containing a glass rod. The liquid is allowed to cool completely, and the air-space above will be entirely filled with hydrogen. As the hydrogen is absorbed by the liquid, the sodium and magnesium chlorplatinates are reduced to chloride with the deposition of metallic platinum, which floats on the liquid in the form of dendrites:

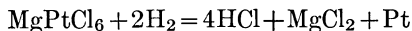
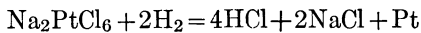

The flask is placed in a lukewarm water-bath, frequently shaken, and the hydrogen is allowed to act upon the solution until the reduction is shown to be complete by the liquid becoming perfectly colorless. The connection with the hydrogen generator is now broken and a rapid current of carbon dioxide is conducted

through the solution for two minutes through the longer tube in order to remove the hydrogen. This is necessary, as otherwise on opening the flask there is likely to be an explosion between the hydrogen and oxygen, owing to the catalytic action of the platinum. The platinum is filtered off, the filtrate concentrated, and the magnesium precipitated by the addition of ammonia and sodium phosphate. After standing twelve hours, the magnesium ammonium phosphate is filtered off and the magnesium determined as magnesium pyrophosphate. The corresponding weight of $MgCl_2$ is deducted from the weight of $NaCl + MgCl_2$, and in this way the amount of $NaCl$ is determined.

Remark.—This method is in very general use, and the results obtained agree closely with those by the J. Lawrence Smith method. Many silicates, such as the feldspars, are readily decomposed by the action of sulphuric and hydrofluoric acids; * others, such as certain specimens of tourmaline, only with difficulty. According to Jannasch the members of the andalusite group are not completely decomposed by hydrofluoric acid, but this can be effected by strongly igniting with ammonium fluoride. For this purpose the ignited mineral is placed in a platinum dish, covered with 10 c.c. of ammonia, evaporated to dryness, diluted with water, strongly acidified with concentrated hydrofluoric acid, and again evaporated to dryness. The dish is placed in a nickel beaker and ignited quite strongly, until finally the excess of ammonium fluoride is driven off. The residue is now treated with sulphuric acid (1:2) in order to decompose salts of hydrofluosilicic acid, evaporated on the water-bath as far as possible, and then the greater part of the sulphuric acid is removed. From this point the procedure is the same as in the regular Berzelius method.

The Smith method is always applicable and has the advantage, that the magnesium is practically completely removed at the start.

Instead of precipitating the potassium as chloroplatinate, the perchlorate method described on p. 50 can be used to advantage. In this case the magnesium can be precipitated in the alcoholic solution by the Schaffgottsche Method described on p. 69, previous to the expulsion of ammonium salts and treatment with perchloric acid.

* Many silicates can be decomposed by evaporation with hydrofluoric and hydrochloric acids. F. Hinder, *Z. anal. Chem.*, 1906, 332.

Analysis of Lepidolite.

Lepidolite is a member of the mica group and contains lithium and fluorine with the following composition:



SiO_2 = 40 to 45 per ct.; Al_2O_3 = 19 to 38 per ct.; MnO = 0 to 5 per ct.; MgO = 0 to 0.5 per ct.; K_2O = 4 to 11 per ct.; Li_2O = 1 to 6 per ct.; Na_2O = 0 to 2 per ct.; F = 1 to 10 per ct.; H_2O = 1 to 3 per ct.

Besides the above, calcium, iron, phosphoric acid, and chlorine are frequently found, and in rare cases small amounts of caesium and rubidium are present.

The determination of the silicic acid, aluminium, iron, manganese, and magnesium is effected as in the case of the orthoclase analysis, except that in this case the manganese must be separated from the iron and aluminium as described on p. 149 or 152.

Determination of the Alkalies.—The weight of $\text{NaCl} + \text{KCl} + \text{LiCl}$ is determined by one of the methods given under the analysis of orthoclase, and the potassium weighed as potassium chloroplatinate. The platinum is then removed by the treatment with hydrogen, or the solution is heated to boiling and the platinum is precipitated as the sulphide by the introduction of hydrogen sulphide. The filtrate free from platinum is evaporated to dryness and the lithium separated from the sodium as described on p. 53 or p. 55.

Determination of Fluorine.—This determination is the same as in the case of analysis of fluorine in calcium fluoride (p. 471), except that it is unnecessary to add any silica, for the mineral itself already contains a sufficient quantity.

Determination of Water.—This is effected by the method of Rose-Jannasch (p. 484).

Determination of Ferrous Iron in Silicates and Rocks.

The very finely powdered, but not bolted, mineral contained in a platinum dish is covered with 5 to 10 c.c. of dilute sulphuric acid (1:4) and placed upon the little triangle (*a*) Fig. 81, made of glass or, better, platinum. This is placed in the lead vessel *C* and the latter rests in a paraffin bath (*B*). After the cover is placed upon

C, a rapid current of carbon dioxide is passed through *A*, whereby the air within the apparatus will be replaced in about three minutes. The cover is quickly removed, and 5 to 10 c.c. of concentrated hydrofluoric acid are added. The cover is immediately replaced, and the current of carbon dioxide continued, while the contents of the dish are repeatedly stirred during the whole operation by means of a platinum spatula or piece of coarse wire introduced through the other hole in the cover.* At the same time the paraffin bath is heated to 100° C. and kept at this temperature for about an hour. As soon as no more gritty particles

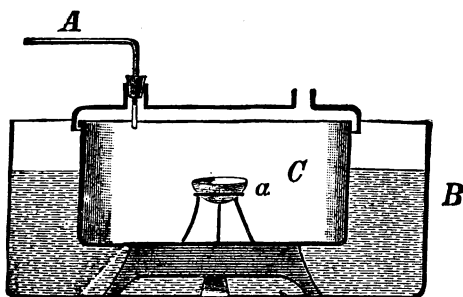

FIG. 81.

are to be felt, the temperature of the bath is raised to about 120° C. in order to remove the large excess of hydrofluoric acid. This requires about another hour. The dish is then allowed to cool in the carbon dioxide atmosphere and its contents are finally washed into 400 c.c. of cold distilled water, 10 c.c. of concentrated sulphuric acid are added, and the solution is titrated with a potassium permanganate solution of known strength until a pink color is obtained which is permanent for several seconds. This endpoint is fugitive in proportion to the amount of hydrofluoric acid remaining in the solution.

Remark.—The above method has been used in the author's laboratory with success for several years. It is a modification of Cooke's† method in which the decomposition with hydrofluoric

* In Fig. 81, this second opening is incorrectly shown. It should really be in the middle of the cover directly over the evaporating-dish.

† J. P. Cooke, *Am. J. Science* [2], **44**, p. 347 (1867).

acid took place under a glass funnel upon the water-bath. In this case a large amount of hydrofluoric acid remains in solution and it is difficult to obtain a sharp end-point.

Another method for the determination of the amount of ferrous iron present in insoluble silicates is that of Mitscherlich. The silicate is decomposed in a closed tube with sulphuric acid ($8 \text{ H}_2\text{SO}_4 : 1 \text{ H}_2\text{O}$) under pressure, and the resulting solution titrated with potassium permanganate. This method usually gives good results in the case of a silicate analysis, but it is worthless for the analysis of rocks containing pyrite or other sulphides, which on treatment with sulphuric acid are decomposed with evolution of SO_2 .* The latter serves to reduce iron that was originally present in the ferric form, so that a too high result will be obtained.

Determination of Small Amounts of Titanium in Rocks.

The colorimetric method of A. Weller is best suited for this purpose, and is to be preferred over all gravimetric methods.

Procedure.—The silicic acid is removed exactly as in the analysis of orthoclase (p. 491) and in the filtrate the iron, aluminium, titanium, zirconium (chromium and vanadium) are separated from the manganese, magnesium, and calcium, by the acetate method. The precipitate thus obtained still contains traces of manganese, so that it is dissolved in dilute hydrochloric acid and reprecipitated by ammonia. The precipitate is ignited in the same crucible in which the residue from the impure silica is contained (small amounts of titanium are likely to be in this residue) fused with potassium pyrosulphate, and the melt dissolved in water containing sulphuric acid. Any insoluble silicic acid is filtered off and the titanium determined in the filtrate as described on p. 100 by treatment with hydrogen peroxide.

Remark.—In rock analysis it is convenient to determine the titanium after the determination of the total iron. For this purpose the solution of the potassium pyrosulphate melt is saturated with hydrogen sulphide in order to precipitate the platinum

* L. I. de Koninck, *Zeit. für anorg. Chem.*, 26 (1901), 125, and Hillebrand and Stokes, *J. Am. Chem. Soc.*, XXII (1900), p. 625. See also Stokes, *Am. J. Sci.*, Dec., 1901.

and reduce the iron, and the filtrate from the platinum sulphide is titrated with potassium permanganate after expelling the excess of hydrogen sulphide, as described on p. 109. The solution is afterwards concentrated to about 80 c.c., and the titanium determined as above.

Of the gravimetric methods, that of Gooch is best suited (p. 116), but even this fails in the presence of zirconium (Hillebrand), so that it is in all cases better to employ the colorimetric method.

If it is desired to analyze a rock for titanium alone, about one gram should be treated with hydrofluoric and sulphuric acids (see p. 499), the greater part of the sulphuric acid removed by volatilization, in order to make sure that the hydrofluoric acid is expelled, and the residue taken up in water. From this solution the titanium is determined as above.

Determination of Zirconium and Sulphur in Rocks.

W. F. Hillebrand.*

About 2 gms. of the substance are fused with 5 or 6 times as much sodium carbonate (free from sulphur) and 0.5 gm. potassium nitrate in a large platinum crucible. The crucible should be placed through a hole in a piece of asbestos and held in an inclined position so that none of the sulphur from the flame can come in contact with the contents of the crucible. The melt is taken up in water, a few drops of alcohol are added in order to reduce any manganate to manganous salt, the solution is filtered, and the precipitate washed with dilute soda solution. The filtrate contains all the sulphur in the presence of sodium silicate,† while the residue contains all the barium and zirconium together with the remaining oxides which were present in the rock.

(a) Treatment of the Filtrate.

This should amount to 100–250 c.c. in volume; it is acidified with hydrochloric acid, heated to boiling, and precipitated with hot barium chloride solution. After standing twelve hours the barium sulphate is filtered off and weighed.

* Bulletin of the U. S. Geolog. Survey (1900), p. 73.

† Besides sulphuric and silicic acids the filtrate may contain chromic (yellow color), vanadic, molybdic, phosphoric, arsenic, and tungstic acids.

According to Hillebrand it is not necessary to evaporate the solution to remove the silicic acid before precipitating the sulphuric acid, for from a dilute solution silicic acid is never precipitated with the barium sulphate.

(b) *Treatment of the Residue.*

The residue is washed by means of a stream of dilute sulphuric acid (1:20) into an evaporating-dish, and, after digesting for some time, it is filtered through the original filter. The filtrate contains aluminium, iron, and the greater part of the zirconium. The residue contains the rest of the zirconium together with barium sulphate and some silicic acid; after being washed, it is ignited in a platinum crucible and freed from silica by evaporation with sulphuric and hydrofluoric acids. The residue in the crucible is then taken up in hot dilute sulphuric acid and filtered. The insoluble portion can be used for the determination of barium (see below).

The two sulphuric acid filtrates, containing at the most only 1 per cent. of this acid, are treated with hydrogen peroxide and a few drops of disodium phosphate. Aluminium and iron are not precipitated on account of the acid present, and only traces of titanium are thrown down, while all of the zirconium is precipitated as phosphate, after standing 24 to 48 hours.

If the yellow color of the solution should fade away, a little more hydrogen peroxide is added; the precipitate is filtered off, and, even when it is small in amount, it is purified from the titanium as follows: The filter, together with the precipitate, is ignited, fused with a little sodium carbonate, the melt extracted with water and filtered. This residue is likewise ignited, but it is now fused with potassium pyrosulphate, and the fusion dissolved in hot water containing a few drops of dilute sulphuric acid. The solution is poured into a small Erlenmeyer flask of about 20 c.c. capacity, a few drops of 4 per cent. hydrogen peroxide and a few drops of sodium phosphate solution are added, and after standing 1 or 2 days the precipitate is filtered off. The latter is now free from titanium in nearly every case, and after ignition it is weighed as zirconium phosphate. Although zirconium phosphate theoretically contains 51.8 per cent. ZrO_2 , there will be no appreciable error introduced if it is

assumed that one-half the weight of the precipitate represents the amount of this oxide present.

Determination of Barium.

The above-mentioned precipitate containing all the barium as sulphate, in the presence of calcium and perhaps strontium, always contains a little silicic acid. In order to remove the latter, it is heated with hydrofluoric and sulphuric acids and the residue is fused with sodium carbonate. The melt is treated with water and the carbonates of barium and calcium are filtered off, washed, and then dissolved in hot dilute hydrochloric acid. From this solution the barium is precipitated by the addition of a slight excess of sulphuric acid and ignited wet in a platinum crucible. The precipitate thus obtained contains a small amount of calcium sulphate, which must be eliminated. For this purpose the residue is dissolved in the crucible by hot concentrated sulphuric acid, and after cooling the solution is poured into water. In this way a precipitate of barium sulphate free from calcium is obtained. It is ignited and weighed.

Separation of Soluble from Insoluble Silicic Acid: Lunge and Millberg.*

Frequently a mixture of silicates is to be analyzed which is partly decomposed on treatment with acids, with the separation of gelatinous silicic acid, and partly unaffected. The silicic acid deposited from solution by the addition of acids is soluble in 5 per cent. sodium carbonate solution, while quartz and feldspar are not appreciably attacked by the latter (cf. Vol. I. pp. 413, 414).

If it is desired to separate the deposited silicic acid from the unattached silicate (usually feldspar and quartz), the substance is treated with acid (hydrochloric or nitric) and evaporated on the water-bath until a dry powder is obtained. This is moistened with acid, diluted, boiled, and filtered. After washing, the residue is digested with 5 per cent. sodium carbonate solution on the water-bath, in a porcelain dish for fifteen minutes. It is then filtered, washed first with soda solution and finally with water.

* *Zeitschr. f. angew. Chemie*, 1897, pp. 393 and 425.

If a turbid filtrate should be obtained, a little alcohol is added to the wash water, after which the filtrate will at once run through clear.

The alkaline filtrate contains the soluble silicic acid; this can be determined by acidifying and evaporating to dryness. The residue from the sodium carbonate treatment, consisting of quartz and feldspar, is weighed. In order to determine the quartz, the mixture is acted upon by sulphuric and hydrofluoric acids, the excess of the latter is removed by heating with sulphuric acid, and the cold residue is dissolved in water, precipitated with ammonia, and the alumina weighed. If this weight is multiplied by 5.41, the corresponding amount of feldspar is obtained, and if this is deducted from the weight of the quartz + feldspar, the weight of the quartz will be found.

Determination of Soluble Silicic Acid in Clay.

Clay contains besides alumina, sand (quartz + breccia) and small amounts of calcium and magnesium carbonates.

About 2 gms. of the substance, after having been dried at 120°, and being in the form of a not-too-fine powder, are moistened with water, and a mixture of 100 c.c. water and 50 c.c. concentrated sulphuric acid * is added. The porcelain dish is covered with a watch-glass and heated over a free flame until dense fumes of sulphuric acid vapors are evolved. The contents of the dish are allowed to cool, 150 c.c. of water and 3 c.c. of concentrated hydrochloric acid are added, the solution boiled for fifteen minutes, filtered, washed completely, and the mixture of soluble silicic acid, quartz, and insoluble silicate is treated as above.

Remark.—It was formerly the custom to separate the soluble silica from the insoluble silica by boiling with potassium hydroxide solution. According to the experiments of Lunge and Millberg, however, this is not permissible because quartz is perceptibly soluble in caustic potash solution. If, on the other hand, the substance is obtained in a very finely-divided condition, even sodium carbonate solution cannot be used for the same reason.

* Alexander Subech, Die chem. Industrie 1902. p. 17.

Analysis of Chromite.

Although chromite (chrome iron ore) is not a silicate, it is insoluble in all acids, and can be brought into solution by fusion with alkali carbonates, or borates, so that its analysis will be discussed at this place.

Chromite contains 18 to 39 per cent. FeO, 0 to 18 per cent. MgO, 42 to 64 per cent. Cr₂O₃, 0 to 13 per cent. Al₂O₃, and 0 to 11 per cent. SiO₂. Calcium, manganese, and nickel are also occasionally present.

Of the finely-powdered and bolted mineral, 0.5 gm. is fused in an inclined, open platinum crucible with 4 gms. of pure sodium carbonate * for two hours over a good Teclu burner. After cooling, the melt is leached with water, acidified with hydrochloric acid, † evaporated in a porcelain dish until a dry powder is obtained, moistened with hydrochloric acid, taken up in water, and the silica filtered off. The latter is ignited, weighed, and its purity tested with hydrofluoric acid (p. 487). The filtrate from the silicic acid is precipitated hot with hydrogen sulphide and the precipitate of platinum sulphide and sulphur is filtered off. It is then placed in an Erlenmeyer flask, 10 c.c. of ammonium chloride, enough ammonia (free from carbonate) to make the solution alkaline, and a little freshly-prepared ammonium sulphide are added, after which the flask is corked up and allowed to stand over night. In the morning the precipitate is filtered off, washed twice with water containing a little ammonium sulphide, then dissolved in hydrochloric acid, and the precipitation by means of ammonium sulphide is repeated. The ammonium salts are removed from the filtrate and the calcium and magnesium determined as described on p. 76-8.

The ammonium sulphide precipitate is dissolved in dilute hydrochloric acid, any residue of nickel or cobalt sulphide is fil-

* Bunsen fused the chromite with one-third as much SiO₂ and 6 to 8 parts Na₂CO₃ and then subtracted the amount of silica added from the total amount found. This makes the decomposition take place more readily, but the author prefers not to add the silica on account of the possibility of thereby introducing an error.

† If a dark residue of undecomposed mineral should remain, it is filtered off and again fused with sodium carbonate.

tered off and dried. This residue is then ignited first in air, then in a current of hydrogen, and finally weighed as metal. It is not worth while to attempt the separation of the nickel from the cobalt on account of the small amount present. The filtrate from the sulphides of nickel and cobalt is freed from hydrogen sulphide by boiling, the iron present is oxidized by evaporating with potassium chlorate and hydrochloric acid, and the iron, chromium, and aluminium are separated from the manganese by means of the barium carbonate method (p. 149) and from one another as described on p. 167 et seq. In the filtrate from the barium carbonate precipitate, the manganese is separated from the barium as described on p. 122, *b*, and determined as sulphide or as sulphate.

Remark.—If it is desired to determine the chromium alone, this is best accomplished by means of a volumetric process (see Part II).

Determination of Thorium in Monazite, according to E. Benz.*

Monazite is a phosphate of the rare earths [$\text{PO}_4(\text{Ce}, \text{La}, \text{Di}, \text{Th})$]. It occurs in so-called "monazite sand" mixed with quartz, rutile, zircon, tantalates, etc., and is at present the raw material used for the preparation of thorium (used in the Welsbach mantle). The value of a sample of monazite sand depends upon the amount of thorium present, and its determination is best effected as follows:

Of the bolted monazite sand, 0.5 gm. is intimately mixed with 10 gms. of potassium pyrosulphate in a spacious platinum crucible; the latter is covered and slowly heated until its contents are at a gentle fusion. This is best accomplished by placing the platinum crucible within a larger porcelain one which is provided with an asbestos ring. After no more gas is given off, the crucible is gently ignited over the free flame, and, after cooling, its contents are treated with water and a little hydrochloric acid until it is completely disintegrated. After allowing the residue to settle, it is filtered, treated with a little concentrated hydrochloric acid, diluted with water, and again filtered.† In the com-

* Zeit. f. angew. Chem. 15 (1902), p. 297.

† This residue is free from thorium, and consists chiefly of silicic and tantalic acids.

bined filtrates the hydrochloric acid is nearly neutralized with ammonia (the formation of a permanent precipitate is to be avoided, for it will be difficult to redissolve it), the solution is heated to boiling, and 3 to 5 gms. of solid ammonium oxalate are added while the liquid is vigorously stirred. The oxalates of the rare earths are immediately deposited in the form of a coarse powder. To make sure that the precipitation is complete, a little ammonium oxalate solution is added. After standing twelve hours the precipitated oxalates are filtered off, washed once by means of water acidified with nitric acid, then transferred to a porcelain dish, and the last portions of the precipitate are eventually washed from the filter by repeated additions of hot, concentrated nitric acid and water; the liquid is evaporated almost to dryness. Ten cubic centimeters of concentrated nitric acid (sp. gr. 1.4) and 20 c.c. of fuming nitric acid are then added, the dish covered with a watch-glass and heated on the water-bath. After a short time the nitric acid begins to decompose the oxalic acid, shown by the lively evolution of gas. After no more gas is given off, the watch-glass and sides of the dish are washed down and the solution evaporated to dryness. In order to remove the free nitric acid, a little water is added and the solution evaporated once more; after this the filter fibres present are removed by filtration. It is now necessary to separate the thorium from the remaining earths. This is effected by precipitating the former with hydrogen peroxide as thorium peroxide. On ignition the latter is changed into ThO_2 , in which form it is weighed.

The precipitation with hydrogen peroxide takes place as follows: The neutral solution of the nitrates is diluted with 10 per cent. ammonium nitrate solution to a volume of 100 c.c., heated to 60–80° C., and precipitated by the addition of 20 c.c. of pure 3 per cent. hydrogen peroxide solution. The precipitate, which is colored yellow by traces of cerium peroxide (at the most $\frac{3}{10}$ mg. of the latter is present), is immediately filtered, washed with hot water containing ammonium nitrate, ignited wet in a platinum crucible, and weighed as ThO_2 .

If it is desired to obtain an absolutely pure thorium oxide, the moist precipitate is dissolved in nitric acid and the above precipitation with hydrogen peroxide is repeated. By this method

E. Benz obtained in the analysis of a South American monazite sand the following results: 4.72, 4.58, 4.50 per cent. ThO_2 .

Remark.—The above process for the determination of thorium in monazite is quicker and more accurate than either that of Glaser * or that of Hintz and Weber, † so that it is to be recommended for both technical and scientific purposes.

The determination of thorium oxide in thorite is carried out in the same way with the difference that instead of fusing the mineral with sodium fluoride and potassium pyrosulphate, it is decomposed by treatment with hydrochloric acid, and the silica removed as usual. The filtrate from the silica is analyzed as above. ‡

For the

Analysis of Incandescent Mantles

consult the work of T. B. Stillman, *Chem. Zeit.*, 1906, 60.

Determination of Water in Silicates.

If the mineral on ignition loses nothing but water, the amount of the latter can be determined by the loss in weight. In the great majority of cases, however, other constituents (e.g. CO_2 , SO_2 , Cl, F, etc.) are lost and the substance may undergo an oxidation (FeO is changed to Fe_2O_3 , PbS to PbSO_4 , etc.). In such cases the procedure recommended by Jannasch can be used to advantage. The substance is heated with lead oxide, the water vapor conducted over a heated mixture of lead oxide and lead peroxide and absorbed in a weighed calcium chloride tube (see p. 484).

If the substance on ignition loses simply water and carbon dioxide the former may be accurately determined by the method of Brush and Penfield. § The substance is introduced by means

* *Chem. Ztg.*, 1896, p. 612.

† *Zeitschr. für anal. Chemie* (1897), XXXVI, p. 27.

‡ As members of the hydrogen sulphide group are usually present, it is advisable to first remove them and to effect the precipitation of the rare earths with ammonium oxalate from the slightly acid filtrate from the hydrogen sulphide precipitate.

§ *Amer. Journ. Sci.* [3], XLVIII (1894), p. 31, and *Zeit. für anorg. Chem.*, VII (1894), p. 22.

of a long funnel into a bulb blown on the end of a narrow tube made of difficultly-fusible glass, and the tube is provided with a second bulb about 2 or 3 cm. from the end one. The open end of the tube is connected by means of a short piece of rubber tubing with a short tube drawn out into a capillary, and the substance is heated in the flame of a good Teclu burner. The water is expelled and condenses in the colder portion of the tube, and as a precaution the latter is enveloped in moist blotting-paper. As soon as no more water can be expelled, the end of the tube is heated until it softens and the tube is drawn out between the two bulbs. The front end of the tube now contains the water in the presence of a little carbon dioxide, and the latter must be removed. For this purpose the tube is inclined at an angle of 40° , so that the heavier carbon dioxide will run out of it. The weight of the tube slowly diminishes, but at the end of about three hours it becomes constant, losing about 0.0003 gm. per hour, due to the evaporation of water. If, therefore, the tube is allowed to stand three hours before weighing, 0.0009 gm. must be added to the weight of the water. If the substance contained a large amount of carbonate, the escaping carbon dioxide will carry aqueous vapor with it, so that a further correction must be made. One gram of CO_2 at an average barometric pressure (760 mm.) and temperature (20°C.) will cause a loss of 0.0096 gm. water vapor. If the amount of carbon dioxide present is known, it is, therefore, only necessary to multiply its weight by 0.0096 to obtain the amount of water that would otherwise escape the determination.

Determination of Silicon.

See Steel Analysis, p. 441.

Determination of Silicon in the Presence of Silicic Acid.

Gf. M. Phillips, *Z. angew. Chem.*, **14**, 1969 (1905).

PART II.

VOLUMETRIC ANALYSIS.

A GRAVIMETRIC analysis is accomplished by adding to the solution of the substance to be analyzed a reagent of only approximately-known strength, separating one of the products of the reaction from the solution and weighing it. On the other hand, a volumetric analysis is made by causing the reaction to take place by means of a measured amount of a solution of accurately-known strength and computing the amount of substance present by the volume of the solution which reacts with it (cf. p. 2). For the latter sort of analysis accurately-calibrated measuring instruments are necessary, as will be briefly described.

Measuring Instruments.

1. *Burettes* are tubes of uniform bore through the whole length; they are divided into cubic centimeters and are closed at the bottom, as shown in Fig. 82, by means of a glass stop-cock, or with a piece of rubber tubing containing a glass bead *h*. The latter form was devised by Bunsen and is used as follows: The tubing is seized between the thumb and forefinger at the place where the glass bead is, and by means of a gentle pressure a canal is formed at one side of the bead through which the liquid will run out. Instead of the glass bead an ordinary pinch-cock is frequently used.

Besides the above forms of burettes, a great many others are in use, but it is unnecessary to describe them here.

2. *Pipettes*.—A distinction must be made between a "full" pipette and a "measuring" one. A *full pipette* has only one

mark upon it, and serves for measuring off a definite amount of liquid. They are constructed in different forms; usually they consist of a glass tube with a cylindrical widening at the middle. The lower end is drawn out, leaving an opening about $\frac{1}{2}$ -1 mm.

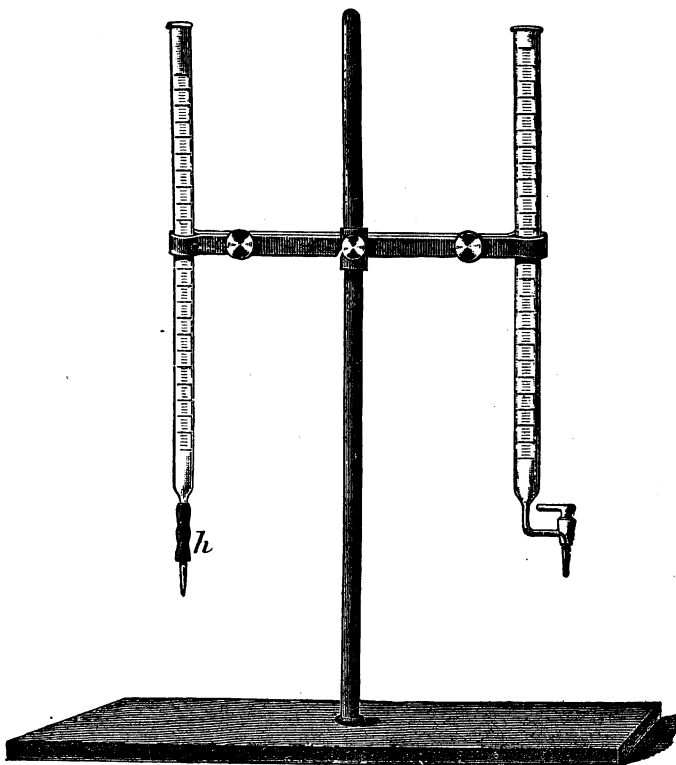

FIG. 82.

wide. Pipettes of this nature are constructed which will hold respectively 1, 2, 5, 10, 20, 25, 50, 100, and 200 c.c.

Measuring pipettes are burette-shaped tubes graduated into cubic centimeters and drawn out at the lower end as before. They serve to measure out any desired amount of liquid and are obtained with a total capacity of 1, 2, 5, 10, 20, 25, and 50 c.c.

3. *Measuring-flasks* are flat-bottomed flasks with narrow necks provided with a mark, so that when they are filled to this

point they will contain respectively 50, 100, 200, 250, 300, 500, 1000, and 2000 c.c. They serve for the preparation of standard solutions and for the dilution of liquids to a definite volume.

4. *Measuring-cylinders* are graduated into cubic centimeters and are used only for rough measurements.

It is clear that accurate results can be obtained by a volumetric analysis only when the instruments used are accurately calibrated. It should never be taken for granted that a purchased instrument is correct, but it should always be carefully tested. In the case of measuring-flasks and "full" pipettes, it is best for each one to etch for himself the position on the flask or tube up to which they should be filled with liquid.

Normal Volume and Normal Temperature.

A liter, which is the volume of a kilogram of water at its maximum density, is taken as the normal volume. If it is desired to mark on the neck of a liter-flask the point to which this volume reaches, the position of the mark depends upon the temperature of the vessel. It is necessary, therefore, to choose for the vessel itself a definite temperature, the so-called *normal temperature*. At present the temperature of $+15^{\circ}$ C. is almost universally taken as the normal temperature. According to this, then, the flask should be marked at 15° with the volume occupied by a kilogram of water at $+4^{\circ}$, and as the kilogram is the unit of mass, the weighing should also take place in a vacuum.

This experimental impossibility can be avoided inasmuch as the weight of a liter of water is known accurately at temperatures other than $+4^{\circ}$, also the expansion of the glass with rise of temperature, and the buoyancy which the weights and the water experience as a result of weighing in the atmosphere. The weights which must be placed upon the balance pan in order to determine the space occupied by a true liter of water, therefore, depend upon the temperature of the water and of the vessel, as well as the density of the air at the time of the experiment. The density of the air varies somewhat from day to day and depends upon the barometric pressure, the temperature, and the amount of moisture.

It suffices in most cases, however, to assume the average values of these factors corresponding to the locality.

As regards the density of water at different temperatures, this is given in the following table:

DENSITY OF WATER AT DIFFERENT TEMPERATURES *

<i>t</i>	Density.	<i>t</i>	Density	<i>t</i>	Density.
0°	0.999867	14°	0.999271	28°	0.996258
1	9926	15	9126	29	0.995969
2	9968	16	8969	30	5672
3	9992	17	8801	31	5366
4	1.000000	18	8621	32	5052
5	0.999992	19	8430	33	0.994728
6	9968	20	8220	34	4397
7	9920	21	8017	35	4058
8	9876	22	0.997795	36	0.993711
9	9808	23	7563	37	3356
10	9727	24	7321	38	0.992993
11	9632	25	7069	39	2622
12	9524	26	0.996808	40	0.992244
13	9404	27	6538		

* Thiesen, Scheel and Diesselhorst, 1904.

With the aid of this table it is possible to tell what the weight of a liter of water will be at any temperature. It was stated on page 13 that if p_0 is the weight of a body in a vacuum and p that of the same body in the air, then

$$p_0 = p \left(1 + \frac{\lambda}{s} - \frac{\lambda}{s_1} \right),$$

in which expression λ denotes the density of the air under the prevailing conditions, s that of the body and s_1 that of the brass weights at t° .

At t° , however, the volume occupied by the mass compared with that at 15° is

$$V_t = V_{15} [1 + \alpha(t - 15)]$$

where α is the coefficient of cubical expansion. The weight of

water contained in the mass at t° in a vacuum (disregarding quantities of the second order) is:

$$p = \frac{V_{15}[1 + \alpha(t - 15)] \cdot s}{1 + \lambda \left(\frac{1}{s} - \frac{1}{s_1} \right)}$$

If, therefore, it is desired to determine the volume of a liter by weighing water at 17.35° with brass weights, the computation is carried out as follows:

The density of water at 17.35° is given by interpolation in the above table as $0.9987 = s$, the density of the brass weights can be taken as $8.0 = s_1$, the density of the air as 0.001214 and the coefficient of cubical expansion of glass as 0.000027 , so that by inserting these values in the above equation:

$$p = \frac{0.9987[1 + 0.000027(17.35 - 15)]}{1 + \frac{0.001214}{0.9987} - \frac{0.001214}{8.0}} = 0.9977 \text{ kg.},$$

or in other words the volume occupied by 997.7 gms. of water under the above conditions represents one liter in glass at 15° .

Invariably the temperature of the laboratory is such that somewhat less than 1000 gms. is used for the calibration in true cubic centimeters. It is convenient, therefore, to place the 1000-gm. weight on one side of the balance together with the empty flask, and then place a tare on the opposite side of the balance. Then the 1000-gm. weight is removed and in its place $1000 - p$ gms. are placed, after which equilibrium is restored by filling the flask with water.

To avoid the somewhat tedious calculation of the value of p , W. Schlösser* has calculated the following table in which the values are given for $1000 - p$ at different temperatures.

* Z. angew. Chem., 1903, 960; Chem. Ztg., 1904, 4.

Correction Table.

This table shows in milligrams how much less than 1000 gm. is the weight of water which occupies a volume of one liter, on the assumption that the coefficient of cubical expansion for the glass is 0.000,027 per degree Centigrade, the normal temperature is 15°, the barometric pressure 760 mm. the temperature of the air 15°, and the tension of aqueous vapor is normal. The table reads from a temperature of 5.0° to one of 30.9°.

<i>t</i>	0.0	0.1	0.2	0.3	0.4	0.5	0.6	0.7	0.8	0.9
5°	1341	1340	1339	1338	1338	1338	1338	1338	1338	1338
6	1338	1339	1340	1341	1342	1343	1344	1345	1346	1348
7	1350	1352	1354	1356	1358	1360	1363	1366	1369	1372
8	1376	1380	1384	1388	1392	1396	1400	1404	1408	1412
9	1417	1421	1426	1431	1436	1442	1447	1452	1458	1464
10	1471	1477	1483	1489	1496	1503	1510	1517	1524	1531
11	1539	1547	1555	1563	1571	1579	1587	1595	1603	1611
12	1619	1628	1637	1646	1655	1664	1673	1683	1693	1703
13	1713	1723	1733	1743	1753	1764	1775	1786	1797	1808
14	1819	1830	1841	1853	1865	1877	1889	1901	1913	1925
15	1937	1949	1962	1975	1988	2001	2014	2027	2040	2053
16	2066	2080	2094	2108	2122	2136	2150	2164	2178	2193
17	2208	2223	2238	2253	2268	2283	2298	2313	2328	2344
18	2360	2376	2392	2408	2424	2440	2457	2474	2491	2508
19	2525	2542	2559	2576	2593	2610	2627	2645	2663	2681
20	2699	2717	2735	2753	2771	2789	2807	2826	2845	2864
21	2883	2902	2921	2940	2959	2978	2998	3018	3038	3058
22	3078	3098	3118	3138	3158	3178	3199	3220	3241	3262
23	3283	3304	3325	3346	3367	3388	3410	3432	3454	3476
24	3498	3520	3542	3564	3586	3609	3632	3655	3678	3701
25	3724	3747	3770	3793	3816	3839	3862	3886	3910	3934
26	3958	3982	4006	4030	4054	4078	4102	4127	4152	4177
27	4202	4227	4252	4277	4302	4327	4352	4377	4403	4429
28	4455	4481	4507	4533	4559	4585	4611	4637	4663	4689
29	4716	4743	4770	4797	4824	4851	4878	4905	4932	4959
30	4987	5014	5041	5069	5097	5125	5153	5181	5210	5239

If it be desired to take into consideration the deviation of the temperature and barometric pressure from that assumed in the above table, it is sufficient to add (or subtract) to the figure given

in the table 1.4 mgm. for each millimeter that the barometer reads above (or below) 760 mm., and to subtract (or add) 4 mgm. for each degree that the temperature of the air is above (or below) 15° C.

If, for example, the temperature of the water is 17.35°, the barometer reading 720 mm., and the temperature of the air 23.7°, then the correction is computed as follows:

According to the table the value of $1000-p$ is 2260 mgm., this number, therefore should be diminished by

$$(760 - 720)1.4 = 56 \text{ mgm.}$$

$$(23.7 - 15)0.4 = \frac{35}{91} \text{ mgm.}$$

The correction becomes $2260 - 91 = 2169$ mgm. = 2.169 gms. In order to simplify the matter still further, Schlösser recommends preparing a special table for localities where the average barometric pressure is considerably less than 760 mm. Thus the following table applies to Zürich and can be used for other places where the average barometric pressure is correspondingly low.

CORRECTION IN GRAMS FOR 1000 C.C.

under the assumption that the coefficient of cubical expansion for glass is 0.000027 per degree Centigrade, the normal temperature of glass is 15°, the temperature of the water between 5° and 30.5°, the barometer reading 720 mm., the temperature of the air 15° and the vapor tension normal.

t	Correction in Grams.	t	Correction in Grams.	t	Correction in Grams.	t	Correction in Grams.
5.0°	1.284	11.5°	1.522	18.0°	2.303	24.5°	3.552
5.5	1.281	12.0	1.562	18.5	2.383	25.0	3.667
6.0	1.281	12.5	1.607	19.0	2.468	25.5	3.782
6.5	1.286	13.0	1.656	19.5	2.553	26.0	3.901
7.0	1.293	13.5	1.707	20.0	2.642	26.5	4.021
7.5	1.303	14.0	1.762	20.5	2.732	27.0	4.145
8.0	1.319	14.5	1.820	21.0	2.826	27.5	4.270
8.5	1.339	15.0	1.880	21.5	2.921	28.0	4.398
9.0	1.360	15.5	1.944	22.0	3.021	28.5	4.528
9.5	1.385	16.0	2.009	22.5	3.121	29.0	4.659
10.0	1.414	16.5	2.079	23.0	3.226	29.5	4.794
10.5	1.446	17.0	2.151	23.5	3.331	30.0	4.930
11.0	1.482	17.5	2.226	24.0	3.441	30.5	5.068

To calibrate a 500 c.c. flask for the normal temperature of the glass at 15° by means of water at 19.5° at Zürich, the correction is taken from the above table and divided by 2, $\frac{2.553}{2} = 1.276$ gms.

In most cases it is not necessary to take into consideration slight changes in the barometer reading or in the temperature of the air.

The Mohr Liter.

Before the above tables had been worked out by Schlösser it was customary to avoid the computation otherwise necessary by adopting a standard other than that of the true liter, and the practice is still adhered to by many chemists. Thus for volumetric work the liter was taken as the volume of a kilogram of water at either 15° or 17.5° C. as weighed in the air. For all titrations this standard is perfectly satisfactory, but it is not suitable for the measurement of the volume of gases in which it is necessary to estimate the weight of a gas from the volume, because the density of gases is always referred to true liters.

A Mohr liter measured with water at 15° is 1.0019 and one measured with water at 17.5° is 1.0023 times the volume of a true liter. In other words the former is 1.9 cm. and the latter 2.3 cm. too large.

When in the course of this book a liter is mentioned, the true liter is to be understood in all cases.

Since, however, many instruments are still graduated at normal temperatures of 15°, 17.5° and 20°, a table will be given (see p. 522) which can be used for testing such apparatus.*

Thus, to determine the volume of a Mohr liter for the normal temperature of 15°, the liter flask and 1 kg. in brass weights should be counterpoised against a tare. The kilogram weight is then removed, the flask is filled with water at 15° and the

* Most burettes are calibrated by the maker on the assumption that 1 c.c. is the volume occupied by 1 gram of water at 15°. It really makes no difference which unit is used provided all the measuring instruments used in an analysis, including the standardization of solution, are calibrated with the same unit. The need of testing every calibrated instrument cannot be emphasized too strongly. Recently many of the measuring instruments manufactured under war conditions were badly calibrated.

position of the meniscus in the neck of the flask is marked. If, however, the temperature of the water is not 15°, but say 25.5°, then evidently the Mohr liter will weigh, according to the following table, 998.095 gms.

TABLE FOR PREPARING A MOHR LITER AT THE NORMAL TEMPERATURES OF 15, 17.5 AND 20° C. ACCORDING TO W. SCHLÖSSER.

Temperature of Water.	Normal Temperatures.		
	15°	17.5°	20°
	Grams.	Grams.	Grams.
15°	1000.000	1000.345	1000.763
16	999.871	.217	.634
17	.728	.075	.491
18	.576	999.023	.339
19	.413	.760	.175
20	.237	.584	1000.000
21	.053	.400	999.816
22	998.858	.204	.620
23	.652	998.999	.414
24	.437	.783	.199
25	.212	.558	998.973
26	997.977	.323	.739
27	.733	.078	.494
28	.479	997.825	.240
29	.218	.563	997.978
30	996.946	.292	.707

Calibration of Measuring-flasks.

A flask is chosen with a long neck, as cylindrical as possible, the diameter of which should not exceed a certain value.

GREATEST PERMISSIBLE DIAMETER OF THE NECK

Contents	2000	1000	500	250	200	100	50	25 c.c.
Diameter	25	18	15	15	12	12	10	6 mm.

The flask is very carefully cleansed, and dried, after which it is placed upon an accurate balance and counterpoised by a tare. Beside the tare weights are placed corresponding to the volume of the flask, and on the opposite side of the balance weights corresponding to the correction obtained from the table on page 519 corresponding to the temperature of the water to be used, after which equilibrium is again established by pouring distilled water into the flask. Care is taken that no drops of water are left suspended from the sides of the neck above the water-level; if any

are present, they are removed by touching with a piece of filter-paper wrapped around the end of a glass rod. An exact equilibrium is finally established by adding or removing a little water by means of a capillary tube. The flask is then placed upon a level surface and a piece of gummed paper with a straight edge is fastened around the neck of the flask so that its upper edge is just tangent to the deepest point of the water meniscus. The flask is now emptied, dried, its neck covered with a uniform layer of bees-wax, and allowed to cool; this usually requires about fifteen minutes. The flask is then held, as is shown in Fig. 83, against the piece of wood *s*, the blade of a pocket-knife is placed firmly against the upper edge of the thick paper ring, and the flask is revolved through 360° around its horizontal axis; in this way a circle is cut in the wax layer. By means of a feather (Fig. 6, p. 22) a drop of hydrofluoric acid is placed along this circle while the flask is held in the horizontal position. By turning the flask around its axis, the drop of hydrofluoric acid is allowed to act upon the glass where the wax coating has been cut. At the end of two minutes the excess of hydrofluoric acid is washed off, the neck of the flask dried by means of filter-paper and heated until the wax melts, when the latter can be readily wiped off. The last traces of wax are removed by rubbing with a cloth wet with alcohol. As it is possible that the etched circle will not exactly coincide with the upper edge of the paper, the flask should always be tested.

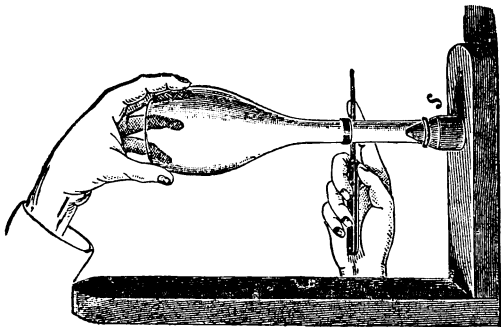

FIG. 83.

* The attempt should not be made to test the correctness of the calibration by filling the flask with water which has been brought to a definite temperature; it is important, on the other hand, that the flask and water should be allowed to remain for some time in the same place in order that the temperature of the two may be nearly the same.

Testing Calibrated Flasks.

The flask is counterbalanced with a tare and then weights are added to the tare corresponding to the volume of the flask. The flask is filled with distilled water up to the mark and equilibrium is restored by adding small weights.

Thus in testing the calibration of a liter flask, it was filled three times with water at 21.5° after it had been counterbalanced with a tare when perfectly dry. It was found necessary to place small weights on the side with the filled flask amounting to 2.987, 2.893 and 3.122 gms.; average 3.001 gms. If the flask had been perfectly accurate it is found from the table on page 520 that the small weights should have been equal to 2.921 gms. for water at 21.5°. The flask is, therefore, $3.001 - 2.921 = 0.080$ gm. too small.

This is, however, an unusually good agreement. According to the Royal Commission of Berlin, the allowable error in calibrated flasks is shown by the following table:

PERMISSIBLE ERROR FOR FLASKS CALIBRATED FOR CONTENTS

(The allowable error for flasks calibrated for delivery is twice as large.)

Contents . .	2000	1000	500	400	300	250	200	100	50 c.c.
Error	0.5	0.25	0.14	0.11	0.11	0.08	0.08	0.08	0.05 c.c.

Liter flasks which are calibrated for contents are marked in Germany 1 l. $\frac{15^\circ}{4^\circ}$ (E) in case they are calibrated in terms of true cubic centimeters, and 1 l. $\frac{15^\circ}{15^\circ}$ (E),* in case they are calibrated in Mohr liters. Flasks calibrated for delivery are marked with an A instead of the E.

Calibration of Pipettes.

It is best to have pipettes prepared by the glass-blower and to etch them for one's self. First of all, the pipette must be scrupulously clean; no trace of fat should be left on the inner sides of the tube, for it will cause drops of moisture to adhere and escape

* Or $\frac{17.5^\circ}{17.5}$ (E), or $\frac{20^\circ}{20^\circ}$ E, according to the normal temperature chosen.

measurement. The pipette is, therefore, cleaned by placing it in a tall beaker containing a little soap solution and the latter is drawn to the top of the pipette by sucking through a rubber tube fastened to its upper end and which is provided with a pinch-cock. The solution is allowed to remain in the pipette for about fifteen minutes.

The alkali is then allowed to run out, the pipette washed with water and filled with a warm solution of chromic acid in concentrated sulphuric acid.* This is allowed to remain from five to ten minutes in the pipette and is then removed, the tube washed first with water from the tap and finally with distilled water.

The pipette is now clean and ready to be calibrated. A long strip of paper is fastened upon the upper part of the tube, the lower end is closed with the finger, and the pipette is filled with water which has stood for some time in the balance room, from another of the same size or from a burette. The position of the bottom of the meniscus is noted with a lead-pencil upon the paper which was fastened to the side of the pipette. Assume, for example, that it is desired to calibrate a 10-c.c. pipette, and that the water to be used is at a temperature of 18°. According to the table on p. 480 one liter of water at 18° weighs in the air exactly $1000 - 2.303 = 997.70$ gms., consequently 10 c.c. should weigh 9.9770 gms.

The point of the pipette is dipped in water, and this is sucked up into the pipette by placing the mouth at the upper end until the water is above the pencil marking. The top of the pipette is then closed with the finger, the water adhering to the outside carefully wiped off, and that inside is allowed to run into a beaker, with the point of the pipette against the walls, until the upper meniscus in the stem is exactly on the mark. The contents of the pipette are then allowed to run into a tared beaker which is covered with a watch glass, or into a glass-stoppered weighing-beaker, allowing the water to flow along the walls of the beaker. Now on weighing the beaker again it is perhaps found that the gain

* A solution of potassium dichromate in concentrated sulphuric acid can be used.

in weight is 9.9257 gms. or $9.9770 - 9.9257 = 0.0513$ gms. too little. A second mark is therefore made a little higher up on the paper attached to the stem of the pipette, and the above process is repeated. If necessary a third mark is made until finally the weight of the water does not vary more than 5 mgms. from that computed.

The strip of paper is then cut off at exactly the correct mark, a strip of gummed paper is placed round the pipette at this point, and, after the gum has dried, it is covered with a layer of beeswax and etched with hydrofluoric acid as described on p. 523. After the mark has been etched upon the pipette, it is filled with water up to the mark and emptied into the tared flask. This operation is repeated three times and the mean value is taken as correct.

Pipettes may be emptied in several ways:

1. By allowing the contents to run out freely with the pipette held vertically. At the end the end of the pipette is touched to the sides of the beaker. A drop of the liquid will then always remain in the pipette.

2. The solution is allowed to run out while the point of the pipette is held against the side of the vessel into which the liquid is being delivered.

All other methods of emptying pipettes, especially that of blowing at the last, are to be abandoned. At all events, it is *always necessary to use the pipette in the same way as in the calibration.*

The "kaiserl. Normaleichungskommision" allows the following error in pipettes.

Contents of pipette .	100	50	25	20	10	2	1	c.c.
Error in c.c.	0.07	0.05	0.025	0.025	0.02	0.006	0.006	
Error in per cent....	0.07	0.1	0.10	0.125	0.2	0.3	0.6	

It is possible, however, to prepare pipettes which are more accurate than this; thus the author by using pipettes as recommended above obtained the following values:

50 c.c. Pipette: 49.9904, 49.9910, 49.9926.	Mean 49.9913.
$f^* = 0.002\%$, $F = 0.001\%$.	
20 c.c. Pipette: 20.0059, 20.0068, 20.0055.	Mean 20.0061.
$f = 0.003\%$, $F = 0.002\%$,	

and in the same way:

10 c.c. Pipette:	$f = 0.008\%$, $F = 0.004$.
5 c.c. Pipette:	$f = 0.011$, $F = 0.006\%$.

Calibration of Burettes.

In volumetric titrations it is advisable to begin each titration with the solution at the zero point of the burette. It is proper, therefore, to calibrate burettes in the same way. The burette is filled to the zero point and a definite volume, e.g., 5 c.c., is allowed to run into a tared beaker, as described for pipettes on p. 525, allowing the tip of the burette to touch the side of the beaker. After determining the weight of the water, the burette is filled again to the zero point and then 10 c.c. are withdrawn in exactly the same way. This process is repeated for each 5 c.c. until finally the 50 c.c. mark is reached, each time determining the weight of the water withdrawn. In withdrawing liquid from a burette until a given point is reached, without waiting for the burette to drain, evidently the amount actually withdrawn depends upon the rate at which it flows from the burette. It is advisable, therefore, to have the tip so narrow that it will take 80 seconds for 50 c.c. to run out. It is true that the burette is not

* By f is understood the average error of the single determination. It is computed by the formula $f = \pm \sqrt{\frac{\Sigma(d^2 + d_1^2 + d_2^2 + \dots)}{n-1}}$ (cf. Kohlrausch:

Leitfaden der prakt. Physik.), in which n represents the number of determinations made, and $d, d_1, d_2 \dots$ represent the deviation of each from the arithmetical mean and $\Sigma (d^2 + d_1^2 + d_2^2 + \dots)$ the sum of the squares of

the errors. $F = \pm \sqrt{\frac{\Sigma(d^2 + d_1^2 + d_2^2 + \dots)}{n(n-1)}}$ and represents the probable error of the mean.

drained completely in this time,* but according to Wagner † it is sufficiently so for practical purposes.

Burettes with rubber tubing at the bottom gradually change with regard to the amount delivered on account of the rubber losing its elasticity. For this reason the tubing should be made quite short and when it begins to get old it should be renewed.

The corrections obtained as above are best tabulated by means of a plot in which the burette readings are taken as abscissæ and the corrections as ordinates. By connecting the points, a curve is obtained by means of which the correct reading of all parts of the burette can be obtained at a glance.

Method of Reading Burettes.

Although in the case of graduated flasks and pipettes the marks are carried around the whole circumference of the tube, in the case of burettes this is not usually done, ‡ so that it is a matter of some difficulty to determine with certainty the exact position of the lowest part of the meniscus. To avoid a parallax error a number of means have been devised. Thus floats are often used such as are shown in Fig. 84, *a* and *b*; the former represents that of Beuttel and the latter that of Rey.

FIG. 84.

Around the bulb of *a* a circle is etched, and if the eye is in the correct position, it appears to the observer as a straight line. The liquid in the burette is at the zero-mark, when the projection line from the circle on the float exactly coincides with the line at the zero-point on the burette. In the case of dark-colored liquids it is difficult to see the circle in the case of the float *a*, but this difficulty is overcome in *b* by the circle being etched upon the upper bulb (in the figure the latter is drawn too small). Such floats are weighted so that the upper bulb rises above the level of the liquid in the burette; it is, therefore, easier to make a reading with the float devised by Rey than with that of Beuttel. In refilling the burette, the former float assumes an inclined position; it must, therefore,

* W. Schlösser, *Chem. Ztg.*, 1904, 4.

† Habilitationsschrift, Leipzig, 1898.

‡ Such burettes can be purchased, however, and very accurate readings can be made with them.

be removed, dried off, and again carefully introduced into the liquid.*

Schellbach has invented another method of avoiding the parallax error, by providing the back of the burette with a dark vertical

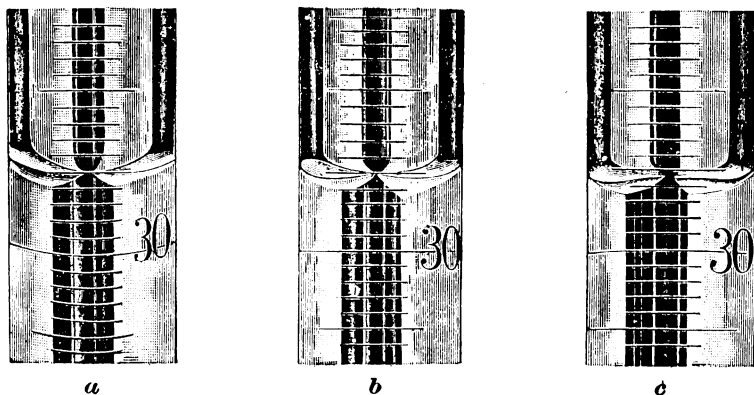

FIG. 85

line upon a background of milky glass as is shown in Fig. 85. When the eye is in the correct position, this dark line is apparently drawn out into two points as shown in *b*, whereas if the eye is too low the appearance *a* is obtained, or *c* if the eye is too high.

Kreitling † has proved, however, that the use of floats is likely to lead to error, and experiments have also shown that the Schellbach burettes are not altogether reliable. Better than these is the Bergmann's screen as improved by Göckel.‡ If burettes

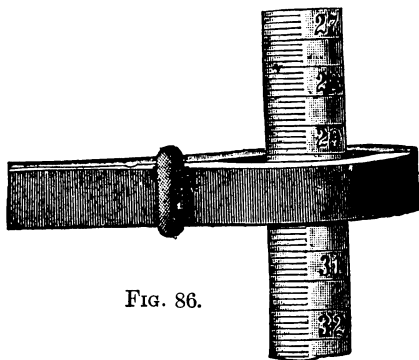

FIG. 86.

* This difficulty is overcome by Diethelm by placing below the large bulb a second "flattened-out" bulb, and in this case the float will not attach itself to the sides of the burette, so that it is not necessary to remove it in refilling the burette.

† Z. angew. Chem., 1900, 829, 990; 1902, 4.

‡ Chem. Ztg., 1901, 1084. Z. angew. Chem., 1898, 1856.

are used on which the divisions extend at least half around the tube, and the eye is placed so that the line on the back of the burette coincides with that on the front, then with the use of this screen very exact results are obtained.

Bergmann's screen, which can be used to advantage with all kinds of vessel, consists of a wooden test-tube holder painted a dull black (Fig. 86). The reading is made easier if a piece of ground glass or a strip of oiled paper is held behind the burette, or fastened to the screen itself.

The "kaiserl. Normalaichungskommission" gives as the

ALLOWABLE ERROR FOR BURETTES.

Contents	100	75	50	30	10	2 c.c.
	0.08	0.06	0.04	0.03	0.02	0.008 c.c.

Normal Solutions.

By a *normal solution* is understood one which contains one "gram-equivalent" of the active reagent dissolved in one liter of solution.* By "gram-equivalent" is meant the amount of substance corresponding to one gram-atom (1.008 gms.) of hydrogen. For convenience in computation the concentration of solutions used for volumetric purposes are expressed in terms of their normality; i.e., a solution is 2 normal, $\frac{1}{2}$ normal, $\frac{1}{10}$ normal, etc. The letter N is used as an abbreviation for *normal*.

The gram equivalent, or weight required to make a liter of normal solution, depends upon the nature of the reaction involved. It often happens that the same solution has a certain normal concentration when used for one purpose and a different normal concentration when used for another purpose. The reagents used in volumetric analysis are acids, bases, oxidizing agents, reducing agents and precipitants.

The equivalent weight of an acid is determined by the number of replaceable hydrogen atoms in the acid molecule. Thus, to make a normal solution of the monobasic hydrochloric, hydrobromic, hydriodic, nitric or acetic acids, it is necessary to have a

* It is important to note that a normal solution is not properly defined as one containing a gram equivalent in 1 liter of *solvent*. In volumetric analysis the unit is always referred to the volume of the solution.

molecular weight in grams of the acid dissolved in a liter of solution. A molecular weight in grams is often called one *mole* (cf. Vol. I).

Sometimes, however, it is not convenient to react with all the replaceable hydrogen atoms of an acid. In fact some acids are so weak that they cannot be used in volumetric analysis. Carbonic acid, for example, has no appreciable effect upon methyl orange and only one of the two hydrogen atoms in H_2CO_3 is acid toward phenolphthalein.

Phosphoric acid, H_3PO_4 , really has three replaceable hydrogens but only the first is acid toward methyl orange and two hydrogen atoms are acid toward phenolphthalein. In titrating with methyl orange, phosphoric acid acts as a monobasic acid and the normal solution contains one mole per liter. With phenolphthalein as an indicator, phosphoric acid acts as a dibasic acid and one-half mole per liter will make a normal solution of phosphoric acid.

A normal solution of a base will contain one mole of replaceable hydroxyl. Thus of potassium hydroxide, KOH , sodium hydroxide, NaOH , and ammonium hydroxide, NH_4OH , one mole per liter makes a normal solution. Of barium hydroxide, $\text{Ba}(\text{OH})_2$, calcium hydroxide, $\text{Sr}(\text{OH})_2$ and strontium hydroxide, $\text{Sr}(\text{OH})_2$ only one-half mole is required. Magnesium hydroxide is not appreciably soluble in water, but it is convenient to use the conception of normal solution to determine how much will be dissolved by an acid solution of known strength. One liter of normal hydrochloric acid will dissolve one-half mole of $\text{Mg}(\text{OH})_2$.

Salts of weak acids and strong bases have an alkaline reaction. With methyl orange as indicator, sodium carbonate reacts with two moles of hydrochloric acid; hence the equivalent weight is one-half mole of sodium carbonate. With phenolphthalein, however, the end point is reached when one mole of sodium carbonate has reacted with one mole of hydrochloric acid; in this case the normal solution will contain one mole of sodium carbonate.

The equivalent weight of an oxidizing agent is determined by the change in polarity which the reduced element experiences. The polarity of an element is the sum of the positive and negative valence bonds which it has in a compound; it represents the state

of oxidation. Usually the polarity is the same as the valence, but sometimes, as is true of the nitrogen atom of an ammonium salt, there is a difference. Nitrogen in the ammonium radical has a valence of five, but four of the bonds are negative toward hydrogen atoms and the fifth bond is positive toward the acid ion of the ammonium salt. The polarity of nitrogen in an ammonium salt is -3 and it corresponds to the same state of oxidation as ammonia, NH_3 .

When potassium permanganate is used as an oxidizing agent, the manganese drops to a lower polarity. In permanganate the polarity of the manganese atom is $+7$ and in most reactions used in volumetric analysis, the manganese is reduced to manganous salt in which the manganese has a polarity of $+2$:

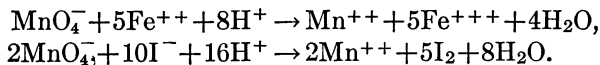

A normal solution of potassium permanganate, therefore, will contain one-fifth of a mole of KMnO_4 because the atom of manganese loses 5 positive charges in changing from a polarity of $+7$ to $+2$.

Sometimes, however, the manganese of potassium permanganate is reduced only to the quadrivalent state. Thus a nearly neutral solution of a manganous salt can be made to react with permanganate as follows:



In this case the manganese atom in permanganate only loses three charges and a normal solution of permanganate will contain only one-third of a mole of the reagent. Usually permanganate is standardized by a reaction in which it is reduced to manganous salt. Throughout this book, therefore, a normal solution of permanganate will refer to one containing one-fifth mole of KMnO_4 per liter.

Potassium dichromate is often used as an oxidizing agent. In it each chromium atom has a polarity of $+6$ and by reduction two trivalent chromic ions are formed. There is a loss in polarity of three charges for each chromium atom and a normal solution of potassium dichromate, $\text{K}_2\text{Cr}_2\text{O}_7$ will contain one-sixth of a mole.*

* The valence of an ion is the algebraic sum of the polarities of its constituents. Except in peroxides, oxygen has a polarity of -2 . The polarity of the chromium can be determined from the charge of the ion and that of the oxygen. The same is true of permanganate or of any other complex ion.

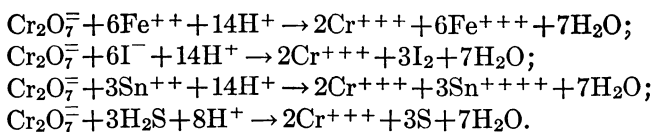

In like manner, the equivalent weight of a reducing agent is determined by the gain in polarity which the oxidized element experiences. Ferrous salts are oxidized to ferric salts and the iron is changed from +2 to +3 in polarity. Of ferrous sulphate, $\text{FeSO}_4 \cdot 7\text{H}_2\text{O}$, or ferrous ammonium sulphate,

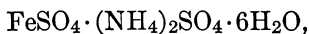

a normal solution will contain one mole of either salt per liter.

As precipitants, the normal solutions are referred to the simplest type of salt in which each constituent has a valence of one. Thus of sodium chloride NaCl , and of silver nitrate, AgNO_3 , a normal solution will contain one mole per liter. Of sodium sulphate, Na_2SO_4 , barium chloride, BaCl_2 , and magnesium sulphate, MgSO_4 , a normal solution will contain one-half mole per liter.

If potassium dichromate is used as a precipitant,

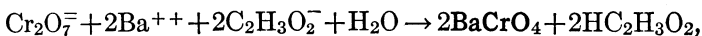

the normal solution will contain one-fourth mole per liter.

Oxalic acid and the acid oxalates are used sometimes as acids and sometimes as reducing agents. Oxalic acid, $\text{H}_2\text{C}_2\text{O}_4$, has two replaceable hydrogens when titrated against alkali with phenolphthalein as indicator. and a normal solution as an acid contains one-half mole per liter;

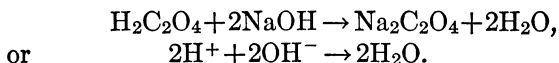

Oxalic acid also reacts with permanganate in accordance with the following equation:

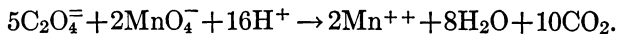

From the fact that the normal solution of permanganate contains one-fifth mole per liter, it is clear that the equivalent weight of oxalic acid as a reducing agent is one-half mole, just as when acting as an acid. In this case, however, the reducing power has nothing whatever to do with the hydrogen ion content of oxalic acid, for the above reaction takes place in the presence of a mineral acid. The

valence of carbon in oxalic acid is four and the structural symbol, leaving out the water of crystallization, is written thus:

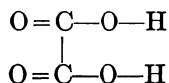

This structural symbol shows that each carbon atom is positive toward three atoms of oxygen but, on the assumption that one end of each valence bond is positive and the other negative, one bond of a carbon atom is positive toward another atom of carbon. The polarity of one carbon atom is, therefore, +4 while that of the other carbon atom is +2. When oxalic acid is heated, H_2O , CO and CO_2 are formed, which agrees with this assumption. The average polarity of the carbon in oxalic acid is +3 and this same result is obtained by applying the rule given in the foot-note on page 532 to the C_2O_4^- ion.

By the reaction with permanganate, each carbon atom is changed to carbon dioxide. The reducing power of oxalic acid, therefore, is due to the C_2O_4^- ion, and this ion is equivalent to two atoms of hydrogen as a reducing agent.

Potassium acid oxalate, KHC_2O_4 , can be used as an acid

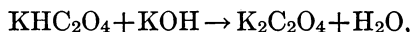

in which case the equivalent weight is one mole of KHC_2O_4 , but as a reducing agent the reducing power is due to the oxalate group and a normal solution will contain only one-half mole of KHC_2O_4 . A solution of KHC_2O_4 which is normal as an acid will be twice normal as a reducing agent.

Potassium tetroxalate behaves similarly. As an acid it has three replaceable hydrogens and the equivalent weight is one-third of a mole:



As a reducing agent, potassium tetroxalate has two C_2O_4^- groups and the equivalent weight is one-fourth mole. If a solution of potassium tetroxalate contains one mole per liter it is 3-normal as an acid and 4-normal as a reducing agent and the same relation holds of all concentrations.

Preparation of Normal Solutions.

The required amount of substance should be dissolved in water at 15° and diluted to a volume of 1 liter while at this temperature. In most cases, however, the water is not at the normal temperature of 15°, so that it is customary to dissolve the substance in water at the laboratory temperature and then dilute the solution up to the mark in a liter flask. After thoroughly mixing the solution, its temperature is taken by a sensitive thermometer. If the temperature is above 15°, as is usually the case, the volume of the solution would be less than 1 liter if it were cooled to exactly 15°, so that the solution as made up is a little too strong. The error can be computed as follows:

Not only the solution, but the glass of the flask should have been at the normal temperature of 15°. The coefficient of cubical expansion for glass may be taken as α , and that of the solution as β . The volume of the flask, and that of the solution is equal to $1000[1+\alpha(t-15)]$ c.c., but this volume of solution at t° would assume at 15° a volume of

$$1000 \frac{1+\alpha(t-15)}{1+\beta(t-15)} \text{ c.c.}$$

Schlösser * has worked out the following table (see page 534) to show how much greater or less a given volume is at different temperatures than it would be at exactly 15°.

The use of the tables on pp. 534, 536 and 537 can be best explained by a few examples:

1. A liter flask is calibrated to contain exactly 1000 true c.c. at 15°. A normal solution of sodium hydroxide is prepared at 25°. The table shows that the solution at 25° would occupy at 15° 2.85 c.c. less, so that in order to make the solution exactly normal, 2.85 c.c. of water should be added.

2. In a titration 47.35 c.c. of normal sodium hydroxide solution were used which was at a temperature of 19°; this amount of solution would at the normal temperature occupy a volume of

$$47.35 - \frac{47.35 \times 0.76}{1000} = 47.31 \text{ c.c.}$$

3. If a normal solution of common salt is prepared at 25°, it

* Chem. Ztg., 1904, 4; 1905, 510.

TABLE FOR THE REDUCTION OF THE VOLUME OF WATER, NORMAL, AND TENTH NORMAL SOLUTIONS TO THE NORMAL TEMPERATURE OF 15° C.

Temperature.	Water and $\frac{1}{10}$ n. Solutions.	$\frac{1}{1}$ n. HCl.	$\frac{1}{1}$ n. $\text{H}_2\text{C}_2\text{O}_4$.	$\frac{1}{1}$ n. H_2SO_4 .	$\frac{1}{1}$ n. HNO_3 .	$\frac{1}{1}$ n. Na_2CO_3 .	$\frac{1}{1}$ n. NaOH
5°	+0.60	+1.26	+1.33	+1.94	+2.00	+2.03	+2.18
6	0.60	1.18	1.25	1.79	1.84	1.87	1.99
7	0.59	1.10	1.16	1.63	1.68	1.69	1.80
8	0.56	1.00	1.05	1.46	1.50	1.50	1.60
9	0.52	0.88	0.94	1.28	1.31	1.31	1.39
10	0.46	0.76	0.81	1.09	1.11	1.11	1.18
11	0.40	0.63	0.67	0.89	0.91	0.90	0.96
12	0.33	0.48	0.52	0.68	0.69	0.69	0.73
13	0.22	0.33	0.35	0.46	0.46	0.47	0.50
14	+0.12	+0.17	+0.18	+0.23	+0.23	+0.24	+0.25
15	0.00	0.00	0.00	0.00	0.00	0.00	0.00
16	-0.13	-0.18	-0.20	-0.24	-0.25	-0.24	-0.25
17	0.27	0.36	0.40	0.49	0.50	0.49	0.51
18	0.42	0.56	0.61	0.75	0.76	0.75	0.78
19	0.59	0.76	0.82	1.02	1.03	1.02	1.05
20	-0.76	-0.97	-1.05	-1.30	-1.30	-1.29	-1.33
21	0.95	1.19	1.29	1.58	1.58	1.57	1.62
22	1.94	1.41	1.54	1.86	1.87	1.85	1.92
23	1.35	1.64	1.80	2.15	2.17	2.14	2.23
24	1.56	1.88	2.07	2.45	2.47	2.44	2.54
25	1.79	2.14	2.34	2.76	2.78	2.75	2.85
26	2.02	2.40	2.62	3.08	3.10	3.06	3.17
27	2.27	2.67	2.90	3.41	3.43	3.38	3.50
28	2.52	2.95	3.19	3.75	3.76	3.70	3.83
29	2.75	3.23	3.49	4.09	4.10	4.04	4.17
30	-3.06	-3.52	-3.82	-4.43	-4.44	-4.38	-4.52

is evident that the volume of one liter when reduced to the normal temperature would be $1000 - 1.79 = 998.21$ c.c. The solution is, therefore, too strong, for it contains as much sodium chloride as should be present in 1000 c.c. at the normal temperature. 1 c.c. of this solution is equivalent to 1.0018 c.c. of a normal solution prepared at 15°.

This number is called the *factor* of the solution, for if the number of cubic centimeters actually used is multiplied by it, the result represents the corresponding number of cubic centimeters of exactly tenth-normal solution.

Similarly in all future experiments, the actual volume should be reduced to the normal temperature when the greatest accuracy is desired. This reduction can be accomplished by means of the

tables on pages 536 and 537 for tenth-normal solution, and by the table on page 534 for more concentrated solutions.

If 20 c.c. of a tenth-normal solution is used at 25° this would correspond at the normal temperature of 15° to $20 - 0.04 = 19.96$ c.c. (cf. p. 537).

Now calibrated vessels serve not only for the measurement of water but for other dilute and concentrated liquids. The question arises as to whether the volumes as determined by weighing water are accurate for those liquids which differ greatly from water as regards viscosity, adhesion and capillarity. In the case of vessels calibrated for contents, the only difference is that arising from the different nature of the meniscus; but even in the most unfavorable instances no appreciable error is occasioned. Schlösser and Grimm* have carefully studied the amount of error in vessels calibrated for delivery. According to them there is no correction needed for tenth-normal solutions except in the case of iodine. With normal solutions a correction is needed at the most only with hydrochloric and oxalic acids and with liquids in the nature of alkalies and ferric chloride (1 c.c. = 0.012 gm. Fe). In the case of concentrated liquids it is those containing alcohol in which the deviations are most marked. Thus Boutron and Boudet found that with an alcohol soap solution, 0.255 c.c. less was delivered from a 100 c.c. pipette than of water, and from a 25-c.c. pipette, 0.103 c.c. less. With concentrated alkalies and acids the deviations were also quite marked; thus with 95% sulphuric acid, 0.442 c.c. less were delivered from a 100-c.c. pipette and 0.085 c.c. less from a 10-c.c. pipette than when water was used. The amount of time allowed for the draining of the pipette exerts an important effect in this connection. If the pipette is allowed to drain for a long time the negative correction becomes smaller and may even become positive. It would be well, then, for the chemist to determine the amount of time required to drain a pipette with water and with any other liquid, and if the difference exceeds two seconds to then determine the contents of the pipette for the other liquid. If it be desired to avoid this difficulty, the pipettes may be graduated both for contents and for delivery. The pipette is then filled with the special liquid to the mark

* Chem. Ztg., 1906, 1071.

TABLE FOR THE REDUCTION OF THE VOLUME OF A N/10
(Correction is given in

Burette Reading, in c.c.	5°	6°	7°	8°	9°	10°	11°	12°	13°	14°	15°	16°
1	+0	+0	+0	+0	+0	+0	+0	+0	+0	+0	+0	-0
2	0	0	0	0	0	0	0	0	0	0	0	0
3	0	0	0	0	0	0	0	0	0	0	0	0
4	0	0	0	0	0	0	0	0	0	0	0	0
5	0	0	0	0	0	0	0	0	0	0	0	0
6	0	0	0	0	0	0	0	0	0	0	0	0
7	0	0	0	0	0	0	0	0	0	0	0	0
8	0	0	0	0	0	0	0	0	0	0	0	0
9	0	0	0	0	0	0	0	0	0	0	0	0
10	+0	+0	+0	+0	+0	+0	+0	+0	+0	+0	+0	-0
11	1	1	1	1	0	0	0	0	0	0	0	0
12	1	1	1	1	1	0	0	0	0	0	0	0
13	1	1	1	1	1	1	0	0	0	0	0	0
14	1	1	1	1	1	1	0	0	0	0	0	0
15	1	1	1	1	1	1	1	0	0	0	0	0
16	1	1	1	1	1	1	1	0	0	0	0	0
17	1	1	1	1	1	1	1	0	0	0	0	0
18	1	1	1	1	1	1	1	0	0	0	0	0
19	1	1	1	1	1	1	1	1	0	0	0	0
20	+1	+1	+1	+1	+1	+1	+1	+1	+0	+0	+0	-0
21	1	1	1	1	1	1	1	1	0	0	0	0
22	1	1	1	1	1	1	1	1	0	0	0	0
23	1	1	1	1	1	1	1	1	0	0	0	0
24	1	1	1	1	1	1	1	1	0	0	0	0
25	1	1	1	1	1	1	1	1	0	0	0	0
26	1	1	1	1	1	1	1	1	0	0	0	0
27	2	2	1	1	1	1	1	1	0	0	0	0
28	2	2	2	1	1	1	1	1	1	0	0	0
29	2	2	2	2	1	1	1	1	1	0	0	0
30	+2	+2	+2	+2	+1	+1	+1	+1	+1	+0	+0	-0
31	2	2	2	2	2	1	1	1	1	0	0	0
32	2	2	2	2	2	1	1	1	1	0	0	0
33	2	2	2	2	2	1	1	1	1	0	0	0
34	2	2	2	2	2	2	1	1	1	0	0	0
35	2	2	2	2	2	2	1	1	1	0	0	0
36	2	2	2	2	2	2	1	1	1	0	0	0
37	2	2	2	2	2	2	1	1	1	0	0	0
38	2	2	2	2	2	2	1	1	1	0	0	0
39	2	2	2	2	2	2	1	1	1	0	0	0
40	+2	+2	+2	+2	+2	+2	+2	+1	+1	+0	+0	-0
41	2	2	2	2	2	2	2	1	1	0	0	0
42	2	2	2	2	2	2	2	1	1	0	0	0
43	2	2	2	2	2	2	2	1	1	0	0	0
44	3	3	3	2	2	2	2	1	1	0	0	0
45	3	3	3	2	2	2	2	1	1	0	0	1
46	3	3	3	2	2	2	2	1	1	0	0	1
47	3	3	3	3	2	2	2	1	1	0	0	1
48	3	3	3	3	2	2	2	1	1	0	0	1
49	3	3	3	3	2	2	2	1	1	0	0	1
50	+3	+3	+3	+3	+3	+2	+2	+2	+1	+0	+0	-1

*Computed according to

SOLUTION TO THE NORMAL TEMPERATURE OF 15° C.

$\frac{1}{100}$ cubic centimeters.*)

17°	18°	19°	20°	21°	22°	23°	24°	25°	26°	27°	28°	29°	30°
-0	-0	-0	-0	-0	-0	-0	-0	-0	-0	-0	-0	-0	-0
0	0	0	0	0	0	0	0	0	0	0	0	0	0
0	0	0	0	0	0	0	0	0	0	1	1	1	1
0	0	0	0	0	0	0	1	1	1	1	1	1	1
0	0	0	0	0	0	1	1	1	1	1	1	1	1
0	0	0	0	1	1	1	1	1	1	1	1	2	2
0	0	0	1	1	1	1	1	1	2	2	2	2	2
0	0	0	1	1	1	1	1	2	2	2	2	2	3
-0	-0	-0	-1	-1	-1	-1	-1	-2	-2	-2	-2	-3	-3
0	0	1	1	1	1	1	2	2	2	2	3	3	3
0	0	1	1	1	1	2	2	2	3	3	3	3	4
0	0	1	1	1	2	2	2	2	3	3	3	4	4
0	1	1	1	1	2	2	2	3	3	4	4	4	5
0	1	1	1	2	2	2	3	3	3	4	4	5	5
0	1	1	1	2	2	2	3	3	4	4	4	5	5
0	1	1	1	2	2	2	3	3	4	4	5	5	6
-0	-1	-1	-1	-2	-2	-3	-3	-4	-4	-4	-5	-5	-6
0	1	1	2	2	2	3	3	4	4	5	5	6	6
1	1	1	2	2	2	3	3	4	4	5	6	6	7
1	1	1	2	2	3	3	4	4	5	6	6	7	7
1	1	1	2	2	3	3	4	5	5	6	6	7	8
1	1	1	2	2	3	3	4	5	5	6	6	7	8
1	1	1	2	2	3	3	4	5	6	6	7	7	8
1	1	1	2	2	3	3	4	5	6	6	7	8	8
1	1	2	2	3	3	4	4	5	6	6	7	8	8
1	2	2	3	3	4	4	5	6	6	7	7	8	9
-1	-1	-2	-2	-3	-3	-4	-5	-5	-6	-7	-7	-8	-9
1	1	2	2	3	3	4	5	5	6	7	8	9	9
1	1	2	2	3	4	4	5	6	6	7	8	9	10
1	1	2	2	3	4	4	5	6	7	7	8	9	10
1	1	2	2	3	4	4	5	6	7	8	8	9	10
1	1	2	3	3	4	5	5	6	7	8	9	10	11
1	1	2	3	3	4	5	6	6	7	8	9	10	11
1	1	2	3	3	4	5	6	7	7	8	9	10	11
1	2	2	3	4	4	5	6	7	8	9	9	10	12
1	2	2	3	4	4	5	6	7	8	9	10	11	12
-1	-2	-2	-3	-4	-4	-5	-6	-7	-8	-9	-10	-11	-12
1	2	2	3	4	5	5	6	7	8	9	10	11	12
1	2	2	3	4	5	6	6	7	8	9	10	11	12
1	2	2	3	4	5	6	7	8	9	10	11	12	13
1	2	2	3	4	5	6	7	8	9	10	11	12	13
1	2	3	3	4	5	6	7	8	9	10	11	12	13
1	2	3	3	4	5	6	7	8	9	10	11	12	14
1	2	3	3	4	5	6	7	8	9	10	12	13	14
1	2	3	4	4	5	6	7	8	10	11	12	13	14
1	2	3	4	5	6	6	8	9	10	11	12	14	15
-1	-2	-3	-4	-5	-6	-6	-8	-9	-10	-11	-12	-14	-15

the table on page 49.

corresponding to the former graduation, it is allowed to drain, and then the remaining solution is carefully washed out.

SUBDIVISIONS OF VOLUMETRIC ANALYSIS.

- I. Acidimetry and Alkalimetry.
- II. Oxidation and Reduction Processes.
- III. Precipitation Processes.

I. ACIDIMETRY AND ALKALIMETRY.

This covers the analysis of acids and bases. In order to determine the amount of acid present, an alkaline solution of known strength is required; and conversely, in the analysis of a base, an acid solution is required. In both cases the "end-point" of the reaction is determined with the help of a suitable indicator. The accuracy of the result depends largely upon the choice of the indicator, so that at this place a few words will be said with regard to the indicators most frequently used for detecting the presence of acids or alkalis.

INDICATORS.

The indicators used in acidimetry and alkalimetry are dyestuffs which are of one color in acid solutions and another color in dilute alkali. They are, as a rule, weak acids; though some of them are weak bases. It has been found that in organic compounds the color can usually be traced to a particular arrangement of atoms called a *chromophor*. The change in color, therefore, is caused by a slight rearrangement of the atoms in the molecule. Thus, if the salt of an indicator acid is yellow and on treatment with acid it turns red, this is due to the fact that when the free indicator acid is set free by the action of the stronger acid, it undergoes a change whereby a slight change takes place in the way the atoms are linked together in the molecule, and in fact thereby loses temporarily the ability to dissociate electrolytically as an acid. It is not sufficient, however, to assume that this change of color is caused solely by the fact that the ions have a color other than that of the undissociated molecule; on the contrary it has been shown in certain cases that the ions have the same color

that the undissociated molecule has before the rearrangement of the atoms in the molecule has taken place. On the other hand, as regards the proper use of indicators it is necessary simply to bear in mind how salts of weak acids behave in the presence of stronger acids and how the acids themselves behave in the presence of alkali.

The number of indicators which have been discovered and used more or less is very large, but it will be sufficient here to consider only *methyl orange*, *methyl red*, *lacmoid*, *litmus*, and *phenolphthalein*.

1. Methyl Orange.

Under methyl orange, Lunge,† who first proposed the use of this indicator, understood either the free sulphonic acid of dimethyl-amido-azo-benzene or its sodium or ammonium salt.

In the free state the free sulphonic acid is obtained in the form of reddish-violet scales, soluble in considerable water. If some of the solid is dissolved in as little water as possible, a distinct reddish-orange colored solution is obtained; but on the further addition of water this color gradually changes to yellow. If a trace of an acid is added to the yellow solution, it becomes red again and on further dilution with water the color changes to orange and finally to yellow once more, if too much acid was not added. This color change can be easily explained.

In the sensitive neutral solution there is a condition of equilibrium between two isomeric forms of methyl orange as expressed by the equation:

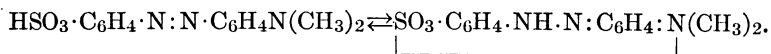

The formula on the left represents the yellow substance and the color is due to the azo group N : N, whereas the formula on the right represents the red substance which has for its chromophore the quinoid group :C₆H₄:. The formula on the left has a sulphonic group which imparts acid properties to the molecule and at the other end is an N(CH₃)₂ group which has weakly basic properties. The formula on the right, therefore, represents an

* This dyestuff is known commercially as helianthin, orange III, tropäolin D, Poirrier's orange III, dimethylaniline orange, mandarine orange, and gold orange.

† Berichte, II (1878), p. 1944; Zeitschr. f. ch. Industrie, 1881, p. 348; Handbuch für Sodaindustrie, I (1879), p. 52; II (1893), p. 151.

inner salt inasmuch as the acid and base forming groups are here united.

The sodium salt of methyl orange is yellow and has the formula

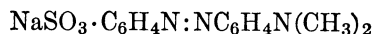

and when decomposed by acids the free sulphonate at once reverts to the red form:

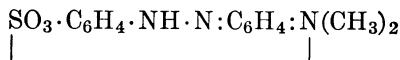

Methyl orange is an excellent indicator for weak bases, but cannot be used for the titration of weak acids.*

If it is desired to titrate a solution containing sodium hydroxide with a tenth-normal acid, a little methyl orange is added to the alkaline solution and the acid is added until the solution is colored a distinct red. The latter color will not appear, however, until an excess of the acid has been added. This causes a slight error in the analysis which is greater in proportion to the amount of indicator employed, and the more dilute the solution.

It is apparent that the weaker the acid character of the indicator the more sensitive it will be, and the opposite is true of indicators which are bases.

From what has been said the following rule holds:

In any titration the smallest amount possible of indicator should be used, and inasmuch as the change of color is proportional to the concentration and not to the absolute amount of acid present, the titrated solution should have as nearly as possible the same concentration as was the case in the standardization of the normal solution.

When a normal acid is used for the titration, the change of color is very sharp when the volume of the solution titrated

* Cf. Stieglitz, *J. Am. Chem. Soc.*, 25, 1117.

amounts to about 100 c.c. Even with a fifth normal solution the change of color is very distinct, but less so with tenth-normal solutions, but these can be titrated provided the standardization was made at the same dilution as that used in the analysis.

How is it with the end-point in the titration of an acid with an alkaline hydroxide solution?

If a few drops of methyl orange are added to 100 c.c. of water. the latter will be colored distinctly yellow. If we imagine that the solution contains the same amount of gaseous hydrochloric acid as is contained in 10 c.c. of a tenth-normal solution of this acid, the solution will be colored a deep red. In order that the solution shall assume its original yellow color, it is only necessary to add exactly 10 c.c. of $\frac{N}{10}$ alkali hydroxide solution, but no excess of alkali, because the water is itself sufficient to decompose the dyestuff sufficiently to produce the yellow color.

It is evident, then, that it is not a matter of indifference in the analysis whether the titration is completed by the addition of acid or by the addition of alkali. In the former case, for the titration of T c.c. of $\frac{N}{10}$ alkali solution, T+t c.c. of $\frac{N}{10}$ acid would be necessary.

Methyl orange is more sensitive toward alkali than it is toward acid, but many prefer to finish the titration by the addition of acid, for most eyes can detect the change from yellow to red with greater accuracy. In principle it is more accurate to accomplish the titration the other way, as was recommended by F. Glaser.

Preparation of Methyl-orange Solution.—The solution of 0.02 gm. of solid methyl orange* dissolved in 100 c.c. of hot water is allowed to cool, and any deposited meta-sulphonic acid is filtered off.

Use.—Methyl orange is suitable for the titration of strong acids (HCl, HNO₃, H₂SO₄) as well as phosphoric and sulphurous acids. Hydrochloric and nitric acids can be titrated with this

* If the free acid is not at hand, 0.022 gm. of the sodium salt is dissolved in 100 c.c. of water, 0.67 c.c. $\frac{N}{10}$ HCl is added, and after standing some time any deposited crystals are filtered off.

indicator with a sharper end-point than is the case with sulphuric acid. If free phosphoric acid is titrated with sodium hydroxide using this indicator, the solution changes from red to yellow when one-third of the phosphoric acid has been neutralized:

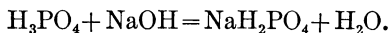

The primary phosphates are neutral toward methyl orange, while the secondary and tertiary phosphates react alkaline toward it. With half-normal solutions, the end-point of the reaction is fairly sharp, with tenth-normal solutions it is less so; in the latter case an excess of about 0.3 c.c. of the tenth-normal alkali is necessary to cause the change from red to yellow.

Sulphurous Acid.—In titrating sulphurous acid with sodium hydroxide, the yellow color is obtained when half the acid has been neutralized,

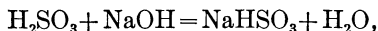

so that NaHSO_3 is neutral toward this indicator.

The weak acids HCN , CO_2 , H_2S , As_2O_3 , B_2O_3 , CrO_3 when present in considerable amount do not act upon the indicator. CO_2 and H_2S produce an orange-red coloration only when present in large amounts. For this reason the alkali salts of these acids can be titrated with accuracy by means of this indicator.

Organic acids cannot be titrated with methyl orange.

The strong and weak bases NaOH , KOH , NH_4OH , $\text{Ca}(\text{OH})_2$, $\text{Sr}(\text{OH})_2$, $\text{Ba}(\text{OH})_2$, and $\text{Mg}(\text{OH})_2$ can be titrated with great accuracy by means of this indicator, and the same is true of the amine bases (methyl and ethyl amines, etc.); on the other hand, such weak bases as pyridine, aniline, and toluidine cannot be titrated.

Nitrous acid ordinarily cannot be titrated with this indicator because the acid destroys it. If, however, an excess of alkali is first added to the solution of nitrous acid, then the methyl orange, the titration can be accomplished with accuracy.

B. THE SODIUM SALT,

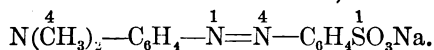

This sodium salt can be used as an indicator in the same way as the free acid; it should be mentioned, however, that the com-

mercial salt often contains small amounts of sodium carbonate as impurity, which causes it to be slightly less sensitive than the free acid.

The change of the yellow color of the solution in this case takes place when the salt has been decomposed by the addition of an equivalent amount of a stronger acid, and the dissociation of the free acid diminished by increasing the concentration of the hydrogen ions. As a matter of fact, however, the amount of acid necessary to effect this change in a solution containing a drop of the indicator solution is inappreciable.

2. Methyl Red.*

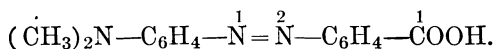

Para-dimethyl-amido-azo-benzene-o-carboxylic acid.

This valuable indicator is suitable for titrating weak organic bases and ammonia. The aqueous solution of methyl red is orange, but if a few drops are added to 50–100 c.c. of water, the latter is colored a pale yellow. The addition of a drop of 0.1 N. HCl at once turns the liquid a violet red without passing through any intermediate shade and by the addition of a drop of ammonia the solution becomes nearly colorless again. Methyl red is not very sensitive toward carbonic acid, but more so than is methyl orange, so that it is less suitable for the titration of carbonates. The chief advantage of this indicator lies in the sharp color change from a very pale yellow to a violet red, even in titrating ammonia.

Preparation of the Indicator. About 0.02 g. of the free acid is dissolved in 100 c.c. of hot water, the solution allowed to cool, and then filtered. Two or three drops of this solution are added for every 100 c.c. of the solution to be titrated.

H. W. Langbeck † recommends the use of ortho-nitrophenol as indicator, but it has no advantages over methyl orange and methyl red. It is not at all sensitive towards carbonic acid. It is turned yellow by alkalis and colorless by acids.

* E. Rupp and R. Loose, *Berichte*, **41**, 3905 (1908).

† *Chem. News*, **43**, 162.

3. Lacmoid, or Resorcin Blue,



Lacmoid is prepared by heating resorcin with sodium nitrite at not too high a temperature. The constitution of the dye has not been completely established. Pure lacmoid is soluble in water (the impure product is difficultly soluble), but more soluble in alcohol, glacial acetic acid, actone, and phenol, and less so in ether. To determine whether a sample of commercial lacmoid is suitable for use as an indicator, a little of it is boiled with water; if the water is colored an intense and beautiful blue, it can be used. In this case the alcoholic solution will be of a pure blue color, and not with a tinge of violet, as is the case with the impure substance.

Preparation of Pure Lacmoid.—The solution of the good commercial product in hot 96 per cent. alcohol is filtered and allowed to evaporate in vacuo over concentrated sulphuric acid.

Preparation of the Indicator.—A solution is used containing 0.2 gm. of the purified lacmoid in 100 c.c. of alcohol.

Behavior of Lacmoid toward Acids and Bases.—If the solution after it has been colored reddish by acid is treated with a solution of an alkali hydroxide, the red color is gradually changed to a violet-red, and on further addition of alkali, it suddenly changes to a pure blue. If the violet solution is diluted with considerable water, it becomes blue.

Uses.—Lacmoid is suitable for the titration of strong acids and bases as well as for ammonia, but is not suited for the titration of nitrous acid or weak acids.

4. Litmus.

The chief coloring principle of litmus, the azolitmin, is a dark-brown powder only slightly soluble in water and insoluble in alcohol and ether. With alkalies it forms a readily soluble blue salt. Besides the azolitmin, there are other dyestuffs present in litmus which are soluble in alcohol with a red color.

Commercial litmus is obtained in small cubes mixed with considerable calcium carbonate; the dyestuffs are then in the form of their calcium salts, soluble in water. If the commercial mate-

trial is dissolved in water, a solution of blue and reddish-violet coloring matter is obtained, which becomes red on the addition of acid. On making alkaline again, a pure blue color is not obtained at first, but a reddish-violet, which becomes blue on the addition of considerable alkali. Such a solution, therefore, is far from being a sensitive indicator and cannot be used for accurate work. A number of different methods have been proposed for obtaining a sensitive litmus solution, and that of F. Mohr* will be described.

Purification of Litmus.—The cubes of litmus are placed in a porcelain dish (without powdering), covered with 85 per cent. alcohol, and digested on the water-bath for some time with frequent stirring. The solution is decanted off and the operation is repeated three times. By this means the undesired coloring matter is removed. The residue is now extracted with hot water, and as it is very difficult to filter the solution, it is poured into a tall cylinder, and after standing several days the clear liquid is siphoned off. The solution is concentrated to about one-third of its volume and acidified with acetic acid in order to decompose the potassium carbonate present. It is then evaporated to a syrupy consistency upon the water-bath and the mass covered with a large amount of 90 per cent alcohol. By this means the blue coloring matter is precipitated, while the remainder of the violet substance remains in solution with the potassium acetate. The residue is filtered off and dissolved in sufficient hot water so that three drops of the solution will be necessary to impart a distinct color to 50 c.c. of water.

Use.—Litmus can be used for the titration of inorganic and strong organic acids, alkali and alkaline-earth hydroxides, and ammonia, as well as for the titration of carbonates in hot solution.

5. Phenolphthalein.

Phenolphthalein is a very weak acid forming red salts which contain the strongly chromophoric quinoid group $:C_6H_4:$. The free acid, however, is unstable and when set free from one of its colored salts reverts instantly into a colorless lactoid form, containing no chromophoric group:

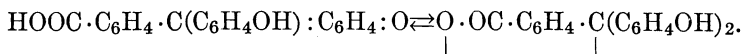

* Lehrbuch der Chemisch-Analytischen Titrimethode.

In the case of the free acid, therefore, the condition of equilibrium favors the lactoid form and only minimal traces of the quinoid acid are present. This trace of quinoid acid is ionized and is in equilibrium with its ions:

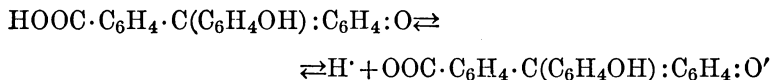

The addition of an alkali causes the hydrogen ions to disappear, so that more of the quinoid molecules must be ionized to preserve equilibrium, and the quinoid molecules in turn be reproduced from the lactoid as fast as the former are converted into the salt. Phenolphthalein is a very sensitive indicator towards acids, but on account of being such a weak acid it does not form stable salts with weak bases.

Preparation of the Indicator.—One gram of pure phenolphthalein is dissolved in 100 c.c. of 86% alcohol.

Uses.—Phenolphthalein is particularly suited for the titration of organic and inorganic acids and strong bases, but not for the titration of ammonia.

If the red-colored solution containing phenolphthalein and a little alkali is treated with an excess of concentrated alkali hydroxide solution, the red color disappears, but returns on diluting the solution with water. Phenolphthalein, therefore, cannot be used as an indicator for the titration of concentrated alkali without previous dilution with water.

Phenolphthalein is the most sensitive indicator we possess toward acids, far more sensitive than methyl orange, for in this case not only can the presence of weak acids be detected, but very small amounts can be titrated with accuracy.

Ordinary distilled water usually contains carbon dioxide, as can be shown by slowly adding $\frac{N}{10}$ barium hydroxide solution, drop by drop, to 100 c.c. of water containing a drop of the indicator solution. Where the alkali first meets the water, a red color is produced which disappears on stirring, so that often as much as 0.5 to 1.8 c.c. of the alkali must be added before a permanent red color is obtained. The disappearance of the red shows the pres-

ence of acid (in this case carbonic acid), and its amount corresponds to the alkali neutralized.

Phosphoric Acid.—If a solution of phosphoric acid containing phenolphthalein is titrated with normal sodium hydroxide solution, a permanent coloration is produced when two-thirds of the phosphoric acid is neutralized:

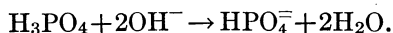

Apparently Na_2HPO_4 reacts neutral toward phenolphthalein, but this is not quite correct, for a pure solution of disodium phosphate is colored by phenolphthalein a pale pink, and on diluting with water the intensity of the color increases owing to progressive hydrolysis:

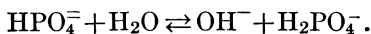

During the titration of phosphoric acid with sodium hydroxide, a pale-pink color is obtained somewhat too soon, and this color gradually increases in intensity until finally a maximum is reached; the latter point is taken as the end-point. It is possible that this hydrolysis could be prevented by the addition of a large excess of sodium chloride and cooling to about zero Centigrade.

Carbonic Acid.—If the solution of a neutral alkali carbonate is treated with phenolphthalein a red color is obtained, showing the presence of hydroxyl ions in the solution, due to hydrolysis:

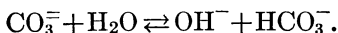

If hydrochloric acid is added to such a solution which is not too dilute and is at a temperature of 0°C ., decolorization is effected when half of the soda has been neutralized. At ordinary temperatures a sharp end-point cannot be obtained; the color gradually fades. Pure sodium bicarbonate dissolved in ice-cold water is not colored by the addition of phenolphthalein; if it is warmed to the temperature of the room it turns red, but on cooling the color disappears (Küster).

Silicic acid seems to be without influence upon phenolphthalein; for alkali silicates (the water-glasses) can be titrated with accuracy.

Chromic Acid and Acid Chromates are changed by the addition of alkali to neutral chromates and the latter have no action upon phenolphthalein.

Alkali aluminates can be titrated accurately with this indicator for aluminium hydroxide does not affect it.

Almost all the problems involved in acidimetry and alkalimetry can be solved by the use of one or the other of these two indicators: methyl orange and phenolphthalein. For further information with regard to the countless other indicators which have been proposed, the student is referred to Glaser's "Indicatoren der Acidimetrie und Alkalimetrie," Wiesbaden, 1901.*

NORMAL SOLUTIONS.

For the standardization of the solutions used in acidimetry and alkalimetry, a great many different methods have been proposed, all of which more or less satisfactorily answer the purpose. It was Gay-Lussac who first proposed the use of chemically-pure, calcined sodium carbonate, and in simplicity and accuracy this method has never been excelled,† so that we will content ourselves with its description.

The chemically-pure sodium carbonate must form a clear solution with water and should contain neither sulphuric nor hydrochloric acids. It is possible to obtain the pure substance commercially, but as a rule it must be purified. For this purpose about 300 gms. of crystallized sodium carbonate are dissolved in 250 c.c. of water at 25–30° C., and quickly filtered into a two-liter flask of Jena glass. After replacing the air by carbon dioxide,‡ the flask is closed by means of a perforated rubber stopper through which a short, right-angled glass tube is passed, and the latter is connected by means of a long piece of rubber tubing with a Kipp-carbon dioxide generator. The contents of the flask are shaken until no more carbon dioxide will be absorbed; this usually takes from half to three-quarters of an hour. In proportion as carbon dioxide is absorbed, sodium bicarbonate is deposited. The solution is cooled to 0° C., while the carbon dioxide is continually passed through it; the thick mass of crystals is transferred to a

* See also J. Wagner, *Zeitschr. für anorg. Chem.*, XXVII (1901), p. 138.

† According to Sörensen, the standardization takes place with equal accuracy by means of anhydrous sodium oxalate, which after weighing is heated until the carbonate is formed; cf. page 597.

‡ The carbon dioxide is passed through a solution containing sodium bicarbonate before it reaches the flask.

filter-plate which is covered with a piece of hardened filter-paper and sucked as dry as possible. The sodium bicarbonate thus obtained often contains considerable chloride and sulphate. It is washed back into the flask by means of 50 c.c. of distilled water (that has been cooled to 0° C. and saturated with carbon dioxide), vigorously shaken, and the mother-liquor once more removed by suction. This operation is repeated until finally 3 gms. of the salt will no longer give the test for chlorides or sulphates.

The pure sodium bicarbonate thus obtained is dried on the water-bath and preserved for further use in a tightly-stoppered bottle.

Normal Hydrochloric Acid.

1000 c.c. contain 1 HCl=36.468 gms.

Pure, concentrated hydrochloric acid is diluted until its specific gravity is about 1.020, and in this way a solution is obtained that is slightly more than normal in strength. To obtain an exactly normal solution, it is titrated against a weighed amount of chemically-pure sodium carbonate, and from the result obtained the amount of water to be added can be computed. About 8 gms. of the pure, dry sodium bicarbonate are placed in a large platinum crucible, and the latter is inserted in an inclined position within a hole in a piece of asbestos board and over a small flame (cf. p. 358). The contents of the crucible are stirred frequently with a short piece of heavy platinum wire, and only the bottom of the crucible is heated to redness. The mass must not be allowed to sinter together or fuse, for in that way an appreciable amount of the normal carbonate would be decomposed. After heating for about half an hour the crucible is cooled in a desiccator, weighed, and to make sure that a constant weight has been obtained, the heating is repeated once or twice more.*

* If it is feared that some of the carbon dioxide may be expelled from the normal carbonate, the bicarbonate may be heated for half an hour at 270–300°. This can be easily accomplished by embedding the platinum crucible, which contains the bicarbonate, in sand, so that the latter extends up on the outside of the crucible as high as the bicarbonate on the inside, and then heat slowly to 230°. The heating is then continued for about half an hour, but taking care that the thermometer in the sand beside the crucible does not register above 300°.

The amount necessary to neutralize 35–40 c.c.* of normal acid (about 2 gms.) is weighed out from a glass-stoppered weighing-tube into a beaker, dissolved in about 100 c.c. of distilled water, and enough methyl orange is added (from 5–6 drops) to impart a pale-yellow color to the solution. The hydrochloric acid at 17–18° C. is added from a burette, with constant stirring, until the color of the solution is changed from yellow to orange. The burette is then read and a drop more of the acid is added to see whether this will produce a pure pink color. If this is not the case, more hydrochloric acid is added until this point is reached, and in this way the number of cubic centimeters of the acid that are required to neutralize the weighed amount of the sodium carbonate is determined. Assuming that for the neutralization of 2.1132 gms. of Na_2CO_3 , 39.20 c.c. of hydrochloric acid at 19° were necessary, how strong is the acid?

If the acid were exactly normal, according to definition (p. 530) 1000 c.c. would neutralize $\frac{\text{Na}_2\text{CO}_3}{2} = \frac{106.00}{2} = 53.00$ gms. of sodium carbonate, so that the amount weighed out would require for neutralization at 15°

$$53.00:1000 = 2.113:x$$

$$x = \frac{2113}{53.00} = 39.87 \text{ c.c.}$$

This would be equivalent to 39.90 c.c. at 19°. †

As, however, only 39.20 c.c. were necessary it is evident that our solution is too strong, and for each 39.20 c.c. of the acid, $39.90 - 39.20 = 0.70$ c.c. of water must be added to make it normal, and to 1 liter:

$$39.2:0.70 = 1000:x$$

$$x = \frac{700}{39.2} = 17.86 \text{ c.c. water.}$$

* It is best not to weigh out more substance than can be titrated with one buretteful, and not too small an amount should be taken, for in the latter case the error in reading is too great.

† According to the table on page 533, 1000 c.c. N. HCl at 19° = 1000 – 0.76 c.c. at 15°; therefore $(1000 - 0.76): 1000 = 39.83:x$, $x = 39.90$ c.c.

A perfectly dry liter flask is, therefore, filled exactly to the mark with acid, and 17.9 c.c. of water are added from a burette (or measuring-pipette), the solution is thoroughly mixed, and the strength of the solution is verified by a second titration with a weighed amount of sodium carbonate. Further, it is to be recommended that the beginner should convince himself of the accuracy of the result by determining the amount of chlorine present gravimetrically as silver chloride. 10 c.c. of normal acid yield 1.4338 gms. AgCl.

For practical purposes it is quite unnecessary to spend the time necessary for the preparation of an exactly normal solution, but its normality* is determined, and if the number of cubic centimeters used is multiplied by this factor, the corresponding amount of normal solution will be obtained. Thus in the above case 39.20 c.c. of acid were used to do the work that would require 39.90 c.c. of normal acid. The solution is, therefore, $\frac{39.90}{39.20} = 1.018$ N. Or, if instead of using 40.10 c.c. it was found that 40.15 c.c. of acid were required, the solution would be $\frac{40.10}{40.15} = 0.9987$ N. Whatever the normality may be, it is written upon a label and pasted upon the bottle containing the acid.

For most purposes, a normal solution is too strong, so that $\frac{1}{2}$, $\frac{1}{5}$ and $\frac{1}{10}$ N solutions are used. Obviously a tenth-normal solution can be prepared by diluting 100 c.c. of a normal solution to 1 liter, etc.

In order to titrate a $\frac{N}{10}$ acid solution with sodium carbonate, about 0.2 gm. of the salt is placed in a white porcelain dish and dissolved in 50 c.c. of water, methyl orange is added until a pale-yellow color is obtained, and acid is added until the color becomes orange. The carbon dioxide is then expelled by heating to boiling, after which the solution is cooled and once more titrated until an orange color is obtained; the second titration requires but about 0.1-0.2 c.c. more, but in this way the correct end-point is obtained. At this dilution the carbon dioxide exerts an imperceptible action upon the indicator.

* By *normality* is understood the relation to a normal solution.

Normal Nitric and Sulphuric Acid Solutions.

These are prepared in the same way as was described in the preparation of normal hydrochloric acid.

$\frac{N}{10}$ Oxalic Acid.

$$1000 \text{ c.c. contain } \frac{H_2C_2O_4 + 2H_2O}{20} = \frac{126.05}{20} = 6.303 \text{ gms.}$$

An oxalic acid solution of this strength can be prepared by dissolving exactly 6.303 gms. of pure, crystallized oxalic acid in water at 17°.5 and diluting to a volume of 1 liter. The commercial acid, however, must always be purified.

The chief impurities found in the commercial product are calcium and potassium oxalates. In order to remove these salts, 500 gms. are dissolved in 500 c.c. of pure, boiling hydrochloric acid of specific gravity 1.075 in a porcelain dish. If an insoluble residue should be obtained, the solution is filtered through a hot-water funnel and the filtrate received in a porcelain evaporating-dish, the latter placed upon ice and cooled as quickly as possible. The fine crystals thus obtained are placed in a funnel provided with a platinum cone and the mother-liquor completely removed by suction. The above process is repeated, and the crystals obtained the second time are washed with a little ice-cold water, re-crystallized three times from hot water, and their purity tested. A solution of 2 gms. of the purified acid should give no sign of a turbidity with silver nitrate, and another portion of 5 gms. should leave no weighable residue after ignition in a weighed platinum dish. After having been dried as completely as possible by suction, the crystals are spread out upon several layers of blotting-paper and allowed to stand in the air for several days; they then have the formula $H_2C_2O_4 + 2H_2O$. The strength of the solution is tested by titration with $\frac{N}{10}$ sodium hydroxide solution using phenolphthalein, as indicator (see p. 553), or with $\frac{N}{10}$ potassium permanganate solution (see p. 598).

Normal Sodium Hydroxide Solution.

1000 c.c. contain 1 NaOH = 40.01 gms.

About 45 gms. of the commercial caustic soda are roughly weighed out, the carbonate on the surface is washed off as much as possible by a stream of water from the wash-bottle, and the alkali is dissolved in a little more than a liter of water. The solution is then allowed to stand for about one hour beside the hydrochloric acid against which it is to be titrated, in order that both solutions may be at the same temperature. About 40 c.c. of the solution are measured off from a burette, and titrated with normal hydrochloric acid after the addition of a few drops of methyl orange solution. The titration is repeated several times with fresh amounts of the sodium hydroxide and from the mean of the results the amount of water to be added is calculated. If, for example,

$$40 \text{ c.c. NaOH} = 41.23 \text{ c.c. N. HCl,}$$

it is evident that 1.23 c.c. of water must be added to each 40 c.c. of the alkali to make the solution exactly normal, and for one liter

$$40:1.23 = 1000:x$$
$$x = \frac{1230}{40} = 30.75 \text{ c.c. water.}$$

After the solution has been diluted with water until it is exactly normal, it must be tested once more with the hydrochloric acid, and from it tenth-normal and fifth-normal hydroxide solutions can be prepared.

The solutions thus obtained always contain carbonate, so that they are not suitable for titration with phenolphthaleïn, but with methyl orange the results obtained are the same as if all of the sodium was present as the hydroxide. With phenolphthaleïn accurate results can be obtained from a boiling-hot solution, or by preparing a solution of alkali free from carbonate.

Titration of Alkali containing Carbonate with Phenolphthaleïn in Hot Solutions.

The alkali is measured into a porcelain dish, a drop of phenolphthaleïn added, and hydrochloric acid of approximately the same strength is run into the solution until the red color disappears.

The solution is then heated to boiling, when the red color soon reappears; it is cooled by placing the dish in cold water,* hydrochloric acid is again added until decolorized, and the process is repeated until finally the red color does not reappear on boiling. This method of titration is tedious, but the results obtained are accurate. On titrating $\frac{N}{10}$ acids with methyl

orange as indicator, there is no sharp change from yellow to pink, as is the case with normal and half-normal solutions, but first a brownish-orange color is obtained which becomes pink on the addition of more acid. The correct end-point is the change from yellow to yellowish brown. Only when considerable carbonate is present will this change occur before enough acid has been added, for in this case the carbon dioxide exerts an action upon the methyl orange.

The disturbing action of carbon dioxide is best prevented by first titrating in the cold, then heating to remove the carbon dioxide, again titrating the *cold* solution with acid. If only a small amount of carbonate is present, it exerts no appreciable effect upon methyl orange.

The titration of oxalic acid with alkali which contains carbonate is best effected with phenolphthaleïn in hot solution. The process is carried out as follows: About 40 c.c. of the sodium hydroxide are accurately measured into a porcelain dish, a few drops of phenolphthaleïn added, and oxalic acid run in from a burette until the solution is decolorized.

The solution is then heated upon the water bath until the red color reappears, whereupon it is decolorized by oxalic acid

* With phenolphthaleïn the titration can be finished in the hot solution, but the end-point is not so sharp.

and the process continued until finally the color does not reappear on heating the solution. This point is reached, however, only after the solution has been evaporated to dryness and the residue taken up with a few cubic centimeters of distilled water. A slight red color will appear after this first evaporation, but it will be discharged by the fraction of a drop of oxalic acid and will not reappear upon a second evaporation.

Remark.—Formerly the author was accustomed to heat the oxalic acid solution over a free flame, but since Christie has found in this laboratory that it was impossible to reach an end point in this way, the use of a free flame has been avoided.

Sörensen met with the same difficulty and attributed the reappearance of the red color to the following reaction having taken place:

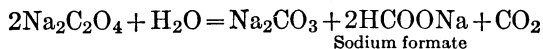

It seems more probable, however, that this reappearance of the red color after the alkali is all neutralized is not due to the decomposition of sodium oxalate *in the solution* but to its being overheated on the sides of the dish, whereby it is decomposed into sodium carbonate and carbon monoxide:

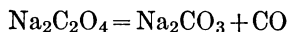

Such a decomposition does not occur when the heating takes place upon a water bath.

Preparation of Sodium Hydroxide Solution Free from Carbonate.

This is best effected as proposed by Küster.* About 40 c.c. of pure alcohol is placed in a small round-bottomed flask, heated to boiling on the water-bath, and little by little 2.5 gms. of bright metallic sodium are added, the latter being freed from petroleum

* *Zeit. f. anorg. Chem.*, 13, 134.

by rubbing between pieces of blotting-paper. The reaction between the boiling alcohol and the sodium is at first very violent and large amounts of hydrogen and alcohol vapors are evolved. During this time the flask is, therefore, kept covered with a watch-glass. Gradually the reaction begins to diminish and finally stops. In the flask there will be a deposit of sodium alcoholate and some undissolved sodium on account of the insufficient amount of alcohol. Small amounts of water free from carbon dioxide* are now added, a test-tube full at a time. The alcohol is almost all boiled away, and in order to completely remove it, a current of air free from carbon dioxide is passed through the solution until the odor of alcohol can no longer be detected. The solution is then quickly cooled by the addition of water free from carbon dioxide, immediately placed in a liter flask, and diluted to the mark with pure water at 17–18° C. This solution

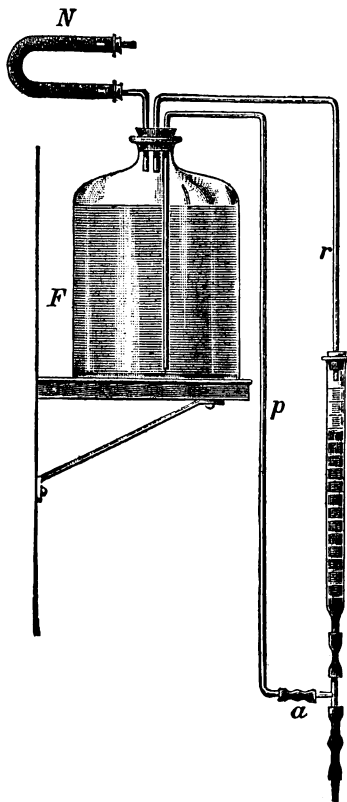

FIG. 87.

will give the same value when titrated with phenolphthalein in a cold solution as when the latter is hot.† With methyl orange correct results are also obtained if the orange color is taken as the end-point.

Such a solution quickly absorbs carbon dioxide from the air. In order to prevent this, it is placed in a bottle as shown in Fig.

* This is accomplished by boiling the water while a current of air free from carbon dioxide is passed through it.

† Provided the hydrochloric acid solution was prepared with water free from carbonate, otherwise too little acid will be necessary when the titration takes place in the cold.

87 which is connected with a soda-lime tube, *N*, and with the burette by means of the tubes *p* and *r*. The burette is filled by squeezing the tube at *a*. In this way a solution can be kept free from carbon dioxide for a long time. In order to determine whether the solution is free from carbonate, two parallel titrations are made with phenolphthaleïn as an indicator, one in the cold and the other in the hot solution. If the results agree the solution is free from carbonate. Otherwise it is necessary either to prepare a fresh solution or to make a corresponding correction in each analysis after determining the amount of carbonate present as described on p. 563.

In many cases it is better to use a $\frac{1}{10}$ normal barium hydroxide solution; as long as it remains clear it is free from carbonate.

Preparation of $\frac{N}{10}$ Barium Hydroxide Solution.

$$1000 \text{ c.c. contain } \frac{\text{Ba(OH)}_2 + 8\text{H}_2\text{O}}{20} = \frac{315.51}{20} = 15.776 \text{ gms.}$$

The crystallized barium hydroxide of commerce always contains barium carbonate, so that the solution cannot be prepared by simply weighing out the necessary amount and diluting to 1 liter. About 20 gms. of the commercial product are dissolved in the necessary amount of distilled water within a large flask. The flask is closed and shaken until the crystals have completely disappeared and a light, insoluble powder of barium carbonate remains. The solution is allowed to stand for two days, until the barium carbonate has completely settled, when it is siphoned into a bottle through which a current of air free from carbon dioxide has been passed for two hours previous, after which the bottle is connected with a soda-lime tube and with the burette as shown in Fig. 87. For the titration, 50 c.c. $\frac{N}{10}$ hydrochloric acid are placed in an Erlenmeyer flask, a little phenolphthaleïn is added, and the solution titrated by the addition of the barium hydroxide solution. The normality found should be written upon the label. It is not advisable to make the solution exactly $\frac{N}{10}$ for it usually becomes turbid on dilution.

A. ALKALIMETRY.

I. Determination of Alkali Hydroxides.

Rule.—If the substance to be analyzed is a solid, an accurately weighed amount is dissolved in enough water so that the solution is at about the same concentration as that of the acid to be used in the titration. If, on the other hand, a solution of an alkali hydroxide in water is to be analyzed, the specific gravity of the solution is determined by weighing in a pycnometer or by means of an areometer, and then diluted to the amount desired.

(a) *Determination of Sodium Hydroxide in Commercial Caustic Soda,*

$$\text{NaOH} = 40.01.$$

For the titration a $\frac{N}{10}$ hydrochloric acid solution can be used. Consequently in this case an approximately $\frac{N}{10}$ normal solution of the alkali is prepared. As sodium hydroxide absorbs water and carbon dioxide from the air, the sample for analysis is weighed out in a tared watch-glass and dissolved in water to a definite volume. After thoroughly mixing the solution a pipetted portion is treated with methyl orange and titrated in the cold with $\frac{N}{10}$ hydrochloric acid.

Example.—4.6623 gms. sodium hydroxide were dissolved in 1000 c.c. of solution and 25 c.c. of the latter, corresponding to 0.11656 gm. sodium hydroxide, required 28.66 c.c. $\frac{N}{10}$ hydrochloric acid for neutralization.

Since 1000 c.c. of $\frac{N}{10}$ acid correspond to 4.001 gms. NaOH, it is evident that 1 c.c. $\frac{N}{10}$ acid = $\frac{4.001}{1000} = 0.004006$ gm. NaOH, and 28.66 c.c. $\frac{N}{10}$ acid correspond to $0.004001 \times 28.66 = 0.1147$ gm. NaOH.

This amount of NaOH was contained in 25 c.c. of solution, equivalent to 0.1166 gm. of the solid substance, so that the per cent. of sodium hydroxide present can be calculated:

$$0.1166 : 0.1147 = 100 : x$$

$$x = \frac{11.48}{0.1166} = 98.38 \text{ per cent. NaOH.}$$

(b) *Determination of Sodium Hydroxide Present in Caustic Soda Solution.*

For the titration assume that a $\frac{N}{2}$ solution is at hand:

$$1000 \text{ c.c.} = \frac{\text{NaOH}}{2} = 20.00 \text{ gms. NaOH.}$$

The alkali solution to be analyzed has a specific gravity of 1.285 at 15° C., and by consulting the table (see the supplement) we find that the solution should contain 25.80 per cent. NaOH by weight; i.e., 100 gms. of the solution should contain 25.80 gms. NaOH. Usually instead of weighing out the solution it is measured and the per cent. by volume is computed.

As 128.5 gms. of the alkali occupy a volume of 100 c.c. we have

$$100 : 25.8 = 128.5 : x$$

$$x = 33.153 \text{ gms. NaOH in 100 c.c.}$$

Now as 1 liter of $\frac{N}{2}$ sodium hydroxide contains 20.00 gms. NaOH, we can compute how much of the alkali must be taken to be diluted to 1000 c.c. in order to make a $\frac{N}{2}$ solution;

$$100 : 33.153 = x : 20.00$$

$$x = \frac{2003}{33.153} = 60.32 \text{ c.c.}$$

We measure, therefore, 60 c.c. into a liter flask, dilute with water just to the mark, shake thoroughly, and by means of a pipette 25 c.c. of the solution are removed and titrated with half-normal acid, using methyl orange as an indicator.

Assume that 25 c.c. of the solution require 24.3 c.c. of $\frac{N}{2}$ acid for neutralization. As 1000 c.c. $\frac{N}{2}$ acid contain $\frac{\text{NaOH}}{2} = 20.0$ gms. NaOH, it is evident that 1 c.c. of the acid corresponds to 0.02000 gm. NaOH, and 24.3 c.c. $\frac{N}{2}$ acid is equivalent to $0.02000 \times 24.3 = 0.4860$ gm. NaOH.

25 c.c. of the dilute alkali, therefore, contain 0.4860 gm. NaOH, and 1000 c.c. of the dilute solution, or 60 c.c. of the original alkali, contain $0.4860 \times 40 = 19.44$ gms. NaOH, and 100 c.c. of the original solution contain

$$60:19.44 = 100:x$$

$$x = \frac{1944}{60} = 32.40 \text{ gms. NaOH.}$$

In order to obtain the per cent. by weight, this number must be divided by the specific gravity.

In the assumed case we have:

$$\frac{32.40}{1.285} = 25.21 \text{ per cent. NaOH.}$$

Remark.—The titration of alkali hydroxides with methyl orange as an indicator will only give correct results when the alkali hydroxide is free from carbonate, which with commercial material is never the case. The above results are too high, for they represent the total amount of alkali, i.e. the amount of $\text{NaOH} + \text{Na}_2\text{CO}_3$, though the latter is expressed in terms of NaOH. For an accurate determination of alkali hydroxide in the presence of alkali carbonate, see p. 563.

(c) *Determination of Ammonia in Aqueous Ammonia.*

The procedure is the same as under (b).

(d) *Determination of Ammonia in Ammonium Salts.*

A weighed amount of the ammonium salt is placed in the flask *K* (Fig. 24, p. 59),* dissolved in about 200 c.c. of water, and

* Or better, the apparatus shown in Fig. 78, p. 454, may be used.

treated with 10 c.c. of a boiled solution of 10 per cent. caustic soda. The solution is distilled, and the distillate received in a known amount of normal acid in the receiver *V*, as described on p. 59. The excess of acid is titrated with normal alkali, using methyl orange as an indicator and the ammonia calculated from the difference between the amount of acid now found and that originally in the receiver.

Example.—The amount of ammonia in a sample of commercial ammonium sulphate is to be determined. As the technical product is never entirely pure, a large amount of the substance is weighed out, and for the sake of convenience this can amount to the gram-equivalent of ammonia, i.e. 17.03 gms. This quantity of the salt is dissolved in 500 c.c. of distilled water, and for the analysis, 50 c.c. of this solution are taken (1.703 gms. of salt). This is placed in the flask *K* (Fig. 23, p. 59), diluted with 150 c.c. of water, and distilled after the addition of 10 c.c. of 10 per cent. caustic soda solution. The distillate is received in 60 c.c. of half-normal hydrochloric acid, the excess of the latter titrated with half-normal alkali, and from the difference the amount of ammonia calculated. For the titration, t c.c. of $\frac{N}{2}$ alkali are necessary; consequently the amount of ammonia in 1.703 gms. of the substance neutralized $60 - t$ c.c. $\frac{N}{2}$ acid. This corresponds to $(60 - t) \times 0.008515$ gm. NH_3 and in per cent.

$$1.703 : (60 - t) \times 0.008515 = 100 : x$$

$$x = \frac{(60 - t) 0.8515}{1.703} = \frac{60 - t}{2} = \text{per cent. } \text{NH}_3.$$

(e) *Titration of Pyridine Bases. Method of K. E. Schulze.**

1000 c.c. N. acid = $\text{C}_5\text{H}_5\text{N}$ = 79.05 gms. pyridine.

The pyridine bases are so weak that they cannot be titrated with ordinary indicators. If, however, an aqueous pyridine solution is treated with an aqueous solution of ferric chloride, the iron is precipitated as ferric hydroxide:

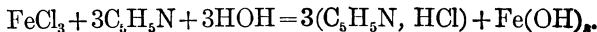

* *Berichte*, 20 (1887), p. 3391.

If normal sulphuric acid is very carefully added with constant stirring until the precipitate redissolves, each cubic centimetre of the acid required will correspond to $\frac{C_5H_5N}{1000} = 0.07905$ gm. pyridine.

Procedure.—5 c.c. of pyridine are dissolved in 100 c.c. of water, 25 c.c. of the resulting solution are treated with 1 c.c. of 5 per cent. aqueous ferric chloride solution, and the precipitate of reddish-brown ferric hydroxide is titrated with normal sulphuric acid until completely dissolved.

2. Determination of Alkali Carbonates.

Alkali carbonates can be titrated in the cold by using methyl orange as an indicator, the end-point being taken as the change from yellow into reddish orange. When fifth-, half-, and normal acids are used this is the correct end-point, but with tenth-normal acids this change is obtained a little too soon, for large amounts of carbonic acid exert a slight action upon the indicator. In this case the difficulty is best overcome by titrating the solution until the orange color is obtained, then heating to boiling to expel the carbon dioxide, cooling, and again titrating until the now yellow solution becomes orange again.* With phenolphthaleïn, accurate results may be obtained by titrating the hot solution (cf. p. 554). According to Warder,† sodium bicarbonate solution reacts neutral toward phenolphthaleïn in the cold, so that when a sample of sodium carbonate is titrated in the cold, with phenolphthaleïn as an indicator, an end-point is obtained when the carbonate is changed to bicarbonate:

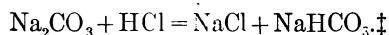

If the acid is allowed to run upon the carbonate solution, a part of the carbon dioxide from the sodium bicarbonate is lost, so that too much acid must be added before the end-point is reached. On the other hand, correct results may be obtained if

* Küster recommends in titrating carbonates with methyl orange, that a blank experiment be made to see how much effect an equal amount of water saturated with carbon dioxide has upon the same amount of indicator solution. (*Zeitschr. für anorg. Chem.*, XIII, p. 140.)

† *Zeitschr. f. analyt. Ch.*, 21, p. 102.

‡ *Zeitschr. f. anorg. Ch.*, XIII, p. 140.

the titration is carried out at 0° in the presence of NaCl (cf. p. 547). This is important, for in this way a convenient method is obtained for determining the amount of hydroxide in the presence of carbonate.

3. Determination of Alkali Carbonate and Hydroxide in the Presence of one Another.

(a) Method of C. Winkler.

Of the many methods which have been proposed for this determination that of Winkler is the best.

In one portion the total amount of alkali present is determined by titration with acid, using methyl orange as an indicator, and the hydroxide in a second portion is determined as follows: The solution is treated with barium chloride solution, when the following reaction take place:

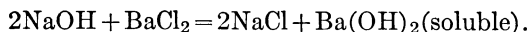

The sodium of the carbonate is transformed into neutral sodium chloride, while insoluble barium carbonate is precipitated from the solution; the sodium hydroxide, however, yields an equivalent amount of barium hydroxide. If the solution containing phenolphthalein is slowly titrated with hydrochloric acid with constant stirring, decolorization is effected as soon as the hydroxide is neutralized. The amount of acid used corresponds to the amount of hydroxide originally present.

Example:

1. 20 c.c. ($\text{Na}_2\text{CO}_3 + \text{NaOH}$) require T c.c. $\frac{N}{10}$ acid for $\text{Na}_2\text{CO}_3 + \text{NaOH}$,

2. 20 c.c. ($\text{Na}_2\text{CO}_3 + \text{NaOH}$) “ t “ $\frac{N}{10}$ “ “ NaOH alone,

so that

20 c.c. ($\text{Na}_2\text{CO}_3 + \text{NaOH}$) require $T - t$ c.c. $\frac{N}{10}$ acid for Na_2CO_3 ;

20 c.c. of the solution, therefore, contain

(a) $t \times 0.004001$ gm. NaOH,

(b) $(T - t) \times 0.005300$ gm. Na_2CO_3 .

Remark.—It has been proposed to add an excess of barium chloride solution to the mixture of alkali carbonate and hydroxide

contained in a measuring-flask, then dilute to the mark, thoroughly mix, and filter through a dry filter; for the titration an aliquot part of the filtrate is taken. This method, however, will only give accurate results when the water used for the dilution is absolutely free from carbon dioxide, and this will be the case only when it is previously boiled with a current of air free from carbon dioxide passing through it. Further, no attention is paid to the volume occupied by the precipitated barium carbonate, and in the case of a large amount of the latter, a considerable error is introduced. The method of Winkler does not have these disadvantages. Care must be taken, however, with regard to the addition of the hydrochloric acid in the titration; unless it is added very slowly some of the barium carbonate will be acted upon before the end-point is reached.

(b) *Method of R. B. Warder.*

To the *cold** solution containing phenolphthaleïn, hydrochloric acid is added and the liquid is gently stirred with a glass rod. Decolorization takes place when all of the hydroxide and half of the carbonate are neutralized:

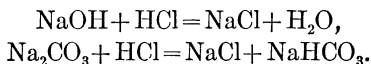

To the colorless solution, methyl orange is added, and the solution is again titrated with acid until the other half of the carbonate is neutralized, when the solution turns brownish-red.

If the amount of acid used for the titration with phenolphthaleïn is represented by T , and that necessary for the titration with methyl orange by t , then

$2t$ c.c. corresponds to the amount of carbonate present, and $T-t$ represents the amount of hydroxide.

4. Determination of Alkali Bicarbonates.

The solution is titrated in the cold until an orange color is obtained with methyl orange, or until a colorless solution is obtained by titrating hot with phenolphthaleïn. (See page 553.)

* The results are accurate only when the solution is at 0° and NaCl is present. Cf. Küster. *Zeitschr. f. anorg. Chem.*, XIII, p. 134 (1897).

5. Determination of Alkali Carbonates in the Presence of Alkali Bicarbonates.

(a) *Method of C. Winkler.*

The total alkali is determined in one portion by titration with hydrochloric acid, using methyl orange as an indicator, and in a second portion the amount of bicarbonate is determined as follows:

A definite volume of the solution is treated with an excess of sodium hydroxide, by which means the bicarbonate is changed to neutral carbonate:

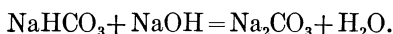

The solution now contains sodium carbonate with the excess of sodium hydroxide, and the amount of the latter is determined as described under 3. In other words, barium chloride is added, then phenolphthaleïn, and the solution is titrated until colorless. The amount of acid now used corresponds to the excess of sodium hydroxide added, and if this amount is deducted from the total sodium hydroxide, the corresponding amount of bicarbonate will be obtained.

Example:

25 c.c. $\text{Na}_2\text{CO}_3 + \text{NaHCO}_3$ required T c.c. $\frac{N}{10}$ acid for

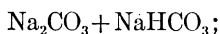

25 c.c. $\text{Na}_2\text{CO}_3 + \text{NaHCO}_3 + T_1$ c.c. $\frac{N}{10}$ $\text{NaOH} + \text{BaCl}_2$

required t c.c. $\frac{N}{10}$ acid for the excess of NaOH ;

25 c.c. $\text{Na}_2\text{CO}_3 + \text{NaHCO}_3$, therefore, require $T_1 - t$ c.c. $\frac{N}{10}$ acid

for the NaHCO_3 and $T - (T_1 - t)$ c.c. $\frac{N}{10}$ acid for the Na_2CO_3 .

25 c.c. of the original solution contain

(a) $(T_1 - t) \times 0.008401$ gm. NaHCO_3 ,

(b) $(T - T_1 + t) \times 0.005300$ gm. Na_2CO_3 .

Remark.—In order to make sure that enough sodium hydroxide solution is present, the same amount of the $\frac{N}{10}$ alkali is added as there were cubic centimeters used of $\frac{N}{10}$ acid in the determination of the total alkali; in this case, then, $T = T_1$, and t , the excess of alkali, corresponds at the same time to the amount of Na_2CO_3 present. The caustic alkali solutions, even when originally free from carbonate, gradually absorb it from the air, so that in every case the amount of carbonate in the alkali should be determined before making the above analysis and a corresponding correction applied to the calculation.

(b) *Method of Warder.**

Using phenolphthaleïn as indicator, the solution is titrated with hydrochloric acid until colorless, and in this way half of the carbonate is determined. Methyl orange is then added and the solution titrated until a brownish-red color is obtained, and in this way the total amount of the bicarbonate together with half of the carbonate is determined. If t represents the amount of acid used in the first titration, and T the total amount used, then:

$2t$ c.c. of acid correspond to the amount of carbonate and $(T - 2t)$ c.c. correspond to the bicarbonate.

6. Determination of Alkaline-earth Hydroxides.

The solution containing phenolphthaleïn is titrated until colorless.

7. Determination of Alkaline-earth Carbonates.

The carbonate is dissolved in an excess of the standard acid, boiled to remove the carbon dioxide, and the excess of acid titrated with alkali, using methyl orange as indicator in cold solution.

* Cf. Am. Ch. Journ., 3, No. 1, and Chem. News, 43, 223.

8. Determination of Alkaline-Earth Oxide together with Alkaline-Earth Carbonate.

This analysis is based upon the fact that calcium carbonate as well as calcium oxide, neutralizes a solution which is acid to methyl orange and changes the color of the indicator. One mole of CaCO_3 reacts with 2 moles HCl before the solution is acid to methyl orange. Toward phenolphthalein calcium oxide is basic, but calcium carbonate is not, and the end-point is reached when all the calcium oxide is neutralized and the calcium carbonate begins to dissolve.

Suppose, for example, it is desired to determine the amount of oxide and carbonate in a sample of "quicklime." The lime is broken up into pieces about the size of a pea, exactly 14 gm.s. are accurately weighed out and slaked with boiled water, the paste is washed into a 500-c.c. flask and diluted to the mark with water free from carbon dioxide. After thoroughly mixing, 50 c.c. of the turbid liquid is transferred to a second 500-c.c. flask and again diluted to the mark.

Determination of the Total Calcium.—50 c.c. (0.14 gm. of substance) of the last solution are treated with 60 c.c. of $\frac{N}{10}$ hydrochloric acid and heated until there is no further evolution of carbon dioxide, the solution is cooled, and the excess of the acid titrated with $\frac{N}{10}$ caustic soda solution, using methyl orange as an indicator. For this purpose t c.c. of the latter are required; consequently $60-t$ c.c. $\frac{N}{10}$ acid were necessary to neutralize the calcium hydroxide and calcium carbonate in the 50 c.c. of the solution taken for analysis.

Determination of the Calcium Oxide.—A second portion of the freshly-shaken solution is titrated with $\frac{N}{10}$ hydrochloric acid added drop by drop to the cold solution, using phenolphthalein as an indicator. Assume that t_1 c.c. of the acid were necessary to neutralize the calcium oxide.

Consequently, for the neutralization of the $\text{CaCO}_3 + \text{CaO} =$

$60 - t$ c.c. $\frac{N}{10}$ acid were required, and for the CaO, t_1 c.c. $\frac{N}{10}$ acid were necessary. For the neutralization of the CaCO₃, therefore, $60 - (t + t_1)$ c.c. $\frac{N}{10}$ acid were necessary.

50 c.c. solution (0.14 gm. lime) contain:

(a) $t_1 \times 0.002805$ gm. CaO, (b) $[60 - (t + t_1)] \times 0.5005$ gm. CaCO₃, and in per cent.

$$0.14 : t_1 \times 0.002805 = 100 : x$$

$$x = \frac{t_1 \times 0.2805}{0.14} = 2t_1 \text{ per cent. CaO}$$

and

$$0.14 : [60 - (t + t_1)] \times 0.005005 = 100 : x_1$$

$$x_1 = \frac{[60 - (t + t_1)] \times 0.5005}{0.14} \text{ per cent. CaCO}_3.$$

9. Determination of Alkaline-Earth Bicarbonates.

This determination finds a practical application in the determination of the temporary hardness of water.

The hardness of a water is caused by the presence of alkaline-earth salts, either those with strong acids (CaSO₄, MgCl₂) or bicarbonates. A hard water is recognized by the fact that it gives with a clear soap solution a turbidity or even a precipitate, and considerable soap must be added before a lather is obtained on shaking. As in a majority of cases calcium salts, and chiefly calcium bicarbonate, predominate in such a solution, its hardness is usually expressed in parts of calcium carbonate (or calcium oxide) in 100,000 parts of water.

If the solution contains 1 part of calcium carbonate in 100,000 parts of water it is said to possess one degree of hardness (French); if such a water contains n parts of CaCO₃ in the same quantity of water it possesses n degrees of hardness. In Germany the hardness is expressed in parts of CaO per 100,000 parts of water, while in England the hardness is expressed in grains of calcium carbonate per Imperial gallon. In the United States hardness is usually expressed in grains of calcium carbonate per U. S. gallon, which is five-sixths as large as the Imperial gallon. One degree of hardness

on the French scale=0.56 degree on the German scale=0.70 degree on the English scale=0.585 degree on the U. S. scale. When magnesium salts are present, these are expressed in terms of the equivalent amounts of CaCO_3 or CaO . The error caused by this assumption is not great, for the amount of magnesium present is usually small compared with the amount of calcium. If a water containing calcium bicarbonate and calcium sulphate is heated to boiling, the former is decomposed with the precipitation of calcium carbonate,

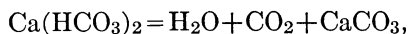

while the calcium sulphate remains in solution. In other words, the hardness produced by the presence of alkaline-earth bicarbonates disappears on boiling, and is designated, therefore, as "temporary hardness" to distinguish it from "permanent hardness," which is usually caused by alkaline-earth salts of the stronger acids, usually calcium sulphate. The sum of the temporary and permanent hardness of a water represents the total hardness.

According to O. Hehner, the temporary as well as permanent hardness may be determined accurately by an alkalimetric process.

(a) *Determination of Temporary Hardness.*

100 c.c. of the water to be examined are placed in a white porcelain evaporating-dish, a few drops of methyl orange are added and the solution is titrated with $\frac{N}{10}$ hydrochloric acid until the first change from yellow to orange takes place. From the amount of hydrochloric acid used the amount of calcium carbonate present is calculated.

Example:

100 c.c. water required 2.5 c.c. $\frac{N}{10}$ hydrochloric acid.

As 1000 c.c. $\frac{N}{10}$ hydrochloric acid neutralize $\frac{\text{CaCO}_3}{20} = 5.005$ gms.

CaCO_3 , 1 c.c. $\frac{N}{10}$ hydrochloric acid will neutralize 0.005005 gm.

CaCO_3 and 2.5 c.c. of $\frac{N}{10}$ hydrochloric acid corresponds to $0.005005 \times 2.5 = 0.0125$ gm. CaCO_3 .

Then if 100 c.c. of water contain 0.125 gm. CaCO_3 , 100,000 c.c. of water will contain 12.5 gms. CaCO_3 .

(b) *Determination of the Permanent Hardness.*

Another portion of 100 c.c. of the water is treated with an excess of $\frac{N}{10}$ sodium carbonate solution, evaporated on the water-bath to dryness, and taken up in a little freshly-boiled, distilled water. The residue is filtered and washed four times with hot water, while the filtrate is allowed to cool and afterwards titrated with $\frac{N}{10}$ hydrochloric acid, using methyl orange as indicator. If the amount of hydrochloric acid used for the titration is deducted from the total amount of sodium carbonate added to the water, the difference represents the amount of sodium carbonate required for the precipitation of the alkaline-earth salts of the strong acids.

Example.—100 c.c. of water + 10 c.c. $\frac{N}{10}$ Na_2CO_3 were evaporated to dryness, the residue extracted with water, and the filtrate titrated with $\frac{N}{10}$ hydrochloric acid; this required 8.7 c.c. of HCl. Consequently, for the precipitation of the calcium sulphate $10 - 8.7 = 1.3$ c.c. $\frac{N}{10}$ Na_2CO_3 were necessary, which corresponds to $1.3 \times 0.005 = 0.0065$ gm. CaCO_3 per 100 c.c. water and 6.5 gms. CaCO_3 per 100,000 c.c. water.

The permanent hardness amounts to 6.5 French degrees or $6.5 \times 0.56 = 3.64$ German degrees.

Remark.—The above methods of Hehner for the determination of hardness will give reliable results only when the water contains no alkali carbonates in solution, as is usually the case with drinking-waters. For the determination of the amount of alkaline earth present in many *mineral waters* it is obvious that these methods cannot be used.

10. Determination of Alkaline-earth Salts of Strong Acids.

The determination is practically the same as was indicated above. The alkaline-earth salt is precipitated by means of an excess of titrated sodium carbonate solution, and after filtration the excess of the latter is determined by titrating back with acid.

Procedure.—A solution containing calcium chloride and hydrochloric acid is to be analyzed. It is placed in a measuring-flask, treated with a few drops of methyl orange and with sodium hydroxide solution until the neutral point is reached, after which an accurately measured amount of sodium carbonate solution is added. The solution is heated until the precipitated calcium carbonate becomes crystalline, allowed to cool, diluted up to the mark, mixed, filtered through a dry filter, and the excess of sodium carbonate titrated in an aliquot part of the filtrate. From the amount of sodium carbonate required for the precipitation of the calcium the amount of the metal can be calculated.

Remark.—Other metals which are precipitated by sodium carbonate can be determined in this way.

B. ACIDIMETRY.

Acids are determined either by titration with standard alkali solution or a known amount of the latter is added and the excess titrated with standard acid. The latter method requires more burette readings and is, therefore, less satisfactory than the former.

Determination of the Acid Contents of Dilute Mineral Acids (HCl, HNO₃, H₂SO₄).

The specific gravity of the acid is determined by means of an areometer and from the tables in the back of this book the approximate amount of acid present is determined. A weighed amount of the acid is then diluted so that the solution will have approximately the same concentration as that of the alkali to be used for the titration. It is analyzed by one of the following methods:

1. An accurately-measured portion of the diluted acid (20 to 25 c.c.) is placed in a beaker, methyl orange is added, and the solution is titrated with sodium hydroxide solution until a yellow color is obtained.

2. The dilute solution to be analyzed is placed in a burette, and with it a definite amount of normal alkali is titrated.

3. A definite volume of the diluted acid is titrated with $\frac{N}{10}$ Ba(OH)₂ solution or with sodium hydroxide free from carbonate, using phenolphthaleïn as an indicator.*

Example.—For the analysis $\frac{N}{2}$ NaOH is at hand.

The hydrochloric acid to be analyzed had at 15° C. a specific gravity of 1.122, corresponding to about 24 per cent. HCl by weight.

1000 c.c. $\frac{N}{2}$ sodium hydroxide are equivalent to $\frac{\text{HCl}}{2} = \frac{36.47}{2} = 18.23$ gms. HCl, and 100 c.c. $\frac{N}{2}$ NaOH neutralize 1.823 gms. HCl.

Consequently

$$100:24 = x:1.823$$

$$x = \frac{182.3}{24} = 7.595 \text{ gms. of the above acid}$$

would be required to make 100 c.c. of $\frac{N}{2}$ acid, if it contained exactly 24 per cent. HCl. About this quantity (say 8 gms.) is, therefore, weighed out, and as the specific gravity of the solution is 1.122, this will require $\frac{8}{1.122} = 7.1$ c.c. About 7 c.c. of the acid are placed in a tared, glass-stoppered weighing-tube, the tube and its contents weighed, the latter washed into a 100-c.c. measuring-flask and diluted with distilled water up to the mark. After thoroughly mixing, 25 c.c. of the acid are measured off and analyzed by one of the above methods. Assume that the original weight of the acid amounted to 7.9623 gms. and that 25 c.c. of the diluted acid required 25.80 c.c. of $\frac{N}{2}$ alkali, then 100 c.c. would require $25.80 \times 4 = 103.2$ c.c. of $\frac{N}{2}$ alkali, corresponding to $103.2 \times 0.01823 = 1.8813$

* When phenolphthaleïn is used as an indicator in cold solutions the acids must be diluted with water free from carbonate.

gms. HCl and in per cent.

$$7.962:1.881=100:x$$

$$x=\frac{188.1}{7.962}=23.6 \text{ per cent. HCl.}$$

Remark.—Instead of weighing out the acid for the analysis, it can be measured and from the per cent. by volume found the per cent. by weight calculated. As, however, the specific gravity as determined by an areometer is not very accurate, it is better to weigh the acid.*

Analysis of Commercial Hydrous Stannic Chloride.

Stannic chloride, as used for a mordant in dyeing, is obtained as the solid salt $\text{SnCl}_4 + 5\text{H}_2\text{O}$, or in a concentrated aqueous solution of about 50° Bé.

The latter is obtained by dissolving metallic tin in hydrochloric acid and oxidizing the stannous chloride formed either with potassium chlorate or potassium nitrate. The preparation should contain no free acid, especially nitric acid, no stannous chloride, and no iron. The substance is, therefore, tested qualitatively for these substances as follows:

For stannous chloride, by dissolving in water (or diluting the concentrated solution) and adding mercuric chloride; a white precipitate of mercurous chloride shows the presence of bivalent tin.

For nitric acid, by means of ferrous sulphate and concentrated sulphuric acid.

For sulphuric acid (caused by the use of impure hydrochloric acid in the preparation of the salt) with barium chloride.

For iron, with potassium sulphocyanate.

The solid salt $\text{SnCl}_4 + 5\text{H}_2\text{O}$, made by treating anhydrous stannic chloride with the calculated amount of water, is almost always found to be very pure.

* If the specific gravity of the acid is taken with a pycnometer, using all necessary precautions (cf. Kohlrausch, Leitfaden der praktischen Physik), it is a matter of indifference whether the acid used for the analysis is weighed or measured.

The gravimetric determination of both the tin and the chlorine has been described on p. 321, but here will be given a method for determining the amount of the latter volumetrically.

If stannic chloride is diluted with water, the salt is hydrolytically decomposed, and the solution reacts acid:

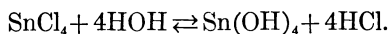

Consequently if methyl orange is added to the diluted solution, the amount of acid may be titrated with caustic soda solution, and from the amount used the chlorine combined with the tin can be calculated, provided no other acid is present. If the stannic chloride was prepared by oxidation with potassium chlorate or nitrate,* the solution will also contain chlorine combined with potassium. The total chlorine can be determined by adding a few drops of neutral potassium chromate solution to the solution which has been titrated with sodium hydroxide, and titrating with silver nitrate solution. If in this way more chlorine is found than corresponds to the amount of hydrochloric acid neutralized by the alkali, the difference is expressed in terms of potassium chloride. If, on the other hand, less chlorine is found, the presence of some other acid in the tin solution is assured.

To illustrate the accuracy of such an analysis, the following results will be given: A sample of solid stannic chloride ($\text{SnCl}_4 + 5\text{H}_2\text{O}$) was analyzed gravimetrically, as described on p. 321. It was found to contain 42.02 per cent. of chlorine and 34.73 per cent. of tin.

Two portions were then analyzed volumetrically by titration first with sodium hydroxide and then with silver nitrate:

A. 0.8533 gm. of tin salt required 20.06 c.c. $\frac{N}{2}$ sodium hydroxide and 20.34 c.c. $\frac{N}{2}$ silver nitrate. As 1 c.c. $\frac{N}{2}$ solution corresponds to 0.01773 gm. of chlorine, it is evident that 20.06 c.c. $\frac{N}{2}$

* The potassium nitrate is acted upon by the excess of hydrochloric acid present forming the chloride, and the excess of the acid is afterwards removed by evaporation as much as possible.

sodium hydroxide represent $20.06 \times 0.01773 = 0.3556$ gm. chlorine or 41.67 per cent. Cl, and 20.34 c.c. $\frac{N}{2}$ silver solution show $20.34 \times 0.01773 = 0.3605$ or 42.25 per cent. Cl.

B. 0.8383 gm. of tin salt required 19.79 c.c. $\frac{N}{2}$ sodium hydroxide and 19.92 c.c. $\frac{N}{2}$ silver nitrate. 19.79 c.c. $\frac{N}{2}$ sodium hydroxide represent $19.79 \times 0.01773 = 0.3508$ gm. chlorine or 41.84 per cent. Cl. 19.92 c.c. $\frac{N}{2}$ silver solution show $19.92 \times 0.01773 = 0.3531$ gm. chlorine or 42.12 per cent. Cl.

The above analysis shows that the tin salt was practically free from potassium chloride by the comparative agreement of the results obtained by titration with sodium hydroxide with those of the silver nitrate titration. In the absence of free hydrochloric acid, the tin can be determined from the amount of chlorine found:

$$\begin{array}{r} 4\text{Cl} \quad \text{Sn} \\ 141.84 : 119.0 = 41.75 * : x \end{array}$$

$x = 35.03$ per cent. tin instead of 34.73 per cent. as found gravimetrically.

Remark.—It is only permissible to compute the amount of tin present from the amount of chlorine found by titration when there is no free hydrochloric acid present. It is never possible to know whether this is the case or not, so that the volumetric determination is only useful as a check upon the gravimetric method.

Determination of the Acid Contents of Fuming Acids.

Highly concentrated acids must be always weighed and not measured, in order to avoid loss by evaporation. The weighing is best accomplished by means of the Lunge-Rey pipette, shown in Fig. 88.

* 41.75 is the mean of the values obtained by titration with alkali.

The lower tube is removed, $\frac{1}{2}$ c.c. of water is placed within it, and this is weighed together with the dry upper pipette, but the two parts are left unconnected. The lower stop-cock is closed, the upper one opened, and a slight vacuum is produced in the bulb by sucking through the upper tube and then closing the stop-cock. The dry point of the pipette is now introduced into the fuming acid (in the case of solid pyrosulphuric acid it is first liquefied by warming slightly) and the lower stop-cock is opened. As soon as the widened part of the pipette below the lower bulb is $\frac{1}{2}$ to $\frac{3}{4}$ full, the stop-cock is closed, taking care that none of the liquid reaches up to it.

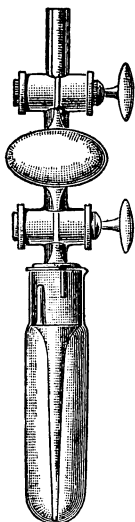

FIG. 88.

The acid on the outside of the pipette is carefully wiped off with filter-paper; the two parts of the pipette are now connected for the first time and again weighed. The amount of acid taken for the analysis should amount to from 0.5 to 1 gm. The point of the pipette is then dipped into about 100 c.c. of distilled water contained in a beaker, and, by opening first the upper stop-cock and then the lower, the acid is allowed to run into the water. The amount remaining in the two parts of the pipette is also washed into the beaker.

If the acid to be analyzed is hydrochloric or sulphuric acid, methyl orange is added and the solution is titrated with a half-normal sodium hydroxide. If it is nitric acid, an excess of sodium hydroxide is first added, then a little methyl orange, and the titration is completed with $\frac{N}{2}$ hydrochloric acid.* When one of the above pipettes is not available, the weighing out of the sample for analysis can be effected as follows: A thin-walled bulb with about 1 c.c. capacity is blown between two ends of capillary tubing. After weighing, the upper piece of capillary tubing is connected with a small, ordinary pipette, at the ends of which are attached

* In this way the action of the ever-present nitrous acid upon the indicator is avoided.

pieces of rubber tubing, and the latter are closed with pinch-cocks. The bulb is filled as follows:

The lower pinch-cock is closed, the upper one opened, and a vacuum produced by sucking through the upper tube and then closing the pinch-cock. The lower point of the weighed tube is introduced into the acid and the lower pinch-cock opened. When the small bulb is one-third full the pinch-cock is closed, the upper end of the capillary tubing is melted together, and, after wiping off the acid from the outside, the lower end is likewise sealed, and the bulb weighed. About 100 c.c. of water are placed in a flask with a closely fitting ground-glass stopper, the weighed bulb is thrown in, and it is broken by shaking. In this way the very strongest, fuming sulphuric acid can be dissolved in water without loss. On the other hand, the pipette shown in Fig. 88 is not so good for the weighing out of an acid containing 70 per cent. or more of SO_3 . If the acid is not too concentrated, this bulb may be emptied as was described for the pipette.

For the analysis of the solid anhydride, Stroof places a little in a dry weighing tube, and concentrated sulphuric acid of known strength is added until a fuming acid of about 70 per cent. SO_3 is obtained. To effect solution, the mixture is warmed to about 30° to 40° C. in a loosely stoppered bottle. The acid thus obtained is analyzed as above.*

Computation of the SO_3 Contents of a Fuming Sulphuric Acid.

The above titration gives not only the sulphuric anhydride present, but also the never-failing SO_2 . In a separate portion, therefore, the amount of the latter is determined by titration with a $\frac{N}{10}$ iodine solution (see Iodimetry), an equivalent amount is subtracted from the total amount of sodium hydroxide used, and from the difference the total SO_3 present is computed.

With regard to the SO_2 , the following reactions take place during the titrations:

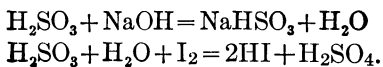

* G. Finch (Chem. Ztg., 1910, 297) and R. H. Vernon (*ibid.*, 1910, 702) use a different apparatus and larger samples, thus getting more accurate results.

It is to be noted in the first reaction that, although sulphurous acid is a dibasic acid, the end-point is reached, with methyl orange as an indicator, when the first hydrogen atom has been neutralized. From the two equations, then, it is evident that 2 gm. atoms of iodine are equivalent to 1 gm. molecule of NaOH, or 1 c.c. $\frac{N}{10}$ iodine solution is equivalent to $\frac{1}{2}$ c.c. $\frac{N}{10}$ sodium hydroxide.

Since, in general, 5 c.c. $\frac{N}{10}$ solution = 1 c.c. $\frac{N}{2}$ solution, then

$$1 \text{ c.c. } \frac{N}{10} \text{ solution} = \frac{1}{5} \text{ c.c. } \frac{N}{2} \text{ solution,}$$

and in the given case 1 c.c. $\frac{N}{10}$ iodine = $\frac{1}{5}$ c.c. $\frac{N}{2}$ sodium hydroxide;

so that if T c.c. $\frac{N}{2}$ alkali were used in the first titration of the

total acid present, and t c.c. of $\frac{N}{10}$ iodine solution for the oxidation

of the sulphurous acid, it is plain that $T - \frac{t}{5}$ represents the amount of alkali necessary for the neutralization of the total sulphuric acid.

The SO_3 is determined by an indirect analysis.

We will assume that the fuming acid consisted of

$$\begin{array}{r} \text{H}_2\text{SO}_4 = x \\ \text{SO}_3 = y \\ \text{SO}_2 = a \\ \hline 100 \end{array}$$

then $100 - a = x + y$.

In order to determine x and y a second equation is necessary, and this is found from the titration of the total sulphuric acid. Assume that, after the deduction corresponding to the amount of SO_2 has been made, the total amount of H_2SO_4 was found to be p per cent., then:

$$1. \quad x + y = 100 - a$$

$$2. \quad x + my = p$$

$$y = \frac{p + a - 100}{m - 1} = \text{per cent. } \text{SO}_3$$

$$x = 100 - (a + y) = \text{per cent. H}_2\text{SO}_4$$

In equation 2, $m = \frac{\text{H}_2\text{SO}_4}{\text{SO}_3} = \frac{98.086}{80.07} = 1.2250$

and

$$m - 1 = 0.2250$$

*Example.**—3.5562 gms. of fuming acid were diluted to 500 c.c., and of this amount 100 c.c. = 0.7112 gm. were taken for analysis.

1. 100 c.c. required 5.40 c.c. $\frac{N}{10}$ iodine = $5.4 \times 0.003203 = 0.01730$ gm. $\text{SO}_2 = 2.43$ per cent. $\text{SO}_2 = a$.

2. 100 c.c. required 34.40 c.c. $\frac{N}{2}$ sodium hydroxide

From the latter must be deducted 0.54 c.c. to correspond to the amount of alkali necessary for the SO_2 . $34.40 - 0.54 = 33.86$ c.c.

$$33.86 \times 0.02452 = 0.8305 \text{ gm. H}_2\text{SO}_4 = 116.7 \text{ per cent.} = z$$

If these values are introduced in the above equations we obtain

$$y = \frac{119.16 - 100}{0.2250} = \frac{19.16}{0.2250} = 85.15 \text{ per cent. SO}_3$$

and

$$x = 100 - (85.15 + 2.43) = 12.42 \text{ per cent. H}_2\text{SO}_4.$$

The acid contains, therefore:

$$\begin{array}{r} \text{H}_2\text{SO}_4 = 12.42 \text{ †} \\ \text{SO}_3 = 85.15 \\ \text{SO}_2 = 2.43 \\ \hline 100.00 \end{array}$$

* Lunge, Zeitschr. f. angew. Ch., 1895, p. 221.

† Like all indirect analyses, the results obtained are not absolutely accurate. Almost all fuming acids contain solid constituents which are neglected in the above calculation. It would be more accurate to determine the amount of the latter in a separate portion, by weighing the residue on ignition.

Preparation of Concentrated Sulphuric Acid Mixtures (M. Gerster.)

It is often necessary to prepare fuming sulphuric acid of definite concentration.

Given:

(a) Fuming sulphuric acid (*A*) with *a* per cent. free SO_3 .

(b) Sulphuric acid (*B*) with *c* per cent. H_2SO_4 and $100-c$ per cent. water.

A fuming acid containing *b* per cent. free SO_3 is desired.

To obtain the latter, 100 gms. of the acid *A* are mixed with *x* gms. of the acid *B*. It must be remembered, however, that the water in the acid *B* requires SO_3 in order to form 100 per cent. H_2SO_4 :

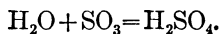

The acid *B* requires for the water present in each 100 gms

$$\text{H}_2\text{O} : \text{SO}_3 = (100-c) : y$$

$$y = \frac{(100-c) \text{SO}_3}{\text{H}_2\text{O}} = \frac{(100-c) 80.06}{18.02} = 4.44 (100-c) \text{ gms. SO}_3.$$

If 100 gms. of the acid *B* require $4.44 (100-c)$ gms. SO_3 from *A*, then

x gms. of the acid *B* require $0.0444 (100-c) x$ gms. SO_3 from *A*.

Now

$$\begin{aligned} & \text{A} + \text{B} \\ (100+x) : [a - 0.0444 (100-c)x] &= 100 : b \\ x &= \frac{100(a-b)}{444 + b - 4.44c} \text{ gms. of B.} \end{aligned}$$

Example.—The fuming acid *A* contains 25.5 per cent. free $\text{SO}_3 = a$.

Sulphuric acid *B* contains 98.2 per cent. $\text{H}_2\text{SO}_4 = c$.

The acid desired is to contain 19.0 per cent. $\text{SO}_3 = b$.

If these values are inserted in the above equations, we obtain

$$x = \frac{100(25.5 - 19.0)}{444 + 19 - 4.44 \times 98.2} = \frac{650}{27} = 24.07 \text{ gms. H}_2\text{SO}_4, \text{ B.}$$

We must add, therefore, 24.07 gms. of the 98.2 per cent. sulphuric acid to 100 gms. of the fuming acid in order to obtain an acid containing 19.0 per cent. of free SO_3 .

Titration of Hydroxylamine Salts.

Hydroxylamine hydrochloride reacts neutral towards methyl orange and acid towards phenolphthaleïn. If the latter is added to an aqueous solution of the salt, and the titration is made with $\frac{N}{10}$ alkali, the end-point will be obtained when the total amount of acid present has been neutralized by the alkali. It is impossible to determine the amount of free hydrochloric acid present when phenolphthaleïn is used, but it can be done with methyl orange. Romijn* recommends for the titration of the acid a $\frac{N}{10}$ borax solution.

Hydrofluoric Acid.

1000 c.c. normal alkali = HF = 20.01 gms. HF.

Hydrofluoric acid can be titrated with phenolphthaleïn as an indicator, but not with litmus or methyl orange. The acid is measured out into a platinum dish by means of a pipette which is coated with beeswax, an excess of sodium hydroxide free from alkali is added, and the excess of the latter is titrated in hot solution with an acid of known strength.†

Hydrofluosilicic Acid.

The titration of this acid may take place according to either of the following reactions:

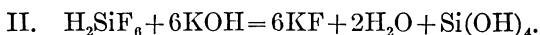

* Z. anal. Chem., 36 (1897), 19. This method has not been tested in the author's laboratory.

† Cf. Winteler, Z. angew. Chem., 1902, p. 33.

According to Equation I.

1000 c.c. normal KOH or Ba(OH)₂ = 72.16 gms. H₂SiF₆.

Author's Method.

If hydrofluosilicic acid is titrated in the cold with caustic potash, using phenolphthalein as indicator, a red color appears after a time, but disappears later on account of the excess alkali reacting according to the equation:

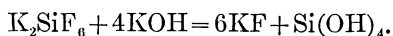

This last reaction, however, takes place so slowly that it is impossible to obtain a distinct end point. If, however, the solution is diluted with an equal volume of alcohol, then 2 or 3 drops of phenolphthalein added, it can be titrated with tenth-normal potassium or barium hydroxide. The insoluble potassium or barium fluosilicate separates out and is not acted upon by an excess of the alkali, so that a sharp end point is obtained. Sodium hydroxide forms a soluble salt so that the titration cannot be made with this reagent.

*Indirect Method of Penfield.**

Penfield treats the solution to be titrated with an excess of KCl, dilutes with an equal volume of alcohol, and then titrates the hydrochloric acid set free in the reaction,

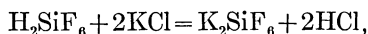

with tenth-normal sodium hydroxide solution, using cochineal as indicator. Methyl red is preferable to the cochineal.

According to Equation II.

1000 c.c. normal NaOH = 24.05 gm. H₂SiF₆.

(a) Method of Sahlbom and Hinrichsen.†

The solution is titrated at the temperature of the water-bath with tenth-normal sodium hydroxide solution, using phenolphthalein as indicator.

* Chem. News, **39**, 179.

† Ber., **39**, 2609 (1906).

*(b) Method of Schucht and Möller.**

The solution to be titrated is treated with an excess of neutral calcium chloride solution (25 c.c. of 4N. CaCl_2) and titrated with tenth-normal sodium hydroxide, using methyl orange as indicator. The following reaction takes place in the cold:

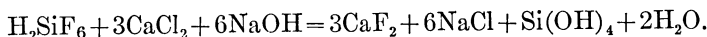

During the titration the solution remains clear, for the CaF_2 and the $\text{Si}(\text{OH})_4$ remain in colloidal solution. Phenolphthalein should not be used as indicator, as it is hard to decide upon the correct end point.

In the titration of salts of hydrofluosilicic acid, however, the titration must always be carried out with phenolphthalein as indicator:

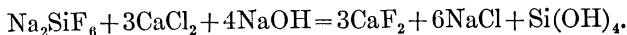

In this case

$$1000 \text{ c.c. of normal NaOH} = 47.08 \text{ gms. of Na}_2\text{SiF}_6.$$

Determination of Organic Acids.

Methyl orange cannot be used for the titration of organic acids, but either phenolphthalein or litmus may be employed. If carbonic acid is present at the same time, the titration is made in a hot solution (cf. p. 554). It is best to dilute the organic acid with water free from carbon dioxide, add phenolphthalein, and titrate with half-normal barium hydroxide in the cold.

To illustrate.—It is desired to analyze a sample of acetic anhydride. The only impurity that the distilled product is likely to contain is acetic acid, so that it is a question of determining the amount of acid and anhydride in the presence of one another. Such a problem can be solved only by an indirect analysis. The mixture is weighed out in a small glass bulb and then thrown into an accurately-measured amount of standard barium hydroxide solution. The latter is contained in a flask which is

* Ber., 39, 3693. This method has not been tested by the author.

connected with a return-flow condenser and at the top of the condenser a soda-lime tube is fitted. The contents of the flask are warmed gently until the oil has completely dissolved; it is thereby changed to acetic acid,

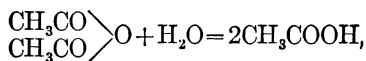

and the latter is neutralized by the alkali. After the reaction is complete, a drop of phenolphthaleïn is added and the solution is decolorized by the addition of a titrated acid. From the amount of the latter used, the excess of the alkali is known, and if this is deducted from the total amount of alkali in the flask, the amount necessary for the complete neutralization of the acetic acid, whether originally present as the free acid or in the form of its anhydride, can be calculated:

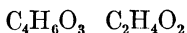

1. $x + y = p$ (original weight);
2. $mx + y = q$ (weight acetic acid after the action of water);

and from this x can be calculated,

$$x = \frac{1}{m-1} (q-p),$$

and in these equations $m = \frac{2\text{C}_2\text{H}_4\text{O}_2}{\text{C}_4\text{H}_6\text{O}_3} = \frac{120.06}{102.05} = 1.1765$ and

$$\frac{1}{m-1} = 5.665.$$

Example.—The absolutely clear preparation of acetic anhydride from a well-known firm gave the following results, 0.9665 gm. being taken for the analysis:

200 c.c. of barium hydroxide solution required 187.79 c.c. $\frac{\text{N}}{10}$ HCl;

200 c.c. of barium hydroxide + 0.9665 gm. of substance

required 6.03 c.c. $\frac{\text{N}}{10}$ HCl;

so that the 0.9665 gm. of substance was equivalent to 181.76 c.c.

$\frac{N}{10}$ HCl, and this amount of $\frac{N}{10}$ Ba(OH)₂ solution would have been required to neutralize it. This corresponds to

$$181.76 \times 0.006003 = 1.0911 \text{ gms. acetic acid} = q.$$

If, now the values of p and q are introduced in the previous equations, we obtain

$$x = 5.665(1.0911 - 0.9665) = 0.7059 \text{ gm. anhydride,}$$

and in per cent.

$$0.9665 : 0.7059 = 100 : x$$

$$x = 73.04 \text{ per cent. acetic anhydride.}$$

The preparation, therefore, contained

$$\text{Acetic anhydride} = 73.04 \text{ per cent.}$$

$$\text{Acetic acid} = \frac{26.96 \text{ per cent.}}{100.00 \text{ per cent.}}$$

Remark.—Acetic acid anhydride is also hydrolyzed by water at the ordinary temperature. If a weighed amount of the substance is shaken with water in a flask until no more drops of anhydride are to be recognized, and the acetic acid formed is then titrated with barium hydroxide, using phenolphthalein as indicator, correct results are obtained if the water used is entirely free from carbon dioxide. It is always safer, however, to carry out the determination as outlined above.

In some factories the analysis of acetic acid anhydride is carried out by the method of Menshutkin and Wasiljeff. This is based upon the fact that when acetic acid anhydride is treated with freshly distilled aniline, acetanilide is formed in accordance with the following equation.

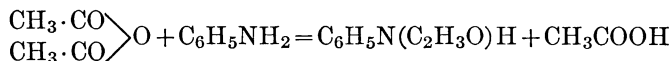

whereas acetic acid itself does not form acetanilide under the same conditions. Two or three grams of commercial acetic anhydride are shaken in a dry weighing beaker with from 4 to 6 c.c. of freshly distilled aniline. The anhydride immediately begins to combine with the aniline, liberating considerable heat. After cooling, the solidified contents of the weighing beaker are rinsed by means of absolute alcohol into an ordinary beaker, phenolphthalein is added and the total amount of acetic acid present titrated with half-normal alkali.

We have then

$$\begin{array}{r} \text{C}_4\text{H}_6\text{O}_3 \quad \text{C}_2\text{H}_4\text{O}_2 \\ x \quad + \quad y = p; \\ mx \quad + \quad y = q \text{ (acetic acid);} \end{array}$$

from which can be computed

$$x = \frac{p - q}{1 - m} = 2.428.$$

In this equation

$$m = \frac{\text{C}_2\text{H}_4\text{O}_2}{\text{C}_4\text{H}_6\text{O}_3} = \frac{60.03}{102.05} = 0.5882.$$

It is true that concordant results are obtained by this method, but they are much too high; in fact as much as 14 to 16 per cent. too high. This is due to the fact that although acetic acid itself does not react with aniline in the cold, it does react very readily when heated. When, therefore, a mixture of acetic anhydride and acetic acid are allowed to remain in contact with aniline, there is so much heat liberated from the reaction between the anhydride and the aniline that a part of the acetic acid itself reacts and takes part in the formation of acetanilide:

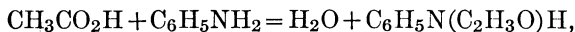

so that evidently too little acetic acid is found in the subsequent

titration and consequently too high values are obtained for the amount of anhydride present.

Determination of Sulphurous Acid.

For the determination of sulphurous acid by itself, the analysis is always accomplished, as recommended by Volhard, by an iodimetric process, i.e., it is oxidized to sulphuric acid. In many cases, however, it is necessary to titrate the sulphurous acid with alkali (cf. p. 577), and here the choice of an indicator is important, for the end-point is very different in the case of methyl orange from that obtained when phenolphthaleïn is used:

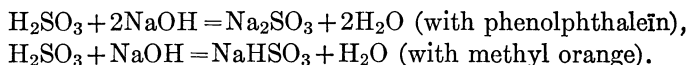

NaHSO_3 reacts acid toward phenolphthaleïn, but neutral toward methyl orange, so that twice as much alkali would be added in the first case. The most accurate results are obtained with the use of methyl orange, for the carbon dioxide which is almost always present does not exert much of an effect upon this indicator, whereas it does upon phenolphthaleïn.

Determination of Orthophosphoric Acid.

NaH_2PO_4 reacts acid toward phenolphthaleïn, and neutral toward methyl orange, while Na_2HPO_4 is neutral toward the former indicator and basic toward the latter.

Therefore, on titrating free phosphoric acid with alkali one of the following reactions will take place:

1. $\text{H}_3\text{PO}_4 + 2\text{NaOH} = \text{Na}_2\text{HPO}_4 + 2\text{H}_2\text{O}$ (phenolphthaleïn).
2. $\text{H}_3\text{PO}_4 + \text{NaOH} = \text{NaH}_2\text{PO}_4 + \text{H}_2\text{O}$ (methyl orange).

The first reaction is not sharp, because pure Na_2HPO_4 is dissociated to a slight extent, so that it becomes alkaline to phenolphthaleïn:

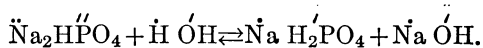

To prevent this hydrolysis, the titration is best effected in a cold, concentrated solution containing sodium chloride.

Alkalimetric Determination of Phosphorus in Iron and Steel *

1000 c.c. normal NaOH = 1.348 gm. P.

The phosphorus is precipitated in a 2 gm. sample with ammonium molybdate according to p. 437, † filtered, washed with 1 per cent. nitric acid and then with 1 per cent. potassium nitrate solution until the washings no longer react acid. The filter and precipitate are then transferred back to the Erlenmeyer flask in which the precipitation took place, covered with an excess of tenth-normal NaOH (T c.c.), stirred until solution is complete, and then the excess of alkali titrated with tenth-normal nitric acid, (t c.c.) using phenolphthalein as indicator.

The reactions taking place are as follows:

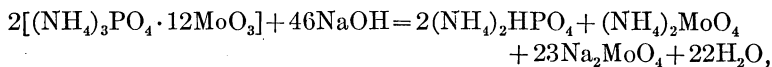

from which it is clear that 46 gms. mols. of NaOH are equivalent to 2 gm. atoms of P and 1 c.c. of the tenth-normal NaOH = 0.0001348 gm. P.

Since the precipitate was produced from 2 gm. steel, and T c.c. of NaOH and t c.c. of HNO₃ were used, the percentage of phosphorus is

$$\frac{(T-t) \times 0.01348}{2} = \% \text{P.}$$

Remark.—To obtain accurate results, it is advisable to determine the percentage of phosphorus in a steel gravimetrically, then to standardize the alkali against this steel, carrying out the titration exactly as described above.

Determination of Boric Acid.

Free boric acid has no action upon methyl orange, consequently alkali borates may be titrated with hydrochloric and nitric acids, using this indicator; with sulphuric acid the results

* See Blair, Analysis of Iron and Steel. The method was proposed by I. O. Handy.

† See Appendix I for another method of precipitating phosphoric acid.

are not as satisfactory, for there is in this case no sharp color change. If phenolphthalein is used as the indicator, the red color fades gradually and the end point cannot be determined with certainty. If, on the other hand, sodium hydroxide is slowly run into an aqueous solution of boric acid containing phenolphthalein, after some time a pale-pink color is noticeable which becomes deeper on the addition of more alkali. The first pink color is formed before all of the boric acid has been neutralized, for sodium borate is perceptibly hydrolyzed. Free boric acid cannot be titrated by itself, but if, as proposed by Jorgensen,* a sufficient amount of glycerol† (or mannitol‡) is added to the solution, the hydrolysis is prevented, so that when 1 mol. of NaOH is present for 1 mol. of H_3BO_3 the solution suddenly changes from colorless to red; probably a stronger acid is formed by the addition of the glycerol, the glyceryl-boric acid $(C_3H_5O_2OH)B(OH)$.

If the solution does not contain sufficient glycerol the color change takes place too soon, as can be shown by the addition of more glycerol. If the red color disappears on adding the latter, more alkali is added until it reappears. The right end-point is reached when the red color no longer disappears on the addition of glycerol. Inasmuch as commercial glycerol reacts acid, it must be just neutralized with alkali before being used for this determination. Furthermore, in order to obtain accurate results it is necessary that the solutions should be absolutely free from carbonate.

Application. Determination of Boric Acid in an Alkali Borate Free from Carbonate.§

About 30 gms. of the borate are dissolved in water free from carbon dioxide, diluted to 1 liter, and the total alkali is determined in an aliquot part by titration with $\frac{N}{2}$ hydrochloric acid, using methyl orange as an indicator. A fresh portion of the borate is

* Zeitschr. f. Nahrungsm. IX, p. 389, and Zeitschr. f. angew. Ch., 1897, F. 5.

† Zeitschr. f. angew. Ch., 1896, p. 549.

‡ Jones, Am. J. Sci. [4] 7, 147 (1899).

§ M. Hönig and G. Spitz, Zeitschr. f. angew. Ch., 1896, p. 549.

taken and exactly neutralized by the amount of hydrochloric acid found necessary by the previous titration; by this means the solution will contain free boric acid. After adding about 50 c.c. of glycerol for each 1.5 gms. of the borate, the solution is titrated with $\frac{N}{10}$ sodium hydroxide, using phenolphthaleïn as indicator.

After the end-point is reached, 10 c.c. more of glycerol are added, and this usually causes the solution to become colorless. The end-point with sodium hydroxide is again obtained and the process repeated until finally the addition of glycerol causes no further action upon the end-point.

If the borate contained carbonate, the portion taken for analysis is neutralized with acid as before, then boiled for a few minutes, taking the precaution of connecting the flask containing the solution with a return-flow condenser.* After the carbon dioxide is expelled, the sides of the condenser are washed down with water and the titration with sodium hydroxide made as before.†

For the

Determination of Boric Acid in Insoluble Silicates.

see E. T. Wherry and W. H. Chapin, J. Am. Chem. Soc., 30, 1687 (1908).

Determination of Carbonic Acid.

(a) Determination of Free Carbonic Acid.

To determine the amount of free carbonic acid present in a dilute aqueous solution, an excess of titrated barium hydroxide solution is added, and the excess is determined by means of $\frac{N}{10}$ HCl, using phenolphthaleïn as an indicator:

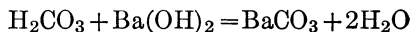

$$1 \text{ c.c. } \frac{N}{10} \text{ HCl} = 0.0022 \text{ gm. CO}_2.$$

* The condenser serves to keep back any boric acid escaping with the steam.

† Instead of the glycerol, about one gram of mannitol may be used to advantage.

(b) Determination of Carbon Dioxide Present as Bicarbonate.

The solution is titrated with $\frac{N}{10}$ HCl in the presence of methyl orange:

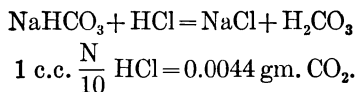
**(c) Determination of Carbon Dioxide Present as Carbonate.**

The titration is effected with $\frac{N}{10}$ HCl and methyl orange:*

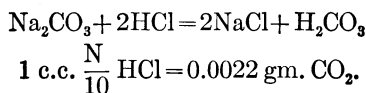
**(d) Determination of Free Carbonic Acid in the Presence of Bicarbonate.**

One portion is titrated with $\frac{N}{10}$ HCl, using methyl orange as indicator, and the amount of bicarbonate is determined as under (b).

A second portion is treated with an excess of barium chloride,† then with an excess of barium hydroxide, and the excess of the latter titrated back with HCl, using phenolphthaleïn as indicator. If the amount of $\frac{N}{10}$ acid used for the first titration is deducted from the amount of $\frac{N}{10}$ barium hydroxide solution found to be necessary by the last titration, the difference multiplied by 0.0022 will give the amount of free carbonic acid.‡

* Alkaline-earth carbonates are dissolved in an excess of standard acid and the excess titrated back with standard alkali.

† The addition of barium chloride is only necessary when free carbonic acid is titrated in the presence of alkali bicarbonates. Without it free alkali would then be formed: $\text{NaHCO}_3 + \text{Ba}(\text{OH})_2 = \text{BaCO}_3 + \text{H}_2\text{O} + \text{NaOH}$.

‡ This method cannot be used when magnesium salts are present.

(e) *Determination of Bicarbonate in the Presence of Carbonate.*
Method of C. Winkler.

In one portion the total alkalinity is determined by titration with $\frac{N}{10}$ HCl, using methyl orange as indicator. This requires T c.c. of $\frac{N}{10}$ HCl.

In a second portion the bicarbonate is determined by adding an excess of $\frac{N}{10}$ NaOH, then neutral barium chloride solution, and afterward titrating the excess of the former with phenolphthaleïn and $\frac{N}{10}$ HCl. We will assume that for this purpose T_1 c.c. $\frac{N}{10}$ NaOH and t c.c. $\frac{N}{10}$ HCl were used, then evidently $(T_1 - t)$ c.c. $\frac{N}{10}$ NaOH were necessary to convert the bicarbonate into carbonate:

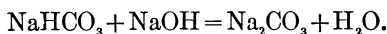

1NaOH corresponds, consequently, to 1CO_2 , or

$$1 \text{ c.c. } \frac{N}{10} \text{ NaOH} = 0.0044 \text{ gm. CO}_2,$$

and therefore $(T_1 - t) \cdot 0.0044 = \text{CO}_2$ as bicarbonate.

For the decomposition of the normal carbonate

$$T - (T_1 - t) = (T + t - T_1) \text{ c.c. } \frac{N}{10} \text{ HCl}$$

were necessary, and from the equation

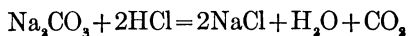

it is evident that

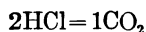

and

$$1 \text{ c.c. } \frac{N}{10} \text{ HCl} = 0.0022 \text{ gm. CO}_2.$$

The carbon dioxide as carbonate = $(T + t - T_1) \cdot 0.0022 \text{ gm.}$

Remark.—It has been proposed to determine volumetrically the free and bicarbonate carbonic acid in drinking and mineral waters; with the former accurate results can be obtained, but with the latter this is not the case. In the determination of the total alkalinity not only the bicarbonate but also the ever-present silicate and borate are likewise determined, so that this in many cases causes considerable error in the analysis of mineral waters. Thus in analyzing a sample of mineral water containing in reality 4.63 gms. of carbonic acid as bicarbonate per kilogram, the titration showed 5.42 gms., a difference of 0.61 gm. CO_2 !

Determination of Carbonic Acid in the Air. Method of Pettenkofer.

Principle.—A large, measured volume of air is treated with an excess of titrated barium hydroxide solution whereby the carbon dioxide is quantitatively absorbed, forming insoluble barium carbonate. Phenolphthalein is added, and the excess of barium hydroxide is determined by titration with hydrochloric acid until the solution is colorless. From the amount of alkali used to absorb the carbon dioxide, the amount of the latter is calculated, 1 c.c. of normal alkali = 0.22 gm. CO_2 = 13 c.c. of CO_2 gas at 0° and 760 mm. pressure.

Requirements.—1. A calibrated bottle of 5 liters capacity.

2. Standard solutions of barium hydroxide and hydrochloric acid. The acid is prepared so that 1 c.c. = 0.25 c.c. CO_2 at 0° C. and 760 mm. pressure; this is accomplished by diluting 224.7 c.c. $\frac{\text{N}}{10}$ hydrochloric acid to 1 liter. The barium hydroxide solution should be of about the same strength.

Procedure.—The bottle, with its capacity etched upon it, is placed in the space from which the air is to be taken, and by means of a bellows, the mouth of which is connected with a piece of rubber tubing, the air in the bottle is changed; about 100 strokes are made with the bellows. The bottle is then stoppered with a rubber cap, and at the same time the temperature and barometer readings are noted.

By means of a pipette, 100 c.c. of barium hydroxide solution are run into the bottle, the rubber cap replaced upon it, and the solution is gently shaken back and forth in the flask for fifteen minutes. The turbid liquid is then poured into a dry flask, 25 c.c. are pipetted out, phenolphthaleïn is added, and hydrochloric acid slowly run in with constant stirring until the solution is colorless. This requires n c.c., so that for the 100 c.c. of alkali solution, $4 \times n$ c.c. would be necessary. The strength of the barium hydroxide in terms of acid is now accurately determined; 25 c.c. of barium hydroxide require N c.c. of the standard hydrochloric acid, or 100 c.c. would neutralize $4 \times N$ c.c. of acid.

Calculation.—Assume the contents of the bottle to be V c.c. at t° C. and B mm. pressure. By the introduction of 100 c.c. barium hydroxide solution the same volume of air was replaced, so that the amount of air taken for analysis amounts to $(V - 100)$ c.c. at t° C. and B mm. At 0° C. and 760 mm. pressure the volume is

$$V_0 = \frac{(V - 100)B}{760(1 + \alpha \cdot t)}$$

100 c.c. of barium hydroxide solution require $4N$ c.c. HCl, while 100 c.c. of the alkali after treatment with V_0 c.c. of air require $4n$ c.c. of the acid and this corresponds to $4(N - n) \cdot 0.25 = (N - n)$ c.c. CO_2 at 0° C. and 760 mm. pressure.

The amount of CO_2 present in 1 liter of air measure at standard conditions amounts to

$$V_0 : (N - n) = 1000 : x$$

$$x = \frac{1000 \cdot (N - n)}{V_0} \text{ gms. CO}_2.$$

Persulphuric Acid.

$$1000 \text{ c.c. } \frac{N}{10} \text{ Potassium Hydroxide}$$

$$= \frac{K_2S_2O_8}{20} = \frac{270.34}{20} = 13.517 \text{ gms. } K_2S_2O_8.$$

If an aqueous solution of either potassium, sodium, or barium persulphate is boiled for some time, the salt is decomposed in accordance with the equation:

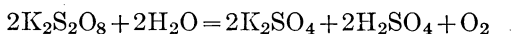

into neutral sulphate and free sulphuric acid. The latter can be titrated with tenth-normal potassium hydroxide solution.

Procedure.—About 0.25 gm. of the persulphate is placed in an Erlenmeyer flask of Jena glass, dissolved in about 200 c.c. of water, and the solution boiled for twenty minutes. It is then cooled, methyl orange added, and the solution titrated with tenth-normal potassium hydroxide. Or, an excess of the alkali may be added and the amount of excess titrated with tenth-normal acid.

The results correspond with those obtained by the ferrous sulphate method (cf. p. 629) provided the persulphate is not contaminated with potassium bisulphate.

Remark.—Ammonium persulphate cannot be analyzed by the above method because when a solution of this salt is boiled, two reactions take place. The principal reaction, to be sure, is

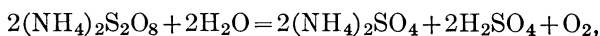

but the oxygen is evolved to some extent in the form of ozone and the latter oxidizes a part of the nitrogen, so that besides sulphuric acid, the solution will contain more or less nitric acid.



II. OXIDATION AND REDUCTION METHODS.

All processes considered under this heading are those in which the substance analyzed is either oxidized or reduced by means of the solution with which the titration is made. As a standard for determining equivalent weights the oxidation of hydrogen by oxygen has been taken; 1 gm.-atom of hydrogen is equivalent to $\frac{1}{2}$ gm.-atom of oxygen. When hydrogen is oxidized it is changed from the neutral condition to that of a positive valence (or polarity) of one and oxygen is reduced from the neutral condition to negative valence (or polarity) or two. In this, and all other cases, the equivalent weight of the element used in an oxidation-reduction reaction is the atomic weight divided by the change in polarity. When an atom in any complex molecule is subjected to a change in polarity (oxidized or reduced) the equivalent weight of the molecule is the gram-molecular weight divided by the change in polarity of the oxidized or reduced element. If more than 1 atom of the reactive element is present in the molecule, the molecular weight is divided by the total change in polarity, i.e., by the change in polarity multiplied by the number of atoms undergoing such change (cf. p. 531).

OXIDATION METHODS.

A. The Permanganate Methods.

When potassium permanganate acts as an oxidizing agent in distinctly acid solution, the manganese is reduced from a valence of +7 to +2, corresponding to a loss of five charges in polarity. A normal solution of permanganate, therefore, contains one-fifth mole of $\text{KMnO}_4 = 31.61$ gms.

For most oxidation analyses $\frac{N}{10}$ and rarely $\frac{N}{2}$ solutions are used.

The Preparation of $\frac{N}{10}$ Potassium Permanganate Solution was described on p. 90.

Standardization of Permanganate Solution.1. *Against Sodium Oxalate* (Sörensen).*

1000 c.c. of normal permanganate solution = 67.00 gms. $\text{Na}_2\text{C}_2\text{O}_4$.

Sodium oxalate can be purchased in a very pure condition. The traces of moisture present may be expelled by heating the oxalate for two hours at 130° and cooling in a desiccator; but for ordinary work this is usually unnecessary.

A weighed amount of sodium oxalate is dissolved in 200 c.c. of distilled water at 70° , about 20 c.c. of double-normal sulphuric acid are added, and the hot solution titrated with permanganate. At the start the titration should proceed very slowly, waiting after the addition of each drop until the color has disappeared before adding more permanganate

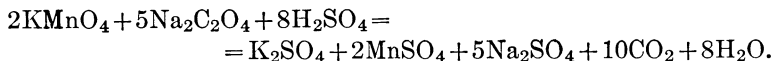

The purity of the sodium oxalate may be tested by heating a weighed sample in a covered platinum crucible for thirty minutes over a small flame, so that the bottom of the crucible is barely red. It is best to use an alcohol lamp or else insert the crucible in a disk of asbestos as in a sulphur determination. Otherwise the sulphur in the illuminating gas may cause the formation of some sodium sulphate in the crucible. By the heating the oxalate is converted quantitatively into carbonate, but there is a separation of some carbon which should be removed for the most accurate work. This may be accomplished by heating the contents of the crucible to a much higher temperature with free access of air, or more readily by adding a few cubic centimeters of water, evaporating the solution to dryness on the water bath, and then very carefully heating the crucible over a free flame. In about ten minutes the carbon will all disappear without the carbonate being melted. The crucible is then allowed to cool, its contents dissolved in hot

* *Z. anal. Chem.*, **42**, 352, 512 (1903); **45**, 272 (1906).

water, the crucible and cover thoroughly washed, and the cold solution titrated with tenth-normal hydrochloric acid, using methyl orange as indicator.

1000 c.c. tenth-normal hydrochloric acid = 6.700 gms. $\text{Na}_2\text{C}_2\text{O}_4$.

Remark.—Sodium oxalate crystallizes without water of crystallization, is not hygroscopic, and is especially suited for the standardization of permanganate solutions. Sørensen, in fact, has strongly recommended this substance as a standard for acidimetry, although it has no advantage over the standardization by means of sodium carbonate. The titration of the carbonate may be carried out with methyl orange as an indicator, but Sørensen recommends phenolphthaleïn as somewhat more reliable.

2. Against Oxalic Acid.

Tenth-normal oxalic acid solution is excellent for the standardization of a permanganate solution. By means of a pipette 25 c.c. are measured into a beaker, 10 c.c. of dilute sulphuric acid (1:4) are added, the solution is diluted with water at about 70° C. to a volume of 200 c.c., and the permanganate is run into it, with constant stirring, from a glass-stoppered burette. At first the solution is colored red for several seconds, then it becomes colorless but after the reaction is once started the permanganate is rapidly decolorized until an excess is present. The permanent pink color is imparted to the solution by the permanganate as soon as all the oxalic acid is oxidized; this is taken as the end-point.

The oxidation is expressed by the following equation:

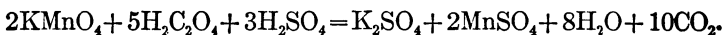

Two positive charges are required to oxidize the C_2O_4^- ion to CO_2 gas.

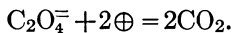

It is evident, therefore, that the equivalent weight of oxalic acid is $\frac{1}{2}$ mole = 63.03 gms. whether the reaction is one of the hydrogen ions in oxalic acid or whether it is the oxidation of the oxalate anion. Using a normal solution as the unit of concentration, the strength of oxalic acid is the same in both instances.

If for the oxidation of 25 c.c. of tenth-normal oxalic acid solution, 24.3 c.c. of permanganate were required, then 1 c.c. of

permanganate = $\frac{25 \times 0.1}{24.3} = 0.1029$ c.c. of a normal solution. The permanganate solution is 0.1029-normal. It is not necessary that the oxalic acid solution should be exactly tenth-normal.

Instead of using an oxalic acid solution, some pure oxalic acid crystals, $\text{H}_2\text{C}_2\text{O}_4 \cdot 2\text{H}_2\text{O}$, may be taken. [For a tenth-normal solution about 0.2 gm. of the oxalic acid should be weighed out to the nearest tenth of a milligram. Then if n c.c. of permanganate are used for titrating p -gm. of oxalic acid, and 0.063 the milli-equivalent of oxalic acid (1 c.c. of a normal solution reacts with milli-equivalent in grams of the reagent) the permanganate is

$$\frac{p}{n \times .063} \text{ normal.}$$

Besides using oxalic acid itself, various oxalates such as KHC_2O_4 , $\text{KHC}_2\text{O}_4 \cdot \text{H}_2\text{C}_2\text{O}_4 \cdot 2\text{H}_2\text{O}$, MnC_2O_4 , etc., have been recommended. The method of procedure is practically the same in each case. It is interesting to note that the equivalent weights of $\text{H}_2\text{C}_2\text{O}_4 \cdot 2\text{H}_2\text{O}$, KHC_2O_4 and $\text{KHC}_2\text{O}_4 \cdot \text{H}_2\text{C}_2\text{O}_4 \cdot 2\text{H}_2\text{O}$ are 63.03, 64.11, and 63.57 respectively when used as reducing agents and 63.03, 128.2 and 84.76 when used as acids.

It was once the general practice to express the concentration of permanganate in terms of "available oxygen" or in terms of metallic iron; the latter, it was assumed, was first dissolved in acid and oxidized from the ferrous to the ferric condition by the permanganate. If the normal concentration of the permanganate is multiplied by 0.008 the "available oxygen" per cubic centimeter will be obtained and if the normal concentration (sometimes called normality) is multiplied by 0.0559, the "iron value" of 1 c.c. permanganate will be obtained.

Remark.—Against the use of oxalic acid solution for the standardization of a permanganate solution is the fact that the concentration of the aqueous solution is not permanent; for this reason, E. Riegler* proposed the addition of 50 c.c. of concentrated sulphuric acid to each liter of the oxalic acid, by which means the solution can be kept unchanged for a much longer length of time. That this is the case is shown by the following

* Z. anal. Chem., 1896, p. 522.

experiments: A solution of oxalic acid in water was prepared, and also one in dilute sulphuric acid. Both solutions were titrated on the same day with permanganate solution which had been standardized against electrolytic iron. At the end of eight months the same solutions were titrated against a freshly standardized permanganate solution, with the following results:

	Aqueous Oxalic Acid.	Oxalic Acid containing Sulphuric Acid.
Freshly-prepared.	1000 c.c. = 1000.6 c.c. $\frac{N}{10}$ sol.	1000 c.c. = 1002.5 c.c. $\frac{N}{10}$ sol.
After 8 months...	1000 c.c. = 994.9 c.c. " "	1000 c.c. = 1001.8 " " "

At the end of eight months, therefore, the aqueous solution had depreciated 0.56 per cent. in strength, while the solution containing the sulphuric acid had only weakened to an extent of 0.12 per cent. of its original concentration.

From this it is evident that a solution of oxalic acid containing sulphuric acid can be used for the standardization of a permanganate solution, provided the former has not stood more than eight months since it was prepared. The use of old aqueous solutions of oxalic acid is to be discouraged.

3. Against Metallic Iron.

It has been a favorite practice to standardize permanganate solutions against iron wire. The wire, however, is never absolutely pure, and there is a chance of the impurities reducing permanganate so that the actual iron content of the wire does not suffice to show exactly how much oxidizing agent it will need. Classen,* therefore, has recommended that pure iron be prepared by the electrolysis of ferrous ammonium oxalate. This iron is dissolved in dilute sulphuric acid out of contact with the air and the solution titrated with permanganate (cf. p. 93).

The standardization of a potassium permanganate solution can be correctly accomplished by means of iron wire, provided the *apparent iron content* of the wire has been determined by a comparison of the values obtained in a titration with a standardization by either electrolytic iron or sodium oxalate. Every time a new supply of iron wire is purchased, the comparison should be made.

* Classen-Hall, Quantitative Analysis by Electrolysis.

Determination of the Apparent Iron Value of Iron Wire.—The wire is cleaned as described on p. 98, and a weighed portion of about 0.2 gm. is introduced into a flask of not more than 250 c.c. capacity as shown in Fig. 89. The air is displaced by the introduction of a stream of carbon dioxide, which has passed through a bottle containing water and another containing copper sulphate solution (cf. p. 93, foot-note); the wire is then dissolved in 55 c.c.

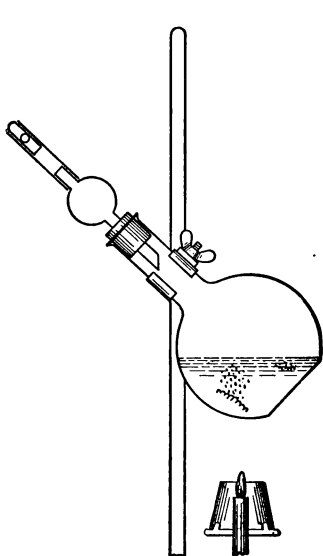

FIG. 89.

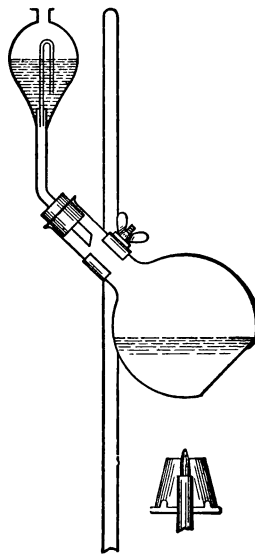

FIG. 90.

of dilute sulphuric acid (1 part concentrated acid to 10 of water). During the solution of the wire, the flask is supported somewhat as shown in the drawing, and is closed by a rubber stopper which carries a bulb tube connected with a Bunsen valve.* The con-

* A Bunsen valve consists of a short piece of rubber tubing with a cut along a few centimeters of one side, and the outer end of the tubing is closed by a glass rod. This valve prevents the entrance of air from without. A flask larger than 250 c.c. capacity is likely to be so thin as to break during the cooling of the iron solution. In Fig. 80a, instead of using a glass rod at the end of the valve, a glass tube is used which is sealed at one end, and has a hole on one side. This tube serves to prevent the collapse of the rubber tubing at the place where the slit is formed.

tents of the flask are heated by means of a low flame until the wire has all dissolved, after which the solution is boiled gently for a short time. It is then allowed to cool, the stopper is removed, and the permanganate added until a color is obtained which is permanent for thirty seconds.

Instead of using a Bunsen valve, the Contat-Göckel valve may be used as shown in Fig. 90. The funnel contains a cold, saturated solution of sodium bicarbonate, through which the hydrogen from the flask passes. When the flame is removed sodium bicarbonate solution is drawn into the flask, and this causes the evolution of carbon dioxide, which prevents the entrance of more of the solution.

S. Christie, by following the above procedure, found the apparent iron content of a wire to be 99.985 per cent., and Dr. Schudel found 100.21 for another wire.

It must be mentioned, however, that the apparent iron value varies considerably with the way in which the solution of the wire is effected. If the volume of the liquid is large (cf. p. 96), there is more chance of hydrocarbons remaining in solution, and the same is true if the solution is not boiled as in the above direction, but merely heated upon the water bath.

Remarks Concerning the Standardization by Means of Electrolytic Iron.—The objection has been raised that electrolytic iron is contaminated with hydrocarbons. According to Avery and Benton Dales,* the iron obtained by the electrolysis of ferrous ammonium oxalate contains from 0.2 to 0.4 per cent. carbon on an average; according to Skrabal † considerably more. Verwer and Groll, ‡ however, assert that electrolytic iron contains no carbon provided the bath still contains an excess of iron at the end of the electrolysis. Christie has carried out extensive experiments in the author's laboratory and found that the electrolytic iron prepared by the Classen method does often contain carbon, but the amount is so small that it may be disregarded. Christie, furthermore, standardized a solution of permanganate by four different methods and obtained the following values:

* Ber., 32, 64 (1899).

† Z. anal. Chem., 42, 395 (1903).

‡ Ber., 32, 806 (1899). See also H. Verwer: Chem. Ztg., 25, 792 (1901).

Against.	Value 1 c.c. in Terms of Oxygen.	
Electrolytic iron	0.0007972	0.0007960
Iodine	0.0007977	0.0007982
Oxalic acid	0.0007978	0.0007967
Sodium oxalate	0.0007970	0.0007975

4. *Against Sodium Thiosulphate.*

See Iodimetry.

5. *Against Hydrogen Peroxide.*

See Gasometric Methods.

Permanence of Potassium Permanganate Solutions.

As mentioned on p. 90, a permanganate solution will keep indefinitely, provided it is kept free from dust and reducing vapors. In order to test the permanence of such a solution,* it was standardized against electrolytic iron and after eight months it was again tested.† It had lost only 0.17 per cent. of its original value and could be used for all ordinary analyses. For very accurate work, however, it is advisable to standardize the solution frequently.

USES OF PERMANGANATE SOLUTION.

i. Determination of Iron (Margueritte 1846).

$$1 \text{ c.c. } \frac{N}{10} \text{ KMnO}_4 \text{ corresponds to } \begin{cases} 0.005585 \text{ gm. Fe} \\ 0.007185 \text{ gm. FeO} \\ 0.007985 \text{ gm. Fe}_2\text{O}_3 \end{cases}$$

In this determination the iron is oxidized from the ferrous to the ferric condition:



The solution of the ferrous salt is strongly acidified with sulphuric acid (about 5 c.c. of concentrated sulphuric acid should be present for each 100 c.c. of the solution), diluted with boiled water to a volume of 400 to 500 c.c., and titrated in the cold by

* The solution was already three months old.

† In June, 1899, 1 c.c. of the KMnO_4 solution = 0.0054853 gm. Fe; in March, 1900, 1 c.c. of the KMnO_4 solution = 0.0054761 gm. Fe. See also Morse, Hopkins and Walker, *Am. Chem. Jour.*, 18, 401.

the addition of potassium permanganate from a glass-stoppered burette until a permanent pink color is obtained. If the permanganate solution is tenth-normal, the number of cubic centimeters used multiplied by 0.005585, 0.007185, or 0.007985 will give respectively the amounts of iron, ferrous or ferric oxide.

This determination affords very accurate results and is unquestionably one of the best methods for determining iron.

Remark.—The titration of iron in hydrochloric acid solution gives high results unless particular precautions are taken. If dilute permanganate solution is allowed to run into a cold dilute solution of ferrous chloride containing hydrochloric acid, the former is decolorized and the iron is oxidized, but there is a noticeable evolution of chlorine.* More permanganate is used up than is necessary to oxidize the ferrous salt to the ferric condition.

If, however, permanganate is run into cold, dilute hydrochloric acid, in the absence of ferrous salt, there is no evolution of chlorine. Furthermore, the presence of a ferric salt does not cause evolution of chlorine. The chlorine, therefore, is not a result of the direct action of the permanganate upon the hydrochloric acid, but is probably due to the oxidation of the ferrous ion to an unstable state of oxidation corresponding to a perchloride, a peroxide, ferric acid or perferric acid.

When permanganate is run into a dilute hydrochloric acid solution containing ferrous chloride and considerable manganous salt, the ferrous iron is quantitatively oxidized to ferric iron and there is *no evolution of chlorine*. This was shown by Kessler † in 1863 and by Zimmermann ‡ in 1881. It has since been confirmed by many other chemists.§

This can be explained as follows: Permanganate ions react with manganous ions to form, as Volhard || proved, quadrivalent manganese. In this state of oxidation, manganese is unstable in acid solution, but it is reduced more readily by ferrous ions than by chlorine ions.

* Löwenthal and Lenssen, *Z. anal. Chem.*, **1863**, 329.

† *Pogg. Ann.*, **118**, 779, and **119**, 225.

‡ *Ber.*, **14**, 779, and *Ann. Chem. Pharm.*, **213**, 302.

§ For example, J. A. Friend, *J. Chem. Soc.*, **95**, 1228 (1909). C. C. Jones and J. H. Jeffery, *The Analyst*, **34**, 306 (1909).

|| *Ann. Chem. Pharm.*, **198**, 337.

Zimmerman * suspected, and Manchot's experiments † confirm this view, that iron like manganese has a tendency to form unstable compounds as primary oxidation products. If such a compound is formed in the presence of manganese ions, the iron will give up its excess charge to the manganese rather than to chlorine ions, provided a sufficient quantity of manganous ions are present.

According to Manchot there is a tendency in all oxidations to form an unstable compound as the primary oxidation product. When hydrogen burns in air, a little hydrogen peroxide is formed; when sodium burns, sodium peroxide results. In most cases, these primary products are unstable and cannot be isolated because of the readiness with which they are reduced to a more stable condition. When an *acceptor* ‡ is present it will take up the excess charge which is lost when the primary product is reduced; in aqueous solutions in the absence of any other acceptor, free oxygen is evolved.

According to the method of oxidation, iron tends to form different primary states of oxidation. In the direct oxidation of iron by oxygen, the primary oxide appears to be FeO_2 ; in the oxidation by means of permanganate, chromic acid or hydrogen peroxide, the primary oxidation product to contain iron with a valence of 5, whereas iron with a valence of 6 is probably formed if hypochlorous acid is the oxidizer.

The oxidation of ferrous oxide to ferric oxide, therefore, does not take place so simply as usually imagined; a part, at least, of the former oxide is converted into FeO_2 and this turns round and reacts with some of the unchanged ferrous oxide, which plays the part of an acceptor;

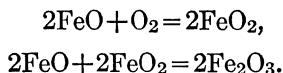

* Ber., 11, 779, and Ann. Chem. Pharm., 213, 302.

† Ann. Chem. Pharm., 325, 105 (1902).

‡ An *acceptor* is a substance which is not oxidized by oxygen alone, but can be thus oxidized by the aid of some other substance present called an *auto-oxidator*. A substance which tends to be peroxidized may play the part of an acceptor. Cf. Engler, Ber., 33, 1097 (1900).

Potassium permanganate causes the formation of quinquevalent iron. If sufficient manganese ions are present, these play the part of acceptor, but otherwise, in hydrochloric acid solution, some chlorine is formed:

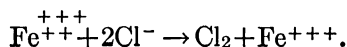
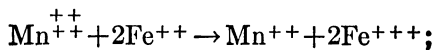
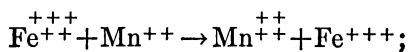
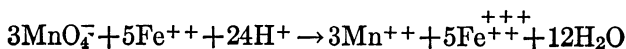

The action of the manganous sulphate is partly to regulate the reaction between ferrous and permanganate ions, for, according to Volhard, the manganese tends to react with permanganate ions, thus slowing down the reaction between permanganate and ferrous ions. The quadrivalent manganese formed by the action of permanganate on manganous ions, at once reacts with ferrous ions; the manganous ions also act as acceptor toward any iron oxidized above the trivalent state. In both cases it is essential that manganese peroxide does not react with hydrochloric acid very rapidly, and it is necessary, too, that the amount of manganous salt shall greatly exceed the amount of iron present.

Zimmermann suggested a similar explanation, but it seemed to meet with but little approval, so that the hypothesis of Wagner* was quite generally adopted. The latter claimed that the excess of permanganate required for the titration of ferrous chloride in the absence of manganous sulphate was due to the intermediate formation and rapid oxidation of a ferrous-hydrochloric acid, $\text{FeCl}_2 \cdot 2\text{HCl}$.

[Manchot's explanation, however, seems to be the better one.

Although it is possible, then, to titrate iron in hydrochloric acid solutions in the presence of manganous sulphate, the method possesses the disadvantage that the end-point cannot be seen so distinctly as when no chloride is present, since ferric chloride forms a much more yellow solution than does ferric sulphate.

* Zeitschr. f. physikal. Chem., 28, 33.

This difficulty can be overcome by the addition of phosphoric acid, as suggested by C. Reinhardt.*

TITRATION OF FERROUS SALTS IN HYDROCHLORIC ACID SOLUTION.
METHOD OF ZIMMERMANN-REINHARDT.

From 20 to 25 c.c. of the manganese sulphate solution † prepared as described below are added to the solution, and after diluting with boiled water to a volume of 500 c.c. it is titrated with potassium permanganate which is added so slowly that the drops can be counted. Care is taken toward the last not to add a drop of permanganate until the color of the preceding one has disappeared.

The manganous sulphate solution is prepared as follows: 67 gms. of crystallized manganous sulphate ($\text{MnSO}_4 + 4\text{H}_2\text{O}$) are dissolved in 500 to 600 c.c. of water, 138 c.c. of phosphoric acid (of specific gravity 1.7) and 130 c.c. of concentrated sulphuric acid (sp. gr. 1.82) are added, and the mixture is diluted to 1 liter.

If the iron is present as ferric salt, it must be reduced completely to the ferrous condition before it can be titrated with potassium permanganate.

THE REDUCTION OF FERRIC SALTS TO FERROUS SALTS

can be accomplished in a number of different ways.

1. *By Hydrogen Sulphide.*

This reduction has already been described on page 99.

2. *By Sulphur Dioxide.*

The solution containing the ferric salt is neutralized with sodium carbonate, ‡ an excess of sulphurous acid is added, the solution boiled, and a current of carbon dioxide is passed

* Stahl und Eisen, 1884, p. 709, and Chem. Ztg., 13, 323

† It is well to add one cubic centimeter of manganese sulphate for each cubic centimeter of HCl (sp. gr. 1.12) present. Cf. J. A. Friend or Jones and Jeffery, *loc. cit.*

‡ Ferric salts are not completely reduced by sulphurous acid in the presence of considerable hydrochloric or sulphuric acid.

through it until the excess of the reagent is completely removed.* The reduced solution is then cooled in an atmosphere of carbon dioxide and titrated.

3. By Metals.

The acid solution of the ferric salt, contained in a small flask fitted with a Bunsen valve, is reduced by heating on the water-bath with the addition of small pieces of chemically-pure zinc until the solution is completely colorless and a drop of it, removed by means of a piece of capillary tubing, will no longer give any color with potassium sulphocyanate solution. After cooling, the solution is poured through a funnel containing a platinum cone (no paper), and the undissolved zinc remaining in the funnel is washed several times with boiled water.†

Remark.—Since zinc often contains iron, a blank experiment must be made by dissolving 3 to 5 gms. in the same way and titrating the solution with permanganate. If iron is present, as shown by the fact that a measurable amount of potassium permanganate is decolorized, the reduction of the ferric salt must be effected by means of a weighed amount of zinc and a correction made for the iron. It is self-evident that in this case the titration must not take place until all of the zinc has dissolved. Instead of zinc, cadmium and aluminium are frequently used.

Remark.—Against this method objections can be raised. In the first place, the fact that a foreign metal is introduced into the solution is in many cases unfortunate. Furthermore, by means of zinc, titanous acid is reduced to Ti_2O_3 , only to be oxidized again by the permanganate solution, so that more permanganate solution will then be required than corresponds to the amount of iron present. By means of H_2S or SO_2 , titanous acid is not reduced and there is no foreign metal introduced into the solution. Con-

* It is not advisable to depend upon the sense of smell. The escaping gas is tested by passing it through dilute sulphuric acid containing a few drops of $\frac{N}{10}$ $KMnO_4$ solution. If the latter is not decolorized at the end of two or three minutes, the excess of sulphurous acid has been removed.

† The reduction by means of zinc may be satisfactorily accomplished with a "Jones reductor." Cf. Fig. 91, p. 637.

sequently, for accurate mineral analyses, it is necessary to use one of these methods, and in fact the reduction by means of hydrogen sulphide is to be preferred. By means of the latter the ferric salt is completely reduced, independent of how little or how much free acid is present in the solution; again, any metals of the hydrogen sulphide group are precipitated at the same time; while finally it is easy to recognize the fact that the excess of the gas has been removed by the use of the sensitive lead acetate paper test.

4. *By Stannous Chloride.*

This method proposed by Zimmermann and Reinhardt* is especially suited for metallurgical purposes, because it can be accomplished most rapidly.

Principle.—The method depends upon the fact that ferric chloride in hot solution is easily reduced by stannous chloride:

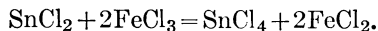

The complete decolorization of the solution shows the end-point of reduction. The excess of stannous chloride is afterwards oxidized by means of mercuric chloride:

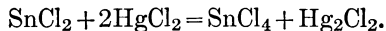

After this treatment, which consumes but a few minutes, some manganese sulphate solution is added and the solution immediately titrated with potassium permanganate, which is added slowly.

Requirements.

(a) Stannous chloride solution. 50 gms. of stannous chloride are dissolved in 100 c.c. of concentrated hydrochloric acid and diluted with water to a volume of one liter.

(b) Hydrochloric acid, sp. gr. 1.12.

* Loc. cit.

(c) Mercuric chloride solution. A saturated solution of the pure commercial salt in water is used.

(d) Manganese sulphate solution. See p. 607.

Procedure.—The ferric salt is dissolved in 20 to 25 c.c. of the hydrochloric acid (b) heated to boiling, the flame removed, and the stannous chloride solution (a) is added *drop by drop* until the iron solution just becomes colorless. The solution is cooled to at least the room temperature and 10 c.c. of mercuric chloride (c) are quickly added, whereby a slight silky precipitate of Hg_2Cl_2^* is formed. After ten minutes the solution is diluted to about 500 c.c., 20 to 25 c.c. of the manganese sulphate solution (d) are added, and the mixture is titrated (very slowly) with potassium permanganate until a pink color permanent for one minute is obtained.

Example: Determination of Iron in Hematite, Fe_2O_3 .—About 0.25 to 0.3 gm. of the finely-powdered mineral is weighed out into a beaker, 3 c.c. of the stannous chloride solution (a) † are added and 25 c.c. of the acid (b). The beaker is covered with a watch-glass and its contents heated nearly to boiling until all of the iron oxide has dissolved and a white sandy residue is obtained. This operation seldom requires more than ten minutes. The slightly yellow colored solution thus obtained is carefully treated with stannous chloride drop by drop until it becomes colorless and the reduced solution is analyzed as above.

* If the precipitate produced by mercuric chloride is at all grayish in color, the portion must be thrown away; too large an excess of stannous chloride was used. Moreover, the end point with permanganate is difficult to see if the solution contains much precipitate.

† The stannous chloride greatly facilitates the solution of the hematite. If too much is used, strong permanganate should be added drop by drop until the yellow color of ferric chloride appears, and the solution then carefully decolorized again.

Determination of Metallic Iron in the Presence of Iron Oxide.

This method is useful for testing *ferrum reductum* which is obtained by the reduction of Fe_2O_3 in a stream of hydrogen. Usually the reduction is not complete and the preparation contains, besides the metallic iron, some oxide, usually assumed to be Fe_3O_4 . The value of the preparation depends upon the free iron content.

(a) Method of Wilner—Merck.†*

Principle.—The method is based upon the fact that a neutral solution of mercuric chloride dissolves iron according to the equation

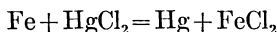

while the Fe_3O_4 is not attacked. The solution of ferrous chloride is titrated with permanganate solution.

Procedure.—About 0.5 g. of *ferrum reductum*, in the form of a fine powder,‡ is placed in a 100 c.c. graduated flask, from which the air is replaced by CO_2 , 3 gms. of solid mercuric chloride are added and 50 c.c. of water. The contents of the flask are then heated to boiling, by means of a small flame, and the liquid boiled for a minute. The flask is then filled up to the mark with boiled water. After cooling to 15° the solution is again carefully brought to the mark, well shaken, and then allowed to stand in the stoppered flask until the precipitate has settled. The liquid is then poured through a dry filter and the filtrate caught in a flask filled with carbon dioxide. Of this filtrate, 20 c.c. are taken, acidified with 20 c.c. of sulphuric acid (1:4), treated with 10 c.c. of manganese sulphate solution,§ diluted to 200 c.c., and treated with tenth-normal permanganate solution.

* Farm. Tidskrift, 1880, 225.

† Z. anal. Chem., 41, 710 (1902).

‡ A coarse powder is not decomposed quantitatively.

§ See page 607.

*The Ferric Chloride Method.**

Principle.—A neutral solution of ferric chloride dissolves metallic iron with the formation of ferrous chloride:

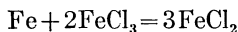

and the ferrous chloride formed is titrated with permanganate solution. One-third of the iron thus found corresponds to the weight of metallic iron present in the sample.

Procedure.—About 0.5 g. of *ferrum reductum* are placed in a 100 c.c. graduated flask, which has been filled with CO_2 , and 50 c.c. of ferric chloride are added (1 gm. anhydrous ferric chloride in 20 c.c. water).† The flask is stoppered and its contents frequently shaken during the next fifteen or twenty minutes. The solution is then brought to the mark with cold, boiled water, mixed, the flask stoppered, and allowed to stand over night. Of the clear supernatant liquid, 20 c.c. are removed by a pipette and titrated, as in the previous method, with tenth-normal permanganate solution.‡

2. Determination of Manganese. Method of Volhard.§

$$1000 \text{ c.c. N. KMnO}_4 \parallel = \frac{3\text{Mn}}{10} = \frac{3 \times 54.93}{10} = 16.48 \text{ gms. Mn.}$$

If an almost boiling, slightly acid solution of manganese sulphate is slowly treated with a solution of potassium permanga-

* A. Christensen, Z. anal. Chem., **44**, 535 (1905).

† The ferric chloride must give a clear solution in cold water. As it often contains a little ferrous chloride, a blank test must be made and a correction, corresponding to the amount of iron found, applied to the analysis proper.

‡ For other methods of analyzing *ferrum reductum*, see E. Schmidt, Chem. Ztg., **21**, 700 (1897). A. Marquardt, *Ibid.*, **45**, 743 (1901). L. Wolfrum, Inaug. Dissert., Erlanger, 1896. F. Förster and V. Herold, z. Elektrochem. **1910**, 461.

§ Ann. d. Chem. und Pharm., **198**, 318.

|| Strictly speaking, the normality of the permanganate is different when used to oxidize manganese in slightly acid or neutral solution. In this case

nate, each drop will cause the formation of manganous acid (H_2MnO_3), which is formed under certain conditions, as described below, according to the following scheme:

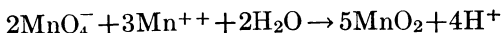

According to this equation, therefore, $2KMnO_4$ will oxidize 3 gm.-atoms of manganese, and as 1000 c.c. of N. $KMnO_4$ contain $\frac{1}{5}$ gm.-mol. $KMnO_4$, evidently this amount of permanganate corresponds to $\frac{3Mn}{10} = 16.48$ gms. Mn.

A. Guyard, who first determined manganese by this method, assumed that the oxidation took place according to the following equation:

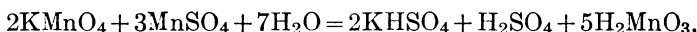

In reality, however, the reaction does not take place in this way, but instead of pure manganous acid being precipitated, different acid manganites of varying composition are formed; e.g.,

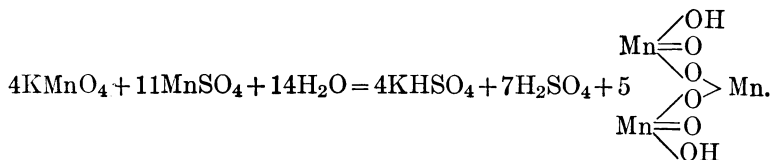

Volhard has shown that if calcium, barium, or, better still, zinc salts, are present, manganites of these metals are precipitated

the manganese of the permanganate is reduced to the quadrivalent form instead of to bivalent manganese, so that a normal solution would now contain $\frac{KMnO_4}{3}$ gms. instead of $\frac{KMnO_4}{5}$ gms. Inasmuch as it is customary to standardize permanganate as outlined on pages 597-603, we shall understand by *normal* $KMnO_4$, a solution containing one-fifth of the molecular weight. —[Translator.]

The precipitate, although varying in composition, contains all of the manganese in the quadrivalent form; e.g.,

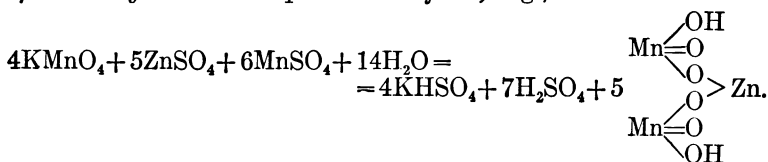

In case iron is present, the reaction does not take place quantitatively in the direction from left to right, so that a different procedure is then necessary.

(A) PROCEDURE WHEN IRON IS ABSENT.

Requirements.—1. A $\frac{N}{10}$ potassium permanganate solution.

2. A manganese sulphate solution, obtained by dissolving 4.530 gms. of anhydrous manganous sulphate in one liter of solution:

1 c.c. of this solution = 1 c.c. of $\frac{N}{10}$ KMnO_4 .*

3. A zinc sulphate solution obtained by dissolving 200 gms. zinc sulphate in one liter of water.

4. Zinc oxide suspended in water, obtained by precipitating pure zinc sulphate by means of caustic potash solution in such a way that the solution does not react alkaline. The residue is washed several times with hot water, then transferred to a tightly-stoppered bottle, and kept suspended in water.

Standardization of the Permanganate Solution.

20 c.c. of the manganese sulphate solution are placed in an Erlenmeyer flask, 40 c.c. of zinc sulphate solution and 2 or 3 drops of nitric acid † are added, after which the mixture is diluted to

* Strictly speaking, this solution is $\frac{1}{5}$ normal. By definition, a $\frac{N}{10}$ solution of manganese sulphate contains $\frac{\text{MnSO}_4}{20} = 7.550$ gms. MnSO_4 in one liter. Such a solution, however, would not be equivalent to a KMnO_4 solution which is tenth normal *in acid solution*. Cf. foot-note to page 527 (Translator).

† The addition of the nitric acid causes the precipitate to settle much more quickly.

200 c.c., heated to boiling, and treated with potassium permanganate solution, added with constant shaking, until the supernatant liquid remains a permanent pink.

Titration of Manganese.

If a neutral solution of manganese sulphate is to be analyzed, the same procedure is used as in the above standardization. If the solution contains manganous chloride, it should be freed from hydrochloric acid by evaporation with an excess of sulphuric acid. The acid solution thus obtained is neutralized with the zinc oxide until a little of the latter remains suspended in the liquid. From this point the procedure is the same as before.

(B) PROCEDURE WHEN IRON IS PRESENT.

If a hydrochloric acid solution is to be analyzed containing all of the iron in the ferric form, it is evaporated to dryness with the addition of sulphuric acid, the dry mass is moistened with nitric acid and warmed until complete solution is effected. The greater part of the acid is neutralized with sodium hydroxide solution, the solution placed in a measuring-flask, and an excess of the zinc oxide is added whereby all of the iron is precipitated as hydroxide. The liquid is diluted up to the mark with water, filtered through a dry filter, and an aliquot part of the filtrate is titrated as before with potassium permanganate solution.*

Determination of Manganese in Steel.

(a) *Volhard Method.*

The solution is prepared for titration by dissolving the steel borings † in nitric acid (sp. gr. 1.2), evaporating the solution, after the addition of 20 c.c. of 50 per cent. sulphuric acid, allowing the residue to cool, and then adding 150 c.c. of cold water. The water is boiled until the ferric sulphate is all dissolved, the solution filtered, the filtrate nearly neutralized with sodium carbonate and the zinc oxide added exactly as described above.

* The first few cubic centimeters of the filtrate should be discarded, for the dry filter absorbs some of the dissolved substance.

† Three gms. of steel are used when the manganese content is about 1 per cent, less when the content is higher. The process is not well suited for low manganese steels.

(b) The Bismuthate Method.

This method originated with Schneider,† who used bismuth tetroxide as the oxidizing agent, but as the oxide is difficult to prepare free from chlorides and traces of chloride interfere with the end point of the titration, it was abandoned by Reddrop and Ramage,‡ who proposed the use of sodium bismuthate, NaBiO_3 . The product sold under this name is of more or less indefinite composition. It may be prepared by heating 20 parts of caustic soda nearly to redness in an iron or nickel crucible, adding in small quantities from time to time ten parts of dry basic bismuth nitrate, followed by two parts of sodium peroxide, pouring the yellow fused mass on an iron plate to cool. When cold, the fusion is extracted with water, collected on an asbestos filter, washed five times by decantation with water, and dried in the hot closet at 110° . After grinding and sifting the product is ready for use.

The process is based on the fact that a manganous salt in the presence of an excess of nitric acid is oxidized to permanganic acid by sodium bismuthate. The permanganic acid formed is very stable in nitric acid of 1.135 sp. gr. when the solution is cold, but in hot solutions the excess of bismuthate is rapidly decomposed and then the nitric acid reacts with the permanganic acid; as soon as a small amount of manganous salt is formed the remainder of the permanganic acid is decomposed, manganous nitrate dissolves and manganese dioxide precipitates.

In the cold, however, the excess of the bismuth salt may be filtered off and to the clear filtrate an excess of ferrous sulphate added; the excess of the latter is determined by titrating with permanganate. The end-reactions are very sharp and the method is extremely accurate.

1000 c.c. N. $\text{KMnO}_4 = 10.99$ gms. Mn.

* A. A. Blair, *J. Am. Chem. Soc.* **26**, 793.

† *Ding. poly. J.* **269**, 224.

‡ *Trans. Chem. Soc.* 1895, 268.

Procedure for Steels.—Dissolve 1 gm. of drillings in 50 c.c. of nitric acid (sp. gr. 1.135*) in an Erlenmeyer flask of 200 c.c. capacity, cool, and add about 0.5 gm. of bismuthate. The bismuthate may be measured in a small spoon and experience will soon enable the operator to judge of the amount with sufficient accuracy. Heat for a few minutes or until the pink color has disappeared, with or without the precipitation of manganese dioxide. If the solution now shows precipitated manganese dioxide, add crystals of ferrous sulphate free from manganese, sulphurous acid or sodium thiosulphate until it becomes clear. Heat for two minutes to remove oxides of nitrogen and cool to about 15°. Now add 2 or 3 gms. more of sodium bismuthate and agitate the contents of the flask for several minutes. Dilute with 50 c.c. of 3 per cent. nitric acid and filter through an asbestos filter, using gentle suction. Wash the asbestos with 50 to 100 c.c. of cold 3 per cent. nitric acid.† Run into this solution 50 c.c. of standardized ferrous sulphate solution‡ and titrate back to pink color with potassium permanganate.§

The value of the ferrous sulphate solution in terms of potassium permanganate must be determined in the following manner:

Measure into a 250-c.c. Erlenmeyer flask 50 c.c. of cold nitric acid (sp. gr. 1.13), add about 0.5 gm. of sodium bismuthate, agitate, dilute with 50 c.c. of 3 per cent nitric acid and filter through asbestos. To the filtrate add 50 c.c. of ferrous sulphate solution and titrate with permanganate solution to pink color.

Having determined the value of the permanganate solution in terms of ferrous sulphate, the manganese in the sample is represented by the difference between the amounts of permanganate solution actually used in the determination and in the

* Concentrated nitric acid mixed with three times as much water. This is often called 25 per cent nitric acid (by volume). It contains 22.5 per cent nitric acid by weight.

† 30 c.c. HNO_3 , sp. gr. 1.42, in one liter of water.

‡ An approximately 0.03 N solution made by dissolving 9 gms. crystallized ferrous sulphate, $\text{FeSO}_4 \cdot 7\text{H}_2\text{O}$ or 12 gms. of ferrous ammonium sulphate, $\text{FeSC}_4 \cdot (\text{NH}_4)_2\text{SO}_4 \cdot 6\text{H}_2\text{O}$ in 950 c.c. water and 50 c.c. of concentrated sulphuric acid.

§ 1 gm. KMnO_4 to the liter.

titration of a volume of ferrous sulphate equivalent to that used in the determination.

Pig Iron.—Dissolve 1 gm. in 25 c.c. of nitric acid (sp. gr. 1.135) in a small beaker and as soon as the action has ceased filter on a 7-cm. filter into a 200-c.c. Erlenmeyer flask, wash with 30 c.c. of the same acid as proceed as in the case of steels.

In the analysis of white irons it may be necessary to treat the solution several times with bismuthate to destroy the combined carbon. The solution, when cold, should be nearly colorless; if not, another treatment with bismuthate is necessary.

Iron Ores Containing Less than Two Per Cent. of Manganese.—Treat 1 gm. in a platinum dish or crucible with 4 c.c. of strong sulphuric acid, 10 c.c. of water and 10 to 20 c.c. of hydrofluoric acid. Evaporate until the sulphuric acid fumes freely. Cool and dissolve in 25 c.c. of 1.135 nitric acid. If no appreciable residue remains, transfer to a 200-c.c. Erlenmeyer flask, using 25 c.c. of 1.135 nitric acid to rinse the dish or crucible and proceed as usual. If there is an appreciable residue, filter on a small filter into a beaker, wash with water, burn the filter and residue in a crucible and fuse with a small amount of potassium bisulphate. Dissolve in water with the addition of a little nitric acid, add to the main filtrate, evaporate nearly to dryness, take up in 1.135 nitric acid and transfer to the flask as before.

Manganese Ores and Iron Ores High in Manganese.—Treat 1 gm. as in the case of iron ores, using a little sulphurous acid, if necessary. Transfer the solution to a 500-c.c. flask, dilute to the mark, mix thoroughly and measure into a flask from a carefully calibrated pipette such a volume of the solution as will give from 1 to 2 per cent. of manganese and enough strong nitric acid (sp. gr. 1.4) to yield a mixture of 1.135 acid in a volume of 50 to 60 c.c.

Ferro-manganese.—Treat 1 gm. exactly like steel. Dilute to 500 or 1000 c.c. and proceed as in manganese ores.

Ferro-silicon.—Treat 1 gm. with sulphuric and hydrofluoric acids and proceed as with iron ores.

Special Steels.—Steels containing chromium offer no special difficulties, except that it must be noted that while in hot solutions the chromium is oxidized to chromic acid, which is reduced by the addition of sulphurous acid, the oxidation proceeds so

slowly in cold solutions that if there is no delay in the filtration and titration the results are not affected. If much chromium is present, however, it is advisable to separate the chromium and manganese by precipitating the former as in the method of Volhard, p. 615, and determine the manganese in an aliquot part of the filtrate. Steels containing tungsten are sometimes troublesome on account of the necessity for getting rid of the tungstic acid. Those that decompose readily in nitric acid may be filtered and the filtrate treated like pig iron, but when it is necessary to use hydrochloric acid it is best to treat with *aqua regia*, evaporate to dryness, redissolve in hydrochloric acid, add a few drops of nitric acid, dilute, boil, and filter. Get rid of every trace of hydrochloric acid by repeated evaporations with nitric acid and proceed as with an ordinary steel.

(c) *Williams Method*.*

$$1000 \text{ c.c. } \frac{N}{10} \text{ KMnO}_4 = \frac{Mn}{20} = \frac{54.93}{20} = 2.747 \text{ gms. Mn.}$$

Principle.—If a nitric acid solution of a manganous salt is heated with potassium chlorate, all of the manganese is precipitated as the dioxide:

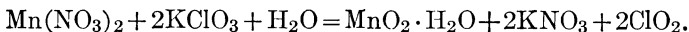

The MnO_2 is dissolved in a measured volume of acid ferrous sulphate, and the excess is titrated with tenth-normal permanganate.

Procedure.—From 2 to 3 gms. of an ordinary steel, about 1 gm. of "spiegel" or 0.3 to 0.5 gm. of ferromanganese are weighed into a 600 c.c. Erlenmeyer flask and dissolved in 60 c.c. of nitric acid, sp. gr. 1.2. To prevent loss by spattering, a small funnel is placed in the neck of the flask. After evaporating the solution to a volume of about 15 c.c., 50 c.c. of concentrated nitric acid, sp. gr. 1.42, and 3 gms. of solid potassium chlorate are added, and the solution is boiled for fifteen minutes. It is then removed from the source of heat and the treatment with 50 c.c. concentrated nitric acid and 3 gms. of potassium chlorate is repeated, after which the solution is boiled for fifteen minutes longer. The solution is cooled quickly by placing the flask in cold water, and

* *Trans. Inst. Min. Eng.*, 10, 100. See also W. Hampe, *Chem. Ztg.*, 7, 73 (1883), 9, 1478 (1885), and Ukena, *Stahl und Eisen*, 11, 373 (1891).

the precipitated manganese dioxide is filtered on asbestos,* washed with concentrated nitric acid till free from iron, and with water till free from acid. The asbestos pad and precipitate is transferred to the original flask, covered with 50 c.c. of standardized ferrous sulphate solution,† and diluted with water to a volume of 200 c.c. The contents of the flask are shaken with glass beads until all the precipitate is dissolved, and the solution is then titrated with tenth-normal permanganate.

The amount of manganese present is computed as follows:

50 c.c. of ferrous sulphate solution require T c.c. 0.1 N. KNO_3 ;

50 c.c. of ferrous sulphate after acting with the permanganate acid from a g. of steel require t c.c. of 0.1 N. KMnO_4 . Consequently a g. of the substance = $(T-t)$ c.c. 0.1 N. KMnO_4 and

$$\frac{0.002747(T-t) \times 100}{a} = \% \text{ Mn.}$$

Remark.—In the analysis of cast iron, the sample should be dissolved in hydrochloric acid and the insoluble residue should be fused with sodium carbonate to see if it contains manganese. If the melt is green, showing manganese, it should be dissolved in hydrochloric acid and added to the main solution, which is evaporated nearly to dryness and again with nitric acid in order to remove all the hydrochloric acid.

(d) *G. v. Knorre's Persulphate Method.*‡

Principle.—If a solution of manganous sulphate containing a little free sulphuric acid is treated with ammonium persulphate, the manganese is precipitated quantitatively as hydrated manganese dioxide.



and the latter can be estimated as in the above determination.

Procedure.—In the case of the harder alloys of iron and manganese, the sample is pulverized as much as possible in a steel mortar. The weights of sample taken correspond to those recommended for the previous determination. The weighed substance is treated in a beaker with sulphuric acid (1:10) at the boiling

* A satisfactory filter is obtained by placing a little glass wool in a funnel, and on this a little asbestos, such as is used for Gooch crucibles.

† 10 gm. $\text{FeSO}_4 \cdot 7\text{H}_2\text{O}$, 50 c.c. concentrated H_2SO_4 , and 950 c.c. water.

‡ *Z. angew. Chem.*, 14, 1149 (1901).

temperature, using 50 c.c. of the dilute acid for the harder alloys and 60 c.c. for the softer ones. As soon as the evolution of hydrogen ceases, the solution is filtered through a small filter which is washed with cold water until the washings give no test for iron with potassium ferricyanide. Frequently, especially in the case of ferro-manganese rich in silicon, the insoluble residue still contains a little manganese, so that for an accurate analysis Ledebur ignites the filter and precipitate in a platinum crucible, treats the residue with hydrofluoric acid and about 0.5 c.c. of concentrated sulphuric acid, and evaporates in an air bath until sulphuric anhydride vapors are evolved. After cooling the contents of the crucible are added to the main solution. Then from 150 to 250 c.c. of ammonium persulphate solution are added (60 gms. per liter) the solution diluted to about 300 c.c. and heated to boiling. After boiling for fifteen minutes, the precipitate is allowed to settle and is filtered, washed, treated with an excess of ferrous sulphate solution and titrated exactly as in the previous Williams method.

3. Determination of Uranium. Method of Belhoubek,* Zimmermann,† Hillebrand.‡

$$1000 \text{ c.c. N. KMnO}_4 = \frac{U}{2} = \frac{238.5}{2} = 119.3 \text{ gms. U.}$$

This method is especially suited for testing the purity of a precipitate of U_3O_8 obtained in the analysis of uranium minerals. It is based upon the fact that when U_3O_8 is heated in a closed tube with dilute sulphuric acid at 150° to 175° C. it is readily decomposed according to the equation

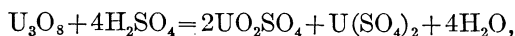

forming uranyl and uranous sulphates. The latter compound is oxidized to the former by means of potassium permanganate,

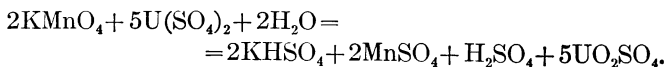

* Journ. f. prakt. Chem., 99, 231.

† Ann. der Chem. u. Pharm., 232, 285.

‡ U. S. Geol. Survey, No. 78, 90 (1889).

From this equation it follows that 2 gm.-mols. of KMnO_4 are equivalent to 5 gm.-atoms of uranium, and 1000 c.c. N. KMnO_4 solution ($=\frac{1}{2}\text{KMnO}_4$) $=\frac{1}{2}$ gm.-atom of uranium $=\frac{\text{U}}{2} = \frac{238.5}{2} = 119.25$ gms. U.

Procedure.—The weighed amount of U_3O_8 is placed in a tube closed at one end, 10 to 15 c.c. of dilute sulphuric acid (1:6) are added, and the open end of the tube is made narrower by heating in a blast-lamp and drawing it out somewhat. The air in the tube is removed by inserting a long capillary so that it reaches to the bottom of the tube containing the substance, and conducting a current of carbon dioxide through it; the larger tube is finally sealed without removing the capillary. The tube is then heated in a "bomb furnace" at 150–175° C. until everything has dissolved to a clear green liquid. After cooling, the tube is opened by making a scratch with a file and touching it with a hot glass rod. The contents are poured into a large porcelain dish, diluted with distilled water to 500–700 c.c., and titrated with $\frac{\text{N}}{10}$ KMnO_4 solution until a permanent pink color is obtained.

1 c.c. $\frac{\text{N}}{10}$ $\text{KMnO}_4 = 0.011925$ gm. U $= 0.013525$ gm. UO_2 oxidized.*

Remark.—The above method gives very exact results.

4. Determination of Oxalic Acid.

1000 c.c. N. $\text{KMnO}_4 = \frac{\text{H}_2\text{C}_2\text{O}_4 \cdot 2\text{H}_2\text{O}}{2} = \frac{126.05}{2} = 63.02$ gms. $\text{H}_2\text{C}_2\text{O}_4 \cdot 2\text{H}_2\text{O}$.

The procedure is exactly the same as was described under the standardization of permanganate by means of oxalic acid (page 598)

* It must be remembered, however, that only one-third of the total uranium in U_3O_8 has been oxidized by the KMnO_4 ($\text{U}_3\text{O}_8 = 2\text{UO}_3 + \text{UO}_2$). Consequently, with regard to the total uranium, 1 c.c. $\frac{\text{N}}{10}$ $\text{KMnO}_4 = 0.03578$ gm. U $= 0.04218$ gm. U_3O_8 .—[Translator].

5. Determination of Calcium.

$$1000 \text{ c.c. N. KMnO}_4 = \frac{\text{Ca}}{2} = \frac{40.09}{2} = 20.05 \text{ gms. Ca.}$$

The calcium is precipitated as described on p. 70 in the form of its oxalate, filtered, and washed with hot water. The still moist precipitate is transferred to a beaker by means of a stream of water from the wash-bottle, and the part remaining on the filter is removed by allowing warm dilute sulphuric acid to pass through it several times. To the turbid solution in the beaker, 20 c.c. of sulphuric acid (1:1) are added, and after dilution with hot water to a volume of from 300 to 400 c.c. the oxalic acid is titrated with $\frac{\text{N}}{10}$ KMnO_4 solution.

$$1 \text{ c.c. } \frac{\text{N}}{10} \text{ KMnO}_4 = 0.002005 \text{ gm. Ca.}$$

6. Determination of PbO_2 in Minium [$\text{Red Lead, Pb}_3\text{O}_4$]. Method of Lux.*

$$1000 \text{ c.c. N. KMnO}_4 = \frac{\text{PbO}_2}{2} = \frac{239.1}{2} = 119.55 \text{ gms. PbO}_2.$$

Principle.—If lead peroxide (PbO_2) is treated with oxalic acid in acid solution, the latter is oxidized according to the following equation:

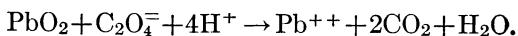

If the decomposition takes place with a measured amount of titrated oxalic acid solution and the excess of the latter is titrated by means of potassium permanganate solution, the difference shows the amount of oxalic acid necessary to effect the reduction of the lead peroxide.

Procedure.—About 0.25 gm. of minium (red lead) is weighed into a porcelain dish and heated with 20 to 30 c.c. of double normal nitric acid.† The original oxide is thereby changed into soluble lead nitrate and brown, insoluble H_2PbO_3 :

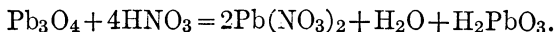

After solution is effected, 50 c.c. $\frac{\text{N}}{5}$ oxalic acid are added, the

* Z. anal. Chem., 19, p. 153.

† Nitric acid sp. gr. 1.2 diluted with two volumes of water.

solution is heated to boiling, and titrated hot with $\frac{N}{5}$ KMnO_4 . If t c.c. $\frac{N}{5}$ KMnO_4 solution were used, then $50-t$ c.c. $\frac{N}{5}$ $\text{H}_2\text{C}_2\text{O}_4$ were necessary for the reduction of the amount of PbO_2 contained in the minium (a gm.) taken for analysis.

Since 1000 c.c. N . $\text{H}_2\text{C}_2\text{O}_4 = 119.55$ gms. PbO_2 , then 1000 c.c. $\frac{N}{5}$ $\text{H}_2\text{C}_2\text{O}_4 = \frac{119.55}{5} = 23.91$ gms. PbO_2 and 1 c.c. = 0.02391 gm. PbO_2 .

Consequently

$(50-t)$ c.c. $\frac{N}{5}$ oxalic acid correspond to $(50-t) \times 0.02391$ gm. PbO_2 .

The per cent. of the latter is

$$a : (50-t) \times 0.02391 = 100 : x$$

$$x = \frac{(50-t) \times 2.391}{a} \text{ per cent. } \text{PbO}_2.*$$

7. Determination of MnO_2 in Pyrolusite.

$$1000 \text{ c.c. } N. \text{ KMnO}_4 = \frac{\text{MnO}_2}{2} = \frac{86.93}{2} = 43.47 \text{ gms. MnO}_2.$$

(a) *Method of Levöl and Poggiale, Modified by G. Lunge.*†

After drying at 100° to constant weight, 1.0866 gms. of the finely powdered pyrolusite are placed in a 250 c.c. flask which is provided with a Contat valve (see page 602). The air is expelled by conducting CO_2 into the flask, and then 75 c.c. of the ferrous sulphate solution, prepared as described below, are added, the flask closed, and its contents heated over a small flame until there is no longer any dark-colored residue. The flask is cooled quickly, the contents diluted with 200 c.c. water, and the excess of ferrous sulphate titrated with 0.5N KMnO_4 solution. Immediately before the analysis, the titer of the ferro-sulphate solution is determined by taking 25 c.c. of it, diluting to 200 c.c. and titrating with permanganate.

* To express the results in per cent. Pb_3O_4 , the number 2.391 should be replaced by 6.853.—[Translator.]

† Chem.-techn. Untersuchungsmethoden. Edition 6, Vol. I., p. 569.

By the treatment of the pyrolusite with ferrous sulphate, the following reaction takes place:

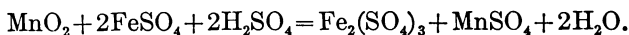

The computation of the percentage of MnO_2 is as follows:

$$\begin{array}{l} 75 \text{ c.c. FeSO}_4 \text{ solution. require T c.c. 0.5N KMnO}_4 \\ 75 \text{ c.c. FeSO}_4 + 1.0866 \text{ gms. pyrolusite. " t c.c. 0.5N KMnO}_4 \\ \hline \therefore 1.0866 \text{ gms. pyrolusite require T - t c.c. 0.5N KMnO}_4 \end{array}$$

corresponding to $(T - t) \times 0.02173$ gm. MnO_2 and in percentage

$$\frac{(T - t) \times 0.02173 \times 100}{1.0866} = 2(T - t)\% \text{ MnO}_2.$$

The ferrous sulphate solution is prepared as follows: 200 c.c. of concentrated sulphuric acid are slowly poured, with stirring, into 500 c.c. of water and while the mixture is still hot 100 gms. of powdered $\text{FeSO}_4 \cdot 7\text{H}_2\text{O}$ crystals are added; on stirring, solution should take place within a few minutes. The solution is finally diluted to one liter, and when cold is ready for use.

(b) *The Oxalic Acid Method of Fresenius-Will, Modified by Mohr.**

About 0.4 gm. of finely powdered pyrolusite, which has been dried at 100° , is heated on the water-bath with 50 c.c. $\frac{\text{N}}{5}$ oxalic acid and 20 c.c. sulphuric acid (1:4) until no more black particles remain undissolved. The solution is diluted with 200 c.c. of hot water and titrated with $\frac{\text{N}}{5}$ KMnO_4 solution. The reaction which takes place between the manganese dioxide and the oxalic acid is expressed by the following equation:

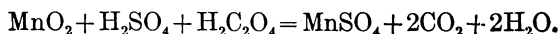

$$1 \text{ c.c. } \frac{\text{N}}{5} \text{ KMnO}_4 = 1 \text{ c.c. } \frac{\text{N}}{5} \text{ H}_2\text{C}_2\text{O}_4 = 0.0087 \text{ gm. MnO}_2.$$

* Fresenius-Will carried out the analysis in an alkalimeter and determined the CO_2 evolved by loss in weight.

8. Determination of Formic Acid (Lieben).*

$$1000 \text{ c.c. N. KMnO}_4 = \frac{3 \times \text{HCOOH}}{10} = \frac{3 \times 46.02}{10} = 13.80 \text{ gms. HCOOH.} \dagger$$

In cold *acid* solutions permanganate reacts only slowly with formic acid, while in a hot solution the latter is lost by volatilization, so that the titration in open vessels is impossible; in *alkaline* solutions, on the other hand, the oxidation takes place readily and quantitatively in the cold:



Procedure.—The formic acid is neutralized by an excess of sodium carbonate, and permanganate is run into the hot † sodium formate solution until the clear liquid above the precipitate is colored reddish.

9. Analysis of Nitrous Acid (Lunge).

$$1000 \text{ c.c. N. KMnO}_4 = \frac{\text{HNO}_2}{2} = \frac{47.018}{2} = 23.51 \text{ gms. HNO}_2.$$

On account of the volatility of nitrous acid, the aqueous solution of the nitrite, or the solution of nitrous acid in concentrated sulphuric acid (nitrose), is measured from a burette into a known amount of permanganate solution, which has been made acid with sulphuric acid, diluted to a volume of about 400 c.c. and warmed to 40° C. The nitrous acid is thereby oxidized to nitric acid:



and the decolorization of the solution shows the end-point. Toward the end the nitrous acid must be added slowly, for the change from red to colorless requires some time.

10. Analysis of Hydrogen Peroxide.

$$1000 \text{ c.c. N. KMnO}_4 = \frac{\text{H}_2\text{O}_2}{2} = \frac{34.02}{2} = 17.01 \text{ gms. H}_2\text{O}_2.$$

Ten cubic centimeters of commercial 3 per cent. hydrogen peroxide are placed in a 100-c.c. measuring-flask, diluted up

* Monatshefte, XIV, p 746, and XVI, p. 219.

† In reality, the normal solution of formic acid would contain $\frac{1}{2}$ (not $\frac{3}{10}$) the molecular weight. See foot-note to page 612.

‡ The titration is made in hot solution because the manganous acid formed does not settle well from a cold solution.

to the mark with water, and, after thoroughly mixing, 10 c. c. (=1 c. c. of the original solution) are placed in a beaker, and diluted with water to a volume of 300 to 400 c. c. After adding 20 to 30 c. c. of sulphuric acid (1:4), the solution is titrated with $\frac{N}{10}$ KMnO_4 until a permanent pink color is obtained. The following reaction takes place:



Frequently it happens that the first drop of the permanganate causes a permanent coloration of the solution. This shows that either not enough sulphuric acid is present, or else there is no more hydrogen peroxide left in the solution. In this case a little more sulphuric acid is added, when if the coloration still remains the preparation is surely spoiled, as can be shown by the titanous or chromous acid tests (cf. Vol. I).

The amount of hydrogen peroxide is expressed either as per cent. by weight or as per cent. by volume.

Example.—10 c. c. of the above-mentioned dilute solution of hydrogen peroxide (=1 c. c. of the original solution) required 17.86 c. c. $\frac{N}{10}$ KMnO_4 solution, corresponding to

$$17.86 \times 0.001701 = 0.03038 \text{ gm. H}_2\text{O}_2.$$

As the specific gravity of the original hydrogen peroxide solution can be assumed to be 1, it therefore contains 3.04 per cent. H_2O_2 .

When expressed in "per cent. by volume" the result shows how many cubic centimeters of oxygen can be obtained from 100 c. c. of the solution.

In this case 100 c. c. of the hydrogen peroxide solution contain 3.04 gms. of H_2O_2 and, on being decomposed, 1 gm.-mol. H_2O_2 sets free 1 gm.-at. O:

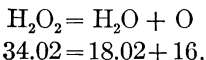

or 11195 c. c. of oxygen at 0° C. and 760 mm. pressure; consequently 3.04 gms. H_2O_2 will evolve

$$34.02 : 11195 = 3.04 : x$$

$x = \frac{3.04 \times 11200}{34.02} = 1000$ c. c. oxygen measured under standard conditions of temperature and pressure.

100 c.c. of the commercial hydrogen peroxide, therefore, will evolve 1000 c.c. of oxygen, i.e., ten times its own volume. This is somewhat anomalously designated as hydrogen peroxide of 10 per cent. by volume.

100 c.c. 3 per cent. hydrogen peroxide = 10 per cent. by volume.

100 c.c. 6 " " " " = 20 " " " "

100 c.c. 9 " " " " = 30 " " " "

11. Analysis of Barium Peroxide.

$$1000 \text{ c.c. N. KMnO}_4 = \frac{\text{BaO}_2}{2} = \frac{169.4}{2} = 84.70 \text{ gms. BaO}_2.$$

About 0.2 gm. of the substance is weighed into a 400 c.c. beaker, covered with 300 c.c. of cold water, and treated, under constant stirring, with 20–30 c.c. of hydrochloric acid (1:5). When all the BaO₂ has dissolved, the solution is titrated with 0.1 N. KMnO₄. The addition of H₂SO₄ is not advisable, as the precipitated BaSO₄ is likely to enclose some BaO₂ which will then escape the titration.

Another method for the analysis of BaO₂ has been proposed by Kassner.*

12. Analysis of Potassium Percarbonate.

$$1000 \text{ c.c. N. KMnO}_4 = \frac{\text{K}_2\text{C}_2\text{O}_6}{2} = \frac{198.2}{2} = 99.10 \text{ gms. K}_2\text{C}_2\text{O}_6.$$

0.25 gm. potassium percarbonate is weighed out into 300 c.c. of cold, dilute sulphuric acid (1:30), in which it dissolves with

* Arch. Pharm., 228, 432.

violent evolution of carbon dioxide and formation of an equivalent amount of hydrogen peroxide:



and the latter is titrated with potassium permanganate.

13. Analysis of Persulphates (Persulphuric Acid, $\text{H}_2\text{S}_2\text{O}_8$).

$$1000 \text{ c.c. N. KMnO}_4 = \frac{\text{R}_2\text{S}_2\text{O}_8}{2} \left\{ \begin{array}{l} 97.08 \text{ gms. } \text{H}_2\text{S}_2\text{O}_8 \\ 111.4 \text{ " } (\text{NH}_4)_2\text{S}_2\text{O}_8 \\ 135.2 \text{ " } \text{K}_2\text{S}_2\text{O}_8 \end{array} \right.$$

A solution of persulphuric acid does not reduce permanganate, nor does it react with titanous acid; on the other hand it oxidizes ferrous salts immediately in the cold to ferric salts, and by means of this behavior it can be easily determined. The ammonium and potassium salts are now commercial products, and are analyzed as follows: About 0.3 gm. of the salt is weighed out into a flask fitted with a Bunsen valve, the air is replaced by carbon dioxide, 30 c.c. of a freshly titrated solution of ferrous sulphate are added and then 200 c.c. of hot water; the flask is closed and its contents rotated. The salt dissolves without difficulty, and the ferrous sulphate is oxidized:

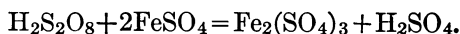

After all of the salt has dissolved, the contents of the flask are cooled by placing the flask in cold water, and the excess of ferrous salt is titrated with $\frac{N}{10}$ KMnO_4 .*

* The ferrous sulphate must be added to the persulphate, and then the hot water. If the hot water is added first, the persulphate is decomposed somewhat and the results obtained will be low.

In this way it is found that:

30 c.c. ferrous sulphate solution require T c.c. $\frac{N}{10}$ KMnO_4 solution.

30 c.c. ferrous sulphate + a gm. persulphate require t c.c. $\frac{N}{10}$ KMnO_4 solution.

Consequently a gm. of persulphate correspond to $(T-t)$ c.c. $\frac{N}{10}$ KMnO_4 .

In the case of the potassium salt, since 1000 c.c. N. $\text{KMnO}_4 = 135.2$ gms. $\text{K}_2\text{S}_2\text{O}_8$, and 1 c.c. $\frac{N}{10}$ $\text{KMnO}_4 = 0.01352$ gm. $\text{K}_2\text{S}_2\text{O}_8$, we have: $(T-t) \times 0.01352$ gm. $\text{K}_2\text{S}_2\text{O}_8$ in a gm. of the commercial salt, or in per cent.:

$$a : (T-t)0.01352 = 100 : x$$

$$x = \frac{1.352(T-t)}{a} = \text{per cent. } \text{K}_2\text{S}_2\text{O}_8.$$

With the ammonium salt the factor becomes 0.01141 instead of 0.01352.

The ferrous sulphate necessary for this determination is prepared by roughly weighing out 30 gms. of crystallized ferrous sulphate ($\text{FeSO}_4 + 7\text{H}_2\text{O}$), dissolving it in 900 c.c. of water, and diluting to 1000 c.c. with pure concentrated sulphuric acid.

Persulphates may also be analyzed very satisfactorily by means of oxalic acid.* When a sulphuric acid solution of a persulphate is treated with oxalic acid alone, there is no perceptible reaction. On adding a small amount of silver sulphate as catalyzer, however, a lively evolution of carbon dioxide takes place, and at the water-bath temperature the reaction is soon completed.

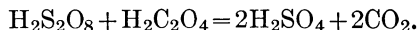

* R. Kempf, Ber., 38, 3965 (1905).

The excess of the oxalic acid can be titrated with permanganate.

Procedure.—About 0.5 gm. of the persulphate is placed in a 400-c.c. Erlenmeyer flask, 50 c.c. of tenth-normal oxalic acid solution, and a solution of 0.2 gm. silver sulphate in 20 c.c. of 10 per cent. sulphuric acid are added, and the mixture is heated on the water bath until the evolution of carbon dioxide ceases; this requires not more than 15 or 20 minutes. The solution is then diluted to about 100 c.c. with water at about 40° and titrated with tenth-normal permanganate.

14. Determination of Hydroxylamine (Raschig).*

$$1000 \text{ c.c. N. KMnO}_4 = \frac{\text{NH}_2\text{OH}}{2} = \frac{33.03}{2} = 16.52 \text{ gms. NH}_2\text{OH.}$$

Principle.—Hydroxylamine is oxidized in hot acid solution by means of ferric salts to form nitrous oxide and an equivalent amount of ferrous salt:

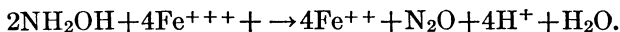

The amount of ferrous salt is determined by titration with $\frac{\text{N}}{10}$ potassium permanganate.

Procedure.—About 0.1 gm. of the hydroxylamine salt is placed in a 500-c.c. flask and dissolved in a little water, 30 c.c. of a cold saturated solution of ferric-ammonium alum are added, and 10 c.c. of dilute sulphuric acid (1 : 4). The contents of the flask are heated to boiling and kept at this temperature for five minutes, after which the solution is diluted

* Ann. d. Chem. und Pharm., 241, 318.

with distilled water to a volume of about 300 c.c. and immediately titrated with permanganate solution.

Remark.—If only slightly more than the theoretical amount of the ferric salt is added, the oxidation of the hydroxylamine does not take place entirely in accordance with the above equation, but part of the substance is oxidized to nitric oxide:

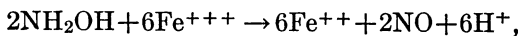

so that it is then impossible to obtain exact results.

15. Determination of Hydroferrocyanic Acid (de Haën).*

1000 c.c. N. $\text{KMnO}_4 = 1$ mol. $\text{K}_4\text{Fe}(\text{CN})_6 = 368.3$ gms. $\text{K}_4\text{Fe}(\text{CN})_6$.

Principle.—By oxidation in acid solution, hydroferricyanic acid is formed from hydroferrocyanic acid:

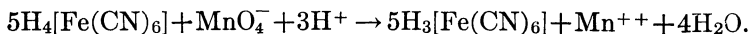

This procedure is chiefly used for the analysis of potassium ferrocyanide (yellow prussiate of potash), so that the concentration of the permanganate solution is expressed in terms of this salt.

Procedure.—0.9 gm. of the salt to be analyzed is dissolved in 100 c.c. of water, 10 c.c. of dilute sulphuric acid are added, and this solution is titrated in a porcelain dish with permanganate until a permanent pink color is obtained. It is not easy to determine the end-point. On acidifying, the solution of the ferrocyanide becomes milky with a bluish tinge, and on the addition of permanganate at first a yellow shade is obtained, afterwards becoming green, and finally on the addition of more permanganate the color changes to pink. On account of the difficulty in determining this point, de Haën recommends that the permanganate be standardized against pure potassium ferrocyanide solution ($\text{K}_4\text{Fe}(\text{CN})_6 + 3\text{H}_2\text{O}$).

* Ann. d. Chem. und Pharm., 90, p. 160.

16. Determination of Hydroferricyanic Acid.

1000 c.c. N. $\text{KMnO}_4 = 1 \text{ mol. } \text{K}_3\text{Fe}(\text{CN})_6 = 329.2 \text{ gms. } \text{K}_3\text{Fe}(\text{CN})_6$.

Principle.—The potassium ferricyanide is reduced in alkaline solution to potassium ferrocyanide, and the latter is titrated with permanganate.

Procedure.—In a 300-c.c. flask, 6.0 gms. of the ferricyanide are dissolved in water, the solution made alkaline with potassium hydroxide, heated to boiling, and an excess of a concentrated ferrous sulphate solution is added. At first yellowish-brown ferric hydroxide is precipitated, later black ferrous-ferric hydroxide is formed, and this shows the completion of the reaction. After cooling, the contents of the flask are diluted with water up to the mark, filtered through a dry filter (after thoroughly mixing), and 50 c.c. of the filtrate* (= 1 gm. of the substance) are taken for the titration with $\frac{N}{10}$ KMnO_4 solution.

17. Determination of Chloric Acid.

1000 c.c. N. $\text{KMnO}_4 = \frac{\text{RClO}_3}{6} = \begin{cases} 20.44 \text{ gms. } \text{KClO}_3 \\ 17.74 \text{ " } \text{NaClO}_3 \end{cases}$

About 5 gms. of potassium chlorate, or 4 gms. of the sodium salt, are dissolved in water, and the solution diluted to 1 liter. After thoroughly mixing, 10 c.c. are placed in a flask fitted with a Bunsen valve and the air expelled from the flask by a current of carbon dioxide. After this 50 c.c. of a freshly-standardized solution of ferrous sulphate (prepared as described on p. 630) are added, and the solution boiled ten minutes. The following reaction takes place:

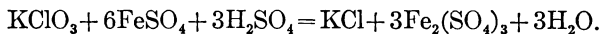

After cooling the solution is diluted with cold distilled water, 10 c.c. of manganous sulphate solution are added (cf. p. 607), and the excess of the ferrous sulphate is titrated with potassium permanganate. We find that:

* The first ten or fifteen cubic centimeters of the filtrate should be discarded.

50 c.c. ferrous sulphate required T c.c. $\frac{N}{10}$ KMnO_4 sol.

50 c.c. " " + 10 c.c. chlorate sol. " t c.c. $\frac{N}{10}$ " "

10 c.c. chlorate solution = $\frac{a}{100}$ gm. substance = $(T-t)$ c.c. $\frac{N}{10}$ KMnO_4 "

For the analysis of potassium chlorate a gm. of the substance contain $(T-t) \times 0.2044$ gm. KClO_3 , and the per cent. present is

$$\frac{20.44 \times (T-t)}{a} = \text{per cent.}$$

The calculation for sodium chlorate is analogous.

18. Determination of Nitric Acid (Pelouze-Fresenius).

$$1000 \text{ c.c. N. } \text{KMnO}_4 = \frac{\text{RNO}_3}{3} = \begin{cases} 21.01 \text{ gms. HNO}_3 \\ 28.34 \text{ " NaNO}_3 \\ 33.70 \text{ " KNO}_3 \end{cases}$$

This method depends upon the fact that on heating a nitrate in the presence of considerable hydrochloric acid and ferrous chloride the latter is oxidized to ferric chloride and the nitric acid is reduced to nitric oxide:



As a measure for the amount of nitrate reduced we have:

1. The excess of ferrous salt.
2. The ferric salt produced.
3. The nitric oxide formed.

The method of Schlösing-Grandeau described on p. 456 is based upon the measurement of the nitric oxide formed. C. D. Braun * estimates the amount of ferric salt formed, while Pelouze and Fresenius determine the amount of ferrous salt not used up in the reduction of the nitric acid.

Procedure.—A weighed amount of iron wire (about 1.5 gms.) is placed in a long-necked flask, and the air expelled by passing a current of pure carbon dioxide through it for two or three minutes. After this 30 to 40 c.c. of pure, concentrated hydrochloric acid are added and the flask is placed in an inclined position and closed by means of a rubber stopper through which tubes pass so that a current of carbon dioxide can be conducted

* Journ. f. prakt. Chem., 81 (1860), p. 421.

through the flask. The solution is heated on the water-bath in this atmosphere of carbon dioxide until the iron has completely dissolved, when the solution is allowed to cool in a current of the gas. Meanwhile about 0.25 to 0.3 gm. of the nitrate is weighed out in a small glass tube closed at one end; this is thrown into the acid solution of the ferrous sulphate and the flask quickly closed again. The flask is then once more placed in its inclined position upon the water-bath and heated for fifteen minutes, while the current of carbon dioxide is continually passed through it. The tube through which the gas leaves the flask, during the whole operation, dips into a beaker filled with water so that there is no chance of any air getting back into the flask. After this the solution is heated to boiling and kept there until its dark color disappears and the yellow color of the ferric chloride becomes apparent. In order to make sure that the nitric oxide is entirely removed, the contents of the flask are boiled five minutes longer and then allowed to cool in the atmosphere of carbon dioxide. When cold the solution is poured into a beaker, the flask washed out with a little boiled water, the solution is diluted to a volume of about 400 to 500 c.c., 10 c.c. of manganese sulphate solution are added, and the unoxidized iron is titrated with $\frac{N}{2}$ KMnO_4 solution.

The amount of pure iron present in the wire used is determined under the same conditions as prevailed during the previous operation, using a smaller portion of wire but the same amount of acid, manganese sulphate, etc.

The calculation is as follows:

If a gm. of potassium nitrate and p gm. of the wire were taken for the analysis, t c.c. of $\frac{N}{2}$ KMnO_4 were required to oxidize the excess of iron, and further p gm. of the wire require T c.c. of $\frac{N}{2}$ KMnO_4 solution, we have, then:

p gm. iron.....		require		T c.c. $\frac{N}{2}$ KMnO_4 solution
p gm. iron + a gm. saltpeter.....	“		“	t c.c. $\frac{N}{2}$ KMnO_4 “
<div style="display: flex; justify-content: space-between; align-items: center;"> and a gm. saltpeter = ($T-t$) c.c. $\frac{N}{2}$ KMnO_4, </div>				

so that a gm. of saltpeter contain $(T-t) \times 0.01685$ gm. KNO_3 , and in per cent.

$$\frac{(T-t) \times 1.685}{a} = \text{per cent. } \text{KNO}_3.*$$

Remark.—This method gives results just as accurate as those obtained by the method of Devarda, but the latter determination is much easier to carry out.

The determination becomes simpler if the contents of the iron wire is assumed to be 99.7 per cent. Fe and the second titration thus done away with. It does not take long to make the analysis of the wire, however, and it is advisable to do it. Instead of titrating the excess of the ferrous salt with potassium permanganate solution, a solution of potassium dichromate may be used. For the determination of the ferric salt formed, cf. p. 681.

19. Determination of Vanadium.

$$1000 \text{ c.c. } \frac{\text{N}}{10} \text{KMnO}_4 = \frac{\text{V}_2\text{O}_5}{20} = \frac{182.4}{20} = 9.12 \text{ gms. } \text{V}_2\text{O}_5.$$

Sulphur dioxide is conducted into the boiling solution of an alkali vanadate containing sulphuric acid until the solution appears a pure blue; by this means the vanadic acid is reduced to vanadyl salt:

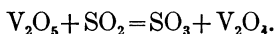

The boiling is continued and a current of carbon dioxide is passed through the solution until the escaping gas will no longer decolorize a solution of potassium permanganate, showing that the excess of the sulphur dioxide has been expelled. The hot solution is then titrated with potassium permanganate until a permanent pink color is obtained. The end-point is easily recognized only when the solution is hot. This accurate determination is used for the analysis of vanadium in iron and steel, or in ores. (Cf. p. 310.)

* Of course the calculation can be made from the amount of iron oxidized. In that case:

$$\text{Fe} : \frac{1}{3} \text{KNO}_3 = (p-t \times 0.02793) : x$$

$$x = \frac{(p-t \times 0.02793) \cdot \text{KNO}_3}{3\text{Fe}} \text{ gms. } \text{KNO}_3 \text{ in } a \text{ gm. of substance,}$$

and in per cent.

$$\frac{100(p-t \times 0.02793) \text{KNO}_3}{3\text{Fe} \cdot a} = \text{per cent } \text{KNO}_3.$$

20. Blair Method for Determining Phosphorus in Iron and Steel.*

$$1000 \text{ c.c. } \frac{N}{10} \text{KMnO}_4 = \frac{P}{350} = 0.0885 \text{ gm. P.}$$

Principle.—The substance is dissolved in nitric acid, all carbonaceous matter is destroyed by the action of strong permanganate solution, any precipitated manganese dioxide is

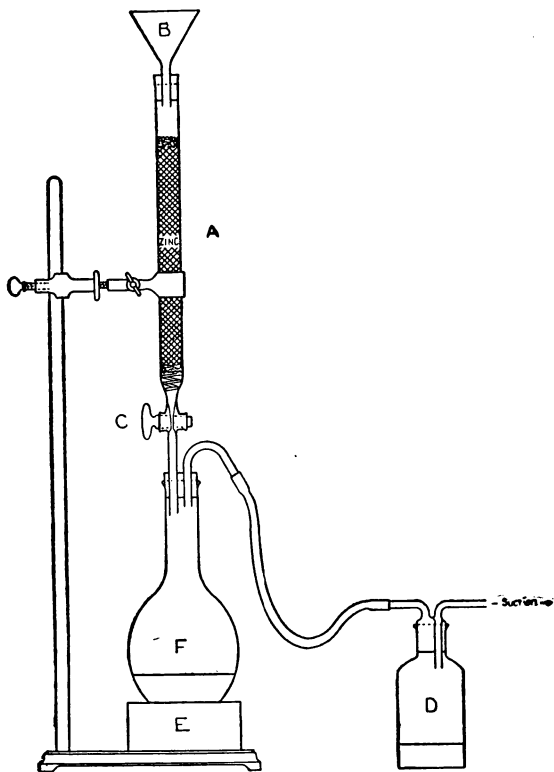

FIG. 91.

redissolved, and the phosphorus is precipitated in slightly acid solution as ammonium phosphomolybdate. The precipitate is dissolved in ammonia, the solution acidified with sulphuric acid

* Andrew Blair. The Chemical Analysis of Iron.

and the molybdenum reduced by means of a so-called *Jones reductor*. The reduced solution is titrated with permanganate.

The Jones reductor (Fig. 91) is made by placing a platinum spiral (or glass beads) in the bottom of a glass-stoppered tube which is 30 cm. long and has an inside diameter of 18 mm. Upon the spiral, or beads, is placed a plug of glass wool and then a thin layer of asbestos such as is used for Gooch crucibles. The tube is then filled with amalgamated zinc to within 5 cm. of the top. This zinc can be prepared by taking some 20- to 30-mesh zinc, cleaning it with a little hydrochloric acid, and adding mercuric chloride until hydrogen ceases to be evolved. In this condition the zinc is scarcely acted upon at all by hydrochloric acid, but is capable of reducing an iron or molybdenum solution just as effectively as if it were not amalgamated. On top of the column of zinc is placed a little glass wool to serve as filter.

Procedure.—A 2 gm.-sample is taken in the case of steels and 1 gm. in the case of cast irons. The metal is weighed into a 250-c.c. Erlenmeyer flask and dissolved in 100 c.c. of nitric acid (sp. gr. 1.13) which is prepared by mixing one volume of nitric acid (sp. gr. 1.42) with 3 volumes of water and then testing the gravity. A small funnel is placed in the neck of the flask and the solution heated until all the iron has dissolved and the nitrous fumes expelled. Ten c.c. of strong permanganate solution (15 gms. to the liter) are added and the boiling continued until the pink color of the permanganate disappears. The slight precipitate of manganese dioxide is dissolved by the addition of a little sodium sulphite solution. After filtering, 40 c.c. of ammonia (sp. gr. 0.96) are added, the solution is brought to a temperature of about 40° and treated with 40 c.c. of a freshly-prepared solution of ammonium molybdate.* The flask is then closed with a

* 100 gms. of pure molybdic acid (MoO_3) is stirred into 400 c.c. of cold distilled water, and 80 c.c. of concentrated ammonia added. The solution is filtered, and the filtrate slowly poured, with constant stirring, into a solution of 400 c.c. nitric acid (sp. gr. 1.42) in 600 c.c. of water. After the addition of 0.05 gm. of microcosmic salt, the solution is allowed to stand 24 hours and is then filtered.

solid rubber stopper and shaken vigorously for five minutes.* After allowing the precipitate to settle for a few minutes, it is filtered and washed promptly with acid ammonium sulphate solution (1000 c.c. water, 25 c.c. concentrated H_2SO_4 , and 15 c.c. strong ammonia), until the washings give no test for molybdenum when treated with a drop of yellow ammonium sulphide solution. The color obtained is compared with a similar amount of the wash water itself which has been treated with the same ammonium sulphide.

The ammonium phosphomolybdate precipitate is dissolved in a mixture of 5 c.c. concentrated ammonia (sp. gr. 0.90) and 20 c.c. of water, the filter washed with water and the filtrate treated with 10 c.c. of concentrated sulphuric acid. It is then run through the Jones reductor. A blank is run with the reductor before each series of determinations, using the same quantity of reagents. After a reductor has stood for some time, it should be well washed with dilute sulphuric acid, before even running a blank test.

In making blanks and in all determinations, the procedure is as follows: 100 c.c. of dilute sulphuric acid (25 c.c. concentrated acid to 1 liter of water) are run into the funnel, *B*, and the stop-cock *C* is opened, using a little suction. When only a little of the dilute acid remains in the funnel, the hot solution to be reduced is added and when this has nearly passed out of the funnel, it is followed by 250 c.c. of hot dilute sulphuric acid, washing out the original beaker with this acid and adding it in small portions. Finally 100 c.c. of water are passed through the reductor. At no time, however, should any air be allowed to enter, as it forms hydrogen peroxide and vitiates the result.

The reduced solution is titrated with tenth-normal permanganate.

The ammonium phosphomolybdate precipitate, $(\text{NH}_4)_3\text{PO}_4 \cdot 12\text{MoO}_3$, contains 12 molecules of MoO_3 to 1 atom of phosphorus. Although zinc reduces MoO_3 to Mo_2O_3 , there is a slight oxidation by the air in the flask, so that correct results are obtained by assuming a reduction to $\text{Mo}_{24}\text{O}_{37}$ and subsequent oxidation by the permanganate to MoO_3 again. Therefore during the titration the following reaction takes place:

* A different method for precipitating phosphorus is given in Appendix I.

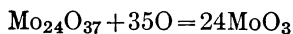

and



To illustrate the computation, let it be assumed that the ammonium phosphomolybdate precipitate from 2 gms. of a sample of steel requires by the above method 12 c.c. of permanganate solution, of which 1 c.c. = 0.00392 gm. Fe. The blank on the reductor was 0.18 c.c. The phosphorus present in the steel is then:

$$\frac{(12 - 0.18) \times 0.00392 \times \text{P} \times 100}{35\text{Fe} \times 2} = \text{per cent. phosphorus.}$$

Remarks.—The Jones reductor may be used to advantage for reducing sulphuric acid iron solutions which are to be titrated with permanganate. The blank experiment must always be made, as the zinc invariably contains a little iron. If in the above determination the reductor tube is prolonged so that it reaches nearly to the bottom of the flask, and dips into 50 c.c. of ferric alum solution (100 gms. ferric alum, 25 c.c. concentrated H_2SO_4 , 1000 c.c. water and 40 c.c. glacial H_3PO_4) the molybdenum comes in contact with this solution while it is entirely reduced to the trivalent condition. The ferric alum at once oxidizes the molybdenum to the hexavalent condition, and an equivalent amount of iron is reduced to the ferrous condition. The titration with permanganate can then be carried out, and in the computation the molecular weight of M_2O_3 is used instead of $\text{Mo}_{24}\text{O}_{37}$ as above and $1\text{P} = 36\text{H}$. The blank determination should be carried out with the ferric alum solution in the flask.

Concordant results can be obtained by both methods, but the latter has the advantage that there is no danger of some of the molybdenum being oxidized while shaking the flask during the titration.

In the case of steels containing tungsten and vanadium, the phosphorus may be left in the residue insoluble in nitric acid.

B. Potassium Dichromate Methods.

Determination of Iron according to the Method of Penny.

1000 c.c. N. $K_2Cr_2O_7 = 1$ gm.-at. Fe = 55.85 gms Fe.

Principle.—If a solution of a ferrous salt, in either hydrochloric or sulphuric acid, is treated with an alkali chromate solution, the chromate is at once reduced in the cold and the ferrous salt is oxidized quantitatively:



or

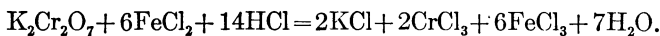

On account of the formation of the chromic salt the solution becomes emerald-green in color.

The end-point of the reaction is determined by removing a drop of the solution and testing it with a freshly-prepared solution of potassium ferricyanide; if no blue coloration is formed, the ferrous salt has been completely oxidized.

The $\frac{N}{10}$ potassium dichromate solution necessary for this titration may be prepared by dissolving $\frac{K_2Cr_2O_7}{60} = 4.903$ gms. of the salt, purified as described on p. 36, and dried at 130° C. It is not advisable to remove the last traces of moisture by melting the salt, for, either by overheating or by means of the dust of the air, there is some reduction of the chromate, so that subsequently a turbid solution will be obtained, containing small amounts of suspended Cr_2O_3 .

Method of Titration.—To the acid solution of the ferrous salt contained in a beaker (with about 0.1 to 0.15 gm. iron in each 100 c.c.) the solution of $\frac{N}{10} K_2Cr_2O_7$ is added, preferably from a glass-stoppered burette.

From time to time a drop of the solution is removed on the end of a glass stirring-rod to a white porcelain plate, and placed beside a drop of a not more than 2 per cent. solution of potassium ferri-

cyanide.* By means of a stirring-rod one solution is made to run into the other. If considerable ferrous salt remains in the solution, the blue color will be formed immediately, but in proportion as the ferrous salt is replaced by ferric salt, a bluish-green color is obtained, perceptible at the junction of the two solutions. As soon as no more bluish-green coloration is to be detected the reaction is complete. In all cases the analysis is made in duplicate, and, other things being equal, the second determination should be the more accurate. This time it is possible to add almost the whole of the required amount of bichromate at once, and for the testing not more than two or three drops of the dilute solution of ferrous salt. The loss of ferrous solution will then be inappreciable.

Remark.—The dichromate method is slightly less accurate than the permanganate method, but it possesses the advantage that a solution of a ferrous salt containing hydrochloric acid can be titrated without the addition of manganese sulphate, even when the solution is turbid with suspended insoluble salts, fibres of filter-paper, etc. In turbid solutions it is difficult to recognize the permanganate end-point. A further advantage lies in the fact that the normal dichromate solution can be readily prepared by simply weighing out the required amount of the pure, dry salt, and diluting the aqueous solution to a volume of 1 liter. It is then unnecessary to test the concentration in any other way.

Determination of Manganese in Iron and Steel. Method of J. Pattinson.†

Principle.—If a solution containing iron, manganese, and calcium salts is treated with “chloride of lime” solution and calcium carbonate, all of the iron and manganese are precipitated, the latter in the form of its hydrated dioxide. The whole precipitate is dissolved in an acid ferrous sulphate solution of known strength, and the excess of the latter is titrated with dichromate solution:

* The potassium ferricyanide must be absolutely free from ferrocyanide; and as the former is readily reduced by the dust of the air, the surface of the salt should be washed off several times with water before dissolving it for the test solution.

† Journ. of the Chem. Soc. (1879), p. 365.

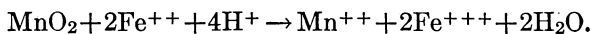

$$1000 \text{ c.c. N. K}_2\text{Cr}_2\text{O}_7 = 1\text{Fe} = \frac{\text{Mn}}{2} = \frac{54.93}{2} = 27.47 \text{ gms. Mn.}$$

Procedure.—5 gms. of the iron or steel (or 1 gm. of ferromanganese) are dissolved in hydrochloric acid, the solution oxidized with nitric acid, evaporated to a small volume, poured in a 100-c.c. measuring-flask, and diluted up to the mark with water. After thoroughly mixing, 20 c.c. of the solution are placed in a large beaker (of about 1 liter capacity) and neutralized with pure calcium carbonate. The carbonate is added in small portions until the solution finally becomes a dark brown but still remains clear. After this 50 c.c. of “chloride of lime” solution* are added, and more calcium carbonate with constant stirring until finally a little of the latter remains undissolved. To the slimy contents of the beaker 700 c.c. of hot water are added, and after stirring, the insoluble residue is allowed to settle, which requires but two or three minutes. If the supernatant liquid is violet, on account of the formation of calcium permanganate, one or two drops of alcohol are added, the liquid boiled, and the precipitate again allowed to settle; in this case the upper liquid should be colorless. If, perchance, it should be still colored, the treatment with the alcohol must be repeated. The clear solution is then decanted through a filter which is placed in a funnel containing a platinum cone and connected with a suction flask. The precipitate is decanted with 300 c.c. of hot water four times, then transferred to the filter without making any attempt to remove the last portions of the precipitate from the sides of the beaker, and washed with the aid of suction until the filtrate will no longer turn iodo-starch paper blue. The precipitate together with the filter is then placed in the original beaker in which the precipitation took place, 50 c.c. of a freshly-standardized ferrous sulphate solution containing sulphuric acid are added, and the liquid is stirred until the precipitate has entirely dissolved,† leaving behind the filter-paper and sometimes small amounts of undissolved calcium sulphate. The ex-

* Prepared by shaking 15 gms. of fresh bleaching powder with 1 liter of water and allowing the mixture to stand until the supernatant solution is clear.

† If the precipitate should not completely dissolve, a little sulphuric acid (1:1) is added until the brown color entirely disappears.

cess of the ferrous sulphate is titrated with potassium dichromate solution. In order to compensate any error that may arise from the presence of the filter-paper, an equally large filter is placed in the ferrous sulphate solution, when it is standardized.

The calculation is simple:

Assume that a gms. of steel are dissolved in 100 c.c. of the solution and of this 20 c.c. $\left(= \frac{a}{5} \text{ gms. steel} \right)$ were taken for the analysis; further, 50 c.c. of ferrous sulphate solution = T c.c. $\frac{N}{10}$ $\text{K}_2\text{Cr}_2\text{O}_7$ and 50 c.c. ferrous sulphate + $\frac{a}{5}$ gms. substance = t c.c. $\frac{N}{10}$ $\text{K}_2\text{Cr}_2\text{O}_7$. Consequently $\frac{a}{5}$ gms. substance = $(T-t)$ c.c. $\frac{N}{10}$ $\text{K}_2\text{Cr}_2\text{O}_7$.

Since 1000 c.c. $N. \text{K}_2\text{Cr}_2\text{O}_7$ solution = 27.47 gms. Mn, then 1 c.c. $\frac{N}{10}$ $\text{K}_2\text{Cr}_2\text{O}_7$ will correspond to 0.002747 gm. Mn, and we have

$$(T-t) \times 0.002747 \text{ gm. Mn in } \frac{a}{5} \text{ gms. steel and in per cent.}$$

$$\frac{(T-t) \times 1.374}{a} = \text{per cent. Mn.}$$

Remark.—According to the author's experience, this method is one of the best for the determination of manganese in iron and steel. As regards the time required, four determinations can be carried out together within four hours. It is not particularly suited to the analysis of alloys rich in manganese.

C. Iodimetry.

The fundamental reaction of iodimetry is the following:

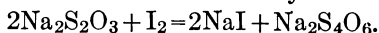

If to a solution containing an unknown amount of iodine a little starch solution is added, and sodium thiosulphate solution is run in from a burette, the blue color will disappear from the solution as soon as the iodine has all been reduced to hydriodic acid (sodium iodide) in accordance with the above equation. This reaction is one of the most sensitive reactions used in analytical chemistry. If, therefore, a sodium thiosulphate solution of known strength is at hand, we have a means of determining not only iodine itself, but all of those substances (oxidizing agents) which when treated with potassium iodide set free iodine, or evolve chlorine when acted upon by hydrochloric acid. Consequently, iodimetric processes are not only accurate but capable of most general appli-

cation. For most analyses a $\frac{N}{10}$ sodium thiosulphate solution and a $\frac{N}{10}$ iodine solution are required, and starch solution as indicator. In some few cases $\frac{N}{100}$ solutions are used.

Preparation of Sodium Thiosulphate Solution.

From the above equation it is evident that 1 gm.-at. I = 1 gm.-mol. $\text{Na}_2\text{S}_2\text{O}_3 = 1$ gm.-at. H. Hence, exactly $\frac{1}{10}$ gm.-mol. of crystallized sodium thiosulphate ($\text{Na}_2\text{S}_2\text{O}_3 + 5\text{H}_2\text{O}$) must be taken for 1 liter of tenth-normal solution. Such a solution, however, would rapidly change in concentration, some of the salt being decomposed by the action of the carbon dioxide in the distilled water:

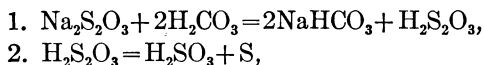

and the solution would become stronger, for the sulphurous acid formed reacts with more iodine than the corresponding amount of thiosulphate:

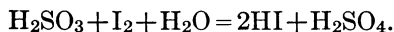

After all the carbonic acid in the distilled water has been used up, the solution can be kept for months without suffering an appreciable change in concentration (see p. 649).

A large amount of the thiosulphate solution (about 5 liters) is prepared by roughly weighing out the required amount of the commercial salt* and after standing for from eight to fourteen days, the solution is standardized by one of the following methods.

Standardization of Sodium Thiosulphate Solution.

1. With Pure Iodine.

Commercial iodine is contaminated with chlorine, bromine, water, and sometimes cyanogen; it must be purified. For this

* The molecular weight of $\text{Na}_2\text{S}_2\text{O}_3 + 5\text{H}_2\text{O}$ is 248.32. To prepare 1 liter of $\frac{N}{10}$ solution 24.832 gms. of the salt are necessary, or, in round numbers, 25 gms. For 5 liters, 125 gms. should be weighed out.

purpose 5 or 6 gms. of the commercial product are ground up with 2 gms. potassium iodide, and any chlorine or bromine present forms potassium chloride or bromide, setting free an equivalent amount of iodine. The mixture is placed in a dry casserole (Fig. 92)* which rests in a muffle. Upon the casserole

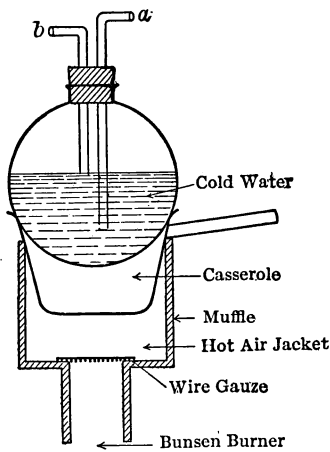

FIG. 92.

is placed a flask filled with cold water. A wire gauze is placed at the bottom of the muffle and a Bunsen flame beneath this. The iodine sublimes rapidly and collects as a crystalline crust on the bottom of the flask, and practically none of it is lost. As soon as the evolution of violet vapors from the bottom of the casserole has practically ceased, the sublimation is complete. The flame is removed, and after allowing to cool, the flask is removed with the iodine adhering to it. In order to remove the latter, a current of cold water is conducted through the tube *a* into the flask and out at *b*. This causes the

glass to contract somewhat and the whole of the iodine crust can be removed by lightly pushing it with a clean glass rod. It is caught upon a watch-glass, broken up into large pieces, and the sublimation is repeated without the addition of potassium iodide at as low a temperature as possible; in this way a product free from potassium iodide is obtained. The iodine thus prepared is ground somewhat in an agate mortar and dried in a desiccator containing calcium chloride. If dried over sulphuric acid, some of the latter is likely to be present in the iodine. Furthermore, the cover of the desiccator must not be greased, for grease is attacked by iodine vapors, forming hydriodic acid, which might cause contamination.

The Weighing Out of the Iodine.—In each of two or three small weighing-tubes with tightly-fitting glass stoppers are placed 2 to 2½ gms. of pure potassium iodide free from iodate and ½ c.c. of water (not more); the tubes are stoppered and accurately weighed by the method of swings. The tubes are then opened, 0.4–0.5 gm. of pure iodine is added to each, the tubes are quickly

* Cf. C. R. McCrosky, *J. Am. Chem. Soc.*, **40**, 1664 (1918).

stoppered and again weighed; the difference shows the amount of iodine. The iodine dissolves almost instantly in the concentrated potassium iodide solution. One of the tubes is then placed in the neck of a 500-c.c. Erlenmeyer flask which is held in an inclined position and contains 200 c.c. of water and about 1 gm. of potassium iodide. The tube is dropped to the bottom of the flask, but just as it begins to fall the stopper is removed and allowed to follow it. In this way there is no iodine lost, which will be the case if the contents of a tube are washed into the water.* A solution is thus prepared containing a known amount of iodine and to it the sodium thiosulphate solution to be standardized is added from a Mohr burette until the liquid is pale yellow in color. Now, 2 or 3 cc. of starch solution are added and the solution carefully titrated until it becomes colorless. From the mean of two or three determinations, the strength of the thiosulphate solution is calculated. For example, it was found that

- (a) 0.5839 gm. iodine required 50.07 c.c. $\text{Na}_2\text{S}_2\text{O}_3$ solution,
 or 1 c.c. = 0.011661 gm. iodine.
 (b) 0.5774 gm. " " 49.42 c.c. $\text{Na}_2\text{S}_2\text{O}_3$ solution,
 or 1 c.c. = 0.011683 gm. iodine.
-
- The mean value is 1 c.c. = 0.011672 gm. iodine.

If this number is divided by the amount of iodine which would be contained in 1 c.c. of normal iodine solution, the *normality* of the sodium thiosulphate solution will be obtained. Thus, in this case the solution is $\frac{0.011672}{0.012685} = 0.09201$ normal.

2. With Potassium Biiodate (C. Thom).†

If a solution of potassium biiodate is added to a solution of potassium iodide containing hydrochloric acid, the following reaction takes place:

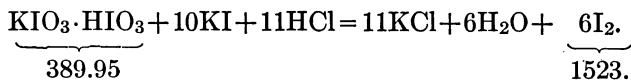

* Wagner first called attention to this fact, and it has been confirmed in the author's laboratory.

† Zeitschr. f. anal. Chem., XVI (1877), p 477.

If, therefore, 3.2496 gms. $\left(\frac{389.95}{120}\right)$ of pure potassium biiodate are contained in one liter of the aqueous solution, 10 c.c. of such a solution on being treated with an excess of potassium iodide and hydrochloric acid will set free exactly as much iodine as would be contained in 10 c.c. of $\frac{N}{10}$ iodine solution. By means of such a solution a known amount of iodine may be obtained at any time and in this way the solution of sodium thiosulphate may be standardized. At present it is possible to obtain commercially very pure potassium biiodate, but the product is seldom pure enough for the preparation of a $\frac{N}{10}$ solution. It is better to prepare a solution by weighing out 3.2496 gms. for 1 liter and determining the concentration accurately by titrating it against a solution of thiosulphate which has been freshly standardized against pure iodine. In this way a solution is obtained which can be conveniently used from time to time for testing the concentration of the thiosulphate solution.

Method of Titrating.—One or two grams of pure potassium iodide are placed in a beaker, dissolved in as little water as possible, and to this 5 c.c. of 6-normal hydrochloric acid, and then 20–25 c.c. of the biiodate solution are added (never in the reverse order). Iodine is liberated, immediately and quantitatively. After diluting with about 200 c.c. of distilled water, the iodine is titrated as under 1.

3. *With Potassium Permanganate (Volhard) **

On adding potassium permanganate solution to an acid solution containing potassium iodide, the permanganate is reduced to manganous salt, while an equivalent amount of iodine is set free from the iodide:

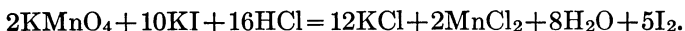

If an accurately-standardized solution of potassium permanganate is at hand, it can, therefore, be used advantageously for the standardization of the sodium thiosulphate solution. The procedure is the same as was described with the potassium biiodate solution.

* Ann. d. Chem. u. Pharm., 242, p. 98.

4. *With Potassium Dichromate.*

Similarly, an acid solution of potassium iodide (1:10) will, in the cold, quantitatively reduce chromic acid to green chromic salt, setting free an equivalent amount of iodine:*

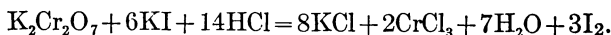

By weighing out 4.903 gms. of pure, dry potassium dichromate a tenth-normal solution is prepared and a measured amount of it is added to the acid solution containing about 3 gms. of potassium iodide and 10 c.c. strong hydrochloric acid. In this case, however, the solution is diluted with 500–600 c.c. of water, for here the color change is not from blue to colorless but from blue to light green.† With too concentrated solutions the end-point is indistinct, so that a considerable dilution is necessary.

Permanence of $\frac{\text{N}}{10}$ Sodium Thiosulphate Solutions.

A two-months-old sodium thiosulphate solution was standardized against pure iodine in June, 1899, and its concentration found to be

$$1 \text{ c.c.} = 0.011672 \text{ gm. I.}$$

In March, 1900, or about eight months later, the same solution of thiosulphate was again standardized and found to be

$$1 \text{ c.c.} = 0.011667.$$

At the end of eight months, therefore, the concentration of the solution was practically unchanged. Frequently the addition of ammonium carbonate is recommended in order to obtain a more permanent solution; it has the opposite effect.

Preparation of $\frac{\text{N}}{10}$ Iodine Solution.

There is no advantage to be obtained by dissolving the theoretical amount of sublimed iodine in a definite volume of solution,

* The solution should be quite acid with hydrochloric acid. In very dilute sulphuric acid solutions the chromic acid is reduced very slowly if at all.

† In all these methods starch solution is added toward the end of the reaction. See p. 647.

for the latter cannot be kept very long unchanged. It is more practical to prepare the iodine solution by placing 20-25 gms. of pure potassium iodide in a liter flask dissolving it in as little water as possible and then adding about 12.7 gms. of commercial iodine, weighed out roughly on a watch-glass. The contents of the flask are shaken until the iodine is all dissolved. When this is accomplished, the solution is diluted up to the mark with water and standardized according to one of the following methods.

1. With $\frac{N}{10}$ Sodium Thiosulphate Solution.

Of the thoroughly mixed iodine solution, 25 c.c. are titrated with the standard sodium thiosulphate solution.

If 25 c.c. of iodine solution require 25.16 c.c. of $\frac{N}{10}$ $\text{Na}_2\text{S}_2\text{O}_3$ solution, 1 c.c. of the former = 1.0064 c.c. of $\frac{N}{10}$ solution, or, in other words, the solution is 0.10064 normal.

2. With $\frac{N}{10}$ Arsenious Acid.

If iodine is allowed to act upon a solution of arsenious acid the reaction which takes place may be expressed as follows:

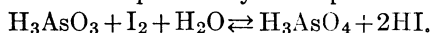

This reaction can be made to go completely in either directions according to the conditions.*

If the hydriodic acid is immediately removed from the solution as fast as it is formed, the reaction will proceed quantitatively in the direction from left to right. In the presence of sufficient hydrochloric acid, however, the reaction will take place completely in the opposite direction. When it is desired to make the oxidation of the arsenious acid quantitative, therefore, there should be but very little hydrogen ions in solution at any time; in other words, the solution must remain as nearly neutral as possible. The presence of free alkali is not permissible because any appreciable concentration of the hydroxyl ion reacts with iodine to form iodide, hypoiodite, and eventually iodate.

Alkali bicarbonates are without action upon iodine, so that

* E. W. Washburn, J. Am. Chem. Soc., 30. 21 (1908).

sodium bicarbonate is used for the neutralization of the hydriodic acid formed by the above reaction.

From the equation, it is evident that 1 gm.-at. I = $\frac{\text{As}_2\text{O}_3}{4} = \frac{198}{4} = 49.5$ gms. As_2O_3 , and $\frac{1}{10}$ gm.-at. I corresponds, therefore, to 4.95 gms. As_2O_3 = the amount necessary for 1000 c.c. of $\frac{N}{10}$ solution.

For the preparation of the $\frac{N}{10}$ arsenious acid solution, the vitreous form of commercial As_2O_3 is sublimed from a porcelain dish upon a watch-glass. If arsenic trisulphide is present (shown by a yellow sublimate being first formed) the preparation must be previously purified. For this purpose it is dissolved in hot hydrochloric acid (1:2), the insoluble sulphide filtered off, and the arsenic trioxide caused to deposit by cooling the filtrate. After pouring off the mother-liquor, the crystals are washed several times with water, dried on the water-bath, and the pure substance obtained by sublimation. After standing for twelve hours in a desiccator over calcium chloride, 4.95 gms. of the oxide are accurately weighed out into a porcelain dish and dissolved by warming with a little concentrated sodium hydroxide solution. After two or three minutes all will be dissolved. The solution is now poured through a funnel into a graduated liter flask, and the dish carefully washed out with water. A drop of phenolphthaleïn is added to the contents of the flask and pure dilute sulphuric acid until the solution is decolorized. About 20 gms. of sodium bicarbonate are dissolved in 500 c.c. of water and the filtered solution is added to the barely-acid contents of the flask. If the mixture reacts alkaline (shown by the red color of the phenolphthaleïn), a few drops of sulphuric acid are added until it becomes colorless, after which the solution is diluted up to the mark with water. After thoroughly mixing, a burette is filled with it and titrated against a measured amount of iodine solution as under 1.

3. *With Anhydrous Sodium Thiosulphate.**

Anhydrous sodium thiosulphate may be prepared in a state of sufficient purity to permit its use for standardizing iodine solutions. A saturated solution of the commercial salt is prepared at 30° to

* S. W. Young, J. Am. Chem. Soc., 26, 1028 (1904).

35° and then cooled while stirring constantly. The salt thus obtained is dehydrated over sulphuric acid until it has fallen to a powder, and a little of it in a test-tube shows no sign of fusion when heated to 50°. The final dehydration is effected by heating at 80° with repeated stirring of the powder.

Young standardized a solution of iodine by this method and obtained the same value as by titrating against a thiosulphate solution which had been standardized against pure iodine.

The Starch Solution.

About 5 gms. of powdered starch are rubbed into a paste with a little cold water, and the paste is slowly added to a liter of boiling water contained in a porcelain dish. The boiling is continued for one or two minutes so that an almost clear solution is obtained. The liquid is cooled by placing the dish in cold water, and after standing overnight the clear liquid is filtered into small 50-c.c. medicine bottles. These are placed in a water-bath and filled up to the neck with the starch solution, heated two hours, and closed by means of soft stoppers before removing from the hot-water bath. The solution thus sterilized can be kept almost indefinitely without the slightest trace of mould formation. Such a solution prepared according to the above directions by H. N. Stokes remained perfectly clear after standing 1½ years and was as sensitive then as when first made up. After opening the bottle, mould begins to form within one week, which explains why the solution is poured into small bottles; it may then be used before it becomes spoiled.

It is nowadays much more convenient to use the Zulkowsky "soluble starch," which is obtained commercially in the form of a paste. The reagent is prepared by dissolving a little of the paste in cold water.

Sensitiveness of the Iodo-Starch Reaction.

As already mentioned in Vol. I, p. 267, iodine produces a blue color with starch only when hydriodic acid or a soluble iodide is present, and further the formation of the blue color depends not only upon the presence of iodide but is largely influenced by the concentration of the iodide solution. With the same amount of iodide and different volumes of liquid quite different

amounts of iodine are necessary to produce the blue color. From this it is evident that in any iodimetric analysis about the same concentration should be maintained as in the case of the standardization of the solutions used for the analysis. When $\frac{N}{10}$ solutions are used, the error produced by not following this rule is a small one and for most purposes can be neglected. On the other hand, when an analysis is made with $\frac{N}{100}$ solutions, a large error may be introduced.

To show what the error can amount to, the following results will be given. To each of the following amounts of water, 1.5 c.c. of starch solution were added and then $\frac{N}{100}$ iodine solution until a barely-visible coloration was obtained.

c.c. Water.	$\frac{N}{100}$ Iodine Solution.
50	0.15 c.c.
100	0.30 "
150	0.47 "
200	0.64 "

These experiments were repeated using 3 c.c. of the starch solution with almost the same results. But when to each 1 gm. of potassium iodide was added, the following results were obtained:

Water.	$\frac{N}{100}$ Iodine Solution.
50 c.c. + 1 gm. KI	0.04 c.c.
100 " + 1 " "	0.04 "
150 " + 1 " "	0.04 "
200 " + 1 " "	0.14 "
500 " + 1 " "	0.32 "
500 " + 3 gms. "	0.32 "
620 " + 3 " "	0.32 "

The results show that the amount of iodine solution necessary

to produce the blue color in the absence of potassium iodide* is directly proportioned to the dilution. If the solution contains 1 gm. of potassium iodide, a blue color will be produced by the same amount of iodine solution as long as not more than 150 c.c. of solution are present, but with a greater volume than that, more iodine is necessary independent of whether the solution contains 1 gm. or more of potassium iodide.

In order to show the action of the iodide more distinctly, a very dilute iodine solution was added to 50 c.c. of water containing starch solution and in the absence of iodide, 15 c.c. were added before the blue color was permanent. After adding 1 gm. of potassium iodide, it was only necessary to add 1.5 c.c. of the dilute iodine.

When solutions were used without the addition of potassium iodide, the same amount of iodine solution (0.03 c.c.†) was necessary when not more than 300 c.c. of water were present. With 600 c.c. of water, 0.06 c.c. of iodine was necessary, and with 1000 c.c. it was found that 0.15 c.c. of iodine solution was required. On the other hand, when the solution contained 1 gm. of potassium iodide, only 0.06 c.c. of iodine was necessary in 1000 c.c. of liquid.‡

ANALYSES BY IODIMETRIC PROCESSES.

1. Determination of Free Iodine.

$$1000 \text{ c.c. } \frac{N}{10} \text{ iodine solution} = 12.692 \text{ gm. I.}$$

The iodine is dissolved in a solution of potassium iodide. The solution is titrated either with sodium thiosulphate or with arsenious acid exactly as described under the standardization of an iodine solution.

2. Determination of Chlorine in Chlorine Water.

$$1000 \text{ c.c. } \frac{N}{10} \text{ iodine solution} = 3.546 \text{ gm. Cl.}$$

* With the exception of the potassium iodide contained in the iodine solution itself.

† 0.03 c.c. = 1 drop.

‡ The temperature of the solution also exerts an influence. Other things being equal, the end-point is best obtained in a cold solution.—[Translator.]

A measured amount of chlorine water is added to a solution containing an excess of potassium iodide. The point of the pipette should be held just above the surface of the iodide solution and the latter should be contained in a glass-stoppered bottle. After the chlorine water has been added, the contents of the bottle are vigorously shaken, and the iodine set free is titrated with sodium thiosulphate as above:

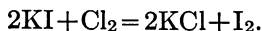

3. Determination of Bromine in Bromine Water.

1000 c.c. $\frac{N}{10}$ iodine solution = 7.992 gm. Br.

The procedure is the same as under 2:

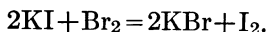

4. Determination of Hypochlorous Acid in the Presence of Chlorine.

The determination is based upon the following reactions:

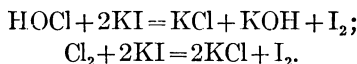

1 gm.-mol. of hypochlorous acid sets free 1 gm.-mol. of iodine, but produces at the same time 1 gm.-mol. of potassium hydroxide, while the chlorine simply sets free an equivalent amount of iodine. After neutralizing the alkali by means of an excess of hydrochloric acid and determining the iodine by titration with sodium thiosulphate, the excess of hydrochloric acid is titrated with standard alkali solution.

Procedure.—A measured volume of $\frac{N}{10}$ hydrochloric acid is added to a potassium iodide solution, to this a known amount of the mixture of chlorine and hypochlorous acid is added, and the iodine set free is titrated with $\frac{N}{10}$ thiosulphate solution. The now colorless solution is treated with methyl orange and the excess of hydrochloric acid is titrated with $\frac{N}{10}$ NaOH. The KOH produced by the action of the hypochlorous acid upon the iodide requires

half as much $\frac{N}{10}$ acid for neutralization as are required of $\frac{N}{10}$ $\text{Na}_2\text{S}_2\text{O}_3$ solution to react with the iodine set free by the action of the hypochlorous acid.

Example.—If V c.c. of chlorine + hypochlorous acid were taken for analysis, t c.c. $\frac{N}{10}$ HCl present at the start, T c.c. $\frac{N}{10}$ $\text{Na}_2\text{S}_2\text{O}_3$ used for titrating the iodine, and t_1 c.c. $\frac{N}{10}$ NaOH for titrating the excess of acid, then $t - t_1$ c.c. $\frac{N}{10}$ acid were required to neutralize the potassium hydroxide and $2(t - t_1)$ c.c. $\frac{N}{10}$ $\text{Na}_2\text{S}_2\text{O}_3$ to react with the iodine formed from the hypochlorite.

Hence $(t - t_1) 0.005247$ * = gm. HOCl in V c.c. solution and

$$T - 2(t - t_1) 0.003546 = \text{gm. Cl in } V \text{ c.c. solution.}$$

5. Determination of Iodine in Soluble Iodides.†

(a) By Decomposition with Ferric Salts.

If a solution of a soluble iodide is treated with an excess of iron-ammonium alum and acidified with sulphuric acid, the ferric salt will be reduced to ferrous salt with separation of iodine:

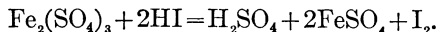

If the solution is heated to boiling, the iodine escapes with the steam and can be collected in a solution of potassium iodide and then titrated with sodium thiosulphate or arsenious acid. This method is suited for separating iodine from bromine, for bromides do not reduce ferric salts. The bromide will be found in the residue obtained after the distillation, and is best determined gravimetrically.

* $\text{HOCl} = 52.47$; 1 c.c. $\frac{N}{10}$ solution = 0.005247 gm. HOCl (against NaOH).

† In the case of insoluble iodides, the metal must first be removed if the iodine is to be determined volumetrically. This can be accomplished by the method of Mensel (*Z. anal. Chem.*, **12**, 137). It may be said, however, that the volumetric method offers no advantages over the gravimetric one.

(b) By Decomposition with Nitrous Acid (Fresenius).

This excellent method, which is especially suited for determining small amounts of iodine in the presence of bromine and chlorine in mineral waters, depends upon the easy oxidation of hydriodic acid by means of nitrous acid:

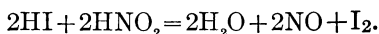

Hydrochloric and hydrobromic acids are not attacked by nitrous acid.

Procedure.—In the small apparatus shown in Fig. 93 the neutral or slightly alkaline solution of the iodide is placed; it is slightly acidified with dilute sulphuric acid, and a little freshly-distilled, colorless carbon bisulphide (or chloroform) is added, so that it does not quite reach to the stop-cock, near the bottom of the tube. Then two, or at the most three, drops of “nitrose”* are added, the tube stoppered and vigorously shaken, after which the carbon bisulphide is allowed to settle once more. The small amount of the latter which at first adheres to the glass sides is made to run to the bottom by revolving and inclining the tube. On the upper surface of the liquid there will still remain a few tiny drops of carbon bisulphide. To obtain these a funnel containing a filter moistened with water is placed under the glass stop-cock, the stopper is removed from the tube and the aqueous solution is allowed to run through the filter, but the carbon bisulphide will remain behind on the paper. The carbon bisulphide remaining in the tube is shaken three times with successive portions of distilled water, and each time the latter is allowed to run off through the same filter. The funnel is then placed at the top of the tube, punctured with a pointed glass rod, and the carbon bisulphide washed into the tube by means of about 0.5 c.c. of water. After



FIG 93.

washed into the tube by means of about 0.5 c.c. of water. After

* Cf. Vol. I, p. 285.

this one or two drops of sodium bicarbonate solution are added and thoroughly shaken with the carbon bisulphide, then standard sodium thiosulphate solution is added until the reddish-violet carbon bisulphide solution becomes colorless.

The value of the sodium thiosulphate solution is not determined as ordinarily, but by means of a potassium iodide solution treated as above described.

Remark.—This method is useful for determining small amounts of iodine in the presence of relatively large amounts of chlorine and bromine, as in the analysis of mineral waters. For the standardization of the sodium thiosulphate solution, as nearly as possible the same amount of potassium iodide is used as is present in the unknown solution; this is determined by the color of the carbon bisulphide. Pure potassium iodide must be used for this purpose, and its purity tested by means of a gravimetric determination of the iodine present in the salt after it has been dried at 170°–180° C.

The reason the sodium thiosulphate solution must be standardized in this way is as follows:

When an aqueous solution containing iodine is shaken with carbon bisulphide, not all of the iodine but the greater part of it will pass into the latter solvent.* The error is compensated, however, by standardizing the solution in the same way.

* If the solution of a substance is shaken with another solvent in which the former does not mix, the original amount of the substance divides itself between the two solvents, and in fact the concentration of one solution (amount of the dissolved substance present per cubic centimeter) always bears a constant relation to that of the other.

Thus if x_0 gms. of iodine are dissolved in V c.c. of water, and the solution is shaken with V_1 c.c. of carbon bisulphide, then x_1 gms. of iodine will remain in the aqueous solution and $x_0 - x_1$ gms. will pass into the carbon bisulphide.

The amount x is found by the following equation:

$$(1) \frac{x_1}{V} = \frac{x_0 - x_1}{V_1} k, \quad \text{and} \quad x_1 = x_0 \frac{kV}{V_1 + Vk}.$$

$\frac{x_1}{V}$ and $\frac{x_0 - x_1}{V_1}$ are the concentrations in each of the solutions and k is the *distribution coefficient*, which is $\frac{1}{100}$ for iodine.¹ If the aqueous solution is now shaken with the same amount of fresh carbon bisulphide, then x_2 gms. of

¹ Berthelot and Jungfleisch, *Comptes rend.*, 69, p. 338.

If, after shaking with carbon bisulphide, the aqueous solution still appears yellow, it must be treated a second, and perhaps a third, time with fresh amounts of carbon bisulphide.

6. Determination of Bromine in Soluble Bromides (Bunsen).

If chlorine water is added to a colorless bromide solution in a porcelain dish, the solution becomes yellow:

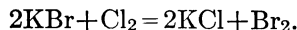

If it is heated to boiling, the bromine is expelled and the solution becomes colorless again. The addition of the chlorine water is continued until finally no yellow coloration is produced.

Preparation and Standardization of the Chlorine Water.

100 c.c. of a saturated chlorine water are diluted to 500 c.c. and titrated against a weighed amount of pure potassium bromide which has been dried at 170° C., the same amount of bromide being taken for the standardization as is supposed to be present in the solution to be analyzed. During the titration, the burette containing the chlorine water is enveloped in black paper to protect its contents from the light, and the tip of the burette is held

iodine will remain in the water and $x_1 - x_2$ will be extracted by the carbon bisulphide. In this case, however,

$$(2) \quad x_2 = x_0 \left(\frac{kV}{V_1 + V_1k} \right)^2 \text{ gms. iodine,}$$

so that after shaking n times with fresh portions of carbon bisulphide, the amount of iodine remaining in the water would be:

$$(3) \quad x_n = x_0 \left(\frac{kV}{V_1 + V_1k} \right)^n \text{ gms. iodine.}$$

Assuming that in the analysis 0.005 gm. of iodine was dissolved in 10 c.c. of water and that this solution was shaken once with 1 c.c. of carbon bisulphide, then according to equation (1)

$$x_1 = 0.005 \frac{\frac{1}{400} \times 10}{1 + \frac{10}{400}} = 0.005 \cdot \frac{1}{41} = 0.0001 \text{ gm. iodine}$$

would remain dissolved in the water, or an amount that can be neglected.

just above the surface of the hot bromide solution, so that as little chlorine as possible is lost by evaporation.

7. Determination of Iodine and Bromine in Mineral Waters.

According to the amount of halogen present, from 5 to 60 liters of water are taken for the analysis.

The amount of bromine and iodine present is usually small compared with the chlorine, so that the residue obtained by the evaporation of a large amount of water cannot be used directly for the analysis, but by partial crystallization a mother-liquor rich in bromide and iodide must first be obtained.

Procedure.—The water is placed in a large porcelain evaporating-dish, a liter at a time, and if not already alkaline,* enough pure sodium carbonate solution is added to make it distinctly so, and the water is evaporated to about one-fourth of its original volume. This causes the separation of some calcium and magnesium carbonates in the presence of hydroxides of iron and manganese, while all of the halogen salts remain in solution. The residue is filtered off and thoroughly washed with water. The filtrate is further concentrated until salts begin to crystallize out, and the hot solution is then poured into three times its volume of absolute alcohol; this causes the greater part of the sodium chloride and other undesired salts to precipitate. After standing twelve hours, the alcoholic liquid is filtered and the residue washed five or six times with 95 per cent. alcohol.

The alcoholic solution, which contains all of the iodine and bromine with considerable chlorine in the form of the alkaline salts, is treated with five drops of concentrated potassium hydroxide solution and almost all of the alcohol distilled off, while a current of air is passed through the solution by means of a capillary tube reaching to the bottom of the liquid in the distilling-flask.

The residue from the distillation is further concentrated until salts again begin to crystallize out and the precipitation with alcohol is repeated. The alcohol is again distilled off, but this time with the addition of only one or two drops of potassium hydroxide

* The solution is alkaline if after the addition of phenolphthalein the solution turns red on boiling.

solution. According to the amount of salts present in solution this operation is repeated from three to six times. The final filtrate, after the alcohol has been distilled off, is placed in a platinum dish, evaporated to dryness, the dish covered with a watch-glass, and the residue gently ignited to destroy organic matter. The residue from the ignition is dissolved in a little water, the carbonaceous material filtered off,* the solution slightly acidified with dilute sulphuric acid, the iodine liberated by the addition of one or two drops of "nitrose," and titrated with sodium thio-sulphate, after shaking with chloroform, as described on p. 657.† The bromine is determined in the aqueous solution obtained after the extraction of the iodine with chloroform. The acid solution is made alkaline by the addition of sodium carbonate solution, two drops of a saturated sugar solution are added, and the solution evaporated to dryness in a platinum dish. With a watch-glass upon the dish, the residue is gently ignited in order to destroy the sugar and the excess of nitrite.‡ After this has been accomplished the residue is dissolved in water, filtered, acidified slightly with sulphuric acid, and the bromine titrated with chlorine water as described on p. 659.

Remark.—If sufficient mineral water is available it is better to divide the mother-liquor containing the bromide and iodide into two portions; in one portion the iodine is determined as before, while in the other the bromine and iodine are determined by titration with chlorine water.§

8. Analysis of Peroxides (Bunsen).

All peroxides of the heavy metals, which evolve chlorine on treatment with hydrochloric acid, can be determined with great

* If the filtrate is not completely colorless, it is evaporated and again ignited.

† Lecco determines the iodine colorimetrically (*Zeitschr. f. anal. Chem.*, XXXV, p. 318).

‡ The addition of the sugar causes the nitrite to be destroyed at a lower temperature than would otherwise be the case, and the danger of losing bromine by volatilization is avoided.

§ As the chlorine water was standardized against bromine, an amount of the latter equivalent to the iodine present is deducted from the amount represented by the chlorine water used; the difference shows the bromine present.

accuracy by conducting the chlorine into potassium iodide solution and titrating the deposited iodine with sodium thiosulphate or arsenious acid solution. It is only necessary to make sure that the chlorine is allowed to act upon the potassium iodide without loss. For all such determinations, Bunsen employed the apparatus shown in Fig. 94. The small decomposition-flask of about 40 c.c. capacity has a ground-glass connection with the delivery-

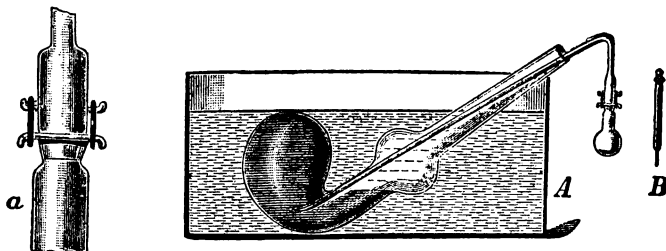

FIG. 94.

tube * and is held firmly in place by means of rubber rings, as at *a*. The lower end of the bent delivery-tube is drawn out into a not-too-small capillary.

Procedure.—The finely-powdered substance is placed in the small glass-stoppered weighing-tube (Fig. 94 *B*), which has a small piece of glass fused on the end, and weighed. The tube is then taken hold of by means of the glass at the bottom, † introduced into the neck of an absolutely dry decomposition-flask, and the required amount of the substance is allowed to fall into it by carefully revolving the weighing-tube. On again weighing the tube, the amount of substance taken is determined. Hydrochloric acid is now added (its concentration depends upon the nature of the substance), the delivery tubing is at once connected with the flask and introduced into the retort containing potassium iodide solution. By means of a tiny flame, the contents of the flask are heated to boiling and from half to two-thirds of the liquid

* Instead of the ground-glass connection, Bunsen used a tube of the same size as the neck of the flask and connected them with rubber tubing, the two glass tubes being against one another.

† By holding the tube in this way, deviations of weight, due to unequal warming, are avoided.

is distilled over into the retort. In order to prevent the iodide solution from sucking back into the flask, the delivery-tube is taken out of the retort before removing the flame; the contents of the tube are then washed into the retort.

The potassium iodide solution is poured into a large beaker, the retort washed out several times with a little water, and then with potassium iodide solution in order to remove any iodine which may remain adhering to the glass. The iodine is titrated with $\frac{N}{10}$ sodium thiosulphate solution. In this way pyrolusite, chromates, lead peroxide, minium, ceric oxide, selenic, telluric, and molybdic acids may be analyzed.

(a) Determination of Manganese Dioxide in Pyrolusite.

$$1000 \text{ c.c. } \frac{N}{10} \text{ Na}_2\text{S}_2\text{O}_3 \text{ solution} = \frac{\text{MnO}_2}{20} = \frac{86.93}{20} = 4.347 \text{ gms. MnO}_2.$$

How much pyrolusite shall be taken for the analysis? *

If possible, an amount should be taken for analysis which will not require more than one buretteful of the $\frac{N}{10}$ $\text{Na}_2\text{S}_2\text{O}_3$ solution.

We assume that the sample contains 100 per cent. of MnO_2 , and calculate how much of the latter would correspond to 50 c.c. of

$\frac{N}{10}$ $\text{Na}_2\text{S}_2\text{O}_3$:

$$1 \text{ c.c. } \frac{N}{10} \text{ solution} : 0.004347 \text{ gm. MnO}_2 = 50 : x;$$

$$x = 50 \times 0.004347 = 0.2173 \text{ gm. MnO}_2.$$

Consequently for the analysis about 0.2 gm. of the substance is taken, which has been dried at 100°C . To this 25 c.c. of hydrochloric acid (1:2) are added and the analysis is made as described above.

* This is applicable to almost every volumetric analysis. To insure the most accurate results, the concentration of the standard solution and the weight of substance taken for analysis should be so chosen that between 35 and 50 c.c. of the reagent are used in the final titration. In this way the errors in determining the end-point, reading the burette, etc., will not influence the result appreciably.—[Translator.]

The calculation is based upon the following equations:

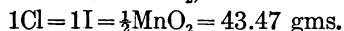
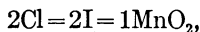

The amount of substance taken for analysis = a gms., and the $\frac{N}{10}$ $\text{Na}_2\text{S}_2\text{O}_3$ solution used for the titration of the iodine = t c.c. Then

$$a : t \times 0.004347 = 100 : x;$$

$$x = \frac{0.4347 \cdot t}{a} = \text{per cent. MnO}_2.$$

The determination of chromates, lead peroxide, and selenic acid is carried out in the same way, except that concentrated hydrochloric acid is used for the decomposition.

(b) Determination of Telluric Acid.

If the telluric acid is present as the hydraous acid ($\text{H}_2\text{TeO}_4 + 2\text{H}_2\text{O}$) or as tellurate, the analysis is performed in the same way as with selenic and chromic acids. If, however, the tellurium is present as the anhydrous acid or as the anhydride, the method must be modified, for these substances are scarcely attacked by concentrated hydrochloric acid. They are placed in the decomposition-flask, dissolved in a little concentrated potassium hydroxide,* and to the tellurate solution thus obtained the concentrated hydrochloric acid is added; the reduction then is accomplished without difficulty:

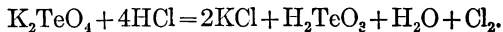

According to this equation

$$1\text{Cl} = 1\text{I} = \frac{\text{Te}}{2} = \frac{127.5}{2} = 63.75 \text{ gms. Te.}$$

* The solution could not be effected by using *sodium* hydroxide.

c) Determination of Ceric Oxide.

$$1000 \text{ c.c. } \frac{N}{10} \text{ iodine solution} = \frac{\text{CeO}_2}{10} = \frac{172.25}{10} = 17.225 \text{ gms. CeO}_2.$$

Ceric oxide when mixed with considerable lanthanum and didymium oxides is reduced by distillation with concentrated hydrochloric acid:



If, however, the mixture contains but little of the two last substances, or if it is pure ceric oxide, the heating with concentrated hydrochloric acid is of no avail; the ceric oxide will not dissolve.

In the presence of hydriodic acid, however, the reduction takes place readily, so that it is only necessary to add 2 gms. of potassium iodide to a weighed amount of the substance (0.67-0.68 gm.) in the decomposition-flask, and then, after the addition of hydrochloric acid, violet vapors of iodine can be distilled from the solution:



Often there will be so much iodine given off that the solid is likely to stop up the tube and the flask will often explode. To prevent this, the end of the delivery-tube is not drawn out into a capillary, but at the bottom an opening of about 4 mm. in diameter is left. During the operation, the flame must be protected from air-currents, for otherwise there is danger of liquid sucking back from the retort.

(d) Determination of Vanadic Acid. †

$$1000 \text{ c.c. } \frac{N}{10} \text{ iodine solution} = \frac{\text{V}_2\text{O}_5}{20} = \frac{182.4}{20} = 9.12 \text{ gms. V}_2\text{O}_5.$$

By boiling vanadic acid, or one of its salts, with concentrated hydrochloric acid, the vanadium is reduced with evolution of chlorine. Unfortunately, this reaction cannot be used for the determination of vanadic acid, for the amount of chlorine evolved

depends upon the concentration of the vanadium solution; the vanadium is not reduced to a definite oxide. On the other hand, by means of *hydrobromic acid*,* vanadic acid is reduced to a blue vanadyl salt:

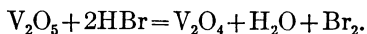

If the free bromine is absorbed in potassium iodide, and the liberated iodine titrated with sodium thiosulphate, a sharp determination of the vanadium will be obtained. To carry out this analysis, about 0.3–0.5 gm. of the vanadate, together with 1.5 to 2 gms. of potassium bromide, is placed in the decomposition-flask of the Bunsen apparatus (Fig. 94, p. 662), 30 c.c. of concentrated hydrochloric acid are added, and distillation is effected as before. The decomposition is always complete when the liquid in the flask is a pure blue.

If hydriodic acid is used instead of hydrobromic acid, the vanadic acid is reduced still further, almost to V_2O_3 .† In fact, a complete reduction to the latter oxide can be accomplished if potassium iodide, concentrated hydrochloric acid, and 1 or 2 c.c. of syrupy phosphoric acid are added and the liquid distilled until no more vapors of iodine are evolved. According to Steffan, this will always be the case when the liquid is reduced to one-third of its original volume.

(e) **Determination of Molybdic Acid.**

$$1000 \text{ c.c. } \frac{\text{N}}{10} \text{ Na}_2\text{S}_2\text{O}_3 = \frac{\text{MoO}_3}{10} = \frac{144}{10} = 14.4 \text{ gms. MoO}_3.$$

The determination depends upon the fact that molybdic acid is reduced to molybdenum pentoxide by means of hydriodic acid with liberation of iodine:

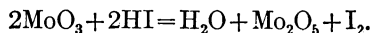

Remark.—This method finds no practical application on account of the fact that it is difficult to obtain a quantitative reduction in

* Holverscheidt, Dissertation, Berlin, 1890.

† Friedheim and Euler, *Berichte*, 28 (1895), 2067.

‡ *Ibid.*, 28 (1895), 2067, and 29 (1896), 2981.

accordance with the above equation. Gooch and Fairbanks* found that if a solution containing molybdic acid is distilled in the Bunsen apparatus with potassium iodide and hydrochloric acid, until iodine vapors are no longer visible and the solution is a light green, too little iodine is obtained. On the other hand, if the distillation is continued still further, they found that the reduction goes on and more iodine is obtained than corresponds to the above equation. Steffan,† who tested the method in the author's laboratory, obtained results agreeing with those published by Gooch and Fairbanks. By means of *hydrobromic* acid, molybdic acid is not reduced.

(f) **Determination of Vanadic and Molybdic Acids in the Presence of One Another.**

According to Steffan, these two acids may be determined very accurately when present together. The vanadic acid is determined, according to Holverscheidt, by distillation with potassium bromide and concentrated hydrochloric acid, absorption of the bromine in potassium iodide solution, and titration of the liberated iodine (cf. p. 666). The contents of the distillation flask, in which the vanadium is present as vanadyl salt and the molybdenum as molybdic acid, are treated with hydrogen sulphide in a pressure-flask, and the precipitated molybdenum sulphide is filtered through a Gooch crucible, and weighed as MoO_3 , as described on p. 286. The results obtained by this method are perfectly satisfactory.

As molybdic acid is unattacked by hydrobromic acid, but is reduced to Mo_2O_3 with separation of iodine by means of hydriodic acid, Friedheim and Euler proposed the following method for the determination of vanadic and molybdic acids when present together:

The mixture of the two acids is distilled as before with potassium

* Gooch and Fairbanks, *Zeitschr. f. anorg. Chem.*, XIII (1897), 101, and XIV, 317.

† Steffan, *Inaug. Dissertation*, Zurich, 1902.

bromide and hydrochloric acid and the vanadium thereby reduced to the tetroxide compound

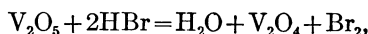

with separation of two atoms of bromine which are determined iodimetrically. To the cold solution remaining in the distilling-flask, potassium iodide, hydrochloric acid, and syrupy phosphoric acid are added, and the distillation continued until no more iodine is given off and the solution is a light green.

By means of this second reduction the vanadium tetroxide is supposed to be reduced to V_2O_3 ,

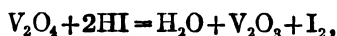

and consequently more iodine is liberated by the vanadium. Furthermore, according to Friedheim and Euler, the molybdenum is reduced to Mo_2O_5 :

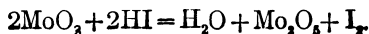

If, therefore, the amount of iodine corresponding to the first titration is deducted from the amount obtained in the second, the difference should correspond to the amount of molybdenum present. But Gooch and Fairbanks have shown that this is not the case.*

The error in the method lies in the fact that the vanadic acid is only reduced completely to V_2O_3 when the solution is distilled to one-third of its original volume. In this case, however, the molybdenum is reduced further than corresponds to the formation of Mo_2O_5 ; too much iodine is liberated and too high a value is obtained for the molybdic acid present. On the other hand, if after the addition of the potassium iodide the liquid is only distilled until the iodine vapors cease to appear and the solution is a light green, the vanadium is not completely reduced to V_2O_3 , and then a too low value for the molybdenum is obtained.

* The results of Gooch and Fairbanks have been confirmed in every respect by Steffan.

9. Analysis of Chlorates.

This is carried out the same way as the analysis of pyrolusite (cf. p. 663):

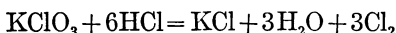

$$\frac{1}{10} \text{ gm.} = \text{at. iodine} = 1000 \text{ c.c.} \frac{\text{N}}{10} \text{ Na}_2\text{S}_2\text{O}_3 \text{ solution}$$

$$= \frac{\text{KClO}_3}{60} = \frac{122.6}{60} = 2.043 \text{ gms. KClO}_3.$$

Many oxidizing agents can be determined iodimetrically without previous distillation with hydrochloric acid.

For other methods of analyzing chlorates iodimetrically, consult H. Ditz, *Chem.-Ztg.* **1901**, 727 and Luther and Rutter, *Z. anal. Chem.* **46**, 521 (1907).

10. Determination of Hypochlorous Acid.

This determination is made use of in the analysis of chloride of lime.

Procedure.—Into a tared weighing-tube about 5 gms. of “chloride of lime” are introduced, and the stoppered tube is weighed. Its contents are washed into a porcelain dish, rubbed to a paste by means of a pestle, and then transferred without loss to a 500-c.c. measuring-flask, diluted up to the mark with water and well shaken. Of this turbid solution, 20 c.c. are run into 10 c.c. of 10 per cent. potassium iodide solution, and after acidifying with hydrochloric acid the iodine set free is titrated with $\frac{\text{N}}{10} \text{ Na}_2\text{S}_2\text{O}_3$. The result is expressed in per cent. of chlorine.

Remark.—If the “chloride of lime” contained calcium chlorate it will be partially reduced by hydrochloric acid and potassium iodide with liberation of iodine, and consequently the results obtained for hypochlorite chlorine (bleaching chlorine) will be too high. In this case the hypochlorite is best determined by a chlorimetric process with arsenious acid (see p. 701).

11. The Analysis of Iodates.

$$1000 \text{ c.c. } \frac{N}{10} \text{ Na}_2\text{S}_2\text{O}_3 = \frac{\text{HIO}_3}{60} = \frac{175.93}{60} = 2.932 \text{ gms. HIO}_3.$$

The solution of the iodate is allowed to run into an acid solution containing an excess of potassium iodide. Iodine is set free according to the equation

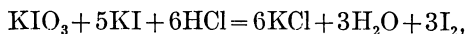

and the iodine is titrated with thiosulphate solution as described on p. 647.

12. The Analysis of Periodates.

$$1000 \text{ c.c. } \frac{N}{10} \text{ Na}_2\text{S}_2\text{O}_3 = \frac{\text{HIO}_4}{80} = \frac{191.93}{80} = 2.399 \text{ gms. HIO}_4.$$

The analysis of periodates is carried out exactly as with iodates; the reaction that takes place is

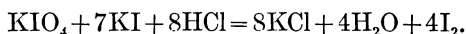
**13. Analysis of a Mixture of Iodate and Periodate.***

If a neutral or slightly alkaline solution of an alkali periodate is treated with a solution of potassium iodide, the following reaction takes place:

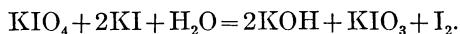

The liberated iodine is titrated with tenth-normal arsenious acid (not with sodium thiosulphate); in a neutral solution the *iodate* does not react with potassium iodide. For the analysis of a mixture of iodate and periodate, the following procedure is used:

In one sample the iodate + periodate is determined by adding the solution of the substance to an acid solution containing an excess of potassium iodide and the liberated iodine is titrated with sodium thiosulphate solution.

A second sample of the substance is dissolved in water, a drop

* E. Müller and O. Friedberger, *Berichte*, 1902, 2655.

of phenolphthalein added, and the solution is made just alkaline enough to give the pink color with phenolphthalein, adding alkali if the solution is acid and hydrochloric acid if the solution is strongly alkaline. To the barely alkaline solution, 10 c.c. of a cold, saturated solution of sodium bicarbonate are added and then an excess of potassium iodide; the liberated iodine is at once titrated with tenth-normal arsenious acid.*

Example.—In a mixture of KIO_3 and KIO_4 weighing a grams, the iodine liberated on treatment with an acid solution of KI reacts with T c.c. of 0.1 N $\text{Na}_2\text{S}_2\text{O}_3$ and the same weight of sample liberates in alkaline solution only enough iodine to react with t c.c. of 0.1N As_2O_3 solution. By comparing the equations given under 12 and 13, it is evident that the periodate alone would react with $4t$ c.c. of 0.1N $\text{Na}_2\text{S}_2\text{O}_3$ in acid solution. The amount of KIO_4 and KIO_3 present will be

$$t \times 0.01150 \text{ gm.} = \frac{t \times 1.150}{a} \% \text{ KIO}_4,$$

$$(T - 4t) \times 0.003567 \text{ gm.} = \frac{(T - 4t) \times 0.3567}{a} \% \text{ KIO}_3.$$

14. Analysis of Iodides. †

Method of H. Dietz and B. M. Margosches.

$$1000 \text{ c.c. } \frac{\text{N}}{10} \text{ KIO}_3 = \frac{5\text{I}}{60} = \frac{5 \times 126.9}{60} = 10.58 \text{ gm. iodine.}$$

The solution of the iodide is treated with an excess of tenth-normal potassium iodate solution, acidified with hydrochloric acid, a piece of calcite added, as suggested by Prince, ‡ and boiled until all the iodine is expelled. The solution is allowed to cool, then an excess of potassium iodide is added, and the iodine now

* The iodine cannot be titrated in the alkaline solution with sodium thiosulphate, and the iodine in the acid solution cannot be titrated with the arsenious acid.

† Chem. Ztg., 1904, II, 1191.

‡ Jaug. Dissert. Zürich, 1910.

liberated, which corresponds to the excess of potassium iodate used, is titrated with tenth-normal $\text{Na}_2\text{S}_2\text{O}_3$ solution.

From the equation

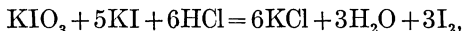

it is evident that five-sixths of the iodine liberated comes from the iodide. If, therefore, T c.c. of 0.1N KIO_3 solution were added and t c.c. of 0.1N $\text{Na}_2\text{S}_2\text{O}_3$ were used for titrating the excess of KIO_3 , then there is present

$$(T-t) \times 0.01058 \text{ gm. iodine as iodide.}$$

15. Determination of Copper with Potassium Iodate.*

Potassium iodate in dilute hydrochloric acid solution is reduced by potassium iodide to free iodine (cf. p. 670):

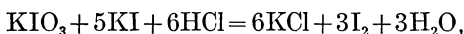

but if the solution is strongly acid with hydrochloric acid and an excess of the iodate is added, the iodine is oxidized to ICl :

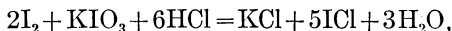

and in this case the whole reaction may be expressed by the equation:

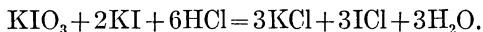

The ICl is not very stable, and is at once reduced to free iodine in the presence of any oxidizable substance.

L. W. Andrew † has shown that quite a number of reducing substances, such as free iodine, iodides, arsenites, and antimonites, can be titrated with potassium iodate very exactly, by taking advantage of the fact that when the reducing agent is present in excess free iodine is formed, which is oxidized quantitatively by more iodate, provided the proper amount of hydrochloric acid is present. Copper solutions are precipitated quantitatively

* Jamieson, Levy, and Wells, *Jour. Am. Chem. Soc.*, **30**, 760 (1908).

† *Ibid.*, **25**, 756 (1903).

by potassium thiocyanate and sulphurous acid as cuprous thiocyanate, CuSCN , and Parr* has estimated copper quantitatively by titrating this precipitate with permanganate. The oxidation is, however, simpler and more accurate when the titration is effected by potassium iodate, or biiodate. The reaction goes through the stage in which iodine is set free, but the latter is oxidized completely to iodine chloride upon the addition of more iodate:

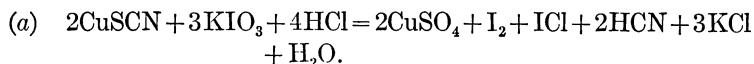

and the whole reaction is (multiplying (a) by 2 and adding (b)),

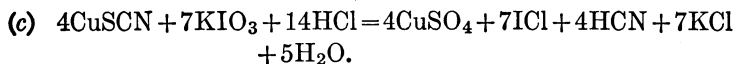

The potassium iodate solution is very stable and can be preserved for years if protected from evaporation. The standard solution used can be prepared by weighing out a known amount of the pure salt and dissolving to a definite volume, or the solution may be standardized against pure copper, carrying out the process as in an analysis. A convenient concentration is one-fifth of the formula weight.

Procedure.—To 0.5 gm. of the ore in a 200 c.c. flask, add 6 to 10 c.c. of strong nitric acid, and boil gently, best over a free flame, keeping the flask in constant motion and inclined at an angle of about 45° , until the larger part of the acid has been removed. If this does not completely decompose the ore, add 5 c.c. of strong hydrochloric acid and continue the boiling until the volume of liquid is about 2 c.c. Now add gradually and carefully, best after cooling somewhat, 12 c.c. of sulphuric acid (1 : 1), and continue the boiling until sulphuric acid fumes are evolved copiously. Allow to cool, add 25 c.c. of cold water, heat to

* J. Am. Chem. Soc., 22, 685 (1900).

boiling, and keep hot until the soluble sulphates have dissolved. Filter into a beaker, and wash the flask and filter thoroughly with cold water.* Nearly neutralize the filtrate with ammonia and add 10 to 15 c.c. of strong sulphur dioxide water. Heat just to boiling and add 5 to 10 c.c. of a 10 per cent. solution of ammonium thiocyanate, according to the amount of copper present. Stir thoroughly, allow the precipitate to settle for 5 or 10 minutes, filter on paper, and wash with hot water until the ammonium thiocyanate is completely removed.

Place the filter with its contents in a glass-stoppered bottle of about 250 c.c. capacity, and by means of a piece of moist filter-paper transfer into the bottle also any precipitate adhering to the stirring-rod and beaker. Add to the bottle about 5 c.c. of chloroform, 20 c.c. of water and 30 c.c. of concentrated hydrochloric acid (the two latter liquids may be previously mixed). Now run in standard potassium iodate solution, inserting the stopper and shaking vigorously between additions. A violet color appears in the chloroform, at first increasing and then diminishing, until it disappears with great sharpness. The rapidity with which the iodate solution may be added can be judged from the color changes of the chloroform.

In order to make another titration it is not necessary to wash the bottle or throw away the chloroform. Pour off two-thirds or three-fourths of the liquid in order to remove most of the pulped paper, too much of which interferes with the settling of the chloroform globules after agitation, add enough properly diluted acid to make about 50 c.c. and proceed as before. In this case, where iodine monochloride is present at the outset, the chloroform becomes strongly colored with iodine as soon as the cuprous thiocyanate is added, but this makes no difference with the results of the titration.

* With substances containing appreciable amounts of silver a few drops of hydrochloric acid should be added before making this filtration, but not enough to dissolve any considerable amounts of the lead sulphate or antimonic oxide that may be present.

16. Analysis of Soluble Chromates.

A concentrated, acid solution of potassium iodide is treated with a weighed amount of the chromate, diluted with water, and the liberated iodine titrated. (Cf. standardization of sodium thiosulphate against potassium dichromate, p. 649.)

16a. Determination of Chromium in Chromite.

About 0.2 gm. of the finely powdered chromite is intimately mixed with 2 gms. of sodium peroxide in a porcelain crucible. This crucible is placed inside a larger porcelain crucible and heated for fifteen or twenty minutes over a small flame.* At the end of this time, all the chromium will be converted into soluble sodium chromate. The crucible and its contents are placed in 100–200 c.c. of water, which is heated to boiling and kept at this temperature until the melt is completely disintegrated. The ferric oxide is then filtered off, the filtrate evaporated in a porcelain dish nearly to dryness,† the residue taken up in as little water as possible, 10 c.c. of concentrated hydrochloric acid and one or two grams of potassium iodide added, the solution diluted to about 400 c.c., and the free iodine titrated with tenth-normal thiosulphate solution:

$$1 \text{ c.c. } \frac{N}{10} \text{ Na}_2\text{S}_2\text{O}_3 = 0.001733 \text{ gm. Cr.}$$

17. Determination of Lead Peroxide.

Method of Diehl, modified by Topf.‡

The analysis depends upon the fact that lead peroxide is reduced by means of potassium iodide in acetic acid solution when considerable alkali acetate is present:

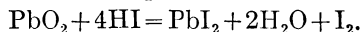

After diluting with water the iodine is titrated with $\frac{N}{10}$ $\text{Na}_2\text{S}_2\text{O}_3$ solution.

* If the crucible is heated too hot, it is likely to be strongly attacked by the sodium peroxide. With care, a single crucible may be used for four or six determinations.

† The evaporation to dryness is necessary to remove the last traces of peroxide.

‡ Diehl, *Dingl. polyt. Journ.*, **246**, p. 196, and Topf, *Zeitschr. f. analyt. Chem.*, **XXVI** (1887), p. 296.

Procedure.—About 0.5 gms. of the substance are dissolved with 1.2 gms. of potassium iodide and 10 gms. of sodium acetate in 5 c.c. of 5 per cent. acetic acid. The solution is diluted with water to a volume of 25 c.c. and titrated with sodium thiosulphate.

Remark.—Moist lead peroxide reacts almost instantly on undergoing the above treatment; thoroughly dried material, on the other hand, dissolves after a few minutes provided it is finely ground. If, however, the dry peroxide is in the form of coarse grains, it may be several hours before the reaction is finished, or the decomposition may be incomplete.

Furthermore, too much potassium iodide should not be used, as otherwise lead iodide will separate out. In that case from 3 to 5 gms. more of sodium acetate are added and a few cubic centimeters of water. The mixture is shaken until the lead iodide has dissolved completely and not till then diluted to a volume of 25 c.c. The solution must remain perfectly clear and there should not be a trace of lead iodide precipitate.

This excellent method may also be used by the analysis of minium (red lead).

18. Determination of Ozone in Ozonized Oxygen.

$$1000 \text{ c.c. } \frac{N}{10} \text{ Na}_2\text{S}_2\text{O}_3 = \frac{\text{O}_3}{20} = \frac{48}{20} = 2.4 \text{ gms. O}_3.$$

(a) Schönbein's Method.

The most accurate method for estimating ozone consists in allowing the ozonized oxygen to act upon potassium iodide solution whereby free iodine is formed:

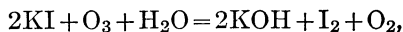

and the iodine may be titrated, after acidifying the solution with dilute sulphuric acid, by means of N/10 sodium thiosulphate.

It is not, however, immaterial whether the ozone reacts with a *neutral* or with an *acid* solution. In the latter case far too much iodine is liberated, although in the former case exactly the right amount is set free. Sir B. C. Brodie * called attention to this

† Phil. Trans., 162, 435-484 (1872).

fact in his classic researches on ozone. Brodie confirmed the results obtained of his titrations by weighing the amount of ozone used in the experiments. This work of Brodie's appears to have been forgotten,* for many other chemists have since that time attempted to work out an iodimetric method for estimating ozone, some using acid solutions of potassium and iodide and some neutral solutions to absorb the gas, although for a long time it occurred to no one else that the results could be checked by weighing out a definite amount of ozone for test experiments. In 1901, however, this was done in a very simple way by R. Ladenburg and R. Quasig,† who were without knowledge of Brodie's work. Their method consisted in weighing a glass bulb of known capacity which was provided with glass stop-cocks, filling it with oxygen and then weighing. The oxygen was then replaced by ozone, so that *the gain in weight multiplied by three represented the amount of ozone present.*

In order, now, to titrate the ozone, Ladenburg and Quasig expelled the gas from the bulb by distilled water, and conducted it slowly through a *neutral* solution of potassium iodide which was subsequently treated with an equivalent amount of sulphuric acid and the liberated iodine titrated with N sodium thio-sulphate.

The results of Ladenburg and Quasig have been carefully tested in the author's laboratory‡ and the method improved somewhat by absorbing the ozonized oxygen by potassium iodide solution in the glass bulb itself rather than expelling the gas from the bulb and passing it into the iodide solution.

The estimation of ozone by weighing is a much too round-about process to permit a practical application, particularly on account of the fact that the measurement and weighing of the gas must take place in a room at constant temperature, a condition which cannot in many cases be readily fulfilled. Consequently the volumetric titration of the gas is far more practical.

Procedure.—A glass bulk of about 300 to 400 c.c. capacity, of the form shown in Fig. 95, is procured and its volume accurately

* Luther and Inglis, *Z. phys. Chem.*, **48**, 208 (1903).

† *Ber.* **34**, 1184 (1901).

‡ Treadwell and Anneler, *Z. anorg. Chem.*, **48**, 86 (1905).

determined by weighing it empty and then filled with water, applying the correction for temperature as described on p. 517 et seq. The bulb is then connected with a gas delivery tube, making use of Babo flanged joints (Fig. 95, *c* and *d*) which are pressed together by means of a steel clamp, lined with cork. The delivery tube is connected with the supply of ozone and oxygen, with which the water in the bulb is replaced. During the filling of the bulb, but little of the ozone is absorbed by the water. When the

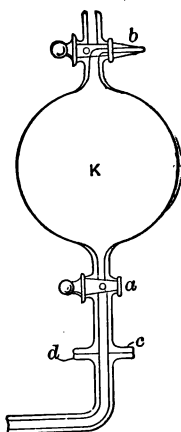

FIG. 95.



FIG. 96.

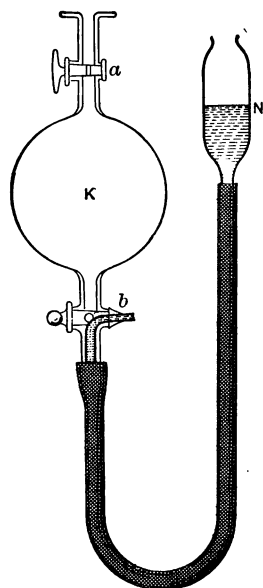

FIG. 97.

tube is filled, the lower stop-cock is closed first and the upper one a few seconds later. The bulb is then disconnected with the gas delivery tube, inverted, the upper-stop cock opened quickly for an instant in order to establish atmospheric pressure in the bulb, and then connected by means of rubber tubing with the gas reservoir *N* which is filled with double-normal potassium iodide solution (Fig. 97). The air imprisoned in the rubber tubing is allowed to escape through the three-way stop-cock *b* and after properly setting the cock, about 20 to 30 c.c. of the iodide solution

are introduced into the bulb. Finally the stop-cock *b* is closed and the rubber tubing disconnected. The contents of the bulb are vigorously shaken and allowed to stand for half an hour; at the end of this time the absorption of the ozone will be complete.

An Erlenmeyer flask is then placed under the stop-cock *b'*; this is opened and immediately afterwards the upper stop-cock also. The bulb is washed out first by introducing some potassium iodide solution through *a* and finally with pure water. The contents of the flask are then acidified with dilute sulphuric acid and the liberated iodine titrated with tenth-normal sodium thiosulphate.

The computation takes place as follows:

Contents of the bulb = V c.c.

Ozone found by titration = p gms.

Temperature = t , barometer reading = B , aqueous tension = w .

The volume of the bulb at 0° and 760 mm. pressure is

$$V_0 = \frac{V(B-w)273}{760(273+t)}.$$

When filled with oxygen this would weigh:

$$\frac{32 \cdot V_0}{22,391} \text{ gms.}$$

Therefore the weight of oxygen and ozone in the bulb is

$$\frac{32 \cdot V_0}{22,391} + \frac{p}{3},$$

and the per cent. of ozone in the mixture is

$$\frac{100 \cdot p}{\frac{32 \cdot V_0}{22,391} + \frac{p}{3}} = \frac{6,717,300 \cdot p}{96V_0 + 22,391} = \text{per cent. ozone.}$$

(b) *Method of Soret-Thenard.**

Ozone is absorbed quantitatively by means of sodium arsenite solution in accordance with the following equation:

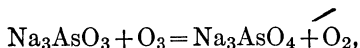

although A. Ladenburg † finds that the absorption takes place much more slowly than by means of potassium iodide. When, therefore, the ozone is passed through the arsenite solution, there is danger of getting too low results. If the absorption takes place in a glass bulb, however, the results are good.

Ozone is also absorbed by alkali bisulphite ‡ solutions and may be estimated in this way, by titrating the excess of bisulphite with iodine. Ladenburg, § however, has shown that the method is not as accurate as the potassium iodide one, so that it will not be considered further here.

19. Determination of Hydrogen Peroxide. Kingzett's Method.||

$$1000 \text{ c.c. } \frac{N}{10} \text{ Na}_2\text{S}_2\text{O}_3 \text{ solution} = \frac{\text{H}_2\text{O}_2}{20} = \frac{34.016}{20} = 1.7008 \text{ gms. H}_2\text{O}_2.$$

The hydrogen peroxide solution is diluted until its H_2O_2 content corresponds to about 0.6 per cent. by weight and of this solution 10 c.c. are used in the analysis.

Procedure.—About 2 gms. of potassium iodide are placed in an Erlenmeyer flask and dissolved in 200 c.c. of water, 30 c.c. of sulphuric acid (1:2) are added, and then, with constant stirring, 10 c.c. of the hydrogen peroxide solution are added from a pipette. After standing five minutes, the iodine liberated in accordance with the equation

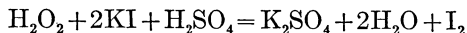

is titrated by means of tenth-normal thiosulphate solution.

* Compt. rend., 38, 445 (1854), 75, 174 (1872).

† Ber., 36, 115 (1903).

‡ Neutral alkali sulphite is not suitable here, because it is not oxidized quickly by pure oxygen alone.

§ *Loc. cit.*

|| J. Chem. Soc., 1880, 792.

Remark.—This method is rather better than that described on p. 627 because the titration can take place in the presence of glycerol, salicylic acid, etc., which are sometimes used as preservatives in commercial hydrogen peroxide preparations. These substances will render the results obtained by the permanganate titration less accurate.

20. Determination of Iron.

This method was first proposed by Carl Mohr* and is based upon the following reaction:



As the reaction is reversible, it is necessary to have an excess of hydriodic acid present in order that it may take place quantitatively in the direction from left to right.

Procedure.—The hydrochloric acid solution containing a weighed amount of the ferric salt is placed in a 300-c.c. glass-stoppered bottle, the greater part of the acid is neutralized by means of sodium hydroxide, and the air removed by means of a current of carbon dioxide. After this about 5 gms. of potassium iodide are added, the bottle closed, shaken, and allowed to stand in the cold for twenty minutes. The liberated iodine is then titrated with $\frac{N}{10}$ sodium thiosulphate solution. As soon as the blue color has disappeared † more carbon dioxide is conducted through the solution, the bottle is stoppered and allowed to stand for a few minutes to see whether the blue color will reappear. Should this be the case, more thiosulphate is added, the flask again stoppered and allowed to stand. If a blue color again appears, the solution contains too little potassium iodide, so that it is necessary to repeat the entire analysis, using 1–2 gms. more of it. With sufficient potassium iodide and only little free hydrochloric acid, the reaction is always complete at the end of twenty minutes. The results obtained are satisfactory.

* Ann. d. Chem. u. Pharm., 105, p. 53.

† Starch is added in all these titrations.

21. Determination of Copper. Method of Haën*-Low.†

$$1000 \text{ c.c. } \frac{N}{10} \text{ Na}_2\text{S}_2\text{O}_3 \text{ solution} = \frac{\text{Cu}}{10} = 6.357 \text{ gms. Cu.}$$

Principle.—If a solution of a cupric salt at a suitable concentration is treated with an excess of potassium iodide, all the copper is precipitated as cuprous iodide, and there is liberated one atom of iodine for each atom of copper present, $2\text{Cu}^{++} + 4\text{I}^- \rightarrow \text{Cu}_2\text{I}_2 + \text{I}_2$. The iodine is titrated with sodium thiosulphate solution. The method has been studied by Gooch and Heath ‡ who find that the quantity of potassium iodide used, the concentration of the solution, and the quantity of acid present are three factors which must be taken into consideration. In a volume of 50 c.c. an excess of from 0.6 to 1 g. of potassium iodide is sufficient to cause the complete precipitation of 0.0020 g. of copper but in a volume of 100 c.c. an excess of from 3 to 5 g. is desirable. In general, the more dilute the solution, the greater the quantity of potassium iodide required. A larger excess of potassium iodide does no harm.

A little free acid does no harm, but not more than 2 c.c. of concentrated mineral may be present in 50 c.c. of solution.

If an appreciable amount of arsenic is present, mineral acids must not be present on account of their tendency to bring about the reduction of the higher salts of arsenic and antimony when an excess of potassium iodide is used. Obviously the solution must not contain ferric iron or any other oxidizing agent.

Standardization of the Thiosulphate Solution.

In technical work it is customary to standardize the thiosulphate solution against pure copper. Weigh out 0.2 gm. of pure Cu into a 200-c.c. Erlenmeyer flask and dissolve in 5 c.c. of 8 N. HNO_3 . Dilute with 25 c.c. water and boil a few

* Ann. Chem. Pharm., 91, 237 (1854).

† Technical Methods of Ore Analysis.

‡ F. A. Gooch and F. H. Heath, Am. J. Sci., 4, 25, 67; F. H. Heath *ibid.*, 25, 153.

minutes to remove oxides of nitrogen. To remove the last of the nitrous oxides, add 5 c.c. of bromine water and boil until the excess bromine is expelled. Remove the flask from the flame and add strong ammonia until a slight excess is present. After boiling off the excess of ammonia, add 7 c.c. of strong acetic acid, which dissolves any copper oxide that has deposited. Cool to room temperature, add 3 gms. of potassium iodide and titrate the brown solution with sodium thiosulphate until nearly colorless, adding starch solution toward the last, and complete titration. In making the titration for the first time, one is bothered somewhat by the fact that the cuprous iodide is of a light-brown color. If t c.c. of the solution were used in titrating a gms. of copper then 1 c.c. of thiosulphate = $\frac{a}{t}$ gm. Cu.

Determination of Copper in Ores. Low's Method.

Principle.—The ore is dissolved in acid, the copper separated from iron, etc. by precipitating it upon metallic aluminium, the deposit dissolved in nitric acid and treated as in the standardization.

Procedure.—To 0.25–0.50 gms. of fine ore weighed into a 250-c.c. Erlenmeyer flask, add 6 c.c. of 16 N·HNO₃, and boil gently until nearly dry. Add 5 c.c. of 12 N·HCl and heat again. As soon as the incrustated matter has dissolved add 12 c.c. of H₂SO₄ (1 : 1) and heat until the acid fumes freely. Cool and add 25 c.c. of water. Then heat until any anhydrous ferric sulphate is dissolved, and filter to remove insoluble sulphates and silica. Wash the flask and filter-paper until the volume of the filtrate amounts to about 75 c.c., receiving it in a No. 2 beaker. Take a strip of aluminium, about 2.5 cm. wide and 14 cm. long, bend it into a triangle and place it in the beaker resting on its edge. Cover the beaker and boil gently for seven to ten minutes, which will be sufficient to precipitate all the copper, provided the solution does not much exceed 75 c.c. Avoid boiling to very small bulk. The aluminium should now appear clean, the copper being detached or loosely adhering. Remove from

the heat and wash down the cover and sides of the beaker with hydrogen sulphide water. This will prevent oxidation and will also serve to precipitate the last traces of copper. If the hydrogen sulphide shows that there was more than a very little copper remaining in solution, it is best to dilute the solution to 75 c.c. again and to boil a short time longer. This will coagulate the sulphide. Finally, decant through a filter and then, without delay, transfer the precipitate to the filter with the aid of a stream of hydrogen sulphide water from a wash bottle. Let the strip of aluminium remain in the beaker, but wash it as clean as possible with the hydrogen sulphide water. Wash the filter and precipitate at least six times with this hydrogen sulphide water, but take care not to let the filter remain empty for any length of time. Moist copper sulphide oxidizes very rapidly when in contact with the air with the formation of a little copper sulphate which will dissolve and pass through the filter only to precipitate again when it comes in contact with the filtrate containing hydrogen sulphide.

Now place the original clean flask under the funnel, perforate the filter and rinse the precipitate into the flask with hot water, using as little as possible. Lift the fold of the filter and rinse down any precipitate found beneath the fold. Using a small pipette, allow 5 c.c. of strong nitric acid to run over the aluminium in the beaker and pour it from the beaker through the filter into the flask, but do not wash the beaker or filter at this stage. Remove the flask and replace it with the beaker. Heat the contents of the flask to dissolve the copper and expel the red fumes, then again place the flask under the funnel. Now pour over the filter 5 c.c. or more of bromine water, using enough to impart a strong color to the solution in the flask. Next wash the beaker and aluminium, pouring the washings through the filter. Finally wash the filter six times with hot water. Boil till the solution is reduced to about 25 c.c., cool somewhat and add a slight excess of strong ammonia (about 7 c.c.). Boil off the excess of ammonia, add an excess of acetic acid, and boil a minute longer. Cool to room temperature, add 3 gm. of potassium iodide and titrate with sodium thiosulphate solution, adding starch toward the last.

22. Analysis of Arsenious Acid.

The titration is effected in the same way as in the standardization of the $\frac{N}{10}$ iodine solution, described on p. 650.

23. Determination of Antimony Trioxide Compounds.

$$1000 \text{ c.c. } \frac{N}{10} \text{ iodine solution} = \frac{\text{Sb}_2\text{O}_3}{40} = 7.21 \text{ g. Sb}_2\text{O}_3 = 6.01 \text{ g. Sb.}$$

The titration is carried out exactly as in the case of arsenious acid (cf. p. 650) except that tartaric acid, or Rochelle salt, must be added to the solution in order to prevent the precipitation of antimonous acid, or antimony oxychloride, as a result of hydrolysis.

Examples:

(a) Determination of Antimony in Tartar Emetic.

If an aqueous solution of tartar emetic be treated with iodine in the presence of starch, the first few drops of reagent will impart a permanent blue color to the solution. If, however, a little sodium bicarbonate is added to the solution, the trivalent antimony is oxidized quantitatively to the pentavalent condition.

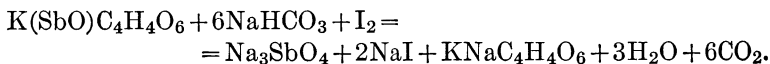

$$\begin{aligned} 1000 \text{ c.c. } \frac{N}{10} \text{ iodine solution} &= \frac{\text{K(SbO)C}_4\text{H}_4\text{O}_6 + \frac{1}{2}\text{H}_2\text{O}}{20} = \\ &= \frac{332.34}{20} = 16.617 \text{ gms.} \end{aligned}$$

8.309 gms. of tartar emetic are dissolved in water, the solution diluted to exactly 500 c.c. and well mixed. Of this solution, 20 c.c. are removed by a pipette, diluted to 100 c.c., treated with 20 c.c. of 2 per cent. sodium bicarbonate solution, and titrated with

tenth-normal iodine solution, using starch as an indicator. If t c.c. are used for the titration, the salt contains:

$$\frac{1.6617 \times 25 \times t}{8.309} = 5 \cdot t = \text{per cent. tartar emetic,}$$

or

$$= 1.809 \cdot t = \text{per cent. antimony.}$$

(b) *Determination of Antimony in Stibnite.*

Not over 0.5 gm. stibnite is dissolved in a *small* covered beaker by means of 10 c.c. concentrated hydrochloric acid (sp. gr. 1.2). The acid is allowed to act in the cold for about ten minutes, after which the contents of the covered beaker are heated gently on the water bath for ten or fifteen minutes. Three gms. of powdered tartaric acid are then added and the heating is continued for ten minutes longer, but care is taken not to allow the liquid to evaporate sufficiently to expose any part of the bottom of the beaker. When this precaution is taken, there is no volatilization of the antimony, and all of the hydrogen sulphide is expelled.

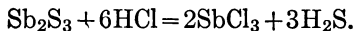

The solution is now removed from the water bath, allowed to cool to the room temperature, and very cautiously diluted with water, which is added at first drop by drop, until a volume of about 100 c.c. is obtained. If, in the meantime, a red coloration due to antimony sulphide appears during the dilution, the solution should be at once heated until it disappears, and the diluting then continued.

The diluted solution is nearly neutralized with ammonia, but is left slightly acid. The cold, slightly acid solution is poured into a 700 c.c. beaker containing 3 gms. of sodium bicarbonate dissolved in 200 c.c. of water, starch paste is added, and the solution titrated with iodine to the appearance of a permanent blue.

Remarks.—Antimony chloride is volatile with steam from its concentrated solutions, so that the solution should not be boiled until it has been diluted. The heating on the water-bath can be

carried out, however, without fear of losing antimony provided the acid is not allowed to evaporate to any extent. This heating serves to remove all the hydrogen sulphide which would otherwise precipitate the antimony as trisulphide upon diluting the solution. If insufficient tartaric acid is present, antimony oxychloride, SbOCl , precipitates and if the solution is titrated in this condition it is impossible to obtain a permanent end-point. Such a precipitate may be filtered off, dissolved in concentrated hydrochloric acid and the solution treated by itself as above described. The value of the iodine solution in terms of Sb is given in the previous process (a).

24. Determination of Antimony Pentoxide Compounds (A. Weller).*

By heating a pentavalent antimony compound with concentrated hydrochloric acid and potassium iodide in the Bunsen apparatus (Fig. 94, p. 662), the antimonious acid is reduced to antimonous acid with separation of iodine:

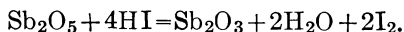

The iodine is distilled over into potassium iodide solution and titrated with $\frac{\text{N}}{10}$ $\text{Na}_2\text{S}_2\text{O}_3$ solution. The results are a little low.

25. Determination of Hydrogen Sulphide.

$$1000 \text{ c.c. } \frac{\text{N}}{10} \text{ Na}_2\text{S}_2\text{O}_3 \text{ solution} = \frac{\text{H}_2\text{S}}{20} = \frac{34.09}{20} = 1.704 \text{ gms. H}_2\text{S}.$$

If a solution of hydrogen sulphide is treated with iodine, it is oxidized with separation of sulphur:

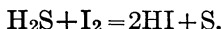

For the determination of the amount of the gas present in hydrogen sulphide water, a measured amount is transferred by

* *Annal.*, 213, 364.

means of a pipette to a known amount of $\frac{N}{10}$ iodine solution and the excess of the latter is titrated with thiosulphate solution.*

If the amount of hydrogen sulphide present is not very large, correct results are obtained without difficulty. With considerable hydrogen sulphide, on the other hand, the deposited sulphur is likely to enclose some of the iodine solution, as shown by its brown color; this iodine escapes the titration with thiosulphate. In such a case, the film of sulphur floating on the surface of the liquid is removed with a glass rod after the completion of the thiosulphate titration, transferred to a glass-stoppered cylinder, and shaken with 1-2 c.c. of carbon bisulphide. The latter dissolves the iodine with a violet color and the color is discharged by the addition of sodium thiosulphate solution.† In this way the total amount of the iodine that remains can be titrated.

Remark.—This method can be used to advantage for determining the sulphur present in soluble sulphides. The sulphides are decomposed as described on p. 350 by means of acid, and the hydrogen sulphide evolved is conducted into a definite amount of $\frac{N}{10}$ iodine solution. The excess of the latter is titrated as above with sodium thiosulphate solution.

Determination of Hydrogen Sulphide in Mineral Waters.

A measured amount of $\frac{N}{100}$ iodine solution and 2 gms. of potassium iodide are placed in a tall liter cylinder, 1000 c.c. of the water to be analyzed are added, and after thoroughly shaking, the excess of the iodine is titrated with $\frac{N}{100}$ thiosulphate. The standardiza-

* Correct results cannot be obtained by titrating directly with iodine, cf. O. Brunck, *Z. Anal. Chem.*, **45**, 541 (1906).

† The separation of the sulphur into a coherent film can be prevented by sufficiently diluting the solution with boiled water. O. Brunck (*Z. anal. Chem.*, **45**, 541) therefore, recommends using hundredth-normal iodine instead of tenth-normal solution, and this is certainly advisable in the case of small quantities of hydrogen sulphide as, for example, in a mineral water. On the other hand, when a relatively large volume of hydrogen sulphide is liberated from a sulphide by means of acid (see page 350) it is advisable to use tenth-normal iodine, as otherwise the volume of solution will be too large unless a very small weight of substance is used in the analysis.

tion of the iodine solution used is accomplished by measuring off 10 c.c. of the solution, adding 2 gms. of potassium iodide, diluting to 1 liter with boiled water, and titrating with $\frac{N}{100}$ thio-sulphate solution.

26. Analysis of Alkali Sulphides.

$$1000 \text{ c.c. } \frac{N}{10} \text{ iodine solution} = \frac{R_2S}{20} \text{ or } \frac{S}{20} = \frac{32.07}{20} = 1.604 \text{ gms. S.}$$

A measured volume of the alkali sulphide solution is allowed to run slowly, with constant stirring, into a very dilute solution of iodine which is acid with hydrochloric acid. The excess of iodine is titrated with sodium thiosulphate solution.

27. Analysis of a Mixture of Alkali Sulphide and Alkali Sulphydrate.

If a solution of alkali sulphide and alkali sulphydrate is treated with an acid solution of iodine, the following reactions take place:

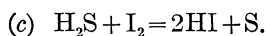
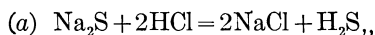

It is evident from these equations that in the case of the sulphide, the quantity of hydriodic acid formed by the oxidation of the hydrogen sulphide is equivalent to the quantity of hydrochloric acid required to decompose the sulphide; in this case, therefore, the acidity of the solution remains unchanged. In the case of the sulphydrate, however, which is the acid salt of hydrosulphuric acid, the quantity of hydriodic acid formed is equivalent to twice the quantity of hydrochloric acid required to decompose the sulphydrate. Thus the acidity of the solution is a measure of the quantity of sulphydrate present. Moreover, if t c.c. of tenth-normal alkali is required to titrate this acid then

2*t* c.c. of tenth-normal iodine must have been required to oxidize the hydrogen sulphide from the sulphhydrate.

Procedure.—A known volume of tenth-normal iodine together with a known volume of tenth-normal hydrochloric acid* is diluted in a beaker to a volume of about 400 c.c. and the solution containing the sulphide and sulphhydrate is added slowly from a burette, with constant stirring, until the solution becomes pale yellow. Starch indicator is added and the excess of iodine titrated with tenth-normal thiosulphate solution. Finally, the acid in the solution is titrated with tenth-normal sodium hydroxide solution.

Computation.—In the analysis, the volumes of standard solutions used were: *T* c.c. tenth-normal iodine; *t*₁ c.c. tenth-normal thiosulphate; *t*₂ c.c. tenth-normal hydrochloric acid; *t*₃ c.c. of tenth-normal sodium hydroxide: and *V* c.c. of the sulphide mixture.

Then (*T* - *t*₁) c.c. = total volume of iodine required, and (*t*₃ - *t*₂) c.c. = the volume of sodium hydroxide required to neutralize the acid formed by the reaction with the sulphhydrate. Then

$$(t_3 - t_2) \frac{\text{NaSH}}{10,000} = (t_3 - t_2) \times 0.005608 \text{ gm. NaSH,}$$

and

$$[(T - t_1) - 2(t_3 - t_2)] \frac{\text{Na}_2\text{S}}{20,000} = [(T - t_1) - 2(t_3 - t_2)] \times 0.003903 \text{ gms. Na}_2\text{S}$$

are present in *V* c.c. of solution.

* The quantity of hydrochloric acid present must be sufficient to decompose all the sulphide and sulphhydrate; an excess does no harm.

28. Analysis of a Mixture of Hydrogen Sulphide and Alkali Sulphydrate.

The analysis is carried out exactly as in the case just described and the computation is similar.

Let $T = \text{c.c. } \frac{N}{10}$ iodine, $t_1 = \text{c.c. } \frac{N}{10}$ thiosulphate, $t_2 = \text{c.c. } \frac{N}{10}$ acid, and $t_3 = \text{c.c. } \frac{N}{10}$ alkali. Then

$$[(T - t_1) - (t_3 - t_2)] \times 0.005608 \text{ gm. NaSH}$$

and

$$[t_1 + 2t_3 - (T + 2t_2)] \times 0.001701 \text{ gm. H}_2\text{S}.$$

Remark.—The last two methods of analysis are applicable only to solutions containing no other compounds decomposable by hydrochloric acid than sulphide and sulphydrate, and no other substance that will react with iodine. The analysis may be carried out without the addition of any hydrochloric acid. In this case the solution of sulphides is diluted to about 400 c.c., starch added, and the titration with iodine carried out directly. The hydriodic acid formed is titrated with caustic soda, using lacmoid* as indicator. The reactions are

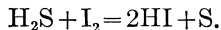
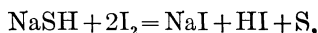

29. Determination of Thiosulphate in the Presence of Sulphide and Sulphydrate.

A measured volume of the solution is treated in a 200-c.c. graduated flask with an excess of freshly-precipitated cadmium carbonate. After shaking thoroughly, the liquid is diluted to the mark, filtered through a dry filter and 100 c.c. of the filtrate

* Methyl orange can be used, but it is not so easy to distinguish the end-point. Phenolphthalein works well but no better than the lacmoid. Care should be taken to titrate the acid against the alkali during the standardization at the same dilution as to be used in the analysis and an appreciable amount of carbonate should not be present.

titrated with iodine solution. By shaking with cadmium carbonate, the sulphide and sulphhydrate are removed and the thiosulphate remains in solution.

30. Determination of Sulphurous Acid.

$$1000 \text{ c.c. } \frac{N}{10} \text{ iodine solution} = \frac{\text{SO}_2}{20} = \frac{64.07}{20} = 3.203 \text{ gms. SO}_2.$$

The determination is based upon the following reaction:

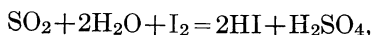

the sulphurous acid being oxidized to sulphuric acid. If starch is added to a solution of sulphurous acid, and a titrated iodine solution is run into it from a burette, the blue color will not be obtained until all of the sulphurous acid has been acted upon. Bunsen, however, in 1854 showed that this sensitive reaction, which was first used by Dupasquier, will only take place quantitatively according to the above equation when the solution does not contain more than 0.04 per cent. by weight of SO_2 . With greater concentrations uniform results are not obtained. This irregularity was ascribed to the reversibility of the reaction, so that it was suggested that the titration be performed in alkaline solution,* thus removing the hydriodic acid as fast as it is formed. But the results then obtained are still inaccurate.† Finkener,‡ on the other hand, states that correct values will be obtained if the sulphurous acid is allowed to run into the iodine solution.

J. Volhard § has confirmed the results of Finkener and shown that the anomalous results obtained on titrating sulphurous acid with iodine are not due to the reversibility of the reaction, for the direct addition of 20 per cent. sulphuric acid is without

* Addition of MgCO_3 or NaHCO_3 (Fordos and Gelis).

† E. Rupp, Ber., **35**, 3694 (1902), states that it is possible to obtain good results by the method of Fordos and Celis if the sulphurous acid is allowed to act for at least half an hour upon an excess of iodine in the presence of sodium bicarbonate. The solution is then titrated with sodium thiosulphate. According to E. Müller and O. Diefenthäler, however, this is theoretically incorrect, for the iodine tends to form a little hypoiodite: $\text{I}_2 + \text{H}_2\text{O} \rightleftharpoons \text{HI} + \text{HIO}$, and the latter reacts with sodium thiosulphate: $\text{Na}_2\text{S}_2\text{O}_3 + 4\text{HIO} + \text{H}_2\text{O} = \text{Na}_2\text{SO}_4 + \text{H}_2\text{SO}_4 + 4\text{HI}$.

‡ Finkener-Rose, Quantitative Analyse (1871), p. 937.

§ Ann. d. Chem. u. Pharm., **242**, 94.

influence. The incomplete oxidation of the sulphurous acid is caused by the fact that the hydriodic acid reduces a part of the sulphurous acid to free sulphur:*

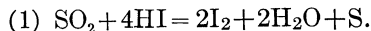

If sulphurous acid, whether dilute or concentrated, is allowed to run into a solution of iodine with constant stirring, there is complete oxidation of the SO_2 :

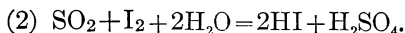

If, on the contrary, iodine solution is run into the solution of sulphurous acid, both reactions will take place:

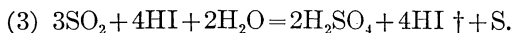

According to Raschig,† however, Volhard's explanation is also incorrect, for he finds that no separation of free sulphur takes place if the iodine is allowed to act upon sulphur dioxide in a *dilute* solution. Raschig believes that the error that results when iodine is added to the sulphurous acid solution is due to a loss of SO_2 by evaporation.

Correct results are always obtained if the sulphurous acid is added slowly, with constant stirring, to the iodine solution until the latter is decolorized.

In the analysis of sulphites, the sulphite solution is added from a burette to the solution of iodine and hydrochloric acid.

* If iodine solution is added slowly to a not too-dilute sulphurous acid solution, a distinct separation of sulphur is soon apparent.

† The HI acts as a catalyser according to Volhard.

‡ Z. Angew. Chem., 1904, 580.

31. Determination of Formaldehyde (Formalin). Method of G. Romijn.*

$$1000 \text{ c.c. N. iodine solution} = \frac{\text{HCHO}}{2} = \frac{30.02}{2} = 15.01 \text{ gms. formaldehyde.}$$

Principle.—Formaldehyde is quantitatively oxidized to formic acid by remaining in contact with iodine for a short time in alkaline solution:

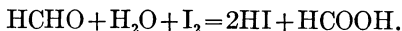

Procedure.—The aqueous solution of formaldehyde, known commercially as "formaline," contains about 40 per cent. of formaldehyde. For analysis, 10 c.c. of the formaldehyde solution are diluted to 400 c.c., and of this 1 per cent. solution, 5 c.c. (= 0.125 c.c. of the original solution) are taken for analysis. 40 c.c. of $\frac{\text{N}}{10}$ iodine solution are added, and immediately afterwards strong sodium hydroxide solution, drop by drop, until the color of the solution is a light yellow; it is then placed one side for ten minutes. The solution is then acidified with hydrochloric acid, and the unused iodine is titrated back with $\frac{\text{N}}{10}$ sodium thiosulphate solution.

$$1 \text{ c.c. } \frac{\text{N}}{10} \text{ iodine solution} = 0.001501 \text{ gm. formaldehyde.}$$

32. Determination of Hydroferricyanic Acid.†

$$1000 \text{ c.c. } \frac{\text{N}}{10} \text{ iodine solution} = \frac{\text{K}_3\text{Fe}(\text{CN})_6}{10} = \frac{329.2}{10} = 32.92 \text{ gms. K}_3\text{Fe}(\text{CN})_6.$$

Principle.—If a neutral solution of potassium ferricyanide is treated with an excess of potassium iodide, the ferricyanide ion is reduced to ferrocyanide ion with separation of free iodine:

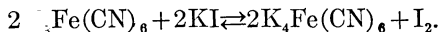

* Zeitschr. f. anal. Chem., 36 (1897), p. 19.

† Lenssen, Ann. Chem., 91, 240. Mohr., *Ibid.*, 105, 60.

Lenssen titrates the liberated iodine with sodium thiosulphate, but the results are not concordant, because the reaction is a reversible one. The reaction is quantitative, however, as Mohr first showed, if the ferrocyanide is removed from the solution as fast as it is formed. This is accomplished, according to Mohr, by adding an excess of zinc sulphate, free from iron, to the solution. According to the experiments of E. Müller and O. Diefenthäler,* the titration should take place in a solution which is as nearly neutral as possible, but not in one made alkaline by the addition of sodium bicarbonate (see p. 692).

Müller and Diefenthäler's Procedure.—About 0.7 gm. of the ferrocyanide is weighed into a glass-stoppered flask, dissolved in about 50 c.c. water, and treated with 3 gms. potassium iodide and 1.5 gms. of zinc sulphate free from iron. If an acid solution of ferricyanide is to be analyzed, it is carefully neutralized with caustic soda until barely alkaline and then just acidified with a drop of sulphuric acid. Alkaline solutions must always be neutralized with acid.

33. Determination of Phenol. Method of W. Koppeschaar.†

$$1000 \text{ c.c. } \frac{N}{10} \text{ Na}_2\text{S}_2\text{O}_3 = \frac{\text{C}_6\text{H}_5\text{OH}}{60} = \frac{94.05}{60} = 1.567 \text{ gms. C}_6\text{H}_5\text{OH.}$$

Principle.—If an aqueous solution of phenol is treated with an excess of bromine, the phenol is converted quantitatively into tribromophenol:



The tribromophenol is a pale yellow, crystalline substance which is quite insoluble in water (43,700 parts of water dissolve 1 part of tribromophenol). If, after the reaction has taken place, potassium iodide is added to the solution, iodine is liberated corresponding to the excess of bromine, and by titrating this

* Z. anorg. Chem., 1910, 418.

† Z. anal. Chem., 15, 233 (1876).

iodine with sodium thiosulphate solution, it is easy to find how much bromine reacted with the phenol.

Requirements.—A tenth-normal solution of bromine and a tenth-normal solution of sodium thiosulphate.

On account of the volatility of free bromine, Koppescharr uses a solution of potassium bromate and bromide which, upon being acidified, gives a known amount of bromine in accordance with the equation:

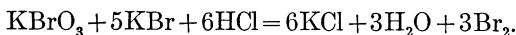

Thus, to obtain a tenth-normal solution of bromine which will keep indefinitely, *exactly* 2.784 gms. of pure potassium bromate (dried at 100°) and about 10 gms. of potassium bromide are dissolved in water and the solution diluted to one liter. An excess of bromide does no harm:

$$\frac{\text{KBrO}_3}{60} = \frac{167.02}{60} = 2.784,$$

$$\frac{5\text{KBr}}{60} = \frac{5 \times 119.02}{60} = 9.918.$$

Procedure.—About 0.5 gm. of phenol is weighed out in a weighing beaker, dissolved in a little water, the solution rinsed into a liter flask and well shaken. Of this solution, 100 c.c. are withdrawn in a pipette, transferred to a second liter flask, diluted with water up to the mark, mixed and 170 c.c. this solution transferred to a stoppered bottle of about 250-c.c. capacity, treated with 50 c.c. of the bromate solution, shaken, acidified with 5 c.c. concentrated hydrochloric acid, shaken again, and allowed to stand fifteen minutes. At the end of this time, 2 gms. of potassium iodide are added and the liberated iodine, corresponding to the excess of bromine, is titrated with tenth-normal thiosulphate solution, using starch as indicator. Then if t c.c. of the last solution are used and the weight of phenol was a gms.:

$$\frac{(50-t) \times 0.1567}{a} = \% \text{ phenol.}$$

Remark.—Before making an analysis, a blank experiment should always be made with the bromate solution to make sure that its strength corresponds to the theoretical value.

This method is suitable for the analysis of pure preparations of phenol (carbolic acid) but not for crude phenol, creosote oil, etc.*

B. REDUCTION METHODS.

1. Determination of Ferric Iron (Fresenius).†

In the case of all methods previously discussed, it was necessary to reduce the iron to the ferrous condition before it could be determined volumetrically. In the following method, first suggested by Penny and Wallace,‡ but improved by Fresenius, the iron in the *ferric* condition may be determined with accuracy and rapidity.

The hydrochloric acid solution containing ferric chloride is titrated hot with stannous chloride solution until the former becomes colorless. By this means the ferric salt will be reduced to ferrous salt:

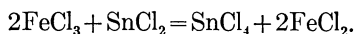

Inasmuch as it is not very easy to determine the end-point with accuracy, because the last part of the iron is reduced very slowly, it is customary to run over the end-point and to titrate the excess of the stannous chloride with iodine solution.

Solutions Required. 1. *A Ferric Chloride Solution Containing a Known Amount of Iron.*—It is prepared by dissolving exactly 10.03 gms. of bright iron wire in hydrochloric acid within a long-necked flask held in an inclined position; the iron is oxidized with potassium chlorate and the excess of chlorine is completely

* J. Toth, Z. anal. Chem., 25, 160 (1886).

† Z. anal. Chem., 1, p. 26.

‡ Dingl. polyt. J., 149, 440.

expelled by boiling. The solution of ferric chloride is washed into a liter flask and diluted up to the mark with water; 50 c.c. of this solution contain 0.5 gm. of pure iron.*

2. *A Stannous Chloride Solution.*—25 gms. of tin-foil are heated for two hours on the water-bath with 50 c.c. of hydrochloric acid of specific gravity 1.134 and a few drops of chloroplatinic acid in a porcelain dish which is covered with a watch-glass. After this, 150 c.c. of hydrochloric acid and an equal volume of water are added, the solution filtered and diluted up to 1 liter. As stannous chloride is oxidized by contact with the air, it is placed in a flask which on one side is connected with the burette as shown in Fig. 87, p. 556 and on the other side with a Kipp carbon dioxide generator.

3. *An Iodine Solution Approximately Tenth-normal.*

Procedure.—(a) Standardization of the Solutions.

First of all, the stannous chloride and iodine solutions are titrated against one another. About 2 c.c. of the former are measured from the burette, diluted to about 60 c.c., a little starch solution added, and the mixture titrated with iodine until a blue color is obtained.

Next, 50 c.c. of the acid ferric chloride solution containing a known amount of iron are titrated against the stannous chloride solution.

(b) *Determination of Iron in Hematite.* 5 gms. of the finely-divided ore are ignited in order to destroy any organic matter which may be present, then placed in a long-necked flask and boiled with concentrated hydrochloric acid and a little potassium chlorate until the iron oxide is all dissolved, leaving behind nothing but a white sandy residue. After this 20 c.c. more of hydrochloric acid are added and the boiling is continued while a current of air is passed through the solution, until all the excess of chlorine is completely removed and the escaping vapors will no longer set free iodine when passed into a potassium iodide solution. The solution thus obtained is diluted to exactly 500 c.c. and 50 c.c. of it are taken for the analysis.

* The assumption being made that the iron wire contained 99.7 per cent pure iron.

*Example.***1. Standardization of the reagents:**

2 c.c. of stannous chloride solution require
 7.2 c.c. of iodine solution. 1 c.c. iodine solution = 0.278 c.c. SnCl₂
 50 c.c. ferric chloride solution (= 0.5 gm. iron)
 require for decolorization 30.34 c.c. SnCl₂
 and for the titration of the excess 0.51 c.c. of
 iodine solution = 0.51 × 0.28 0.14 c.c. SnCl₂
 Consequently, 50 c.c. ferric chloride solution
 = 0.5 gm. iron = 30.20 c.c. SnCl₂
 and 1 c.c. SnCl₂ = $\frac{0.5}{30.20}$ = 0.01656 gm. Fe.

2. Titration of the solution to be analyzed:

50 c.c. (= 0.5 gm. of iron ore) require 18.96 c.c. SnCl₂
 and for the titration of the excess, 0.64 c.c. of
 iodine = 0.64 × 0.28 = 0.18 c.c. SnCl₂
 so that 0.5 gm. of ore corresponds to 18.78 c.c. SnCl₂

and contain, therefore, 18.78 × 0.01656 = 0.3110 gm. Fe,
 and in per cent.:

$$0.5:0.3110=100:x$$

$$x=62.20 \text{ per cent. Fe.}$$

2. Determination of Ferric Iron by Means of Titanous Chloride (Knecht and Hibbert).*

$$1000 \text{ c.c. } \frac{N}{10} \text{ TiCl}_3 \text{ solution} = \frac{O}{20} = 0.8 \text{ g. oxygen} = \frac{Fe}{10} = 5.585 \text{ g. Fe.}$$

Principle.—If an acid solution of a ferric salt is treated with titanous chloride, the iron is immediately reduced in the cold to the ferrous condition:

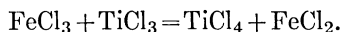

Preparation of Titanous Chloride Solution.—A concentrated solution of titanous chloride, prepared by the electrolysis of TiCl₄, can now be obtained on the market. Such a solution is treated

*Ber. 36, 1551 (1903).

with an equal volume of concentrated hydrochloric acid, boiled,* and then diluted with ten times as much boiled water.

The solution is maintained in contact with an atmosphere of hydrogen, or carbon dioxide, and kept in a bottle such as is shown in Fig. 87, p. 556 which is connected with a burette, and in this case with a Kipp hydrogen, or carbon dioxide, generator instead of the soda lime tube.

Standardization of the Titanous Chloride Solution.—A ferric chloride solution known of strength is prepared as described on p. 697, and of this solution 50 c.c. are measured out into a beaker, and the titanium trichloride is slowly added with constant stirring, while a current of carbon dioxide is constantly being passed into the beaker. After the solution is nearly decolorized, a drop of potassium sulphocyanate solution is introduced, and the addition of titanous chloride is continued to the disappearance of the red color.

The analysis proper is carried out in exactly the same manner.

3. Determination of Ferrous and Ferric Iron by the Titanium Method.

The ferrous iron is first titrated by means of permanganate in the presence of manganous sulphate (cf. p. 607) and then the total iron is determined as above with titanous chloride.

The method can be carried out very rapidly and the results are accurate.

4. Determination of Hydrogen Peroxide.†

If titanous chloride is run into an acid solution of hydrogen peroxide, the latter is colored first yellow, then a deep orange, and as soon as the maximum depth of color is produced, it begins to fade upon the further addition of titanous chloride until finally the solution becomes colorless, which is taken as the end-point.

The reaction takes place in two stages:

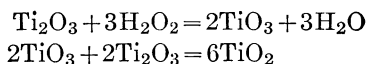

or combining the two equations:



* The boiling serves to expel any hydrogen sulphide that is present.

† Knecht and Hibbert, *Ber.*, **38**, 3324 (1905).

On account of the fact that the value of the titanous chloride solution is not very permanent, it is standardized against ferric chloride before each series of experiments.

If t c.c. of titanous chloride solution of which 1 c.c. = α gms. Fe were required for the reduction of 1 c.c. of hydrogen peroxide, then the amount of the latter is

$$2\text{Fe}:\text{H}_2\text{O}_2 = \alpha t : x$$

$$x = \frac{34.02 \times \alpha t}{111.7} \text{ gms. H}_2\text{O}_2$$

and in per cent.

$$30.46\alpha t = \text{per cent. H}_2\text{O}.$$

If it is desired to express the per cent. in per cent. by volume of active oxygen (cf. p. 628) the following proportion holds:

$$10023 \cdot \alpha t = \text{per cent. oxygen by volume.}$$

According to Knecht and Hibbert,* persulphuric acid may likewise be estimated by titration with titanous chloride. The solution of the persulphate is treated with titanous chloride solution and the excess of the latter is titrated with ferric chloride in an atmosphere of carbon dioxide.

5. Determination of Hypochlorous Acid by Means of Arsenious Acid.

$$1000 \text{ c.c. } \frac{\text{N}}{10} \text{ As}_2\text{O}_3 = 3.546 \text{ gms. chlorine.}$$

On adding arsenious acid to a solution of a hypochlorite, the former is oxidized to arsenic acid, while the latter is reduced to chloride:

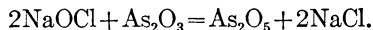

The end-point is reached when a drop of the solution added to a piece of iodo-starch paper will cause no blue coloration.

Alkali hypochlorites and chloride of lime may be analyzed by this method and the results obtained are more reliable than in the case of those obtained by the iodimetric method described on p. 669, for the presence of chlorate has no effect in this case.

*Knecht and Hibbert, Ber. 38, 3324 (1905).

III. PRECIPITATION ANALYSES.

1. Determination of Silver. Method of Gay-Lüssac.

This exceedingly accurate determination, which is extensively used for testing silver alloys, depends upon the precipitation of silver chloride from nitric acid solution. Common salt is used as the precipitant.

Solutions Required. 1. *Sodium Chloride Solution of Known Concentration.*—For convenience, it is customary to make the solution of such a strength that 1000 c.c. correspond to exactly 5 gms. of silver. It is more practical, however, to use a somewhat weaker solution, consequently 2.700 gms. of chemically pure salt are dissolved in distilled water and diluted to 1 liter.

2. *Decimal Solution of Sodium Chloride.*—100 c.c. of the above solution are diluted with distilled water to 1 liter.

In laboratories where silver determinations are frequently made, the above solutions are made up in much larger quantities and kept in bottles similar to the one shown in Fig. 87, p. 556. The stronger solution is connected with a 100-c.c. pipette and the decimal solution with a burette.

Standardization of the Sodium Chloride Solution.—Exactly 0.5 gm. of chemically pure silver is weighed into a 200-c.c. flask provided with a well-ground glass stopper, and dissolved in 10 c.c. of nitric acid of specific gravity 1.2, free from chlorine. The solution is hastened by heating on a sand-bath. When the silver has dissolved, the solution is heated to boiling in order to expel the nitrous acid formed. The brown vapors collecting in the flask are removed by blowing in air. As soon as no more of these are formed, the flask is removed from the sand-bath, and allowed to cool. To the silver solution exactly 100 c.c. of the stronger salt solution are added, the flask stoppered, and vigorously shaken until the precipitated silver chloride collects together, and the supernatant liquid appears clear.

As the salt solution was made up a little weak, the precipitation of the silver is not quite complete and consequently more sodium chloride must be added. For this purpose half a cubic centimeter of the decimal salt solution is added from the burette, so that the solution runs down the sides of the flask upon the surface of the liquid, causing a distinct cloud of silver chloride to be formed. The liquid is shaken, allowed to settle, again treated with half a cubic centimeter of the decimal salt solution, and the process repeated until finally the addition of the salt solution fails to produce any further turbidity; the last half cubic centimeter is not used in the calculation.

Example.—0.5 gm. of chemically pure silver ($\frac{1000}{10000}$ fine) required 100 c.c. of the standard salt solution + 1 c.c. of the decimal solution, i.e., 100.1 c.c. of the salt solution correspond to 1000 silver; * this is the value of the salt solution.

Silver Determination.—In order to obtain absolutely accurate results it is necessary to employ the same amount of silver for the analysis as was used in the standardization of the solution, consequently the approximate amount of silver present in the alloy must be determined. This can be accomplished by cupellation, or volumetrically by the method of Volhard, described further on.

Example.—It was found by cupellation that an alloy contained about $\frac{8000}{10000}$ fine silver; for the titration an amount must be taken which will contain 0.5 gm. of silver; we have then

$$\begin{aligned} 1:0.8 &= x:0.5 \\ x &= 0.625 \text{ gm.} \end{aligned}$$

We weigh out, therefore, 0.625 gm. (= 1250 †) of the alloy and proceed exactly as in the standardization.

1250 of alloy require for the precipitation of the silver 100 c.c. of the standard salt solution + 3 c.c. of the decimal solution, i.e., 1250 parts of the alloy require 100.3 c.c. of the standard salt

* For convenience in calculation, 0.5 gm. of pure silver is designated by 1000, 0.25 gm. by 500, and 0.1 gm. by 250, etc.

† If 0.5 gm. = 1000, then 0.5:1000 = 0.625:x; x = 1250.

solution. Since 100.1 c.c. of this salt solution correspond to 1000 parts of pure silver, we have

$$100.1 : 1000 = 100.3 : x;$$

$$x = \frac{1000 \times 100.3}{100.1} = 1002 \text{ parts silver in 1250 parts of alloy};$$

so that in 1000 parts of the alloy there will be

$$1250 : 1002 = 1000 : x$$

$$x = 801.6 \text{ parts fine of silver.}$$

This procedure is designated as the French method in contrast to the German or Dutch method. In the latter case, 0.5 gm. of the alloy (=1000) is weighed out and the same amount of silver is added which the alloy lacks in fineness. In this way one more weighing is necessary, but the calculation is somewhat simpler.

Example.—By cupellation an alloy is found to contain $\frac{800}{1000}$ silver. In order to make the silver equal 1000, 200 parts of fine silver must be added. For the analysis, therefore, 0.5 gm. of the alloy and 0.1 gm. of pure silver (=200) are taken, dissolved in nitric acid, and titrated with sodium chloride.

For the titration of the alloy, 100.25 c.c. of the stronger salt solution were required, or of the decimal solution, 1002.5 c.c. and for the titration of 1000 fine silver (0.5 gm.) 1001.0 c.c.

$$\text{Difference} \dots\dots\dots = 1.5 \text{ c.c.}$$

As 1 c.c. of the decimal solution corresponds to $\frac{1}{1000}$ * silver, it is evident that 1.5 c.c. are equivalent to $\frac{1.5}{1000}$ silver. If this amount is added to the assumed silver contents (in this case 800), the true fineness of the silver alloy will be obtained; i.e. 801.5 parts fine silver.

* 100.1 c.c. of the stronger salt solution = 5 gms. $\frac{1000}{1000}$ silver, then 1001 c.c. of the decimal solution correspond to the same amount, and 1 c.c. = $\frac{1}{1000}$ silver.

2. Determination of Silver (Volhard).

$$1000 \text{ c.c. } \frac{N}{10} \text{ KCNS} = \frac{\text{Ag}}{10} = \frac{107.88}{10} = 10.788 \text{ gms. Ag.}$$

If to a silver solution containing iron ammonium alum, free from chloride but containing enough nitric acid to discharge the brown color of the iron salt, a solution of alkali sulphocyanate is added, white insoluble silver sulphocyanate is precipitated:

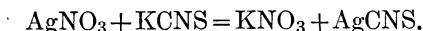

When all the silver is precipitated, the next drop of the sulphocyanate solution will cause a permanent red coloration due to the formation of ferric sulphocyanate.

Requirements. 1. *Tenth-normal Silver Solution.*—10.788 gms. of chemically pure silver are dissolved in nitric acid free from chloride, boiled until the nitrous acid* is all removed, and diluted with distilled water to a volume of 1 liter.

2. *Tenth-normal Potassium (or Ammonium) Sulphocyanate Solution.*—As both of these salts are hygroscopic and cannot be dried without decomposition, an exactly tenth-normal solution cannot be prepared by weighing out the solid salt. Approximately, the right amount (about 10 gms. KCNS or 9 gms. NH_4CNS) is dissolved in a liter of water and the solution standardized against the silver solution.

3. *Iron-ammonium Alum Solution.*—A cold, saturated solution of ferric alum to which enough nitric acid is added to cause the disappearance of the brown color. Of this indicator the same amount is used for all titrations, about 1 or 2 c.c. for 100 c.c. of the silver solution.

For the standardization of the sulphocyanate solution, 20 c.c. of the silver solution are placed in a beaker, diluted with about 50 c.c. of water, and 1 c.c. of the indicator added. The sulphocyanate solution is then added from a burette, with constant stirring, until a permanent red color is obtained.

* Nitrous acid reacts with sulphocyanic acid, forming a red compound which may easily be mistaken for ferric sulphocyanate.

Determination of Silver in Silver Alloys.

About 0.5 gm. of the brightly polished metal is dissolved in nitric acid of specific gravity 1.2, the solution boiled to expel the nitrous acid, diluted with cold water to about 50 c.c., and after the addition of 1 c.c. of the ferric alum solution it is titrated with the sulphocyanate solution as in the standardization of the latter. The presence of metals whose salts are colorless does not influence the accuracy of this determination, except that mercury must be absent because its sulphocyanates are insoluble. Nickel and cobalt must not be present to any extent, because their salts are colored, and not more than 60 per cent. of copper in an alloy is permissible. In case more copper is present the following procedure must be used: The silver is precipitated by means of an excess of alkali sulphocyanate, washed completely with water, the funnel placed over an Erlenmeyer flask, the apex of the filter broken, its contents washed into a flask by means of concentrated nitric acid (sp. gr. 1.4), and the liquid heated to gentle boiling for three-quarters of an hour. As the sulphuric acid formed will have some influence upon the subsequent titration, the solution is diluted with water to about 100 c.c., and a concentrated barium nitrate solution is added drop by drop until the sulphuric acid is all precipitated, after which the silver is titrated with sulphocyanate solution without filtering off the barium sulphate.

Remark.—From experiments in his laboratory carried out by Osann, the author concludes that the Volhard method is less reliable than that of Gay-Lussac. Apparently the experiments of Hoitsema* indicate that the precipitate adsorbs potassium thiocyanate. If, however, the solution is standardized against very nearly the same quantity of silver (or the equivalent amount of silver nitrate) as is taken for analysis, this error is compensated and the results are very exact.—(TRANSLATOR.)

* Z. angew. Chem., 1904, 647.

3. Determination of Chlorine.

(a) Volhard's Method.

$$1000 \text{ c.c. } \frac{N}{10} \text{ AgNO}_3 \text{ solution} = \frac{\text{Cl}}{10} = 3.546 \text{ gms. chlorine.}$$

According to Volhard's original directions, the chloride solution was treated with tenth-normal silver nitrate solution and then, without filtering off the precipitate, 5 c.c. of the ferric-ammonium alum solution were added and the excess of silver titrated with tenth-normal potassium or ammonium thiocyanate (see p. 705).

The results are satisfactory with large quantities of chloride, but in the titration of small quantities of chloride too high results are obtained, as was first shown by G. Drechsel* and later confirmed by M. A. Rosanoff and A. E. Hill.† Drechsel showed that it was impossible to get the true end-point of the reaction, as the red coloration gradually disappeared on stirring, remaining permanent only after a considerable excess of thiocyanate had been added. The reason for this is that silver chloride is more soluble than silver thiocyanate. Thus the precipitate gradually reacts with the red ferric thiocyanate, as follows:

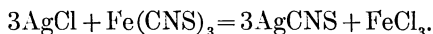

To avoid this error Drechsel proceeds as follows:

The chloride solution is placed in a 200-c.c. graduated flask, an excess of 0.1N AgNO_3 solution added, the solution acidified with nitric acid, and the stoppered flask shaken until the precipitate coagulates enough to give a clear supernatant liquid. The solution is then diluted up to the mark, thoroughly mixed and filtered through a dry filter, rejecting the first 10 c.c. of filtrate. Of the filtrate, 50 or 100 c.c. are taken, the ferric alum indicator added, and the excess of silver titrated with 0.1N thiocyanate solution. The results thus obtained are excellent.

* Z. anal. Chem., 16, 351 (1877).

† J. Am. Chem., Soc. 29, 269.

Remark.—V. Rothmund and A. Burgstaller* find that it is possible to obtain correct results without filtering off the silver chloride precipitate. They heat the solution after the addition of the excess of silver nitrate, until the precipitate coagulates thoroughly, in which form it reacts less readily with a soluble thiocyanate. After cooling, the ferric alum indicator is added and the titration finished. Rothmund and Burgstaller also find that the coagulation of the silver chloride precipitate by ether † suffices to make the filtration unnecessary. The chloride solution is placed in a flask with tightly fitting glass stopper, 5 c.c. of ether added, and an excess of silver nitrate solution. After shaking a few minutes, the supernatant solution becomes clear and the titration can be finished with accuracy.

(b) *Fr. Mohr's Method.*

If the neutral solution of an alkaline or alkaline-earth chloride containing a few drops of potassium chromate solution* is treated with silver nitrate solution, added from a burette, a red precipitate of silver chromate is formed which, on stirring, disappears on account of its being decomposed by the alkali chloride to silver chloride and alkali chromate:

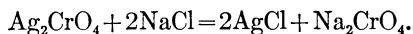

When all of the chlorine is changed to insoluble silver chloride, the next drop of the silver solution will impart a permanent reddish color to the liquid. For small amounts of chloride in concentrated solutions this method gives very sharp results. If, however, the volume of the solution is too large, the results are not very accurate. In all cases, a blank experiment must be made to see how much of the silver solution is necessary to produce the red shade used in the titration when no chloride is present, and this amount must be deducted from that used in the analysis.

* Z. anorg. Chem., **63**, 330 (1909).

† Cf. E. Alefeld, Z. anal. Chem., **48**, 79 (1909).

‡ Lunge uses sodium arseniate as indicator, and this is to be recommended on account of the change from colorless to brown being very easy to detect.

Remark.—If it is desired to titrate free hydrochloric acid, the solution is first neutralized with ammonia. In the case of colorless chlorides having an acid reaction (AlCl_3) the solution is treated with an excess of neutral sodium acetate solution and then titrated. With colored metal chlorides, the metal is precipitated with caustic potash or sodium carbonate, filtered, washed, the filtrate acidified faintly with acetic acid, and the titration then made.

4. Determination of Bromine.

(a) Volhard's Method.

$$1000 \text{ c.c. } \frac{N}{10} \text{ AgNO}_3 \text{ solution} = \frac{\text{Br}}{10} = 7.992 \text{ gms. bromine.}$$

The solution of the bromide is treated with an excess of 0.1N silver solution and the solution titrated with ammonium thiocyanate, using ferric alum as indicator. From the required volume of silver nitrate, the quantity of bromine is computed.

Remark.—It is not necessary to filter off the silver bromide, because, unlike the chloride, silver bromide is more insoluble than is silver thiocyanate.

(b) Fr. Mohr's Method.

The procedure is the same as in the case of the chloride determination.

5. Determination of Iodine.

Volhard's Method.

$$1000 \text{ c.c. } \frac{N}{10} \text{ AgNO}_3 \text{ solution} = \frac{\text{I}}{10} = 12.692 \text{ gms. iodine.}$$

If silver iodide is produced in a solution of an iodide by the addition of silver nitrate, the precipitate will usually enclose a

measurable amount of either the soluble iodide or the silver nitrate, so that the analysis cannot be accomplished in the same way as in the analysis of chlorides and bromides.

The solution is placed in a glass-stoppered flask, diluted to 200–300 c.c., and the silver solution is added with vigorous shaking until the yellow precipitate collects together and the supernatant liquid appears colorless. As long as the solution appears milky the precipitation is not complete. A little more silver nitrate is finally added and the solution again shaken in order to precipitate any iodide in the pores of the silver iodide. Then ferric alum solution* is added, the excess of silver titrated with potassium sulphocyanate, and the iodine calculated from the amount of silver used. In this way Volhard obtained exact results.

6. Determination of Cyanogen.

(a) *Volhard's Method.*

$$1000 \text{ c.c. } \frac{N}{10} \text{ AgNO}_3 \text{ solution} = \frac{\text{KCN}}{10} = 6.511 \text{ gms. KCN.}$$

If an excess of silver nitrate is added to a solution containing potassium cyanide and we attempt to titrate the excess of the former by means of potassium sulphocyanate, using a ferric salt as an indicator, there will be no distinct end-point, because the silver cyanide reacts with the ferric sulphocyanate:

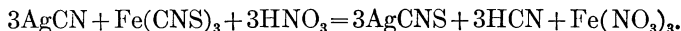

The red color obtained in the titration will disappear on stirring. If, however, the neutral cyanide solution is treated with an excess of the silver solution, then slightly acidified with nitric acid, diluted up to a definite volume in a measuring-flask and filtered through a dry filter, the excess of silver can then be titrated in an aliquot part of the filtrate.

* The ferric solution must not be added before the iodine is completely precipitated, because in acid solution it oxidizes the hydriodic acid with separation of iodine. Silver iodide, however, is without action on ferric salts.

*(b) Liebig's Method.**

$$1000 \text{ c.c. } \frac{\text{N}}{10} \text{AgNO}_3 \text{ solution} = \frac{\text{KCN}}{5} = 13.022 \text{ gms. KCN.}$$

On adding silver nitrate solution drop by drop to a neutral or alkaline alkali cyanide, a white precipitate is formed when the two liquids first come in contact with one another, but on stirring it redissolves owing to the formation of potassium silver cyanide:

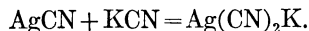

As soon as all of the cyanogen is transformed into potassium silver cyanide, the next drop of the silver solution will produce a permanent turbidity:

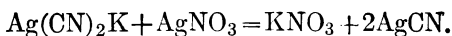

The total reaction is, therefore,

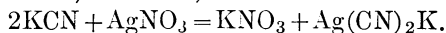

1 Ag corresponds to 2 CN and the end-point of the reaction is shown by the formation of a permanent precipitate.

The alkali cyanide solution is placed in a beaker, a little potassium hydroxide is added, and the solution diluted to a volume of about 100 c.c. The beaker is placed on a piece of black glazed paper and titrated with constant stirring until the turbidity is obtained.

For the analysis of free hydrocyanic acid, the solution is saturated with potassium hydroxide and treated as above.

The addition of 5 c.c. of 2 per cent. potassium iodide solution slightly increases the sharpness of the end-point in the above analysis. The precipitate then consists of silver iodide of which one molecule will dissolve in two molecules of potassium cyanide, just as silver nitrate does.

Determination of Chlorine and Cyanogen in the Presence of One Another.

First, the cyanogen is determined by the method of Liebig, and then enough silver solution is added to convert all of the cyanogen and chlorine into their silver salts. The solution is acidified with nitric acid, diluted with water to a definite volume, filtered

* Ann. d. Chem. und Pharm., 77, p. 102.

through a dry filter, and an aliquot part of the filtrate used for the titration of the excess of silver by means of potassium sulphocyanate, according to Volhard. The calculation of the cyanogen and chlorine is illustrated by the following example:

10 c.c. of the solution required for the production of a permanent turbidity t c.c. $\frac{N}{10}$ silver solution. Then an excess of $\frac{N}{10}$ silver solution is added (T c.c. being the total amount used), the solution acidified with nitric acid, diluted to exactly 200 c.c.,* filtered through a dry filter, and the excess of the silver titrated in 100 c.c. of the filtrate; this required t_1 c.c. $\frac{N}{10}$ potassium sulphocyanate solution. Consequently the amount of cyanogen present is $t \times 0.005202$ gm., and the chlorine present amounts to $[T - 2(t + t_1)]0.003546$ gm.

7. Determination of Sulphocyanic Acid. Volhard's Method.

$$1000 \text{ c.c. } \frac{N}{10} \text{ AgNO}_3 \text{ solution} = \frac{\text{HCNS}}{10} = 5.909 \text{ gms. HCNS.}$$

This is the reverse of the silver determination (p. 705). An excess of $\frac{N}{10}$ silver solution is added to the solution containing the sulphocyanate, and the excess of silver is titrated with potassium sulphocyanate solution, using ferric alum as an indicator.

Determination of Sulphocyanic and Hydrocyanic Acids in the Presence of One Another.

A little potassium hydroxide is added to the solution, and after diluting to about 100 c.c., the cyanogen is titrated by the method of Liebig (p. 711). Then, after adding an excess of silver solution, nitric acid is added to acid reaction, and the excess of the silver is titrated with potassium sulphocyanate in an aliquot part of the filtrate.

* The operation is performed in a measuring-flask. After the addition of the acid, the flask is filled up to the mark with water, thoroughly mixed, and then filtered.

Determination of Hydrochloric, Hydrocyanic, and Sulphocyanic Acids in the Presence of One Another.

In one portion the cyanogen is determined according to Liebig. A second portion is treated with an excess of $\frac{N}{10}$ silver solution, acidified with nitric acid, filtered, the precipitate washed with water, and the excess of silver in the filtrate determined according to Volhard. The filter containing the precipitate is washed by means of concentrated nitric acid into a flask and boiled for three-quarters of an hour. By this means the cyanide and sulphocyanate of silver go into solution, while the silver chloride remains undissolved. The solution is diluted to about 100 c.c., a sufficient amount of barium nitrate is added to precipitate the sulphuric acid formed, and the silver corresponding to the cyanide and sulphocyanate is titrated with potassium sulphocyanate without filtering off the silver chloride or barium sulphate.

The calculation is accomplished as follows:

1. For the titration of the cyanide in alkaline solution, t c.c. $\frac{N}{10}$ silver solution were necessary, and for the precipitation of the same amount of cyanogen in acid solution $2t$ c.c. $\frac{N}{10}$ silver solution were required.

2. For the precipitation of the chlorine + cyanogen + sulphocyanogen in acid solution, T c.c. of $\frac{N}{10}$ silver solution were used.

3. Finally, t_1 c.c. $\frac{N}{10}$ KCNS solution were used for the precipitation of the silver cyanide + sulphocyanide.

Then

1. Cyanogen = $t \times 0.005202$ gm. CN.

2. Sulphocyanogen = $(t_1 - 2t) \times 0.005808$ gm. CNS.

3. Chlorine = $(T - t_1) \times 0.003546$ gm. Cl.

8. Determination of Sulphuric Acid by Benzidine Hydrochloride.*

$$1000 \text{ c.c. } \frac{N}{10} \text{ NaOH} = \frac{\text{H}_2\text{SO}_4}{20} = \frac{98.086}{20} = 4.904 \text{ gms. H}_2\text{SO}_4.$$

Benzidine, $\text{C}_{12}\text{H}_8(\text{NH}_2)_2$, is a weak organic base. It forms stable salts with strong mineral acids, of which the sulphate is characterized by its slight solubility, particularly in water containing hydrochloric acid. The base itself is neutral toward phenolphthaleïn. On account of being such a weak base, therefore, the aqueous solutions of its salts undergo hydrolysis. Thus benzidine hydrochloride is decomposed according to the equation:

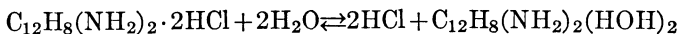

into hydrochloric acid and benzidine hydroxide, and the latter breaks down further into benzidine and water:

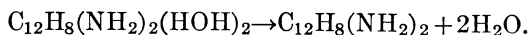

In other words, an aqueous solution of benzidine hydrochloride behaves like a mixture of hydrochloric acid and benzidine, and the amount of acid present may be titrated with alkali, using phenolphthaleïn as indicator.

There are two methods which have been used for the volumetric estimation of sulphuric acid by means of benzidine. Müller treated the *neutral* solution of the sulphate with a solution of benzidine hydrochloride of known acidity.

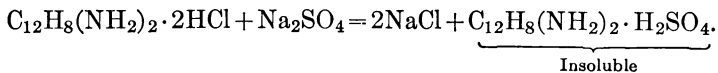

The precipitate of benzidine sulphate was filtered off and the filtrate titrated with a standard solution of alkali. The loss in

† W. Müller, Ber., **35**, 1587 (1902); Müller and Dürkes, Z. anal. Chem., **42**, 477 (1903); F. Raschig, Z. angew. Chem., 1903, 617 and 818; von Knorre, Chem. Ind., **28**, 2; and Friedheim and Nydegger, Z. angew. Chem., 1907, 9.

acidity corresponded to the amount of sulphuric acid present. Raschig, on the other hand, recommends treating the neutral or acid solution of the sulphate with benzidine hydrochloride solution, filtering off the precipitated benzidine sulphate, washing it, and then suspending it in water and titrating the sulphuric acid with tenth-normal sodium hydroxide.

The latter method constitutes a direct determination and has the advantage that it does not require a neutralization of the solution before the treatment with benzidine hydrochloride.

In the precipitation of sulphuric acid by means of benzidine, there are two sources of error. In the first place the precipitate is not perfectly insoluble, so that an appreciable amount of sulphuric acid is not precipitated. In the second place, the precipitate tends to adsorb some benzidine hydrochloride. These two sources of error influence the results of an analysis in opposite directions and either wholly or partly compensate one another. Friedheim and Nydegger have studied the method from this point of view and have apparently succeeded in working out the conditions whereby the sum of the errors becomes practically zero.

Procedure.—To prepare the solution of benzidine hydrochloride, 6.7 gms. of the free base, or the corresponding amount of the hydrochloride,* is rubbed up in a mortar with 20 c.c. of water. The paste is rinsed into a liter flask, 20 c.c. of hydrochloric acid (sp. gr. 1.12) are added, and the solution diluted up to the mark. (1 c.c. of this solution corresponds theoretically to 0.00357 gms. H_2SO_4 .) The solution has a brown color and may be filtered if necessary. After some time brown flakes are likely to separate, but these do no harm.

The solution of the sulphate is diluted with water until its volume corresponds to not less than 50 c.c. for each 0.1 gm. of sulphuric acid present. An equal volume of the reagent is added while stirring vigorously. A filter is prepared by placing a Witt perforated porcelain filter plate in a funnel and covering it with two moistened filter papers, one of exactly the same size as the

* The commercial salt contains varying amounts of hydrochloric acid. This can be determined by titration with alkali.

plate and the upper one a little larger. After ten minutes, the precipitate is filtered off upon this filter, using gentle suction. The last portions of the precipitate are transferred to the filter with the aid of small portions of the clear filtrate, and then the beaker and precipitate are washed with 20 c.c. of cold water, added in several portions. The precipitate and filter, but not the plate, are then transferred to an Erlenmeyer flask, 50 c.c. of water are added and the contents of the stoppered beaker shaken until a homogeneous paste is obtained. The rubber stopper is then removed from the flask, rinsed off with water, a drop of phenolphthalein added, the water heated to about 50° and titrated with tenth-normal sodium hydroxide. When the end point is nearly reached, the liquid is boiled for five minutes, and the titration then finished.

Remark.—According to Friedheim and Nydegger, this method gives excellent results in the analysis of all sulphates provided no substances are present which attack benzidine, and provided the amount of other salts and acids present is not too great. There should not be more than 10 mol. of HCl, 15 mol. HNO₃, 20 mol. HC₂H₃O₂, 5 mol. alkali salt, or 2 mol. ferric iron present to 1 mol. H₂SO₄. A satisfactory determination of the sulphur in pyrite may be made by dissolving 0.5 of the sample according to the Lunge method (see p. 362), evaporating off the nitric acid, taking up the residue in a little hydrochloric acid, diluting to 500 c.c. and using 100 c.c. for the treatment with benzidine hydrochloride.

9. Determination of Sulphuric Acid: (Hinman).*

$$1000 \text{ c.c. } \frac{N}{10} \text{Na}_2\text{S}_2\text{O}_3 = \frac{\text{H}_2\text{SO}_4}{30} = \frac{98.08}{30} = 3.269 \text{ gms. H}_2\text{SO}_4.$$

This method depends upon the fact that barium chromate is easily dissolved by dilute hydrochloric acid while barium sulphate is not; 1 liter of cold water dissolves about 2 mg. of BaSO₄ and 3 mg. of BaCrO₄ but the latter salt dissolves easily in acid because HCrO₄⁻ as an acid is comparable to H₂CO₃. If a solution

* Am. J. Sci. and Arts, 114, 478 (1877). Cf. Andrews, Am. Chem. J., 2, 567; Pennock and Morton, J. Am. Chem. Soc., 1903, 2265; Bruhns, Z. anal. Chem., 45, 573 (1906); Holliger, *Ibid.*, 19, 84 (1910), and M. Reuter, Chem. Ztg., 1898, 357.

of barium chromate in dilute hydrochloric acid is added in slight excess to a solution containing SO_4^{--} ions, BaSO_4 is precipitated; then upon neutralizing the solution the remainder of the barium is precipitated as BaCrO_4 , leaving one mole of CrO_4^{--} in solution for each mole of SO_4^{--} originally present. After filtering, the dissolved chromium can be determined iodometrically (p. 649).

The method is rapid and capable of giving theoretical values in the analysis of sulphates containing less than 5 per cent of SO_3 . By slightly varying the conditions, however, the results are influenced and the most favorable conditions are not always the same for different sulphates. The method, therefore, is suitable for routine work, but is not theoretically perfect.*

The results are likely to be high,—(1) If the barium chromate contains any water-soluble chromate. Since the solubility of barium chromate in hot water is appreciable there will always be a positive error from this source, if the solution is filtered hot.

The results will be low,—(1) If there is any reduction of chromate other than the desired reduction with iodide; this may be caused by the presence of too much hydrochloric acid during the first precipitation. (2) If any other chromate is precipitated with the barium chromate, such as basic ferric chromate. (3) If the solution is not acid enough during the treatment with iodide the reduction of the chromate is likely to be incomplete. (4) If the solution is hot, or contains an insufficient amount of iodide there is likely to be some loss of the iodine.

The barium chromate reagent is prepared by precipitating barium chloride with potassium chromate at the boiling temperature. The precipitate is washed with hot, dilute acetic acid and then with water till free from chromate. From 2 to 4 gms. of the dry salt are dissolved in one liter of normal hydrochloric acid. 1 c.c. should precipitate 0.63 mg. to 1.2 mg. of SO_3 .

* In some cases it is simplest to apply a correction factor. Thus Komarowsky (*Chem. Ztg.*, **31**, 498 (1907)) deducts 0.3 c.c. from the final burette reading. J. Lurie, at the Mass. Inst. Tech., was able to modify the directions so that correct results could be obtained with several sulphates.

Procedure.—If the solution of the sulphate is acid, nearly neutralize it with caustic alkali solution. Dilute with water until not more than about 5 mg. of SO_3 is present in 100 c.c. Heat to boiling and slowly add a slight excess of the barium chromate reagent. Boil for one minute or for five minutes if any carbonate was present.

To the boiling solution cautiously add pure CaCO_3 in small portions until present in slight excess (use ammonia if iron, nickel or zinc is present). Cool to room temperature and bring to a definite volume in a calibrated flask. Filter through a dry filter and take 100 c.c. of the filtrate for the titration.

Add 2 or 3 gm. of potassium iodide and 5 c.c. of concentrated hydrochloric acid. Shake well and allow to stand 15 minutes. Then titrate slowly with 0.02 normal sodium thiosulphate solution.

Remark.—When iron, nickel or zinc salts are contained in the solution, the acid present cannot be neutralized with calcium carbonate, because these salts when boiled with calcium carbonate and a soluble chromate form insoluble basic chromates, so that too little chromic acid will be found in the filtrate corresponding to too little sulphuric acid. In such a case the neutralization is effected with ammonia, an excess being added, the solution boiled until the excess is almost entirely expelled and then filtered.

10. Determination of Phosphoric Acid. Method of Pincus.

Principle.—If a neutral solution, or one slightly acid with acetic acid, is treated with uranyl acetate, a greenish-white precipitate of uranyl phosphate is formed:



If at the same time ammonium salts are present, ammonium is contained in the precipitate:

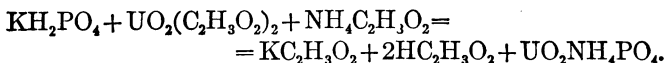

The end of the precipitation is determined by testing a drop of the solution on a porcelain tile with potassium ferrocyanide.

As soon as all of the phosphoric acid is precipitated and the solution contains a trace of uranyl acetate in excess, the ferrocyanide solution produces a brown coloration.

In order to completely precipitate the phosphoric acid, it is necessary to titrate in a boiling hot solution. As, however, a solution of calcium phosphate will become turbid on boiling, owing to the formation of secondary calcium phosphate (CaHPO_4), it is best to precipitate the greater part of the phosphoric acid in the cold, then heat to boiling and complete the titration.

Requirements. 1. *Potassium Phosphate Solution.*—This is obtained by dissolving 19.17 gms. (corresponding to 10 gms. P_2O_5) of chemically pure monopotassium phosphate (which can be obtained commercially) in 1 liter of water.

The concentration of the solution is confirmed by evaporating 50 c.c. to dryness in a large platinum crucible, igniting the residue over the full flame of a Bunsen burner and weighing as KPO_3 ; also by precipitating another portion as magnesium ammonium phosphate and weighing as magnesium pyrophosphate.

50 c.c. of the solution correspond to 0.5 gm. P_2O_5
 and should yield. 0.8315 gm. KPO_3
 and. 0.7839 gm. $\text{Mg}_2\text{P}_2\text{O}_7$.

2. *Calcium Phosphate Solution.*—5.461 gms. of $\text{Ca}_3\text{P}_2\text{O}_8$, corresponding to 2.5 gms. P_2O_5 , are dissolved in a little nitric acid, diluted with water to a volume of 1 liter, and the concentration of the solution tested by means of the molybdate method of Woy (p. 437).

3. *Uranyl Acetate Solution.*—This is made by dissolving about 35 gms. of uranyl acetate in a liter of water.

4. *Ammonium Acetate Solution.*—100 gms. of pure ammonium acetate and 100 c.c. of acetic acid, sp. gr. 1.04, are diluted with water to a volume of 1 liter.

5. *Potassium Ferrocyanide.*—The salt is used in the powdered form.

Procedure.

(a) Standardization of the Uranium Solution.

50 c.c. of the potassium phosphate, or calcium phosphate, solution are treated with 10 c.c. of the ammonium acetate solution,

and to it the uranyl acetate solution is run in from a burette until a drop of the solution will show a brown coloration when treated with solid potassium ferrocyanide upon a white porcelain tile. The solution is then heated to boiling, when a drop of it will no longer react with the ferrocyanide. To the hot solution more of the uranium solution is added, until the brown color is obtained once more.

If for the precipitation of the phosphoric acid contained in 50 c.c. of the potassium phosphate solution (0.5 gm. P_2O_5), T c.c. of the uranium solution were required, its concentration is $\frac{0.5}{T}$ gm. P_2O_5 per c.c.

For the analysis of alkali phosphates, the solution is standardized against the potassium phosphate solution, while for the analysis of an alkaline-earth phosphate the solution of calcium phosphate is used.

(b) Determination of Phosphoric Acid in Alkali Phosphates.

The solution to be analyzed should be of about the same concentration as that of the potassium phosphate used for the standardization, and titrated as above. Phosphate solutions of different concentrations give different results by the titration.

(c) Determination of Phosphoric Acid in Calcium Phosphate.

A weighed amount of calcium phosphate is dissolved in dilute nitric acid, ammonia is added to the solution until a permanent precipitate is produced, which is redissolved in a little acetic acid, 10 c.c. of the ammonium acetate solution are added, and the solution is titrated with the standardized solution of uranyl acetate.

Remark.—In the presence of iron and aluminium this method will not give accurate results because the phosphates of these metals are insoluble in acetic acid. In such cases, the turbid acetic acid solution is filtered and the phosphoric acid determined in the filtrate by the above titration. The precipitate consisting of iron and aluminium phosphates is ignited, weighed, and, if it amounts to less than 0.01 gm., half its weight is taken as P_2O_5 ;

otherwise the phosphoric acid in the precipitate must be determined by the molybdate method.

II. Determination of Nickel by Potassium Cyanide.*

This method, which permits the volumetric estimation of nickel with speed and accuracy even in the presence of iron, manganese, chromium, zinc, vanadium, molybdenum, and tungsten, depends upon the fact that nickel ions react with potassium cyanide in slightly ammoniacal solution, to form a complex anion, $[\text{Ni}(\text{CN})_4]^-$,

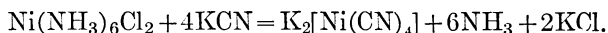

If the solution of the nickel salt contains a precipitate of silver iodide, produced by adding a known amount of silver nitrate and a few drops of potassium iodide solution, the turbidity will not disappear until all of the nickel has entered into reaction with the potassium cyanide.

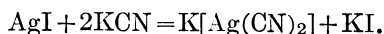

The titration is finished by adding just enough more silver nitrate to cause the precipitate of silver iodide to reappear.

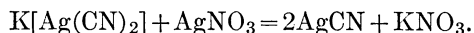

Requirements.—The potassium cyanide solution should be about equivalent to a tenth-normal silver solution, and is prepared by dissolving 13.5 gms. of pure potassium cyanide and 5 gms. of caustic potash in water and diluting to a volume of one liter. The addition of the alkali serves to make the solution more stable.

The silver nitrate solution is made exactly tenth-normal and is prepared by dissolving 8.495 gms. AgNO_3 in water and diluting to exactly 500 c.c. 1 c.c. of this solution is equivalent to 0.01392 gms. KCN, or to 0.002934 gms. Ni. It is used for standardizing the potassium cyanide solution, and in the analysis itself.

The potassium iodide solution contains 2 gms. KI in 100 c.c.

* Cf. Campbell and Andrews, *J. Am. Chem. Soc.*, **17**, 126 (1895); Moore, *Chem. News* **72**, 92 (1895); Goutal, *Z. angew. Chem.*, **1898**, 177; Brearley and Jarvis, *Chem. News*, **78**, 177 and 190 (1898); Johnson, *J. Am. Chem. Soc.*, **29**, 1201 (1907); Campbell and Arthur *ibid.*, **30**, 1116 (1908); and Grossmann, *Chem. Ztg.*, **32**, 1223 (1908).

Standardization of the Potassium Cyanide Solution.—About 30 c.c. of the potassium cyanide solution are diluted to 100 c.c., 5 c.c. of the potassium iodide solution added, and the solution titrated with silver nitrate solution until a faint permanent opalescence is obtained which is cleared up by a small drop of potassium cyanide solution.

Analysis.—The solution, containing not more than 0.1 gm. of nickel and having a volume of about 100 c.c., is treated with ammonia until slightly alkaline* and then with 5 c.c. of the potassium iodide solution and 0.5 c.c. of the 0.1N silver nitrate solution, the latter being accurately measured from a burette. While stirring constantly with a glass rod, the standard potassium cyanide solution is added until the precipitated silver iodide dissolves completely. Then the silver solution is added until a faint, permanent opalescence is obtained which is cleared up by a small drop of the potassium cyanide.

Assuming that the silver solution was exactly tenth-normal, that one c.c. of potassium cyanide = t_1 c.c. of the silver nitrate solution, and that T c.c. of potassium cyanide and t c.c. of silver nitrate were used in titrating a gms. of a substance, then the percentage of nickel is found by the following equation:

$$\frac{(Tt_1 - t) \times 0.2934}{a} = \text{per cent. Ni.}$$

Instead of working with two solutions, F. Sutton † states that equally reliable results can be obtained by using a potassium cyanide solution to which a little silver nitrate has been added. Thus, to the above solution of potassium cyanide there may be added about 0.50 gm. of silver nitrate which is first dissolved in water by itself. If this solution is used for titrating a nickel solution to which potassium iodide solution has been added, a precipitate of silver iodide is formed at once which increases with the further addition of the potassium cyanide-silver nitrate solution until all the nickel is converted into potassium nickelo-

* If the addition of ammonia does not give a clear solution, a few cubic centimeters of ammonium chloride solution should be added.

† Volumetric Analysis, 8th edition, p. 252.

cyanide, but the precipitate eventually disappears upon the further addition of the solution. When this modification of the potassium cyanide method is used, however, it is necessary to standardize the potassium cyanide solution against a solution containing a known quantity of nickel.

Remarks.—The method can be carried out in the presence of most of the other elements of the ammonium sulphide group.* If copper is present in amounts not exceeding 0.4 per cent., the copper will replace almost exactly three-quarters of its weight of nickel. In case chromium is present, the dark color due to presence of chromic salts may be obviated by adding to the original sulphuric acid solution a 2 per cent. solution of potassium permanganate until a slight permanent precipitate of manganese dioxide is obtained, whereby the chromium is oxidized to chromic acid. The solution is filtered, concentrated in a 400 c.c. beaker to about 60 c.c., then treated with sodium pyrophosphate, as described above. The method is not applicable in the presence of cobalt, the presence of which is betrayed by the solution assuming a dark color upon the addition of potassium cyanide, but when the amount of the latter does not exceed one-tenth the amount of nickel present, the titration can be carried out successfully and the results represent the amount of nickel and cobalt present.

The temperature of the solution should not be much above 20°, for in hot solutions the results are not concordant. The quantity of ammonia present should not be too great, because the tendency is for ammonia to impede the reaction if more than a slight excess is present. Potassium cyanide containing sulphide cannot be used; the reagent should be the purest obtainable. The results are accurate. The method has been modified so that it can be used to advantage for the

Determination of Nickel in Nickel Steel.

One gram of steel is dissolved in a casserole with 10 to 15 c.c. of nitric acid (sp. gr. 1.2), adding a little hydrochloric acid if necessary. After the steel has dissolved, 6 or 8 c.c. of sulphuric

* The addition of alkali pyrophosphate is usually necessary, as in the following method for determining nickel in steel.

acid (1:1) are added, and the solution is evaporated until fumes of sulphuric anhydride begin to come off. The residue is cooled, 30 to 40 c.c. of water are added, and the contents of the casserole boiled until the ferric sulphate has all dissolved. The solution is then transferred to a 400-c.c. beaker, filtering if necessary, and 13 gms. of sodium pyrophosphate* dissolved in 60 c.c. of water at about 60° are added. The pyrophosphate solution must not be boiled, as this causes the formation of normal phosphate. The addition of the sodium pyrophosphate causes the formation of a heavy white precipitate of ferric pyrophosphate. The liquid is cooled to room temperature, whereupon dilute ammonia (1:1) is added drop by drop, while stirring constantly, until the greater part of the precipitate has dissolved and the solution has assumed a greenish tinge. At this point, it should react alkaline toward litmus and smell slightly, but not too strongly, of ammonia. Now on gently heating the solution, while stirring, the remainder of the pyrophosphate will dissolve, giving a perfectly clear light green solution. If the ammonia is added too fast, or the solution is not carefully stirred, a brownish color is likely to result, but this can usually be overcome by carefully adding a few drops of dilute sulphuric acid. The clear solution is cooled to room temperature and 0.5 c.c. of the standard silver nitrate solution is added together with 5 c.c. of the potassium iodide. The solution is then titrated with potassium cyanide, which is added until the precipitate of silver iodide has disappeared. The titration is finished by adding just enough more of the silver nitrate to cause the formation of a slight turbidity again.

* Instead of using sodium pyrophosphate to prevent the interference of iron and other metals, many chemists use citric or tartaric acid. In this case the solution is dark colored and the end-point a little harder to detect.

12. Determination of Copper by the Potassium Cyanide Method.*

Principle.—If an ammoniacal solution of a cupric salt is treated with potassium cyanide, the intense blue color gradually disappears. The reaction is essentially as follows:

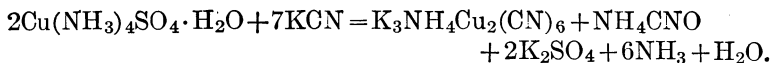

The temperature of the solution, the ammonia concentration, and the quantity of ammonium salts present effect the reaction so that a given quantity of copper does not always react with the same quantity of potassium cyanide. The potassium cyanide solution, therefore, must be standardized under exactly the same conditions as under which the analysis is carried out.

Standardization of the Potassium Cyanide Solution.—Twenty grams of pure potassium cyanide are dissolved in a liter of water and the solution titrated against pure copper. About 0.2 gm. of pure copper wire or foil is weighed out into a 200-c.c. Erlenmeyer flask and dissolved in 5 c.c. of concentrated nitric acid. After solution is complete, 25 c.c. of water and 5 c.c. of bromine water are added and the solution boiled to expel the excess of bromine. Then 50 c.c. of water and 10 c.c. of strong ammonia (sp. gr. 0.90) are added, the solution cooled to room temperature by placing the flask in cold water, and the potassium cyanide added slowly from a burette, while constantly rotating the contents of the flask. When the solution has become a pale blue, water is added to make the total volume 150 c.c. and the addition of the potassium cyanide continued until the solution is just decolorized. The weighed amount of copper divided by the number of cubic centimeters of potassium cyanide required gives the titer of the solution.

Low's Method for Analyzing Copper Ores.—About 0.5 gm. of a rich ore, or from two to four times as much of a low-grade ore, is weighed into a 200-c.c. Erlenmeyer flask and treated with 6–10 c.c. of concentrated nitric acid and boiled until nearly all

* Cf. Steinbeck, Z. anal. Chem. 8, 8 (1869). Dulin, J. Am. Chem. Soc., 17, 346. A. H. Low, Technical Methods of Ore Analysis.

the red fumes are expelled. If necessary, 5 c.c. of concentrated hydrochloric acid are also added to decompose the ore and the boiling continued for a short time. After cooling somewhat, 7 c.c. of concentrated sulphuric acid are added and the solution evaporated until dense fumes of sulphuric acid are evolved. Then, after allowing to cool somewhat, 25 c.c. of cold water are added and a drop of concentrated hydrochloric acid to precipitate any silver as chloride. The liquid is boiled to dissolve the copper and ferric sulphates and then the precipitated lead sulphate and silicious residue is filtered off and washed with hot water. The filtrate is received in a beaker of about 6 cm. diameter and care is taken not to let the filtrate exceed 75 c.c.

The copper is precipitated from the filtrate by introducing a piece of aluminium foil, about 14 cm. long and 2.5 cm. wide, which is bent into a triangle. The beaker is covered with a watch-glass and its contents boiled about ten minutes, whereby nearly all the copper is deposited as spongy metal. The beaker is now removed from the flame and the sides washed down with cold water. To precipitate the last traces of copper and to prevent the oxidation of the fine deposit, 15 c.c. of strong hydrogen sulphide water are added, after which the liquid is decanted through a 9 cm. filter. The copper is washed off the aluminium by means of weak hydrogen sulphide water into the flask in which the ore was dissolved and the liquid decanted through the filter; the beaker containing the aluminium foil and some copper is set aside temporarily. The operation of filtering should take place without interruption and the filter kept well filled with liquid to prevent the oxidation of any precipitate upon it, which would cause it to dissolve and give a turbid filtrate. After washing the deposit four times, using in each case 20 c.c. of weak hydrogen sulphide water, the liquid is allowed to drain from the funnel, and then the beaker containing the filtrate is replaced by the flask containing the deposited copper. The aluminium foil, to which some copper usually adheres, is now covered with 10 c.c. of nitric acid (1:1), heated nearly to boiling, and the hot acid poured through the filter. The flask is replaced by the beaker containing the foil, and the contents of the flask heated until all the copper is dissolved and the greater part of the red

fumes expelled. The flask is again placed under the funnel, the aluminium foil in the beaker covered with 5 c.c. of strong bromine water, which is poured through the filter. The aluminium foil and the filter are then washed with hot water. The solution is boiled to expel the excess of bromine, cooled to room temperature, treated with 10 c.c. of strong ammonia, and titrated with potassium cyanide exactly as in the standardization.

13. Determination of Lead by the Molybdate Method.*

Principle.—The lead is precipitated as molybdate from an acid solution and the termination of the reaction is recognized by testing a drop of the solution with a drop of tannin solution, which gives a yellow coloration when an excess of ammonium molybdate is present.

Requirements.—1. A solution of ammonium molybdate prepared by dissolving about 4.25 gms. of ammonium molybdate in water, and diluting to one liter.

2. A freshly prepared tannin solution containing 0.1 gm. of tannin in 20 c.c. of water.

Standardization of the Ammonium Molybdate Solution.—About 0.2 gm. of pure lead foil is weighed into a 200-c.c. Erlenmeyer flask, dissolved in a mixture of 2 c.c. concentrated nitric acid and 4 c.c. of water and the solution evaporated nearly, if not quite, to dryness. The residue is taken up in 30 c.c. water, 5 c.c. of concentrated sulphuric acid added, the liquid shaken, the lead sulphate allowed to settle completely, filtered and washed with dilute sulphuric acid (1 : 10). The filter, together with precipitate, is thrown into an Erlenmeyer flask, 10 c.c. of concentrated hydrochloric acid are added, and the liquid boiled until the filter is completely disintegrated. Then, after adding 15 c.c. more of the concentrated hydrochloric acid, and 25 c.c. of cold water, 25 c.c. of concentrated ammonia (sp. gr. 0.90) are carefully poured into the flask, whereby the greater part of the acid is neutralized. A piece of blue litmus paper is thrown into the solution, ammonia is added to slightly alkaline reaction, and then glacial acetic

* Low, Technical Methods of Ore Analysis.

acid until the litmus paper turns red. The solution is diluted to about 200 c.c. with hot water and about two-thirds of the solution transferred to a beaker. The ammonium molybdate solution is added to the latter from a burette until a drop of the solution, brought in contact with a drop of the tannin indicator upon a white porcelain tile, gives a brown or yellow color. Some more of the lead solution is added to the beaker and the operation is repeated until finally but a few cubic centimeters of the lead solution remain in the flask. The contents of the beaker are now poured into the flask, then back again to the beaker, and the titration finished by adding the molybdate solution two drops at a time. If t c.c. of molybdate are used in titrating a gms. of lead the titer of the solution is

$$1 \text{ c.c. ammonium molybdate} = \frac{a}{t} \text{ gm. lead.}$$

Procedure.—0.5 gm. of the ore is weighed into a 200-c.c. Erlenmeyer flask, 10 c.c. of concentrated hydrochloric acid and 20 c.c. of water added and the liquid boiled until all the hydrogen sulphide is expelled. If the ore should not dissolve completely by this treatment, a little concentrated nitric acid is added and the heating continued until the ore is completely decomposed. As soon as this has taken place, the solution is allowed to cool, 7 c.c. of concentrated sulphuric acid added, and the liquid evaporated over a free flame until dense vapors of sulphuric acid are evolved. After allowing to cool, 20 c.c. of water are added and the liquid boiled for fifteen minutes in order to dissolve all the anhydrous ferric sulphate.

After cooling, the precipitated lead sulphate and silicious residue is filtered off and washed with cold dilute sulphuric acid (1:10). The lead sulphate is often contaminated with calcium or barium sulphate, and before the titration it must be purified. To this end, the precipitate is rinsed by a stream of cold water into the original flask, 5 gms. of pure ammonium chloride are added and about 1 c.c. of concentrated hydrochloric acid. By boiling, all of the lead and calcium sulphates are dissolved but the gangue, which is easily distinguished from either of the above salts, remains behind. The solution is neutralized with ammonia and treated

with an excess of ammonium sulphide. The precipitate is allowed to settle and is then filtered and washed with hot water until the filtrate no longer gives a test for calcium when tested with ammonium oxalate. As the lead sulphide may be contaminated with some iron sulphide, it is again rinsed into the original flask, by means of as little hot water as possible, treated with 5 c.c. of dilute sulphuric acid, shaken until the precipitate is well broken up, treated with 25 c.c. of strong hydrogen sulphide water, filtered through the same filter as was last used, and washed with cold water. By this time it is safe to assume that the lead sulphide is free from all calcium and iron. The filter and precipitate are once more returned to the original flask, dissolved by boiling with 5 c.c. of concentrated hydrochloric acid, boiled, and then, when the hydrogen sulphide is practically all expelled, treated with 2 or 3 drops of concentrated nitric acid to remove the last traces of hydrogen sulphide. Now 25 c.c. of cold water are added, and the solution treated exactly as in the standardization of the ammonium molybdate.

Remark.—The smelter chemists in the western part of the United States use a much more rapid method, which gives good results in the hands of an experienced operator, provided the lead content of the ore is greater than fifteen milligrams.

*Procedure.**—The ore is dissolved in hydrochloric acid or hydrochloric and nitric acids, and the solution is filtered while hot without diluting any more than to prevent the acid attacking the paper. The residue is washed rapidly with a hot solution of ammonium chloride until the washings show no blackening when tested with ammonia and a drop of ammonium sulphide. The filtrate is made just alkaline with ammonia and a slight excess of ammonium sulphide added. The liquid is heated to boiling and the precipitated sulphides are filtered off and washed with hot water. (The alkaline earths may be determined in the filtrate if desired.) The sulphides are dissolved in hot, dilute nitric acid and the resulting solution is caught in the same beaker in which the sulphides were precipitated. About 7 c.c. of concentrated sulphuric acid are added and the

* This method was obtained through the courtesy of Mr. Franklin G. Hills of the American Smelting and Refining Co.

liquid evaporated until dense vapors of sulphuric acid are evolved. After allowing to cool, 20 c.c. of water are added and the liquid boiled to dissolve the anhydrous ferric sulphate. The precipitated lead sulphate is filtered off, washed free from acid, dissolved in a slight excess of ammonium acetate solution* and diluted with water. After heating to boiling, the hot solution is titrated with ammonium molybdate.

The above procedure serves when alkaline earths are present; but when these are known to be absent, the original solution of the ore is at once evaporated with sulphuric acid and the resulting lead sulphate can be dissolved in ammonium acetate solution and titrated without any purification.

* If too much ammonium acetate solution is used, a transitory end point is obtained in the subsequent titration. It is necessary to use a hot solution, which does not contain too much of the salt. See page 176.

PART III.

GAS ANALYSIS.

THE chemical analysis of gas mixtures is accomplished usually by measuring and rarely by weighing the individual constituents, so that it is customary to express the results in per cent. by volume. But inasmuch as the volume of a gas is influenced to an extraordinary extent by the temperature and pressure, it is necessary to reduce each measurement to standard conditions of temperature and pressure, and further to take care that these remain constant during the whole of the analysis. A volume of gas V measured over water at t° C. and B mm. barometric pressure,* is reduced to the volume which it would assume at 0° C. and 760 mm. pressure in a dry condition by means of the formula

$$V_0 = \frac{V(B-w)}{760(1+\alpha t)}.$$

In this formula, V_0 represents the reduced volume,† V the volume of the gas at t° C. and B mm. pressure, w the tension of aqueous vapor, and α the expansion coefficient of the gas ($=0.003665$).

As, however, $\alpha = \frac{1}{273}$, the above formula may be written as follows:

$$V_0 = \frac{V(B-w)273}{760(273+t)}.$$

* Here is understood the barometer reading reduced to 0° C. The reduction is accomplished by means of the formula:

$$B_0 = \frac{1+\beta t}{1+\alpha t} .B,$$

in which B_0 represents the reduced reading, B the actual reading at t° , α the expansion coefficient of mercury ($=0.000181$), β the linear coefficient of expansion of glass ($=0.0000085$). For most purposes, however, the reduction to 0° C. can be made with sufficient accuracy by making the following deductions from the actual readings:

5°-12°	1 mm.	21°-28°	3 mm.
13°-20°	2 "	29°-35°	4 "

† Or volume under *standard conditions*.

Instead of reducing the observed volume to the standard conditions by computation, it can be effected mechanically by compression (see p. 388).

The Collection and Confinement of Gas Samples.

Since all gases diffuse rapidly into one another even when separated by porous solid bodies or liquids, it is evident that the collection of the sample and its preservation offers certain difficulties. If a gas is confined in a bell jar over water and thus kept out of contact with the air, it will be found that different results will be obtained in the analysis of the gas from day to day. The air gradually penetrates through the water into the bell jar and in the same way the gas within the jar gradually diffuses into the atmosphere. This process will continue until finally the composition of the gas both within and without the jar is the same. The rapidity of the diffusion depends upon the extent to which the gases are absorbed by the liquid which separates them. Those liquids which absorb the gases readily, allow them to pass through it rapidly, and consequently cannot be used for keeping the gases apart. Of all liquids, mercury is best suited for the purpose, because it absorbs only minimum amounts of the different gases.

Gases which combine chemically with mercury, such as chlorine, bromine vapors, hydrogen sulphide, etc., cannot, of course, be collected over mercury; it is best to collect them in dry glass tubes and to seal the latter by fusing together the open ends in case the gas cannot be analyzed immediately. Through glass there is no diffusion, so that gases may be kept unchanged in sealed tubes for years.

If the gas is to be analyzed within a few days after the time of collection, it can be kept in pipette-shaped tubes. The ends are closed by thick pieces of rubber tubing into each of which is inserted a piece of glass stirring-rod with rounded ends; where the rubber tubing comes in contact with the glass it should be fastened tightly with wires. It is not permissible to keep gases in such tubes for a considerable length of time, for rubber, particularly when it has become hard, permits the diffusion of gases to some extent.

For less accurate analyses, the gases may be collected over water which has been previously saturated with the gas to be analyzed, and the analysis must be made immediately afterwards.

From what has been said, it is evident that care must be taken in collecting and keeping the gas to be analyzed. We will now consider briefly a few practical examples.

(a) *Collection of Gases in Accessible Places.*

1. The neck of a 200-c.c. flask is drawn out somewhat and a glass tube is inserted and about 800 c.c. of the gas to be analyzed are drawn through the flask by means of suction (Fig. 98). The neck of the flask is closed by means of a rubber cap and the glass is fused together.

(b) *Collection of Gases from Inaccessible Places.*

The rubber tubing *G*, Fig. 99, is connected on one side with the aspirator *A* of about 30 liters capacity and on the other with

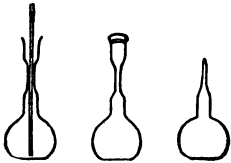

FIG. 98.

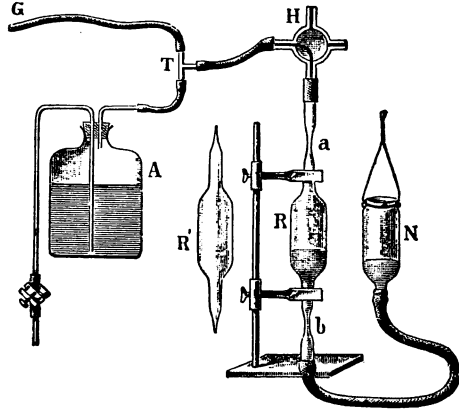

FIG. 99.

the source of the gas, and water is allowed to flow quickly from the former. After 5 or 6 liters have run out, the air is usually

completely expelled from the rubber tubing and replaced by the gas to be analyzed, so that it is now ready for collecting the sample. For this purpose the stop-cock *H* is turned 90° to the right, so that the vessel *R*, which is to receive the gas, is in communication with the outer air, and the air is expelled from it by raising the mercury reservoir *N*. The stop-cock is then turned back to the position shown in the figure and *R* is filled with the gas by lowering *N*. As the tubing between the *T* tube and the stop-cock contained impure gas, *R* is again filled with mercury and the gas expelled into the air. After the process has been repeated three times, the receiver is filled for the last time with the gas, *H* is closed, *N* is lowered so that the pressure in the tube is less than that of the atmosphere, and the ends of *R* are fused together first at *a* then at *b*. During this sealing of the tube, it should be removed from the ring-stand so that the tube can be revolved a little while being heated in the flame.

In sealing the tube, the ends are drawn out into a capillary as shown in *R'*, Fig. 99.

If it is necessary to obtain the gas from places at a very high temperature, e.g., from blast-furnaces, producers, etc., glass tubes would melt, and if ordinary iron tubes were not melted they would decompose the gas. In this case it is best to use the water-jacketed iron tube devised by St. Claire Deville and shown in Fig. 100. Cold water is run into the outer condenser at *a* and allowed to run out at *b*, and the gas is collected as described above through the tube *c*. It is important that the water should run through the tube fast enough to keep the inner tube cold, otherwise the gas will be decomposed. By this means there is no difficulty in collecting gas samples from different heights of the glowing layers of coal in blast-furnaces or producers.

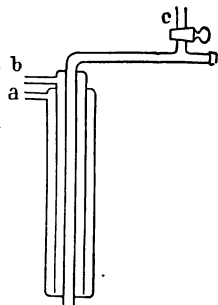

FIG. 100.

Collection of Gases Arising from Mineral Springs.

The receiver *R* is connected with the funnel *T* by means of the rubber tubing *g* (Fig. 101). All these parts of the apparatus are

filled with spring-water and the gas is allowed to ascend up through the funnel as shown in the illustration. In order that the gas may pass from the funnel into the receiver, *R* is raised so that only the tubing *p* remains in the water while the funnel is lowered as deep as possible, causing pressure enough to drive the gas over. The tubing is then closed just above *a* by means of a screw-cock, a beaker filled with spring-water is placed under *p*, the apparatus removed from the spring, and both ends of *R* are fused together with the blowpipe. If the gas is to be analyzed within two or three days,

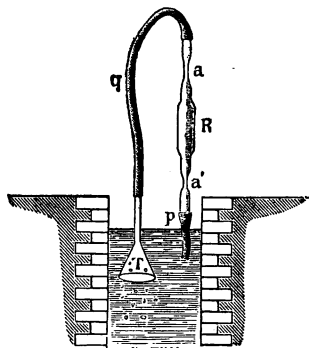

FIG. 101.

the receiver may be closed by pieces of short rubber tubing each containing a short piece of glass rod with rounded ends. All of such connections must be fastened by means of wires where the glass comes in contact with the rubber. According to the above method the gas arising from the thermal springs of Baden, Switzerland, was collected and analyzed.* The results obtained showed that it makes but little difference which method is used for closing the receiver, provided the analysis is made within a short time.†

100 c.c. of the gas contained:

* "Chemische Untersuchung der Schwefeltherme von Baden (Kanton Aargau)," by F. P. Treadwell, 1896.

† The following analyses illustrate the importance of analyzing the gas soon after it has been collected. Both samples were taken at the same time and one was analyzed promptly but the other only after two years and a half had elapsed. The gas receiver was closed by fresh rubber tubing containing a piece of stirring rod with rounded edges, and precaution was taken to wire the connections tightly. The rubber remained soft and flexible.

	I.	II.
CO ₂ =	8.52%	0.43%
O ₂ =	10.77	14.82
CO =	0.17	—
CH ₄ =	0.15	—
N ₂ =	80.39	84.75
	—	—
	100.00%	100.00%

	I	II
Nitrogen.....	69.13	69.15
Carbon dioxide .	30.81	30.90
Hydrogen sulphide.....	0.05	0.05
Oxygen.....	0.00	0.00
	99.99	100.10

Sample I was collected and the ends of the receiver fused together, while with sample II the ends were closed by means of rubber tubing and glass rods, and analyzed five days later.

Collection of Gases Absorbed in Spring-water.

Of the many different methods which have been proposed for the analyses of the absorbed gases in spring-water, the author has found the following to give the best results.

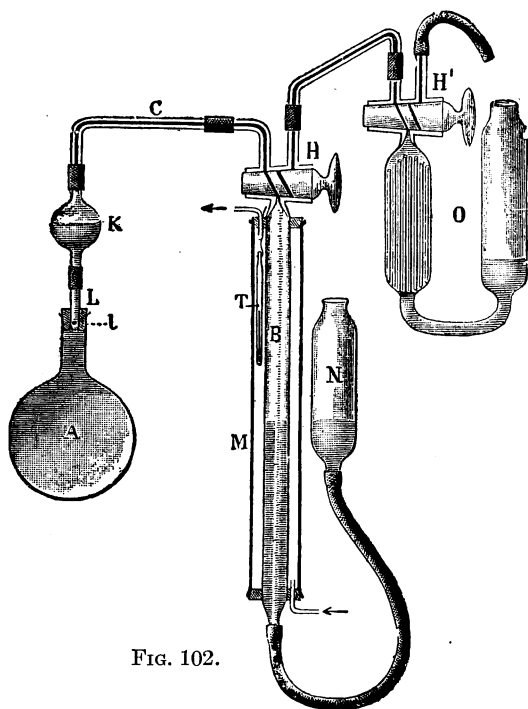

FIG. 102.

The flask A, Fig. 102, is filled with spring-water up to its upper edge and the rubber stopper containing the tube L, which is fused together at the bottom but has an opening on the side at *l*, is immediately placed in the neck and pressed down to the mark. The tube L is raised so that the opening *l* is within the stopper, thus making an air-tight connection. The bulb K is now connected with L, filled half full with distilled water and connected with the capillary tubing C, although the latter is not yet connected with

the measuring-tube *B*, as shown in the illustration. The levelling-tube *N* is next raised until mercury begins to flow out of the right-angled capillary tube, when the stop-cock *H* is closed. After this the water in the bulb *K* (which is held in an inclined position) is boiled for three minutes, meanwhile warming the capillary tubing connected with the measuring-tube. Unless this last precaution is taken, the capillary tubing is likely to break, particularly in winter. After the water in *K* has boiled vigorously for three minutes, the flame is removed, *C* is quickly connected with the measuring-tube *B* and the rubber connection is securely fastened with wire. By boiling the water in *K*, a complete vacuum is produced in the bulb, so that the gas can be at once collected from the spring-water. For this purpose the tube *L* is pressed down through the rubber stopper until the opening *l* comes just below its lower edge, the levelling-tube *N* is lowered, and the stop-cock *H* is opened. At once there is a lively evolution of gas from the water in *A* and this is subsequently maintained by warming the water. As soon as the eudiometer is full the stop-cock is closed and the volume of the gas read after bringing the mercury to the same level in *N* that it is in *B*. At the same time the temperature of the water in the condenser *M* is taken by the thermometer *T* and the barometer is read. The gas is then driven over into the Orsat tube *O* containing potassium hydroxide solution (1:2) and allowed to remain there for the time being. Meanwhile the boiling of the water in *A*, measurement of the gas in *B*, etc., are continued until finally no more gas is evolved from the spring-water. All of the gas is driven over into the Orsat tube after its volume has been noted and by means of the caustic potash, the carbonic acid is quantitatively absorbed. The unabsorbed gas is again driven over into *B* and its volume read. By correctly regulating the velocity of the current of water flowing through the condenser, it is easily possible to maintain a constant temperature throughout the whole of the experiment. The residual gas remaining after the absorption of the carbon dioxide consists usually of nitrogen, oxygen, and in some cases methane. It is transferred to the apparatus of Hempel, and analyzed according to methods which will be described further on.

According to this method, the determination of nitrogen,

oxygen, and methane gives exact results, but the apparent amount of carbon dioxide is sometimes too much and sometimes too little. If the water contains large amounts of bicarbonate in solution, the carbonic acid found will represent more than was originally present in the free state, for such substances are partly decomposed by boiling their aqueous solution. On the other hand if only a little bicarbonate is present, the result will be too low, for it is not possible to remove all of the free carbonic acid from a solution by boiling it in a vacuum.

Consequently, in all cases the free carbonic acid must be determined by computation. For this purpose, in a fresh sample of the water, the total carbonic acid is determined according to p. 393, and then if the composition of the solid constituents present is known, the volume of the free carbonic acid can be calculated.

Example.—1000 gms. of Tarasper-Lucius water contain 7.8767 gms. of total carbonic acid. Of this amount, a part of it is present in the water as carbonate ("combined" carbonic acid), an equal amount as "half-combined" carbonic acid, and the remainder is free carbonic acid. If from the total amount of carbonic acid the "combined" and "half-combined" acid is deducted (or what is the same thing, double the amount of the "combined" carbonic acid), the difference represents the amount of free carbonic acid present.

Calculation of the "Combined" Carbonic Acid.

This is obtained by multiplying the difference between the number of cations and anions (expressed in univalent ions) by the molecular weight of carbonic-acid (CO_3) ions and dividing by two,* because the sum of the cations in every salt solution is equal to that of the anions present when both are expressed in univalent ions.

The "univalent ions" are obtained by dividing the amount in grams of each element (or radical) present by its atomic (or molecular) weight and multiplying by the valence.

* For the CO_3 ion is bivalent.

(a) Calculation of the Cations.

1000 gms. Lucius water contain:

	Grams.	Combining Weight.	Valence.	Univalent Ions.
Sodium.....	3.90610	: 23.00	= 0.16983	× 1 = 0.16983
Potassium.....	0.16603	: 39.10	= 0.00425	× 1 = 0.00425
Lithium.....	0.00914	: 7.00	= 0.00131	× 1 = 0.00131
Ammonium.....	0.01298	: 18.04	= 0.00072	× 1 = 0.00072
Calcium.....	0.62691	: 40.09	= 0.01564	× 2 = 0.03128
Strontium.....	0.00879	: 87.62	= 0.00010	× 2 = 0.00020
Magnesium.....	0.19040	: 24.32	= 0.00783	× 2 = 0.01566
Iron.....	0.00603	: 55.85	= 0.00011	× 2 = 0.00022
Manganese.....	0.00021	: 54.93	= 0.000004	× 2 = 0.00001
Aluminium.....	0.00064	: 27.1	= 0.00002	× 3 = 0.00006

Sum of the cations = 0.22354

(b) Calculation of the Anions.

Chlorine (Cl).....	2.40000	: 35.46	= 0.06768	× 1 = 0.06768
Bromine (Br).....	0.02890	: 79.92	= 0.00035	× 1 = 0.00035
Iodine (I).....	0.00086	: 126.92	= 0.00001	× 1 = 0.00001
Sulphuric acid (SO ₄)....	1.72098	: 96.07	= 0.01701	× 2 = 0.03582
Boric acid (BO ₂).....	0.57600	: 43.0	= 0.01340	× 1 = 0.01340
Phosphoric acid (PO ₄)....	0.00008	: 95.0	= 0.00000	× 3 = 0.00000
Silicic acid (SiO ₃).....	0.01421	: 76.3	= 0.00019	× 2 = 0.00038

Sum of the anions = 0.11764

Sum of the cations = 0.22354

Sum of the anions = 0.11764

CO₃ anions remaining = 0.10590

expressed in univalent ions.

As CO₃ is a bivalent ion, half of this amount represents the actual amount of CO₃ ions present:

$$\frac{0.10590}{2} = 0.05295.$$

This corresponds to..... 0.05295 × 60 = 3.177 gms. CO₃
 Or the "combined" carbonic acid..... = 2.330 " CO₂

Calculation of the Free Carbonic Acid.

Total amount of carbonic acid (CO ₂) present.....	7.877	gms. per liter
Amount of "combined" carbonic acid.....	2.330	" " "
	<hr/>	
Amount of free + "half-combined" carbonic acid	.5.547	" " "
Amount of "half-combined" carbonic acid.....	2.330	" " "
	<hr/>	
Amount of free carbonic acid.....	3.217	" " "

This weight of carbon dioxide occupies 1637 c.c. under standard conditions.

By boiling 828.3 gms. of the water, 1868.9 c.c. of CO₂ were obtained at 8.4° C. and 651 mm. pressure, containing only traces of nitrogen. This corresponds to 1851.4 c.c. at 0° C. and 760 mm. pressure, per liter, which is more than the calculated amount, because the carbonic acid gas consisted partly of free and partly of "half-combined" carbonic acid.

In cases where the amount of bicarbonate present is very small, the total amount of carbonic acid obtained by boiling the water is always too small. Thus in the case of the thermal water of Baden, by boiling there was obtained:

Nitrogen	14.43	c.c. per liter
Carbon dioxide.	112.12	" " "
	<hr/>	
	126.55	" " "

while from the analysis, the free carbonic acid was computed to be 180.52 c.c. The absorbed gas in the thermal water of Baden is, therefore,

Nitrogen	14.43	c.c. per liter
Carbon dioxide	180.52	" " "
	<hr/>	
	194.95	" " "

Remark.—With the above method of collecting the gas, it is difficult to prevent some water getting into the measuring-tube *B*, by means of which a small amount of the gas will be reabsorbed. This difficulty is avoided, however, if the flask shown in Fig. 103 is used to contain the water.

This flask is provided with a short tube blown into its neck near the top and connected by means of thick-walled rubber tubing with the mercury reservoir *R*. In order to determine the contents of the flask, a scratch is made on the small tube about 4 cm. from the neck of the flask, the mercury is driven over just to this mark, and the rubber tubing tightly closed by means of a screw-cock. The reservoir is then emptied of mercury, and the flask is weighed together with the stopper, glass tube *L*, rubber tubing, and what mercury remains above *Q*. The flask is then filled with water, the stopper pressed down to the mark in the neck of the flask, and the tube *L* is raised until the lower opening

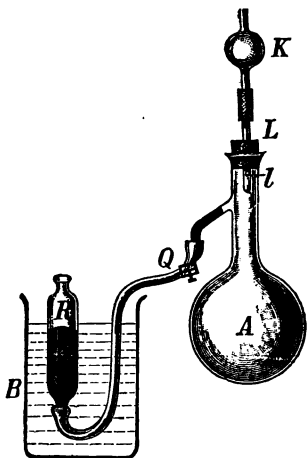

FIG. 103.

l comes within the stopper. After drying the tube *L* with blotting-paper, the flask and its contents are weighed. Its capacity is then etched upon it.

For the determination of the gases absorbed in a liquid, the flask *A* is filled with it in the same way as in the determination of its capacity, the bulb-tube *K*, half filled with distilled water is connected with *L*, and the latter is connected with a capillary tube as shown in Fig. 102. The air is removed from *K* and the capillary tubing by boiling the water in the former, as described on p. 735, and the capillary is then connected with the measuring-tube *B*, Fig. 102. The heavy rubber tubing is now connected with the reservoir as shown in Fig. 103, and the latter is placed in a beaker of hot water. The tube *L* is introduced into the neck of the flask until the opening *l* can just be seen, and the gas is expelled in the same way as described on p. 735, except that in this case the liquid is not allowed to rise so high in *K*. After three-quarters of an hour the gas will be completely expelled from the liquid. The last portions of the gas are driven over into *B* by lowering the levelling tube *N* (Fig. 102), raising the mercury

reservoir *R* (Fig. 103), and carefully opening the screw-cock *Q*. A warm stream of mercury will then flow into the flask, expelling the gas into the measuring-tube. As soon as the liquid in *A* has been driven over as far as the stop-cock *H*, this is immediately closed. Otherwise the procedure is the same as was described on p. 735.

In order to test the accuracy of this method, the author made a few determinations of the oxygen absorbed in the lake-water at Zurich, and the results were compared with those obtained by E. Martz in this laboratory by means of the method of L. Winkler (see p. 760).

OXYGEN IN 1 LITER OF ZURICH LAKE-WATER.

Modified Pettersson Method.		Method of L. Winkler.	
I 7.66 c.c.	II 7.74 c.c.	I 7.67 c.c.	II 7.75 c.c.

Collection of Gases Absorbed by Defibrinated Blood.

The author has used for this purpose the apparatus shown in Fig. 104. The experiment is carried out as follows:

First, the rubber tubing which connects *N'* and *A* is filled with mercury by raising the leveling tube *N'*, and the pinch-cock *h''* is closed. Then the gas burette *C* is likewise filled with mercury by raising *D* and the stop-cock *h* is turned to the position shown in the drawing. By raising the leveling tube *N*, the bulb *K* and the vessel *A* are filled with mercury, which is allowed to flow into the funnel *M* up to the line *a* and then the stop-cock *h* is closed. The blood to be examined is poured into *M*, *N'* is lowered, and, by carefully opening *h*, the mercury is allowed to fall from *M* until it just reached the stop-cock *h*, which is then closed. *M* is now filled with blood to the mark *b*, *h* is opened, and the blood is sucked down until its upper level is exactly at the line *a*, when *h* is closed once more. The levelling tube *N* is lowered until a good vacuum is produced in *A* and the mercury level falls to near the bottom of *K*. When this is

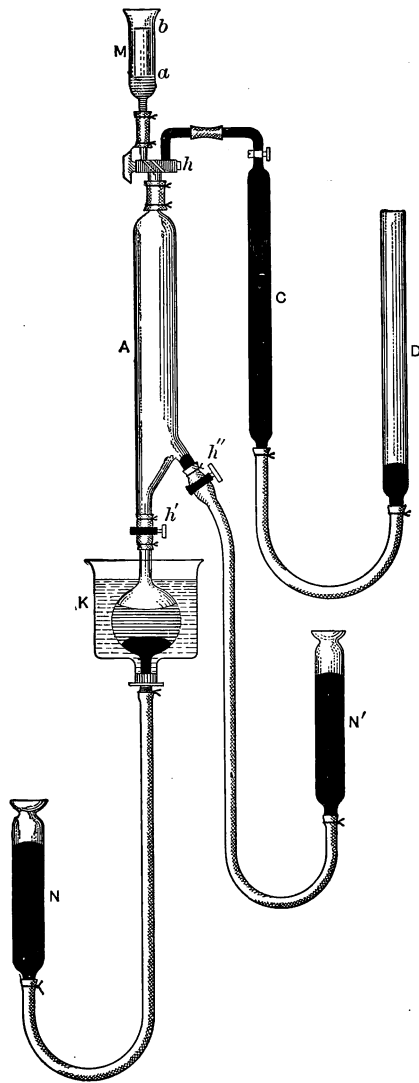

FIG. 104.

accomplished, the gas escapes from the blood so rapidly that all of *A* is filled with foam; after a few minutes, however, the effervescence subsides and all the blood collects in *K*. Then, the leveling tube *N* is raised until the blood reaches the cock *h* and the latter is then closed. In this way the greater part of the gas absorbed is separated from the blood. The leveling tube *N'* is raised, *h''* opened so that the gas in *A* is under pressure, and by properly opening *h* and the burette stop-cock, the gas is driven over into the measuring burette *C*; when this is accomplished, *h* is closed, *N'* lowered until the mercury reaches the cock *h''* which is then closed and *h'* opened. The blood again effervesces, but not so vigorously as before. The bulb *K* is now surrounded by water at 55°, which causes further effervescence from the blood. As soon as the foam subsides, the gas is again driven over into *C* and the process of evacuating is continued until the blood ceases to effervesce. The volume of the gas in *C* is finally read, the temperature and pressure noted, and the analysis carried out as described on p. 775 or 786.

The Transference of Gases in Sealed Tubes to the Apparatus Used for the Analysis.

We will assume the gas to be contained in *R*, Fig. 105. Over one of the short tubes connected with the three-way stop-cock *H* is placed a piece of thick-walled rubber tubing which contains a short piece of heavy glass tubing *r*. The stop-cock is then revolved so that the rubber tubing is above it and the latter is filled with mercury. *H* is then turned 180° toward the left so that the left and upper tubes communicate with one another. As soon as the mercury begins to run out, the stop-cock is closed. One end of *R* is then introduced into the rubber tubing containing the mercury so far that its drawn-out point reaches within *r*, and the rubber tubing is securely fastened by wiring.* In a similar way, the other end of *R* is connected with the rubber tubing filled with mercury of the levelling-tube *N*, and after this the stop-cock *H* is connected with the measuring apparatus *W* by means of the capillary tubing

* Annealed iron wire is used. Copper or brass wire would be likely to become amalgamated with mercury.

E. By raising the levelling bulb *K*, the air is expelled from *W* and the mercury is allowed to rise in the fun-

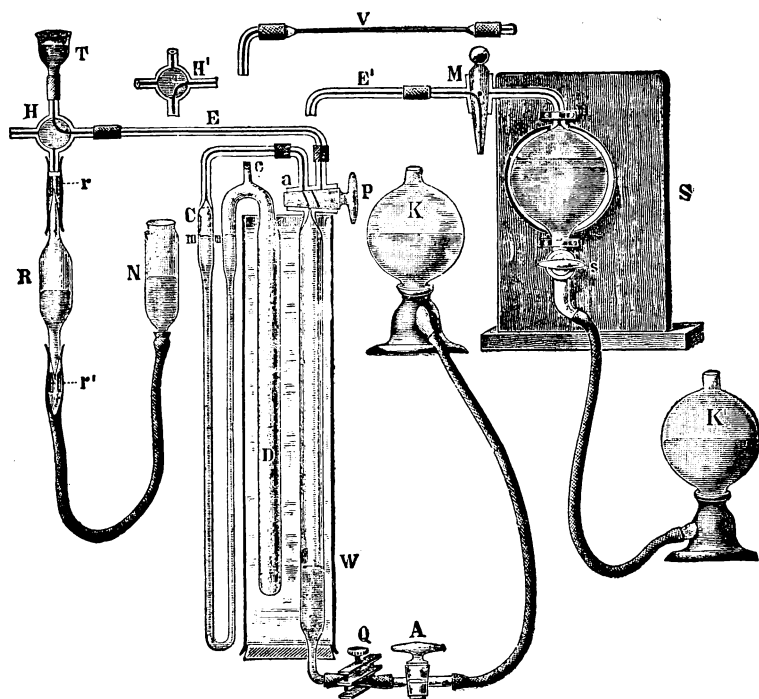

FIG. 105.

nel *T*. The stop-cock *H* is turned so that communication is established between *R* and *W*, and the ends of the former are opened by pressing the capillaries against *r* and *r'*. Then, by raising *N* and lowering *K*, the gas is readily driven over into *W*.

Calibrating Gas Measuring Vessels.

When vessels are purchased to be used in measuring gases, the correctness of the calibrations should always be tested; the testing can be done with water or with mercury. The calibration with water is carried out in exactly the same way as was described for vessels to be used in measuring liquids (cf. pp. 522-530).

The calibration by means of mercury will be illustrated by an example. We shall assume that it is desired to calibrate the apparatus shown in Fig. 106. The vessel must be thoroughly cleaned and then placed in a vertical position as shown in Fig. 106 II.

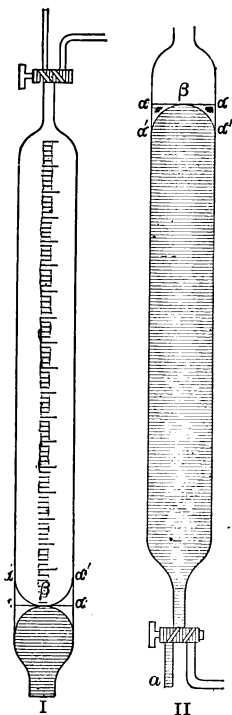

FIG. 106.

The lower capillary *a* is connected by means of thick-walled rubber tubing with a leveling vessel containing mercury, and the mercury is made to rise slowly in the vessel to a little above the upper mark. The stop-cock is then closed, the leveling tube together with the rubber tubing is removed, and the mercury allowed to flow out slowly until the highest point in the meniscus is exactly tangent to the horizontal plane through $\alpha'\alpha'$. To avoid a parallax error, the reading is taken by means of a telescope placed 2 or 3 mm. away from the glass. The whole contents of the vessel, including the space in the stop-cock, is next allowed to run into a tared flask, which is then weighed to the nearest centigram. After determining the temperature of the mercury, its volume can be found by means of the table (top of page 745) prepared by Schlösser.*

If the weight of the mercury at 20.3° amounted to 2025.26 gms., then its volume corresponds to $\frac{2025.26}{13.5483} = 149.41$. Since, however, mercury forms a convex meniscus and the volume is desired up to the plane $\alpha\alpha'$, it is evident that the volume of mercury weighed did not include the space $\alpha'\alpha-\alpha\alpha'$ and, moreover, since the instrument is to be used in the reversed position, the error is really twice as much, as is evident from the inspection of Fig. 106 I. This is called the

* Schlösser and Grimm, *Z. Chem. App.-Kunde*, **2**, 201 (1907).

WEIGHT OF 1 C.C. OF MERCURY IN AIR AT TEMPERATURES BETWEEN 15° AND 20°.
Normal temperature 15°.

Temperature Weight of Mercury.		Temperature Weight of Mercury.		Temperature Weight of Mercury.	
Deg. C.	Gms.	Deg. C.	Gms.	Deg. C.	Gms.
15	13.5593	20	13.5489	25	13.5385
15.5	13.5583	20.5	13.5479	25.5	13.5374
16	13.5573	21	13.5468	26	13.5364
16.5	13.5562	21.5	13.5458	26.5	13.5353
17	13.5552	22	13.5447	27	13.5343
17.5	13.5541	22.5	13.5437	27.5	13.5332
18	13.5531	23	13.5426	28	13.5322
18.5	13.5520	23.5	13.5416	28.5	13.5312
19	13.5510	24	13.5405	29	13.5301
19.5	13.5499	24.5	13.5395	29.5	13.5291
				30	13.5280

double meniscus correction. Its value is dependent upon the bore of the tube, as is shown by the following table:

TABLE OF MENISCUS CORRECTIONS.*

Diameter of Tube in mm.	Double Meniscus, Correction for Hg in mgs.	Double Meniscus, Correction for H ₂ O in mgs. = cubic millimeters	Simple Meniscus Cor- rection (H ₂ O—Hg) in cubic millimeters.
3	76	12	3
4	108	20	6
5	174	31	9
6	314	44	10
7	550	61	10
8	790	81	11
9	1038	106	15
10	1288	134	20
11	1540	167	27
12	1796	204	36
13	2058	245	46
14	2326	289	59
15	2596	336	72
16	2872	387	88
17	3152	441	104
18	3436	499	123
19	3726	560	143
20	4016	624	164
21	4314	691	187
22	4614	757	208
23	4920	821	229
24	5230	881	247
25	5544	938	264
26	5864	991	279
27	6185	1042	293
28	6515	1090	308
29	6845	1135	315
30	7182	1179	324

* W. Schlösser, Private Communication.

If the diameter of the vessel in question is 20 mm., then the correction, according to the table, would be 4.016 gms. and the true volume will be

$$\frac{2025.26 + 4.016}{13.5473} = \frac{2029.276}{13.5483} = 149.78.$$

The volume of this instrument, therefore, is 0.22 cm. less than the intended 150 c.c. The volume of the narrower parts of the tube can be found in a similar manner.

The diameter of the tube is best determined by filling with mercury up to a mark, then allowing it to run out until a lower mark is reached, weighing the escaped mercury, and measuring the distance between the two marks with a millimeter rule. If the weight of the mercury is p , the distance between the marks h , the temperature of the mercury 20.3° , then the

$$\text{diameter} = 2\sqrt{\frac{p}{h \times \pi \times 13.5483}}$$

In many cases it is sufficiently accurate to compute the diameter from the circumference of the tube and then subtract twice the thickness of the glass.

If it is desired to determine the total volume of a tube provided with stop-corks at both ends, the apparatus is weighed empty and then filled with mercury. In this case, it is obvious that no meniscus correction is necessary.

For a measuring vessel calibrated with water, when in a reversed position, the meniscus correction is obtained from the table on page 745. If an instrument calibrated with water is to be used subsequently with mercury, the water meniscus in calibrating the reversed tube occupies a similar position to that of the mercury meniscus when the instrument is in use (see Fig. 107) but the mercury meniscus is not so deep as that of the water. The volume of the gas is therefore found as much too large as the difference between the simple meniscus corrections ($\text{H}_2\text{O} - \text{Hg}$). Thus if the volume of a gas measuring instrument of 70 mm. diameter is found by weighing with water to be 10.167, according

to the table on page 745, then if the instrument is to be used with mercury, the gas volume will be $10.167 - 0.020 = 10.147$ c.c.

Purification of Mercury. Lothar Mayer's Method.*

The mercury used for gas-analytical operations must be purified. The principal impurities are copper, cadmium, zinc and sometimes silver and gold. The base metals are removed

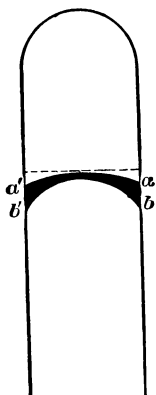

FIG. 107.

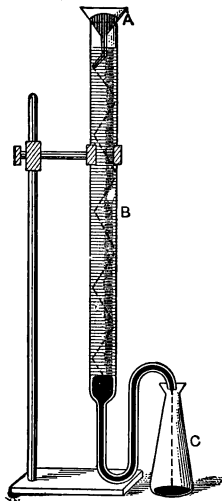

FIG. 108.

most readily by allowing the mercury to run in a fine stream through about a meter of 8 per cent. nitric acid. This is done in the apparatus shown in Fig. 108. The bottom of the tube *B* is first filled with impure mercury and the nitric acid is added. The mercury is then poured through the funnel *A*, the stem of which is drawn out to a capillary and bent to an angle of 60° . This causes the mercury to take a zig-zag course as it flows slowly through the nitric acid. The dry mercury that first passes over into the flask *C* is impure and must be poured into the funnel and allowed to flow through the acid. In this way a fairly pure mercury

* *Z. anal. Chem.*, 2, 241 (1863). C. J. Moore (*Chem. Ztg.*, 1910, 735) has used a similar apparatus for purifying large quantities of mercury, but filters through buckskin before allowing it to fall through the acid.

is obtained which can be used as it is for most purposes. If the mercury is to be used for calibrating apparatus, it must be distilled.

For this purpose, Hulett's apparatus, shown in Fig. 109, may be used. The mercury is placed in the long-necked flask *K* which is connected with the receiver *V*. The flask is covered with a hood of asbestos paper and heated on the sand bath. Through the arm *a*, the receiver is connected with a suction pump and at

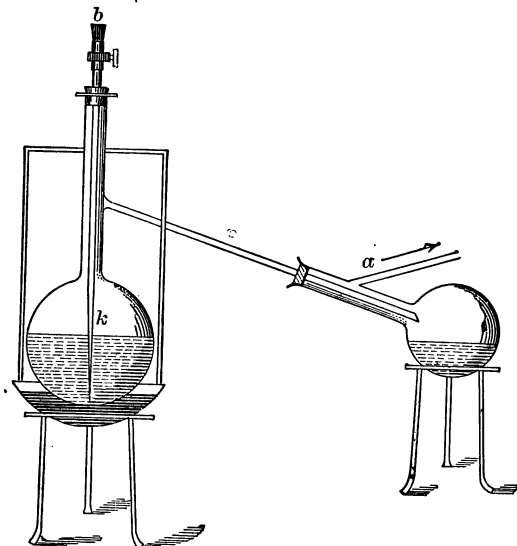

FIG. 109.

b a slow current of nitrogen (or carbon dioxide) which has been dried by passing over calcium chloride, is introduced into the flask through the long glass tube that ends in a capillary. The distillation is regulated so that the mercury condenses in the glass arm *c*, where it leaves the hood of asbestos paper. About 150–200 c.c. of mercury can be distilled in an hour with this apparatus. Frequently, especially when the nitrogen used contains a little oxygen, the distilled mercury is covered with a thin coating of oxide. This may be removed by filtration. To filter the mercury, the point of a paper filter is perforated several times with a needle, the filter placed in a funnel and the mercury poured

through. The pure metal runs through the holes in the paper while the impurity remains behind.

Subdivisions of Gas Analysis.

According to the manner of determining the amount of gas, we distinguish between:

1. *Absorption Methods.*
2. *Combustion Methods.*
3. *Volumetric Methods.*

In the case of an *absorption method* the mixture of gases is treated with a series of absorbents. The difference in the volumes of the gas before and after it has been acted upon by each absorbent represents the amount of gas absorbed. The absorption of the gas may take place in the measuring-tube itself, or, what is better, in separate absorption vessels.

In this way, the amount of carbon dioxide, heavy hydrocarbons (ethylene, benzene, acetylene, etc.), oxygen, and carbon monoxide may be determined in illuminating-gas, producer gas, water-gas, or Dowson gas.

After the constituents capable of absorption have been removed, a gas residue is left consisting of hydrogen, methane, and nitrogen; the two former constituents are determined by combustion, while the latter is always determined by subtracting the total amount of other gases found from 100 per cent.

For a *combustion analysis* the unabsorbed constituents of the gas mixture are mixed with air, or oxygen, in more than sufficient amount to ensure complete combustion, and burnt in a suitable apparatus; the amount of combustible gas is determined by measuring the contraction, the amount of carbon dioxide formed, and the excess of oxygen.

Finally, if the gas evolved by means of a chemical reaction is measured and from the volume of the latter the weight of the body producing it is calculated, we have made use of what is called a *gas-volumetric* method. (Cf. Determination of Carbonic and Nitric Acids, pp. 384 and 45^c).

DETERMINATION OF THE GASES.

Carbon Dioxide, CO₂. Mol. Wt. 44.

Density = 1.5290 * (Air = 1). Weight of 1 liter = 1.9767 gms.

Molar volume = 22.26 l.

Critical temperature = +31.5° C.

Carbon dioxide is absorbed to a considerable extent by water;
1 vol. water absorbs:

At 0° C.....	1.7967 c.c. CO ₂
“ 15° C.....	1.0003 “ “
“ 25° C.....	0.8843 “ “

or in general

$$\beta \dagger = 1.7967 - 0.07761 \times t + 0.0016424 \times t^2,$$

Absorbent.—Potassium Hydroxide Solution 1:2.

1 c.c. of caustic potash of the above strength will absorb at least 40 c.c. of CO₂. Sodium hydroxide solution is not used on account of the difficult solubility of sodium bicarbonate.

Small amounts of CO₂ may be absorbed by means of a definite amount of standardized Ba(OH)₂ solution, and the excess of the latter titrated with $\frac{N}{10}$ HCl, using phenolphthalein as indicator. (See p. 533).

* This number is the mean from the observations of Lord Rayleigh (1897) = 1.52909, Leduc (1898) = 1.52874, and Christie (1905) = 1.52930.

† β is called the absorption coefficient of the gas. This signifies the volume of gas, measured at 0° and 760 mm. pressure, which 1 c.c. of a liquid at t° will absorb when the pressure upon the surface of the liquid is 760 mm. If h c.c. of liquid, at t° and B mm. pressure, absorb V_t c.c. of the gas, then the absorption coefficient can be computed by the equation:

$$\beta = \frac{V_t}{h(1 + \alpha t)},$$

The Heavy Hydrocarbons.

Ethylene (Ethene), C_2H_4 ; Benzene, C_6H_6 ; Acetylene (Ethyne), C_2H_2 .

Ethylene, C_2H_4 . Mol. Wt. 28.03.

Density = 0.9739* (Air = 1). Weight of 1 liter = 1.2590 gms.

Molar volume = 22.27. Critical Temperature = +9° C.

Preparation of Ethylene.—One of the most satisfactory methods consists in treating an alcoholic solution of ethylene bromide with zinc dust †:

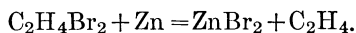

A round-bottomed flask of about 200 c.c. capacity, and having a short wide neck, is chosen for the experiment. In the neck is inserted a rubber stopper with three holes, carrying respectively a safety tube provided with mercury seal, a gas delivery tube, and a dropping funnel.

A sufficient amount of zinc dust, moistened with alcohol, is placed in the flask and gently heated at the start by placing the flask in a bath of warm water at about 50° C. A mixture of 1 part ethylene bromide and 20 parts absolute alcohol is placed in the dropping funnel, and allowed to flow slowly upon the zinc dust. The escaping gas is passed first through olive oil, to remove a little ethylene bromide which is carried over mechanically, then through caustic potash solution, and finally through water; it is collected over mercury, perhaps in the Drehschmidt pipette (Fig. 105, p. 743). The gas thus obtained is almost pure, particularly when the mixture of ethylene bromide and alcohol has stood for some time over anhydrous sodium carbonate to remove traces of hydrobromic acid.

A sample of the gas prepared by W. Misteli was found to con-

*M. Bretschger (Inaug. Dissert. Zürich, 1911) found the density of ethylene to be 0.9724, but M. Stahrfoos and P. A. Guye (Arch. soc. phys. et nat, 28 1909) found the value 0.9758. In the text the mean of these two values is used.

† Gladstone and Tribe, Berichte, 7, 364 (1874).

tain 98.84 per cent. of ethylene, 1.00 per cent. of hydrogen and 0.16 per cent. of nitrogen.

Absorption Coefficient for Water.

1 volume of water absorbs at

0° C.	0.256 c.c. C ₂ H ₄ ,
15° C.	0.161 " "
20 C.	0.149 " "

or in general,

$$\beta = 0.25629 - 0.00913631t + 0.000188108t^2.$$

Alcohol absorbs more ethylene; the general formula is

$$\beta = 3.594984 - 0.077162 \cdot t + 0.0006812 \cdot t^2.$$

Absorbents.—1. Fuming sulphuric acid* (with 20 to 25 per cent. free SO₃), 1 c.c. absorbs 8 c.c. of C₂H₄. 2. Bromine water.†

Ammoniacal cuprous chloride solution will also absorb ethylene.

By means of bromine, the ethylene is absorbed with the formation of ethylene bromide, C₂H₄Br₂. If the absorption is effected with a titrated bromine water, the amount absorbed can be determined by titrating the excess of bromine. This excellent method, proposed by Haber,‡ is at present the best known for the determination of ethylene in the presence of benzene. (See p. 818.)

Benzene, C₆H₆. Mol. Wt. 78.04.

78.04 gms. of benzene vapor occupy a volume of 22.391 liters under standard conditions.

Benzene is readily soluble in alcohol, ether, carbon bisulphide, caoutchouc, ethylene bromide, bromine, and fuming sulphuric acid.

* Ethionic acid, C₂H₆S₂O₇, is formed.

† Treadwell and Stokes, *Berichte*, 21 (1888), p. 3131.

‡ Haber and Oechelhäuser, *Berichte*, 29, p. 2700.

Absorbents.—Fuming sulphuric acid* and bromine water containing an excess of bromine.

Inasmuch as benzene is neither brominated nor oxidized by bromine at ordinary temperatures, it was difficult to understand why bromine water should absorb it quantitatively. In fact, Berthelot† and Cl. Winkler‡ disputed it, but the results of Treadwell and Stokes§ have recently been confirmed by Haber. He suggested that the absorption of benzene by bromine was of a purely physical nature, and M. Korbuly|| has shown that such is the case. Just as bromine can be removed from aqueous solution by shaking with benzene, so benzene can be removed by shaking with bromine, or even ethylene bromide and other like solvents.

By means of highly concentrated nitric acid (specific gravity 1.52) benzene is also absorbed; this solvent cannot be used in the analysis of gases containing carbon monoxide, for the latter is quantitatively oxidized to carbon dioxide by nitric acid of this strength, and is therefore removed with the benzene ¶ when the acid vapors are neutralized by caustic potash solution.

Behavior of Benzene to Water.

Benzene vapors are absorbed to a considerable extent by water and all aqueous salt solutions, a circumstance which must be considered when an exact gas analysis is to be made.

In order to determine how much benzene is absorbed by water, M. Korbuly performed the following experiments:

Different amounts of air containing 3.16 per cent. of benzene vapor were shaken in a Drehschmidt's pipette with the same amount of water (5 c.c.) until no more benzene was absorbed. He obtained the following results:

* Benzene sulphonic acid is formed, $C_6H_6SO_3$.

† *Compt. rend.*, **83**, p. 1255.

‡ *Zeitschr. f. anal. Chem.*, 1889, p. 281.

§ Treadwell and Stokes, *loc. cit.*

|| *Inaug. Dissertation*, Zurich, 1902.

¶ Treadwell and Stokes, *loc. cit.*

Experiment.	Gas Taken in c.c.	Per Cent. Benzene Present by Volume.	Amount of Benzene Absorbed at the End of Three Minutes.
1	58.92	3.16	1.28 c.c. = 2.17%
2	61.14	3.16	0.80 " = 1.31%
3	58.32	3.16	0.52 " = 0.89%
4	59.86	3.16	0.44 " = 0.73%
5	60.78	3.16	0.23 " = 0.46%
6	59.88	3.16	0.03 " = 0.01%
7	60.20	3.16	0.02 " = 0.00%

Potassium hydroxide behaves similarly.

In the analysis of a mixture of carbon dioxide and benzene, it is customary to first remove the carbon dioxide by means of potassium hydroxide solution and then the benzene with fuming sulphuric acid or bromine. It is evident, then, that both of the results obtained will be inaccurate if a fresh solution of potassium hydroxide is used for the absorption of the carbon dioxide, for this will absorb not only the whole of the carbon dioxide, but in many cases nearly all of the benzene. Accurate results may be obtained by using a solution of potassium hydroxide which has been saturated with benzene vapors.

Acetylene, C₂H₂. Mol. Wt. 26.02.

Density = 0.9134 * (Air = 1). Weight of one liter = 1,1808 gms.

Molar volume = 22.03 l. Critical temperature = +37° C.

Boiling Point = -80.6° C.

Acetylene is quite soluble in water; 1 volume of water at the ordinary temperature absorbs an equal volume of this gas. In amyl alcohol, chloroform, benzene, glacial acetic acid, and acetone it is much more soluble; thus 1 volume of acetone absorbs 31 volumes of acetylene.†

* M. Bretschger (Inaug. Dissert. Zurich, 1911) found the density of acetylene = 0.9157, whereas M. Stahrfoss and P. A. Guye (Arch. sci. phys. et nat., 28, 1909) found it = 0.9120. The mean of these two values is 0.91335.

† Hempel, Gasanalytische Methoden (1900), p. 206.

Preparation of Pure Acetylene.

(a) Method of M. Bretschger.*

The crude acetylene, prepared from calcium carbide, is passed through an acid solution of copper sulphate, then through aqueous chromic acid, caustic potash, and finally over slaked lime; it is then subjected to a fractional distillation. The gas is passed through a small bulb cooled by liquid air which causes the acetylene to solidify. By gentle warming, the acetylene is then evaporated and is caused to pass through calcium chloride tubes.

(b) Method of M. Stahrfoss and P. A. Guye.†

The impure acetylene, prepared from calcium carbide, is passed through a solution of potassium permanganate, then through caustic potash solution and finally over phosphorus pentoxide. It is frozen by means of liquid air and then fractionated.

The method of preparing acetylene by decomposing copper acetylde cannot be recommended, because the gas is then strongly contaminated with ethylene (C_2H_4) and vinyl chloride (C_2H_3Cl). Thus M. Bretschger ‡ found from 5 to 10 per cent. of ethylene in such gas.

Absorbents: Fuming sulphuric acid.§ By bromine water acetylene is absorbed extremely slowly in the cold, a fact which permits the titration of ethylene in the presence of acetylene (see page 821).

By means of ammoniacal cuprous chloride, acetylene is absorbed and forms red copper acetylde ($Cu_2C_2H_2O$). This reaction is so characteristic that it is used for the

Qualitative Detection of Acetylene

in gas mixtures. This test is best performed by the method of L. Ilosvay von Nagy Ilosva.||

* *Loc. cit.*

† Private Communication from Professor Guye.

‡ *Loc. cit.*

§ $C_2H_5SO_4$ is formed.

|| *Berichte*, **32** (1899), p. 2698.

Preparation of the Reagent.—One gram of copper nitrate (chloride or sulphate) is placed in a 50-c.c. measuring-flask and dissolved in a little water. To the solution 4 c.c. of concentrated ammonia (20–21 per cent. NH_3) and 3 gms. of hydroxylamine hydrochloride are added, and the liquid is shaken until it becomes colorless, when it is immediately diluted with water up to the mark.

The Qualitative Test.—A few cubic centimeters of the reagent are placed in a 500-c.c. glass-stoppered cylinder and the gas to be tested for acetylene (illuminating-gas) is passed over it until the color of the reagent becomes pink. The cylinder is then stoppered and its contents thoroughly shaken. If acetylene is present, a beautiful red precipitate is immediately formed. Another method of making the test is to pass the gas through a small bulb-tube containing glass-wool moistened with the reagent.

Remark.—If the reagent is placed under petroleum it can be kept for about one week, but if copper wire is added to the solution, it can be kept for a much longer time, as L. Pollak has shown. Such a solution gave a distinct reaction after it had been kept for one year, but the precipitate obtained, instead of being a bright red, was more the color of sealing-wax. The solution is much less permanent when it is prepared from the chloride or sulphate, even when copper is added to it. Without the copper, the chloride would give no reaction after being a week old, and with the addition of copper it was spoiled at the end of two weeks. The sulphate behaved about the same.

Separation of the Heavy Hydrocarbons from One Another.

It has been attempted repeatedly to separate ethylene from benzene, but usually in vain. The separation as proposed by Berthelot, of absorbing the ethylene with bromine water and afterwards removing the benzene by means of concentrated nitric acid, is erroneous in every respect.* The method of Harbeck and Lunge † is correct in principle but very tedious, and the original modification of Pfeiffer ‡ always gives too high results.

* Treadwell and Stokes, *loc. cit.*

† *Zeit. f. anal. Chem.*, XVI (1898), p. 26.

‡ *J. f. Gasbeleuchtung und Wasserversorgung*, 1899, p. 697, and *Berichte*, 29, p. 2709.

Recently Pfeiffer * has improved his method so that it gives the same results as that of Harbeck and Lunge.

Haber and Oechelhäuser,† on the other hand, have devised a method which is accurate and to be recommended.

Principle.—In one portion of the gas, the sum of the ethylene and benzene is determined by absorption with bromine water or fuming sulphuric acid, while in a second portion the gases are absorbed in titrated bromine water, and the excess of the latter is determined iodimetrically. From the amount of bromine required the ethylene is calculated:

$$1 \text{ c.c. } \frac{N}{10} \text{ I} = 1.114 \text{ c.c. } \text{C}_2\text{H}_4 \text{ at } 0^\circ \text{ C. and } 760 \text{ mm. pressure.}$$

As this analysis is performed in the Bunte burette, it will not be described in detail until we have become acquainted with this important form of apparatus. (See p. 798.)

Oxygen, O=16. Mol. Wt. 32.

Density=1.1053 (Air=1). Weight of 1 liter=1.4289 gms.

Molar volume=22.39 l. Critical temperature=−119° C.

Oxygen is only slightly soluble in water; according to the experiments of L. W. Winkler,‡ one liter of water at 60 mm. pressure will absorb the following quantities of air:

ABSORPTION COEFFICIENTS OF ATMOSPHERIC AIR.

Temperature.	(1000 c.c. absorbed)		
	Oxygen.	Nitrogen.	Air.
0°.....	10.24 c.c.	18.57 c.c.	28.81 c.c.
5°.....	8.98 "	16.45 "	25.43 "
10°.....	7.97 "	14.67 "	22.64 "
15°.....	7.16 "	13.29 "	20.45 "
20°.....	6.50 "	12.19 "	18.69 "
25°.....	5.93 "	11.31 "	17.24 "
30°.....	5.47 "	10.59 "	16.06 "
35°.....	5.11 "	9.92 "	15.03 "
40°.....	4.83 "	9.35 "	14.18 "
45°.....	4.58 "	8.93 "	13.51 "
50°.....	4.38 "	8.59 "	12.97 "
55°.....	4.22 "	8.31 "	12.53 "

* See Chem. Ztg., 1904 (884).

† J. f. Gasbeleuchtung und Wasserversorgung, 1896, p. 804, and Berichte, 29, p. 2700.

‡ Berichte, 34, 1410 (1901).

From these data, the absorption coefficient of pure oxygen for water at 0 to 55° can be computed.

ABSORPTION COEFFICIENTS OF OXYGEN FOR WATER.

Temperature.	β	Temperature.	β
0°.....	0.04890	30°.....	0.02608
5°.....	0.04286	35°.....	0.02440
10°.....	0.03802	40°.....	0.02306
15°.....	0.03415	45°.....	0.02187
20°.....	0.03102	50°.....	0.02090
25°.....	0.02831	55°.....	0.02012

Oxygen can be determined by combustion or by absorption.

The Determination of Oxygen by Combustion.

The determination of oxygen by combustion may be effected by exploding it with hydrogen (Bunsen) or by conducting a mixture of the two gases through a glowing platinum capillary (Drehschmidt), exactly as in the determination of carbon monoxide (cf. p. 765). In both cases the combustion takes place in accordance with the equation:

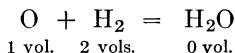

Three volumes of gas, therefore, disappear for each volume of oxygen present. If the contraction resulting from the combustion of a mixture of oxygen and an excess of hydrogen is designated by V_c , then the amount of oxygen present = $\frac{1}{3}V_c$.

The Determination of Oxygen by Absorption.

The absorbents of oxygen are:

1. *Alkaline Pyrogallol Solution (Liebig).*

One volume of a 22 per cent. aqueous solution of pyrogallol is mixed with five or six times as much potassium hydroxide solution (3:2). 1 c.c. of this solution absorbs 12 c.c. of oxygen.

At a temperature of 15° C., or higher, the absorption takes place quickly; the oxygen in 100 c.c. of air will be absorbed in three minutes or less.

At lower temperatures the absorption takes place less readily and at 0° C. the above quantity of oxygen cannot be absorbed completely in half an hour.

A pyrogallol solution of the above concentration will not evolve carbon monoxide during the absorption.

2. Phosphorus (*Lindemann*).

The absorption of oxygen by means of phosphorus takes place by simply allowing the gas containing the oxygen to remain over moist phosphorus. The formation of white clouds indicates the presence of oxygen, and their disappearance shows that the absorption is complete. A temperature of 15 to 20° C. is best suited for the absorption.

The oxygen is completely absorbed at the end of three minutes from 100 c.c. of air at this temperature. At lower temperatures the absorption requires more time and at 0° more than an hour is necessary.

If the gas contains more than 60 per cent. of oxygen, moist phosphorus will absorb none of it at the ordinary atmospheric pressures. In this case the gas must be diluted with nitrogen or hydrogen until a mixture is obtained containing less than 60 per cent. oxygen, or the gas must be allowed to act upon the moist phosphorus under diminished pressure. In the latter case, however, the phosphorus easily becomes heated enough to melt it.

Further, oxygen is not absorbed by moist phosphorus if the gas contains traces of heavy hydrocarbons, ethereal oils, alcohol, or ammonia. According to Hempel* 0.04 per cent. of ethylene, and according to Haber † 0.17 per cent., suffices to prevent completely the absorption of oxygen.

* Gasanalytische Methoden.

† Experimental-Untersuchung über Zersetzungen und Verbrennungen von Kohlenwasserstoffen, Habilitationsschrift, Munich, 1896.

3. *Chromous Chloride.*

Consult the paper by Otto von der Phordten, *Annal. Chem. Phys.* **228**, 112.

4. *Copper.*

The gas is either conducted over glowing copper, or it is introduced into a Hempel pipette containing rolls of copper gauze and an ammoniacal solution of ammonium carbonate.

5. *Sodium Hydrosulphite,* Na₂S₂O₄ (Franzen †).*

An alkaline solution of sodium hydrosulphite, which can now be obtained commercially at a low price, is an excellent absorbent for oxygen. The reagent may be prepared for use in the Hempel pipette by dissolving 50 gms. of the salt in 250 c.c. water and 40 c.c. caustic potash solution (500 KOH:700H₂O). For absorption in the Bunte burette, the above solution is too concentrated; in this case 10 gms. hydrosulphite in 50 c.c. water plus 50 c.c. of 10 per cent. caustic soda, may be used.

The absorption takes place in accordance with the equation:

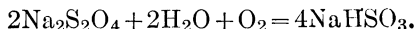

Sodium hydrosulphite has the advantage over all other absorbents that the absorption is always complete at the end of five minutes.

Determination of Absorbed Oxygen in Water. Method of L. W. Winkler.‡

1000 c.c. $\frac{N}{10}$ Na₂S₂O₃ solution = $\frac{O}{20} = \frac{16}{20} = 0.8$ gm. or 559.8 c.c. oxygen at 0° and 760 m.m pressure.

Principle.—If water containing dissolved oxygen be heated in a closed vessel with manganese hydroxide, the latter is oxidized to manganous acid according to the following equation:

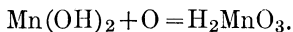

* This is really sodium *hyposulphite*, although sodium *thiosulphate*, Na₂S₂O₃, is commonly called "hyposulphite."

† *Berichte*, **39**, 2069 (1896).

‡ *Ibid*, **21** (1888), p. 2843.

The amount of oxygen taken up is determined iodimetrically by adding hydrochloric acid and potassium iodide to the manganoous acid and titrating the liberated iodine,

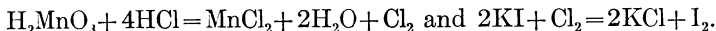

Hence 1 gm.-at. I = 8 gms. = 5597.8 c.c. oxygen at 0° C. and 760 mm. pressure.

Reagents Required.—1. *An approximately 4N·MnCl₂ solution* obtained by dissolving 400 gms. of MnCl₂ + 4H₂O in water and diluting to 1000 c.c. The manganese chloride must be free from iron.

2. *Sodium Hydroxide Solution Containing Potassium Iodide.*—On account of the nitrite usually present in commercial sodium hydroxide, the alkali solution is prepared from sodium carbonate and calcium hydroxide. The clear liquid is siphoned off and concentrated in a silver dish until its specific gravity is 1.35. In 100 c.c. of this solution, 10 gms. of potassium iodide are dissolved.

A portion of the alkaline potassium iodide solution on being acidified with hydrochloric acid should not immediately turn starch paste blue, and, furthermore, large amounts of carbonate must not be present.

3. $\frac{\text{N}}{10}$ *Sodium Thiosulphate Solution.*

Procedure.—A glass-stoppered flask of about 250-c.c. capacity is taken and its exact capacity is determined by weighing it first empty and then filled with water at 17.5° C. If the water to be analyzed is saturated with air, it is simply poured into the flask, otherwise the water is conducted through it for ten minutes. Then, by means of a pipette reaching to the bottom of the flask, 1 c.c. of the alkaline potassium iodide solution is introduced and immediately afterwards 1 c.c. of the manganese chloride solution. The flask is closed, shaken, and allowed to stand until the precipitate has settled. Then, by means of the long-stemmed pipette, about 3 c.c. of concentrated hydrochloric acid are introduced and the contents of the flask once more shaken. The precipitate dissolves readily with liberation of iodide and the latter is titrated with sodium thiosulphate in the usual way.

Remark.—The results obtained by this method agree closely with those obtained by boiling the water as described on p. 739.

Carbon Monoxide, CO. Mol. Wt. 28.

Density = 0.96702 (Air = 1). Weight of 1 liter 1.2502 gms.
 Molar Volume = 22.397 liters. Critical temperature = -136° C.

Preparation.—Some concentrated sulphuric acid is heated in a fractionating flask to a temperature of 140° to 160° C. upon an oil bath, and formic acid (sp. gr. 1.2) is allowed to drop into it:

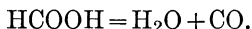

In order to free the escaping gas from water and acid vapors, it is conducted first through a Liebig condenser, which leads to an empty flask to receive the condensed water, and from thence into a concentrated caustic potash solution.

This method * yields about 60 liters of carbon monoxide in half an hour, using about 500 c.c. of concentrated sulphuric acid. The method of Wade and Panting, † according to which very pure carbon monoxide can be prepared by allowing concentrated sulphuric acid to drop upon potassium cyanide, is not, according to Allner, a suitable process for preparing large quantities of the gas; because considerable potassium cyanide becomes enveloped in pyrosulphuric acid during the reaction, so that there is considerable danger involved in working with the residues.

By the action of hot concentrated sulphuric acid upon oxalic acid, it is very easy to prepare a mixture of equal volumes carbon monoxide and carbon dioxide; on account of the large amount of the latter, however, this method is less satisfactory than that of Allner.

The gas is only very slightly soluble in water;

ABSORPTION COEFFICIENTS OF CARBON MONOXIDE FOR WATER. ‡

Temperature.	β	Temperature.	β
0°.....	0.03537	30°.....	0.01998
5°.....	0.03149	35°.....	0.01877
10°.....	0.02816	40°.....	0.01775
15°.....	0.02543	45°.....	0.01690
20°.....	0.02319	50°.....	0.01615
25°.....	0.02142	55°.....	0.01548

* W. Allner, Inorg. Dissert. Karlsruhe, 1905.

† J. Chem. Soc., **73**, 255.

‡ L. W. Winkler, Berichte, **34**, 1414 (1901).

In alcohol the gas is about ten times more soluble than it is in water.

Its determination is effected either by absorption or by combustion.

Absorbents.—*Ammoniacal Cuprous Chloride.* 200 gms. of commercial cuprous chloride are shaken in a closed flask with a solution of ammonium chloride (250 gms. in 750 c.c. water), and to every three volumes of this mixture 1 vol. of ammonia, specific gravity 0.91, is added. In order that the solution may remain active, a spiral of copper wire is introduced into the flask long enough to reach from the bottom up to the stopper.

1 c.c. of this solution will absorb 16 c.c. of carbon monoxide.

Formerly it was the almost universal custom to absorb this gas by means of a *hydrochloric acid* solution of cuprous chloride, but to-day this is not done on account of the following reasons. The absorption of carbon monoxide by means of cuprous chloride takes place according to the following equation:

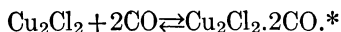

The compound $\text{Cu}_2\text{Cl}_2 \cdot 2\text{CO}$ is extremely unstable and can only be formed when there is a certain pressure exerted by the carbon monoxide, so that when the acid solution is used the absorption will never be quantitative. Further, if a gas free from carbon monoxide (nitrogen or hydrogen) is shaken with such a solution after it has been used several times, a part of the $\text{Cu}_2\text{Cl}_2 \cdot 2\text{CO}$ in solution will be decomposed according to the above equation in the direction of right to left, until the partial pressure of the carbon monoxide set free is sufficient to restore equilibrium. Consequently the volume of the gas will appear greater after it has been treated with the cuprous chloride solution than it was originally.

When an *ammoniacal* cuprous chloride solution is employed, the absorption of the carbon monoxide is almost quantitative, but after such a solution has been used repeatedly it will readily give up some of the gas, although not so readily as is the case of the solution of cuprous chloride in hydrochloric acid or calcium chlo-

* The compound has been isolated in the solid state, according to W. A. Jones (Am. Chem. J., 22, 287) its formula is $\text{CuCl}_2 \cdot 2\text{CO} \cdot 4\text{H}_2\text{O}$, but according to the experiments of C. v. Girsowald in the author's laboratory, the formula is $\text{Cu}_2\text{Cl}_2 \cdot 2\text{CO} \cdot 2\text{H}_2\text{O}$.

ride.* It is advisable, therefore, to adopt the suggestion of Drehschmidt, and first absorb the greater part of the gas by means of an old solution of cuprous chloride, afterwards removing the last traces by means of a freshly-prepared solution, or one which has been used but a few times.

Besides carbon monoxide, the ammoniacal cuprous chloride solution will absorb acetylene, ethylene, etc., so that these gases must be removed previously by means of fuming sulphuric acid or bromine water.

By long shaking with concentrated nitric acid (specific gravity 1.5), carbon monoxide is completely oxidized to carbon dioxide, and the latter can be removed by treatment with potassium hydroxide solution.†

Determination of Carbon Monoxide by Combustion with Air or Oxygen.

The following reaction shows how carbon monoxide may be determined by combustion:

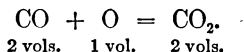

From the reaction we can make the following deductions:

1. The difference in the volume of the gas mixture before and after the combustion is for 2 vols. CO; $3 - 2 = 1$ and for 1 vol. $\text{CO} = \frac{1}{2}$. This difference is designated as the contraction. *The contraction caused by the combustion of carbon monoxide is, therefore, equal to half the original volume of CO.*

2. *The volume of the carbon dioxide formed is equal to the volume of the carbon monoxide originally present.* If, then, the carbon dioxide is determined by absorption with caustic potash, the volume of the carbon monoxide is at once obtained, provided no other combustible gas containing carbon is present at the same time.

* Cuprous chloride is soluble in a concentrated solution of calcium chloride. 1 c.c. of this solution absorbs 12 to 15 c.c. of CO.

† Treadwell and Stokes, *Berichte*, 21, p. 3131.

3. For the combustion of 2 vols. of CO, 1 vol. of oxygen is necessary, and consequently *the amount of oxygen consumed is equal to half the volume of the carbon monoxide.*

Methods of Effecting the Combustion.

The combustion of the carbon monoxide can be carried out in several different ways:

1. By explosion.
2. By conducting the gas over glowing palladium or platinum.
3. By conducting the gas over copper oxide.

1. *Combustion by Explosion.*—The gas is mixed with a sufficient amount of air in a measuring vessel, such as is shown in Fig. 105, and the latter is connected by means of the capillary *E* with the Hempel's explosion pipette shown in Fig. 110. The gas is completely driven over into the latter

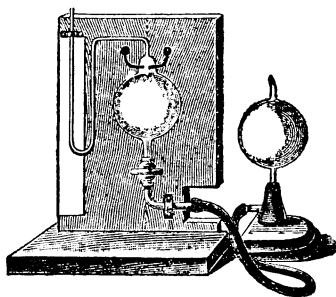

FIG. 110.

so that the capillary is entirely filled with mercury, the stop-cocks of the capillary and of the explosion pipette are both closed, and an electric spark is made to pass between the two platinum points which are fused into the glass walls of the pipette; this immediately causes an explosion to take place. Afterwards the gas is once more driven

back into the measuring burette, and its volume again determined. The difference in volume before and after the explosion represents the contraction.

This most excellent method can in some cases lead to erroneous results. In practice, it is almost always a question of determining the amount of combustible gas in a mixture containing nitrogen obtained after treatment with the different absorbents. If the amount of combustible gas present is too small in proportion to the amount of non-combustible gas, there will be no combustion whatsoever; while on the other hand, if this relation is too large, a part of the nitrogen will be burnt to nitric acid (hydrogen is usually

present). According to Bunsen, the combustion is complete when 30 parts of combustible gas are present for each 100 parts of non-combustible gas. Consequently, if the explosion method is to be used for the analysis, the approximate composition of the gas must be known.

2. *Combustion by Conducting the Gas over Glowing Palladium.*—This is the most certain of all methods for effecting the combustion, because it is entirely independent of the proportion of combustible gas present,* and there is no danger of any of the nitrogen being oxidized. The combustion is best effected, as proposed by Drehschmidt, by passing the gas through a thick-walled platinum capillary tube containing three palladium wires. The platinum capillary (Fig. 105, V) is placed between the gas burette and the Drehschmidt pipette S (Fig. 105), and it is heated by means of the non-luminous flame of a Teclu burner. The gas is repeatedly passed through the glowing capillary until there is no further diminution in volume, showing the combustion to be complete. There is no danger to be feared from explosions even when pure detonating gas is passed through the platinum tube, and by this method CO, H, and CH₄ are completely oxidized. In the analysis of gases containing only small amounts of the above gases (e.g. exhaust gases from gas-motors) the so-called fractional combustion is employed. By this means either hydrogen and carbon monoxide are oxidized while methane is not, or carbon monoxide is alone burned.

Fractional Combustion.—If, according to Haber,† an absolutely dry gas mixture, consisting of considerable nitrogen and oxygen with little carbon monoxide, hydrogen, and methane, is slowly conducted (at the rate of about 700–800 c.c. per hour) through a glass U tube 3 mm. in diameter which contains a palladium wire 55 cm. long, folded into three lengths of about 18 cm., then if the temperature of boiling sulphur is maintained, the hydrogen and carbon monoxide will be completely burned, while methane will escape from the tube

* It is only necessary to make sure that a large excess of oxygen is present (cf. Hempel, *Zeitschr. f. anorg. Chem.*, XXXI (1902), p. 447.

† *Loc. cit.*

in an unchanged condition. By connecting the U tube with a weighed calcium chloride tube and then with two weighed soda-lime tubes (see p. 380) the increase in the weight of the former will show the amount of water formed from the hydrogen, and the gain in weight shown by the soda-lime tubes corresponds to the amount of carbon dioxide formed from the carbon monoxide. If, after passing through the soda-lime tubes, the gas is passed through a combustion-tube filled with platinized asbestos, or copper oxide, which is heated to a dark-red heat, the methane is quantitatively burned to water and carbon dioxide; the former is absorbed in a calcium chloride tube and the latter in two soda-lime tubes, all three tubes being weighed before the gas is passed through them. In this way a check is obtained upon the accuracy of the determination, for the proportion of carbon to hydrogen found should be 1:4.

The combustion of carbon monoxide alone from a mixture of this gas with hydrogen, methane, and air can be effected satisfactorily as follows:

After the gas has been freed from CO_2 , unsaturated hydrocarbons, and aqueous vapor, it is conducted through a U tube * containing 60–70 gms. of pure iodine pentoxide † heated to 160°C .; by this means the carbon monoxide is alone oxidized with liberation of iodine according to the equation

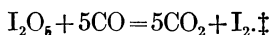

If the gas is now conducted through two Péligot tubes containing potassium iodide solution, the iodine will be absorbed and can be titrated at the end of the experiment with $\frac{N}{10}$ sodium thiosulphate solution.

1 c.c. $\frac{N}{2}$ $\text{Na}_2\text{S}_2\text{O}_3$ solution corresponds to 5.6 c.c. CO, measured under standard conditions.

* The U tube is heated in a small paraffin bath.

† Iodine pentoxide is prepared by heating iodic acid in a current of dry air at 180° until the water is completely removed.

‡ Nieloux, *Compt. rend.*, 126, p. 746, and Kinnicutt, *Journ. of the Am. Chem. Soc.*, XXII, p. 14.

If, after the carbon dioxide and water have once more been removed from the gas, it is passed through a combustion-tube half filled with copper oxide and half with platinized asbestos, both heated to dark redness, the hydrogen and methane will be completely burned to water and carbon dioxide, which can be absorbed and weighed as before. From the amounts of each, the hydrogen and methane present in the gas can be calculated.

Qualitative Detection of Traces of Carbon Monoxide in the Air.

If blood be diluted with water until the solution shows only a slight red color, it will give a characteristic absorption spectrum; two dark absorption bands appear between the *D* and *E* lines. If to this dilute blood solution a few drops of a concentrated, freshly-prepared ammonium sulphide are added, the dark bands disappear, and instead a single broad band will appear at a place between the positions of the previous bands. Blood containing carbon monoxide behaves quite differently. When the latter gas is present, the blood takes on a rose color and the solution gives almost the same absorption spectrum as pure blood (the bands shift slightly toward the violet) but in this case *the two bands do not disappear on the addition of ammonium sulphide.*

To detect traces of carbon monoxide in the air, Vogel directs that a 100-c.c. bottle, filled with water, be emptied in the room containing the gas, and that 2 to 3 c.c. of blood, highly diluted with water, and showing only a very faint red color (although still giving the blood spectrum in a column as thick as a test-tube) be poured into the bottle and shaken for some minutes. To the solution a few drops of ammonium sulphide solution are added and the liquid is examined by means of the spectroscope. If the two bands are now visible, carbon monoxide is present. According to Vogel as little as 0.25 per cent. of CO can be detected in this way.

Hempel has improved this method to a marked degree. He found that it was not possible to completely remove small amounts of carbon monoxide by shaking with the dilute solution

of blood, and furthermore concentrated blood solutions could not be used because they foam so much. By using a living animal, its lungs furnish a better means of absorption, for the gas then comes in contact with undiluted blood. A mouse is placed between two funnels which are joined together by means of a broad band of thin rubber and the gas to be tested is passed through the funnels at a speed of ten liters per hour. At the end of two or three hours the mouse is killed by immersing the funnels in water and a few drops of its blood are taken from the region near the heart. In this way Hempel was able to detect with certainty as little as 0.032 per cent. CO. With such small amounts of CO the live mouse showed no symptoms of poisoning; this was first apparent when 0.06 per cent. of the gas was present. In the latter case after half an hour the mouse breathed with difficulty and lay exhausted on its side.

Potain and Drouin detect small amounts of carbon monoxide by passing the gas through a dilute solution of palladous chloride, whereby metallic palladium is precipitated:

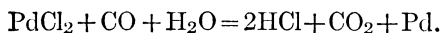

The solution is decolorized, or turns a pale gray, when large amounts of CO are present, but appears a light yellow in color when only traces are present.

In order to estimate better the decrease in color, Potain and Drouin filter off the deposited palladium and compare the color of the filtrate.

For the detection of small amounts of carbon monoxide, C. Winkler recommends a method which, as the author has found, will often lead to error. According to Winkler, the gas to be tested is conducted through a solution of cuprous chloride in a saturated solution of sodium chloride, afterwards diluting with four to five times as much water, causing the precipitation of snow-white cuprous chloride. If this turbid solution is treated with a drop of sodium palladous chloride, a black precipitate of metallic palladium is obtained. Unfortunately, however, the palladium is often precipitated even in the absence of a trace of carbon

monoxide; for cuprous chloride itself will readily reduce salts of palladium.

It is true, on the other hand, that at a definite concentration the reduction of the palladous chloride is only effected by means of carbon monoxide, but it is difficult to always obtain the right conditions, and herein lies the inaccuracy of the method. If the solution be too concentrated with respect to sodium chloride, even large amounts of carbon monoxide will fail to precipitate a trace of palladium, because in that case the solution contains not only copper but also palladium in the form of complex sodium salts:

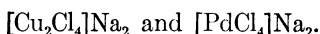

The sodium palladous chloride is not reduced by carbon monoxide and there is even less likelihood of the two sodium salts acting upon one another. If the solution be diluted with water, both salts break down according to the equations

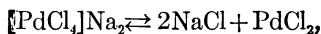
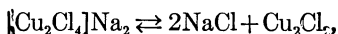

and only when the palladium is in the ionic condition is it capable of entering into the reaction. The fact that the reduction of the palladous chloride is effected by means of CO at a concentration at which Cu_2Cl_2 is incapable of causing any reduction is easy to understand, for the gas, CO, comes in contact more readily with a sufficient number of palladium ions than does the difficultly soluble cuprous chloride.

Hydrogen, H. Mol. Wt. 2.016.

Density = 0.06960 * (Air = 1). Weight of 1 liter = 0.089978 gm.

Molar volume = 22.405 l. Critical temperature = -238°C .

Hydrogen is practically insoluble in water.

* Lord Rayleigh, Proc. Roy. Soc., 53, 1134 (1893).

ABSORPTION COEFFICIENTS OF HYDROGEN FOR WATER.*

Temperature.	β	Temperature.	β
0°.....	0.02148	30°.....	0.01699
5°.....	0.02044	35°.....	0.01666
10°.....	0.01955	40°.....	0.01644
15°.....	0.01883	45°.....	0.01624
20°.....	0.01819	50°.....	0.01608
25°.....	0.01754	55°.....	0.01604

The usual way for determining this gas by absorption is by means of metallic palladium,† but in the majority of cases it is determined by combustion with oxygen and observing the contraction:

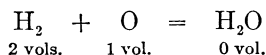

It is evident that by the combustion of two volumes of hydrogen, three volumes of gas will disappear (the water formed occupies a negligible volume). The contraction, therefore, is equal to $\frac{3}{2}$ the volume of the hydrogen consumed. If the contraction is denoted by V_C and the volume of the hydrogen by V_H , then

$$V_C = \frac{3}{2} V_H,$$

and consequently

$$V_H = \frac{2}{3} V_C.$$

In many cases the weight of the water formed is determined by absorbing the latter in weighed calcium chloride tubes, and from the gain in weight the volume of hydrogen is computed as follows:

$$18.02:22,405 = p:x,$$

$$x = \frac{22,405}{18.02} \times p = 1243.6 \times p \text{ c.c. hydrogen under standard conditions.}$$

* L. W. Winkler, *Berichte*, **24**, 99 (1891).

† The absorption can also be accomplished very satisfactorily by means of a one per cent. solution of palladous chloride. Campbell and Hart, *Am. Chem. J.*, **18**, 294.—[Translator.]

Combustion of Hydrogen, according to Cl. Winkler.

The following method is employed frequently in *technical* analyses for the separation of hydrogen from methane.

A mixture of hydrogen and air is conducted over gently-ignited palladium-asbestos, by which means the hydrogen is quantitatively burned to water and the methane is not affected. Fig. 111

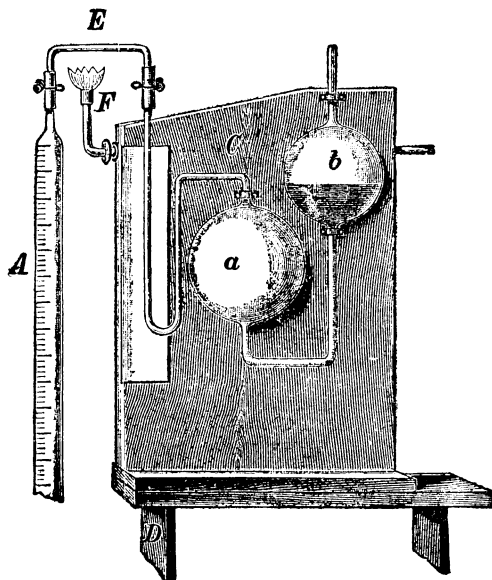

FIG. 111.

represents the apparatus required. *A* is the eudiometer and is connected by means of the capillary *E*, in which is found a short fibre of palladium-asbestos, with a Hempel pipette filled with water.

The capillary, *E*, is heated by means of the small flame *F*, at the place where the palladium-asbestos rests, to a temperature of about 300 to 400°, but not hot enough to soften the glass. After the gas, which is mixed with air,* has been passed back and forth

* If oxygen is used instead of air, some of the methane is sure to be oxidized. Cf. O. Brunck, *Zeit. f. angew. Chem.*, 1903, p. 195.

through the capillary three times, the combustion is complete. If the above-specified temperature is not exceeded, no trace of methane will be burned and the hydrogen determination will be accurate. It is, however, difficult to regulate this temperature closely enough to prevent the combustion of some methane unless, as recommended by Haber, the tube is heated by means of sulphur vapor; the results are usually from 0.5 to 1 per cent. too high.

Preparation of Palladium-asbestos.—Three gms. of sodium palladous chloride are dissolved in as little water as possible, 3 c.c. of a cold saturated solution of sodium formate are added and enough sodium carbonate solution to make the solution alkaline. Then about 1 gm. of soft, long-fibred asbestos is added, which sucks up the whole of the liquid, and the mixture is dried on the water bath; by this means finely-divided palladium is deposited uniformly through the asbestos:

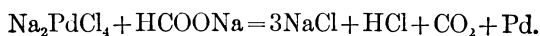

The hydrochloric acid formed by the above reaction is neutralized by the sodium carbonate. In acid solutions formic acid hardly reduces palladous chloride at all.

After the asbestos has thoroughly dried, the mass is softened with hot water, placed in a funnel and washed with hot water until the soluble salt is completely removed. It is then dried once more and preserved in a well-stoppered bottle.

The palladium-asbestos fibre is introduced into the capillary tube as follows: The fibre is rolled between the fingers to a little round wad, the latter is placed in the opening of the unbent capillary tubing and by gentle tapping upon the table it is made to pass along to the centre of the tube. The latter is then bent as shown in the figure.

Remark.—Inasmuch as the palladium-asbestos is likely to become shoved into the capillary, it is perhaps more satisfactory to use instead a palladium wire which is wound into a spiral.*

* Private communication from Dr. Leutold of Hamburg.

Methane, CH₄. Mol. Wt. 16.03.

Density = 0.55297. (Air = 1.) Weight of 1 liter = 0.71488 gms.

Molar volume = 22.43 l. Critical temperature = -82° C.

Preparation.—Methane is conveniently prepared by a process analogous to that used in making ethylene * (cf. p. 751). A mixture of equal parts methyl iodide and alcohol (sp. gr. 0.805) is allowed to act upon a zinc-copper couple which has been washed with alcohol.

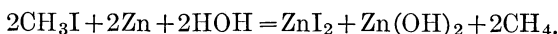

The zinc-copper couple is obtained by pouring a 2 per cent. copper sulphate solution four times over granulated zinc, then washing with water, and finally with alcohol.

By allowing the mixture of methyl iodide and alcohol to drop upon the copper-coated zinc, a steady stream of methane is obtained at the ordinary temperature. The gas is purified by shaking it with fuming sulphuric acid, and then with caustic potash solution. It then contains nearly 99 per cent of CH₄ and about 1 per cent. of nitrogen.

Methane, also called marsh-gas or fire damp, is only slightly soluble in water.

ABSORPTION COEFFICIENTS OF METHANE FOR WATER.†

Temperature.	β	Temperature.	β
0°.....	0.05563	30°.....	0.02762
5°.....	0.04805	35°.....	0.02546
10°.....	0.04177	40°.....	0.02369
15°.....	0.03690	45°.....	0.02238
20°.....	0.03308	50°.....	0.02134
25°.....	0.03006	55°.....	0.02038

In alcohol, the gas is about ten times as soluble as it is in water. Inasmuch as no satisfactory absorbent for methane is known, it is always determined by combustion.

From the equation representing the combustion,

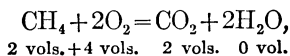

we can make the following deductions:

1. *Contraction.*—The contraction caused by the combustion of methane is equal to twice its original volume.

2. *Carbon Dioxide.*—By the combustion of methane an equal volume of carbon dioxide is produced.

3. *Oxygen Consumed.*—For the combustion of one volume of methane two volumes of oxygen are necessary.

* Gladstone and Tribe, J. Chem. Soc., 45, 154.

† L. W. Winkler, Berichte, 34, 1419 (1901).

ANALYSIS OF ILLUMINATING AND PRODUCER GASES.

The analysis of all such gases is best performed either by the method of Hempel* or that of Drehschmidt.†

Hempel's Method.

Hempel's apparatus is shown in Fig. 105, p. 743. It consists of a eudiometer, *W*, divided into $\frac{1}{4}$ c.c. and connected by means of rubber tubing with the levelling-bulb *K*. The eudiometer is also connected with the compensation-tube *D* and the latter is connected with a manometer *C*; both the tubes *W* and *D* are surrounded by a cylinder containing water.

Calibration of the Apparatus.—First of all the manometer-tube is filled with mercury by raising the levelling-bulb *K* with the stop-cock *p* in the position shown in Fig. 105, so that there is an open connection between *W* and *c*; the mercury is allowed to pass over into *C* until the mark *mm* is reached. The volume of the manometer-tube from the mark *m* to the point *a* (Fig. 105) is now determined as follows:

By carefully lowering the bulb *K* the mercury is drawn over into *C* exactly to the point *a* when the stop-cock *p* is closed. A little air is allowed to enter into the eudiometer through the right-hand capillary tube above *p* (the tube *E* should be withdrawn as in Fig. 112), the levelling-bulb *K* is placed upon a solid support at about the same height as the mercury in *W*, and with the stop-cock *p* still open the position of the mercury in *W* is read. The stop-cock is closed, *K* is raised a little and *p* is turned to the position shown in Fig. 105. By raising *K* still higher, the air is driven over into the manometer-tube *C* until the mercury has exactly reached the mark *m*, when the stop-cock *A* (Fig. 105) is closed. The exact position of the mercury is then adjusted by turning the stop-cock *p* one way or the other, and the position of the mercury in *W* is once more read. The difference between the

* Gasanalytische Methoden (1900), p. 48 ff.

† Berichte, 21, p. 3242 (1888).

two readings represents the volume of the tube between the marks *m* and *a*, an amount which must be added to all subsequent readings.

A drop of water is now introduced at *c*, by means of a fine

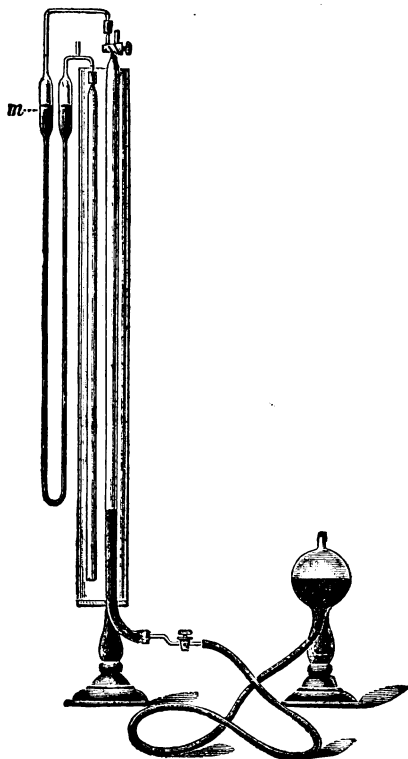

FIG. 112.

pipette, into the compensation-tube *D* and the end of the tube *c* is either fused together, or closed with a cork stopper and made air-tight with sealing wax.

Procedure for the Analysis.—If the analysis is to be carried out on the spot, a large sample of the gas is collected in a Drehschmidt pipette (Fig. 105 *S*). To accomplish this the capillary tube *E'* is connected by means of rubber tubing with the source

of the gas, and the stop-cock M is turned so that the tube E' is in connection with the bulb of the pipette, the levelling-bulb being in a low position and the stop-cock s left open. The pipette is entirely filled with the gas, then the stop-cock M is turned so that it communicates with the outer air, and the gas is completely expelled from the pipette. The gas is in this way drawn in and out of the pipette at least three times in order to make sure that all foreign gas (air) is removed from the rubber tubing. The sample of gas is then taken and the two stop-cocks M and s are closed.

In order to bring the gas to be tested from the Drehschmidt pipette into the eudiometer, the two instruments are connected by means of the capillary E' (imagine the capillary E in Fig. 105 to be replaced by E') and the rubber connections are firmly wired to the glass. The stop-cock M is turned to the position shown in Fig. 105, the levelling-bulb K is raised (after previously causing the mercury in the manometer-tube to reach to the point a) and the burette is entirely filled with mercury until the latter begins to flow from out of the tip of the key at M , when the cocks A and p are closed. The cock M is then turned so that the pipette S and the burette W are in connection, K' is raised; s opened, K lowered, and both p and A are opened.

After about 40 c.c. of the gas have passed over into the eudiometer, the cocks A and M are closed, the key of the stop-cock M (which must be entirely filled with mercury) is dipped into a beaker containing mercury, and the gas in the capillary is sucked into W by lowering K and opening A and p . As soon as the capillary E is entirely filled with mercury, A , p and finally M are closed.

The volume of the gas in W is now determined as follows: A is opened and K raised so that the mercury in the bulb is a little higher than it is in W . After this p is opened and the gas is driven over towards C until the mercury in both arms of the manometer-tube is at about the same height, when A is immediately closed. The last fine adjustment of the mercury levels within the tubes is made by closing or opening

the screw-cock Q ;* the volume is now read, and to the reading the correction corresponding to the volume between the marks M and a is added.

From this point begins the analysis.

1. Determination of Carbon Dioxide.

With the stop-cock p closed, the cock M is turned as shown in Fig. 105 the Drehschmidt pipette is removed and replaced by a second, clean pipette completely filled with mercury. On connecting the stop-cock M with the rubber connector of the capillary E' , it should be in the position shown in the drawing. By this means the mercury in the rubber tubing can flow out through the key. After wiring the rubber tightly to the glass, from 3 to 5 c.c. of caustic potash solution (1:2) are introduced through the key into the pipette M and the alkali in the capillary is washed out with about 2 c.c. of distilled water and then with a little mercury; after this the gas itself is driven over into the pipette. When the mercury has filled the whole capillary, both to the right and left of M , then A , p , and M are closed. The bulb K' is raised so that extra pressure is placed upon the gas in the pipette and s is closed. The pipette is now gently shaken for three minutes without disconnecting it from the eudiometer, after which the gas is returned to W as follows: M , p , and A are opened, K is lowered, K' raised, and s opened. When almost all of the gas has been driven out of the pipette, M , p , A , and Q are closed, the levelling-bulb is placed on the table below, and K' is placed upon the support (missing from Fig. 105, but shown in Fig. 112) upon which the pipette itself rests. M , p , A , and s are now opened and Q screwed up a little so that the gas is very slowly sucked into the burette. As soon as the caustic potash solution has reached M the latter is closed. The gas remaining in the capillary to the left of M is now removed by sucking mercury through the key of M into W . Finally the volume of the unabsorbed gas is read in the

* The reading is best made with the help of a small telescope, the ocular of which is provided with cross-hairs. For this purpose the telescope connected with a Bunsen spectroscopy is suitable.

same way as before. The difference between the two readings represents the amount of CO_2 .

2. Determination of the Heavy Hydrocarbons.

The pipette containing the caustic potash solution is removed and replaced by another containing fuming sulphuric acid.* The gas is driven over into the latter, shaken with the acid for three minutes,† and the pipette emptied in precisely the same way as before. The gas is now returned to the pipette containing the caustic potash in order to remove the acid vapors, and finally transferred to the burette *W* and its volume read. The difference before and after the treatment with fuming sulphuric acid represents the sum of the heavy hydrocarbons (C_2H_4 , C_6H_6 , C_2H_2 , etc.). It is not usually customary to attempt to separate the benzene from the ethylene.

3. Determination of Oxygen.

This part of the analysis is carried out in exactly the same way as the determination of the CO_2 , except that in this case the absorption pipette contains an alkaline solution of pyrogallol (cf. pp. 758-9).

4. Determination of Carbon Monoxide.

The determination of carbon monoxide may be effected either by absorption with ammoniacal cuprous chloride or by simultaneous combustion with hydrogen and methane.

For the absorption method, the procedure is the same as in the case of the determination of the heavy hydrocarbons, i.e., the absorption is effected in a pipette containing only ammoniacal cuprous chloride (no mercury). The gas is shaken for three minutes with a solution of cuprous chloride which has already been used frequently, and then the same length of time with a fresh,

* In this pipette the bulb-tube *K'* is fused on to the absorption-bulb, so that it is a little higher than the latter, in the same way as in the Hempel pipette (Fig. 115). Mercury is acted upon by fuming sulphuric acid.

† From the experience of the Massachusetts Gas Inspectors it would seem as if more time were necessary for the complete absorption of the heavy hydrocarbons—perhaps thirty minutes instead of three.—[Translator.]

or little used, solution (cf. pp. 763-4). Before reading the volume of the unabsorbed gas it must be freed from ammonia vapors, which is accomplished by shaking with hydrochloric acid (1.2) in a Drehschmidt pipette.

5. Determination of Hydrogen and Methane.

After the removal of the carbon monoxide, the gas may consist of hydrogen, methane, and nitrogen. An excess of oxygen is added to this mixture (with illuminating-gas twice its volume is added, while with Dowson, water, and producer gas only a little more than half as much oxygen is necessary). The eudiometer *W* is connected with a Drehschmidt pipette entirely filled with pure mercury * by means of a Drehschmidt platinum capillary (Fig. 105, *V*), and the latter is heated to bright redness with the non-luminous flame of a Teclu burner, taking care that the inner flame mantle does not come in contact with the platinum. The gas mixture is conducted three times in a slow stream through the hot platinum tube, but taking care that no mercury enters the latter. The volume of the unconsumed gas is then measured without removing the platinum capillary, and the carbon dioxide is determined by introducing some caustic potash into the pipette and then shaking the gas with it; after three minutes' shaking, the unabsorbed gas is returned to the eudiometer, closing the stop-cock *M* as soon as the caustic potash solution reaches it.

Calculation of Hydrogen and Methane.

Assume *V* c.c. of gas to be taken for the analysis. The residue remaining after the absorption of the CO_2 , C_nH_{2n} , O, and CO was mixed with oxygen and burned. The contraction produced was V_C and the CO_2 formed amounted to V_K .

We saw on p. 774 that the volume of the methane is equal

* There must be no trace of caustic potash in the pipette, because in that case CO_2 would be absorbed and an inaccurate result would be obtained. To make sure that all the alkali is removed, the pipette is washed first with water, then with hydrochloric acid, and finally with water once more.

to the volume of the CO_2 formed, V_K , and in per cent.:

$$V:V_K=100:x$$

$$x=\frac{V_K}{V}100=\text{per cent. CH}_4.$$

Since by the combustion of one volume of CH_4 two volumes of gas disappear, it is evident that by the combustion of V_K c.c. of CH_4 the contraction will amount to $2V_K$.

If the latter value be subtracted from the total contraction V_C , the difference represents the contraction caused by the combustion of the hydrogen present ($V_C - 2V_K$) and two-thirds of the latter represents the amount of hydrogen,

$$\frac{2(V_C - 2V_K)}{3} = \text{H},$$

and in per cent.:

$$V:\frac{2}{3}(V_C - 2V_K) = 100:x$$

$$x = \frac{200(V_C - 2V_K)}{3V} = \text{per cent. H.}$$

Determination of Carbon Monoxide, Methane, and Hydrogen by Combustion.

After the absorption of the CO_2 , C_nH_{2n} , and O, the residual gas consists of CO, CH_4 , H, and N. To it a measured volume of oxygen* is added, the mixture burned, and both the contraction, V_C , and the carbon dioxide formed, V_K , are estimated. After this the unused oxygen is determined by absorption with alkaline pyrogallol solution. If the excess of oxygen is subtracted from the amount originally added, the difference will give the amount of oxygen necessary for the combustion, V_O .

*The purity of the oxygen must be tested before the analysis, because the commercial product almost always contains nitrogen. For the analysis a measured volume of nitrogen is added to a definite amount of oxygen, as otherwise the amount of the residual gas might be too small to fill the manometer-tube between the marks *a* and *m* (Fig. 105). The nitrogen is prepared by allowing air to stand over phosphorus in a Hempel pipette. (Cf. p. 759).

If the amount of CO is denoted by x , the CH_4 by y , and finally the hydrogen by z , we have the following three independent equations:

$$1. V_C = \frac{1}{2}x + 2y + \frac{3}{2}z,$$

$$2. V_K = x + y,$$

$$3. V_O = \frac{1}{2}x + 2y + \frac{1}{2}z;$$

and from these equations we find that

$$x = \frac{4}{3}V_K + \frac{1}{3}V_C - V_O = \text{CO},*$$

$$y = V_O - \frac{1}{3}(V_K + V_C) = \text{CH}_4,$$

$$z = V_C - V_O = \text{H}.$$

* According to A. Wohl (Berichte, 1904, 433) the results are not quite accurate when obtained in this way because the molecular volume does not always equal the theoretical value of 22.41 liters. Nernst, in his book on Theoretical Chemistry, gives the following molecular volumes:

For 1 gm.-mol. of the gas,	or referred to oxygen.
$\text{H}_2 = 22.43 \text{ l.}$	$\text{H}_2 = 1.0017$
$\text{O}_2 = 22.39 \text{ l.}$	$\text{O}_2 = 1.0000$
$\text{CO} = 22.39 \text{ l.}$	$\text{CO} = 1.0000$
$\text{CH}_4 = 22.44 \text{ l.}$	$\text{CH}_4 = 1.0020$
$\text{CO}_2 = 22.26 \text{ l.}$	$\text{CO}_2 = 0.9939$

Taking these values into consideration, A. Wohl obtains for x CO, y CH_4 , and z H_2 , the following formulas:

$$x = 0.3329V_C - V_O + 1.3394V_K,$$

$$y = -0.3336V_C + 1.0020V_O - 0.3340V_K;$$

$$z = 1.0005V_C - 1.0017V_O - 0.0060V_K.$$

F. Haber (Thermodynamik techn. Gasreaktionen, p. 289) sees no reason for modifying the Bunsen formulas in this way, for when a combustion analysis is carried out by explosion, the volume of gas after the explosion is so poor in carbon dioxide that the partial pressure of the latter does not vary much from that of an ideal gas, and, therefore, follows Avogadro's Rule.

It is quite another matter in the case of mixtures rich in carbon dioxide, as often occur in gas-volumetric analyses. In that case the weight of carbon dioxide (or of carbonate) is computed from the volume of the gas and accurate values are obtained by using the observed molecular volume of 22.26 for this gas (see p. 333).

The necessity of using the observed molecular volume instead of the theoretical value has been shown by Treadwell and Christie (Z. angew. Chem., 1905, 1930) for chlorine. With other vapors (NH_3 , HCl , SO_2 , N_2O) the observed molecular volume should be used unquestionably.

In order to illustrate the accuracy of the method, the results obtained in the analysis of the gas from a Dowson gas generator with the help of the Deville tube (Fig. 100, cf. p. 732) will be given. Two samples of the gas were taken, one 35 cm. and the other 45 cm. above the grate. The height of the coal layer in the producer amounted to 45 cm.

DOWSON GAS.

Sample I (35 cm. above the grate).

	I.	II.	Mean.
CO ₂ =	8.54	8.48	8.51
C _n H _{2n} =	0.30	0.30	0.30
O =	0.36	0.27	0.31
CO =	20.79	20.81	20.80
CH ₄ =	1.32	1.26	1.29
H =	21.84	22.27	22.05
N =	46.85	46.61	46.74
	<u>100.00</u> *	<u>100.00</u>	<u>100.00</u>

The above analysis was performed by Korbuly in the author's laboratory, and the carbon monoxide was determined by absorption in ammoniacal cuprous chloride, but in the following analysis this gas was determined, as described above, by simultaneous combustion with hydrogen and methane

DOWSON GAS.

Sample II (45 cm. above the grate).

	I.	II.	Mean.
CO ₂ =	8.58	8.55	8.56
C _n H _{2n} =	0.48	0.48	0.48
O =	0.17	0.26	0.21
CO =	20.79	20.59	20.69
CH ₄ =	0.43	0.43	0.43
H =	19.31	19.22	19.26
N =	50.24	50.47	50.37
	<u>100.00</u>	<u>100.00</u>	<u>100.00</u>

* These analyses add up to exactly 100 per cent. simply because the nitrogen is determined by difference.—[Translator.]

Obviously, the above results are perfectly satisfactory; it is worth mentioning, however, that according to the former method (absorption of the CO and combustion of the residue) the value obtained for the methane is almost invariably somewhat higher, and that for hydrogen a trifle lower than according to the second method. To illustrate this, the results of a third analysis* will be given, which was also made by Korbuly in the sample of gas taken 35 cm. above the grate

Sample I (Dowson Gas, 35 cm. above the grate).

CO determined by absorption.	CO determined by combus ion.
CO ₂ = 8.51 †	8.45
C _n H _m = 0.30	0.33
O = 0.31	0.27
CO = 20.80	20.91
CH ₄ = 1.29	0.79
H = 22.05	23.38
N = 46.74	45.89
100.00	100.00

Of the two methods, the author decidedly prefers the latter.

Analysis according to H. Drehschmidt.‡

The apparatus of Drehschmidt, like that of Hempel, consists of the gas-burette *B* and the compensation-tube *C*, both of which are contained in a cylinder filled with water (Fig. 113).

Through the stop-cocks *a* and *b*, *B* and *C* are connected by means of capillary glass tubing in which a drop of a colored solution (indigo and sulphuric acid) is placed; in order to determine the position of the latter, the capillary is provided with

* The gas came from the same tube as in the case of the other analyses. The gas was removed from the tube, as described on pp. 731-2.

† This is the analysis given on p. 783.

‡ Berichte, 21 (1888), p. 3242.

a millimeter graduation. The three-way cock *a* can be turned so that *C* connects with the outer air or with the capillary, or so that the capillary is in connection with the air; it has an

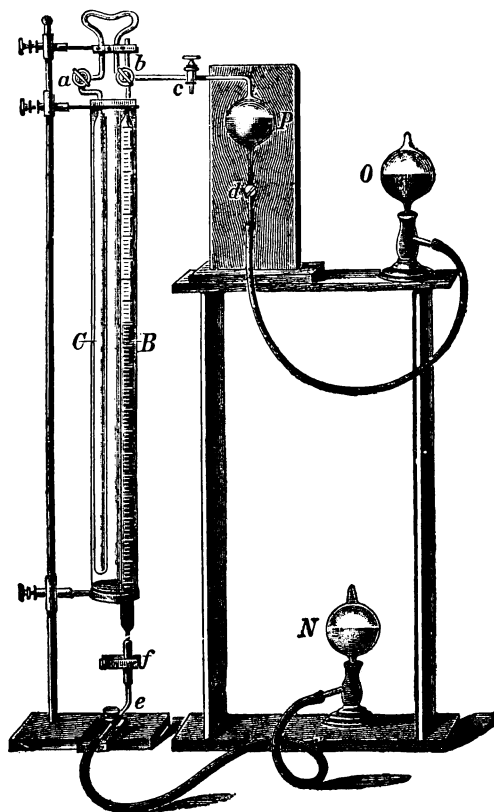

FIG. 113.

opening through the top of the key. The cock *b* has a right-angled boring like *H*, Fig. 105. The burette is divided into millimeters and must be calibrated with mercury before using. The apparatus is used in the same way as described under the Hempel method, p. 775.

TECHNICAL GAS ANALYSIS.

Method of Hempel.

The apparatus necessary is depicted in Fig. 114. It consists of a long measuring-tube ending at the top in a thick-walled capillary tube and connected at the bottom by means of rubber tubing about a meter long with the levelling tube.

The gas is confined over water which has been saturated with the gas to be examined, and the absorption is effected in Hempel's absorption pipettes such as are shown in Figs. 115, 116, 117, and 118.* Fig. 100 represents a *simple* pipette for liquid absorbents, while Fig. 101 shows a *compound* absorption pipette. The latter is used for solutions which undergo change on exposure to the air, e.g., an alkaline solution of pyrogallol, or an ammoniacal cuprous chloride solution. The liquid in the two right-hand bulbs serves to protect the solutions on the left. Fig. 117 shows the pipette used for fuming sulphuric acid. The small bulb is filled by the glass-blower with glass beads, which serve to give to the sulphuric acid the largest possible surface, so that the absorption is effected much more readily. Fig. 118 is a pipette used for solid absorbents, such as phosphorus, etc. In order to fill it with phosphorus, the pipette is placed upside down, the cylindrical part is filled with distilled water, and small sticks of colorless phosphorus are introduced. After filling the pipette, the rubber stopper is inserted, the apparatus is placed right side up, water is poured into the bulb, and any air-bubbles in the cylindrical part of the pipette are removed by blowing through the bulb until the water flows out from the top of the left-hand capillary, which is then closed by means of rubber tubing and a pinch-cock.

Analysis of Illuminating-gas.

First of all the confining liquid is prepared by conducting the gas through distilled water in a wash-bottle for several minutes with constant shaking.

*These wooden pipette stands are no longer much used; iron ones are preferred.—[Translator.]

The gas-burette is filled entirely full with this liquid and then the upper rubber tubing is closed with a pinch-cock. In order to fill the burette with gas, the receiver is connected with

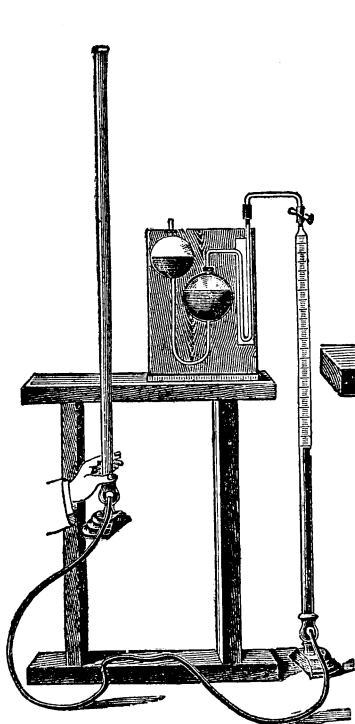

FIG. 114.

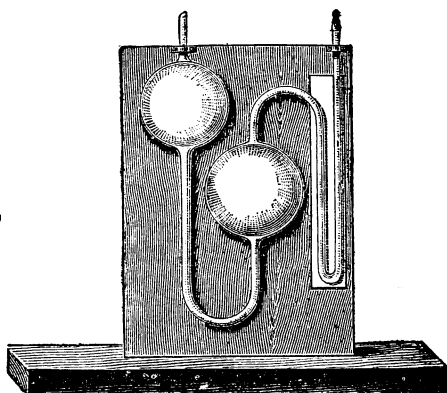

FIG. 115.

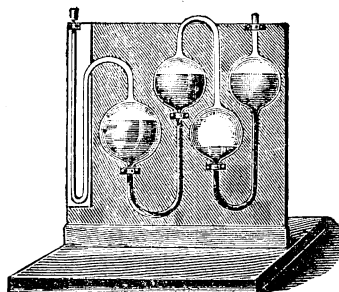

FIG. 116.

the burette by means of a piece of rubber tubing through which the gas has been flowing for two or three minutes, the levelling-tube is lowered, the pinch-cock opened and a little more than 100 c.c. of the gas are allowed to flow into the burette. The upper cock is now closed, the levelling-tube raised until the lower meniscus of the confining liquid is exactly at the 100-c.c. mark, when the rubber between the levelling-tube and the burette is closed near the burette with a pinch-cock. The apparatus is allowed to stand until the water no longer rises in the burette; this requires

two or three minutes. When the water is stationary, the lower pinch-cock is carefully opened (for there is extra pressure in the burette) which causes the water-level to sink. When the 100-c.c. mark is again reached, this cock is closed, the upper pinch-cock is opened an instant in order to allow the excess of gas to escape and then immediately closed. Then, to make sure that the burette contains exactly 100 c.c. of the gas, the lower pinch-cock is opened and after bringing the water in the levelling-tube to the same height as in the burette, the reading is taken; the lowest point of the meniscus should coincide exactly with the 100-c.c. mark of the burette. Finally the lower pinch-cock is closed.

1. Determination of Carbon Dioxide.

The burette is connected with a pipette containing caustic potash solution by means of a capillary filled with water, as shown in Fig. 114, the levelling-tube is raised, first the lower pinch-cock and then the upper one * is opened and the gas is driven over into the pipette. The confining liquid should now fill the entire capillary. The upper pinch-cock is closed, the pipette taken up and shaken for three minutes, † and the gas is returned to the burette, taking care that none of the alkali enters with it.

The liquid in the levelling-tube is brought to the same level as that in the burette; the lower pinch-cock is closed and after the water has completely drained from the sides of the tube, the volume of the unabsorbed gas is read.

2. Determination of the Heavy Hydrocarbons, C_nH_{2n} .

The burette is connected by means of a dry, empty capillary with sulphuric acid pipette (Fig. 117) and the gas is passed back and forth four times, taking care that no water enters the pipette and that the sulphuric acid does not reach the rubber connection.

Before the experiment the position of the sulphuric acid is

* In the figure this pinch-cock is lacking.

† The absorption takes place more rapidly with one of Hempel's new pipettes, which is similar to the one shown in Fig. 117, except that the right-hand bulb is replaced by a movable levelling-bulb, as in Fig. 105. The latter is filled with mercury, upon which the liquid absorbent floats. For the absorption of CO_2 , it is only necessary to pass the gas back and forth once.

marked upon the milk-glass plate back of the pipette and at the end of the experiment the acid must come to the same mark. The gas in the burette is now contaminated with acid vapors which

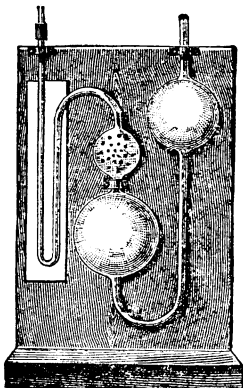

FIG. 117.

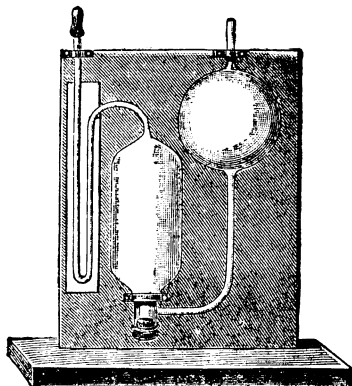

FIG. 118.

are removed by passing it into the potash pipette, afterwards returning it to the burette.

3. Determination of Oxygen.

This can be effected by shaking the gas in the compound pipette with alkaline pyrogallol solution, but far preferably by means of phosphorus. In the latter case, the gas is driven over into the phosphorus pipette and allowed to remain there until the white vapors disappear; this usually requires but three or four minutes (cf. p. 759). If no white vapors can be detected, this shows conclusively that the absorption of the heavy hydrocarbons was incomplete (cf. p. 759). In such a case, the gas must be again treated with sulphuric acid and afterwards with phosphorus. If no white fumes are then formed, no oxygen is present, a case which practically never occurs, for in the determination of the hydrocarbons a little air containing oxygen always reaches the gas from the small capillary.

4. Determination of Carbon Monoxide.

The gas is shaken three minutes with an old solution of ammoniacal cuprous chloride and then the same length of time with a fresh solution. (See pages 763, 779.)

5. Determination of Hydrogen and Methane.

After the absorption of the carbon monoxide the residual gas is placed in the hydrochloric acid pipette, while the burette is washed out with hydrochloric acid in order to remove traces of alkali, and then filled with distilled water.

About 15 to 16 c.c. of the gas in the hydrochloric acid pipette are transferred to the burette, and after reading its volume it is driven over into an explosion pipette containing mercury (Fig. 110). 100 c.c. of air (containing 20.9 c.c. of oxygen) are accurately measured off in the burette and added to the contents of the explosion pipette. The latter is then closed by means of a pinch-cock, the contents of the pipette are mixed by shaking, the levelling-tube is lowered so that the gas is placed under reduced pressure, and the glass stop-cock of the pipette is closed. The platinum wires which are fused in the upper part of the bulb are now connected with the poles of a small induction coil so that sparks pass between the platinum points within the pipette. The explosion at once occurs with a flash without ever breaking the pipette. The gas is returned to the burette. It would seem natural to read the volume of the gas and then determine the amount of carbon dioxide formed, the latter being a measure of the amount of methane burned. This is not advisable, however, because the gas in the burette is confined over water which absorbs appreciable quantities of carbon dioxide.* Consequently without reading the volume of the gas, it is transferred to the potash pipette, the carbon dioxide removed, and the volume of the gas then read; this gives the contraction V_c . Finally, the amount of unused oxygen is determined by means of absorption with phosphorus. If the excess of oxygen is subtracted from the total amount added (20.9 c.c.), the amount of oxygen required for the combustion is determined (V_o), so that we have two equations from which the amount of hydrogen and methane can be computed.

* Subsequent experiments have shown that the error caused by absorption of CO_2 by the water is so slight, during the short time of waiting, that it is better to determine the CO_2 with caustic potash after the explosion, as Hempel also recommended. The results thus obtained are usually more concordant than those by the method described in the text. (See p. 792.)

If we represent by x the volume of the hydrogen, and by y the volume of the methane we have

$$1. V_c = \frac{3}{2}x + 3y,$$

$$2. V_o = \frac{1}{2}x + 2y,$$

and from these equations we find

$$x = \frac{4}{3}V_c - 2V_o,$$

$$y = V_o - \frac{1}{3}V_c.$$

The values thus obtained are referred to the total gas residue and in this way the amount of hydrogen and methane present in the illuminating gas is determined.

Great accuracy is naturally not to be expected by such an analysis, but the procedure is very satisfactory for an approximate estimation. In order to illustrate this point, the results of analyses made by two different students in the author's laboratory at the same time will be given.

Analysis of Zurich Illuminating-gas by Hempel's Technical Method.

	I.	II.
Gas taken	100 c.c.	100 c.c.
	→1.8% CO ₂	→1.8% CO ₂
After removal of CO ₂	98.2	98.2
	→3.6% C _n H _{2n}	→3.6% C _n H _{2n}
“ “ “ C _n H _{2n} ...	94.6	94.6
	→0.6% O	→0.6% O
“ “ “ O	94.0	94.0
	→8.6% CO	→8.8% CO
“ “ “ CO	85.4	85.2
For the H and CH ₄ determination were taken of		
gas	16.0	15.6
+ air	116.0	115.6
	→30.0 = V _o	→29.8 = V _o
After the explosion.....	86.0	85.8
	→5.2 excess oxygen	→5.6 excess oxygen
“ removal of excess of O	80.8	80.2
V _o = 20.9 - 5.2 = 15.7.		V _o = 20.9 - 5.6 = 15.3.

If the values of V_c and V_o are inserted in the above equations, we have:

$$\begin{array}{ll} \text{Hydrogen } x=8.6 & x=9.1 \\ \text{Methane } y=5.7 & y=5.4 \end{array}$$

and in per cent.:

$$\begin{array}{ll} x=45.9\% \text{ H} & x=49.7\% \text{ H} \\ y=30.42\% \text{ CH}_4 & y=29.5\% \text{ CH}_4 \end{array}$$

SUMMARY OF THE TWO ANALYSES.

	I.	II.	Difference.
CO ₂	1.8	1.8	0.0
C _n H _{2n}	3.6	3.6	0.0
O	0.6	0.6	0.0
CO	8.6	8.8	0.2
H	45.9	49.7	3.8
CH ₄	30.4	29.5	0.9
N	9.1	6.0	3.1

From the results obtained, it is obvious that in each case the values obtained by absorption agree closely; on the other hand, the two determinations of hydrogen differ by almost 4 per cent. while that of methane shows a divergence of nearly 1 per cent.

It is possible to obtain a much closer agreement than the above in the determination of hydrogen and methane, but the analysis is inaccurate on account of the fact that only one-fifth of the residual gas is taken for the explosion; thus every error is multiplied by five.

As was mentioned in the foot-note on page 790, the gas residue may be analyzed as under (a) with the exception that the CO₂ obtained by combustion is measured. Then, if the volume of the hydrogen = x and that of the methane = y , the

$$\text{contraction} = V_c = \frac{2}{3}x + 2y.$$

$$\text{CO}_2 (= \text{CH}_4) = V_k = y$$

from which the hydrogen (x) can be computed as follows:

$$x = \frac{3}{2}(V_c - 2V_k).$$

As an example of this kind of an analysis, two of the author's students analyzed independently a sample of illuminating gas from Montbéliard.

	I	II
Taken	100 c.c.	100 c.c.
-CO ₂	97.4 c.c.=2.6% CO ₂	97.2 c.c.=2.8% CO ₂
-C _n H _{2n}	92.7 c.c.=4.7% C _n H _{2n}	92.4 c.c.=4.8% C _n H _{2n}
-O ₂	92.4 c.c.=0.3% O ₂	92.0 c.c.=0.4% O ₂
-CO	83.1 c.c.=9.3% CO	83.0 c.c.=9.0% CO
Of the residual gas there was taken for H and CH ₄ determination + air	15.4 c.c.	15.6 c.c.
	115.4 c.c.	115.6 c.c.
After the explosion	90.6 c.c.=24.8=V _c	90.2 c.c.=25.4 V _c
-CO ₂	84.5 c.c.=6.1=V _k =CH ₄	83.8 c.c.=6.4=V _k =CH ₄
-O ₂	80.3 c.c.=4.2=excess oxygen	79.8 c.c.=4.0=excess of O ₂

If the values of V_c and V_k are inserted in the above equations:

Hydrogen.....	x=8.4=45.3 per cent H ₂	x=8.4	44.7 per cent H ₂
Methane.....	y=6.1=32.9 " CH ₄	y=6.4	34.0 " CH ₄

SUMMARY OF THE TWO ANALYSES

	I.	II.	Difference.
CO ₂ =	2.6	2.8	0.2
C _n H _{2n} =	4.7	4.8	0.1
O ₂ =	0.3	0.4	0.1
CO=	9.3	9.0	0.3
H ₂ =	45.3	44.7	0.6
CH ₄ =	32.9	34.0	1.1
H ₂ =	4.9	4.3	0.6
	<hr/>	<hr/>	<hr/>
	100.0	100.0	

Much better results are obtained by the

(b) *Method of Winkler-Dennis.*

In this method, the entire gas residue is transferred to a Hempel pipette containing mercury and connected with a leveling bulb (Fig. 119). Through the rubber stopper at the bottom two steel needles are inserted (knitting needles), the longer of which is enveloped throughout its whole length by a glass tube, and the upper end is connected, at about three-quarters

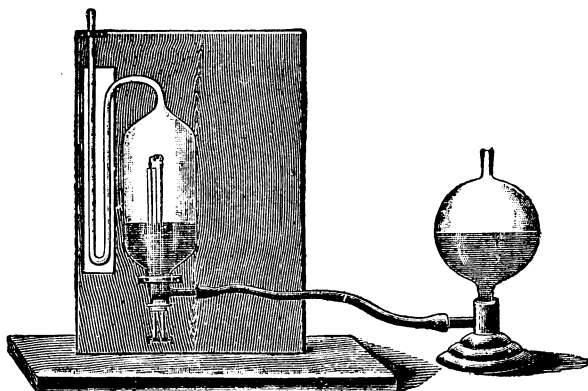

FIG. 119.

the height of the cylindrical part of the pipette, with a thin platinum spiral.

The pipette is now connected with a Hempel burette containing 100 c.c. of oxygen* over water, a low pressure is produced in the

* The oxygen used for experiments in gas analysis should preferably be prepared in the laboratory by heating potassium chlorate in a small retort, which is prepared by blowing a bulb (of about 20 c.c. capacity) at the end of a narrow piece of glass tubing; after introducing about 5 gms. of potassium chlorate, the tubing is bent to a right angle close to the bulb. The end of the tube is connected with a short piece of rubber tubing and the bulb heated over a free flame. As soon as oxygen begins to come off freely (lighting a glowing splinter) the rubber tubing from the retort is connected with a Drehschmidt absorption pipette, which contains a little caustic potash solution and is filled with mercury (cf. Fig. 105, p. 743). The oxygen is not

oxygen burette by lowering the leveling tube and then closing the rubber tubing with a screw-cock, after which the leveling tube is placed in a high position. The bottom ends of the two needles of the pipette are now connected with the wires of a small storage battery of such a strength that the platinum spiral heated to dull redness. By lowering the leveling bulb, a slightly lower pressure is produced in the pipette, and by opening the

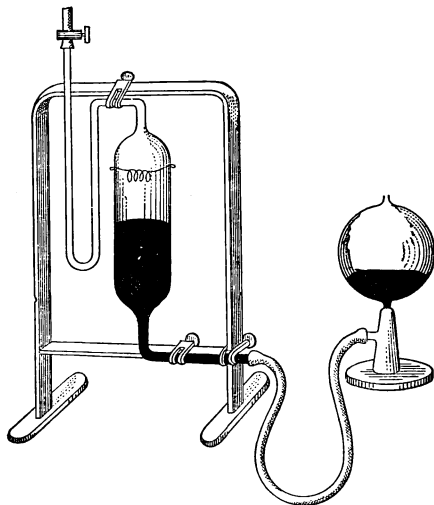

FIG. 120.

two upper screw-cocks between the pipette and the oxygen burette, and gradually opening the lower screw-cock on the burette, a very slow stream of oxygen is conducted into the pipette. Since a large excess of the gas residue is present at the start, the combustion takes place quietly; explosions never occur. During the

introduced at once into the pipette, but is allowed to pass through the cock *M* into the air. After about a minute, one can assume that the air from the retort and rubber tubing has been entirely replaced by oxygen. The leveling bulb *K* of the pipette is lowered, the cock *s* opened, and the cock *M* turned 90° so that the pipette fills with oxygen. When the filling is accomplished, *M* is closed and the retort removed. By shaking the pipette, any carbon dioxide formed by the burning of dust, etc., is absorbed.

combustion the platinum spiral begins to glow more brightly; to prevent its melting, a resistance * must be placed in the circuit by means of which the strength of current, and thus the glowing of the platinum, may be regulated as desired.

As soon as all the oxygen is in the pipette, the spiral is allowed to glow two or three minutes longer, the electric current is then stopped, and the gas allowed to remain in the pipette for fifteen minutes so that it will assume the room temperature. It is then transferred to a Hempel burette and its volume measured; the carbon dioxide is determined in the usual manner.

To illustrate the accuracy of this technical method, the following three analyses were carried out independently by three of the author's students.

ANALYSIS OF ZURICH ILLUMINATING-GAS ON JULY 14, 1909.

	I	II	III
CO ₂	2.0%	2.2%	1.9%
C _n H _{2n}	4.4	4.4	4.6
O ₂	0.7	0.5	0.6
CO	9.2	9.2	9.3
CH ₄	27.6	28.2	27.9
H ₂	49.8	49.4	49.3
N ₂	6.3	6.1	6.4
	100.0%	100.0%	100.0%

Remark.—By this method it is possible to burn pure acetylene without any explosion. The oxygen, however, must not be conducted, as above, into the acetylene because in that case the combustion of the acetylene will be incomplete and considerable carbon will deposit. If the oxygen is first placed in the combustion pipette, the platinum wire brought to glowing, and then the acetylene introduced, the combustion takes place nicely without deposition of any carbon.

The Winkler-Dennis pipette is open to the objection that the rubber stopper eventually leaks; for this reason the author prefers the form of apparatus devised by his assistant, M. Bretschger, as shown in Fig. 120.

* The resistance mentioned on page 178 is suitable to use here.

Instead of burning the gas residue according to the Winkler-Dennis method, it may be conducted over glowing cupric oxide.*

Orsat's Apparatus.

For the analysis of flue gases, Orsat has constructed the apparatus shown in Fig. 121. It consists of the 100 c.c. measuring-tube

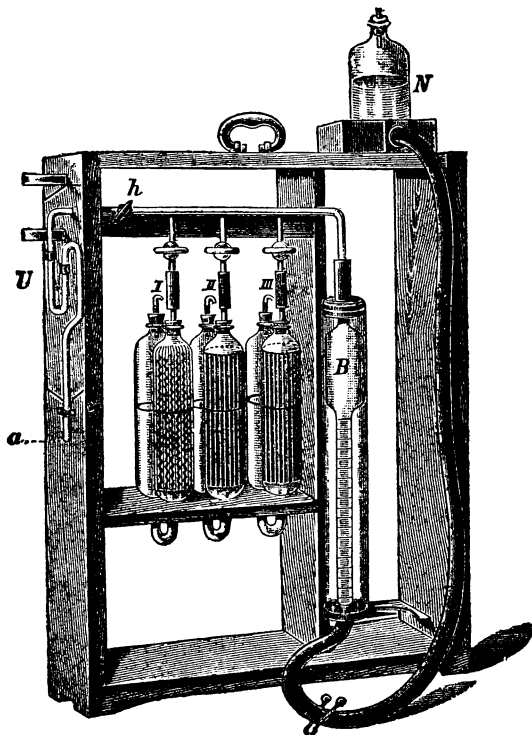

FIG. 121.

B surrounded by a cylinder containing water, and connected on the one hand with three Orsat tubes by means of the cocks *I*, *II*, and *III*, and the other hand with the outer air through the stop-cock *h*. The Orsat tube *III* contains caustic potash, *II* alkaline pyrogallol solution, and *I* ammoniacal cuprous chloride solution.

* Jager, *J. Gasbeleuchtung*, 1898, 764. G. v. Knorre, *Chem. Ztg.*, 1909, 717.

Manipulation.—By raising the leveling-bottle *N* and opening the stop-cock *h*, the measuring-tube *B* is filled with water. As soon as the water is above the mark in the widened part of the measuring-tube, the rubber tubing between the levelling-bottle and the measuring-tube is closed by means of a pinch-cock, *a* is connected with the source of the gas, and the gas is sucked into the measuring-tube by lowering the levelling-bottle and opening the pinch-cock. The U tube on the outside of the apparatus is filled with glass-wool and serves as a filter; any smoke being removed from the gas to be examined. The sample thus collected is naturally contaminated with the air from the rubber tubing, the U tube, and the capillary, which must be removed. The cock *h* serves for this purpose and is provided with a T boring. The cock is turned so that the burette communicates with the outer air through a small tube (not shown in the illustration) and the gas is expelled by raising the bottle *N*. This process of filling and emptying is repeated three times, and the fourth filling of the tube *B* is taken for the analysis. The gas in the burette is brought to the 0 mark, and it is placed under atmospheric pressure by quickly opening and then closing *h*. After this the gas is driven over into the potash-bulb and back again to the measuring-tube several times, until there is no further absorption, after which the volume of the gas is again read. In the same way the gas is successively passed into the pyrogallol and the cuprous chloride tubes, thus obtaining the amount of CO₂, O, and CO in the gas.

Bunte's Apparatus.

This apparatus, shown in Fig. 122, differs from those previously described, inasmuch as the absorption takes place in the measuring vessel itself, whereas in the other cases the absorption takes place in the pipettes.

The Bunte burette has a capacity of about 110 to 115 c.c. between *a* and *b*; *a* is a three-way cock, while *b* is bored only once.

Manipulation.—The burette is connected with the levelling-bottle *N*, as shown in the illustration, *a* and *b* are opened, and the water is allowed to run up to the mark in the funnel above *a*. The key of the stop-cock *a* is connected with the source of the gas, *N* is lowered, *a* turned to the proper position, and

the gas is sucked into the burette. After about 101 to 103 c.c. of the gas have entered the burette, *a* and *b* are closed, *N* is raised, and by opening *b* the gas in the burette is compressed until the confining liquid has exactly reached the zero mark. The cock *a* is now cautiously opened, when some of the gas in the burette will escape through the water in the funnel. The gas in the burette is now under a pressure equal to that of the atmosphere plus the pressure from the column of water in the funnel, and all subsequent measurements are taken under the same conditions.

Absorptions.—In order to introduce the different absorbents into the burette, its lower end is connected by means of the rubber tubing *h* with the bottle *F* containing a little water, the water having been blown up into the rubber tubing. The cock *b* is opened, as is the screw-cock at *h*, and the water in the burette is allowed to run out until it exactly reaches the cock *b*, which is then closed. The absorbent is placed in a small dish, the lower tip of the burette is introduced into the liquid, and the cock *b* is opened. Inasmuch as the gas in the burette is under less than atmospheric pressure, the absorbent is sucked up into the burette. The cock *b* is now closed, the burette grasped above *a* and below *b* (in order not to warm the gas), and its contents well shaken, after which the burette is again dipped into the absorbent in the dish and a little more of the latter drawn up into the burette. This process is repeated until no more of the absorbent is sucked up into the burette. It would now be incorrect to read the volume of the unabsorbed gas, for it is under quite a different pressure than at the beginning of the analysis; namely, the atmospheric pressure less the pressure of the column of

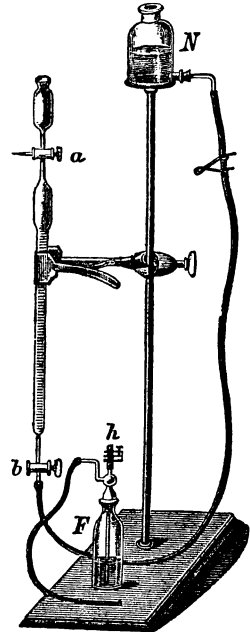

FIG. 122.

liquid remaining in the burette with the cock *b* open. Furthermore the vapor tension of the liquid in the burette is different from that of the water originally present. In order to obtain the original conditions, the burette is connected with the bottle *F*, which now only contains enough water to fill the rubber tubing and the glass tube, and the absorbent is sucked from the burette into the bottle until the upper level of the liquid reaches the cock *b*.* The end of the burette is then dipped into a dish containing water, which rises into the burette on opening *b*. The latter is closed and water is allowed to run into the burette from the funnel until the original pressure is established, when the volume of the gas is once more read. The difference gives at once the per cent. of absorbed gas.

By means of this excellent method the carbon dioxide can be removed by caustic potash, heavy hydrocarbons by bromine water, oxygen by alkaline pyrogallol solution, and carbon monoxide by cuprous chloride.

ANALYSIS OF GASES WHICH ARE ABSORBED CONSIDERABLY BY WATER.

Under this heading belong

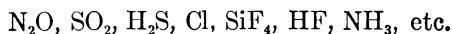

Nitrous' Oxide, N_2O . Mol. Wt. 44.02.

Density = 1.5297 † (Air = 1). Weight of 1 liter = 1.9766 gms.

Molar volume = 22.26 l. Critical temperature = +36° C.

This gas is best prepared according to the method of Victor Meyer, ‡ by allowing sodium nitrite to act upon a concentrated solution of a salt of hydroxylamine:

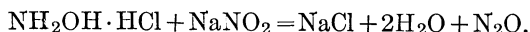

* The absorbent is now by no means exhausted, so that it is returned to the proper bottle, and can be used for several other determinations.

† Lord Rayleigh, Proc. Roy. Soc., 74, 181 (1904).

‡ Ann. Chem. Pharm., 157, 141.

It is best to proceed as follows:

A concentrated, aqueous solution of sodium nitrite is added drop by drop from a separatory funnel, with constant cooling, to a concentrated solution of hydroxylamine hydrochloride, which is contained in a small evolution flask; in this way the gas evolved is pure and escapes in a regular stream. It is not advisable to proceed in the opposite way, namely, to add the hydroxylamine solution to a concentrated nitrite solution, for in the latter case the decomposition is likely to take place with explosive violence; it is still less advisable to add one of the reagents in the solid form. In a very dilute condition the solutions scarcely act upon one another.

Nitrous oxide is never pure when it is prepared by heating ammonium nitrate; it is always contaminated with nitrogen and nitric oxide, but the latter may be removed by washing the gas with a solution of ferrous sulphate.

According to L. Pollak the solubility of nitrous oxide between 0° and 22° C. is expressed by the formula

$$\beta = 1.13719 - 0.042265 \cdot t + 0.000610 \cdot t^2,$$

while according to Bunsen its solubility is greater, being expressed by the formula

$$\beta = 1.3052 - 0.045362 \cdot t + 0.0006843 \cdot t^2.$$

The gas is absorbed to a much greater extent by alcohol than by water. According to Pollak, the absorption coefficient for alcohol is

$$\beta = 3.22804 - 0.04915 \cdot t + 0.00023 \cdot t^2,$$

while according to Bunsen it is somewhat greater:

$$\beta = 4.17805 - 0.069816 \cdot t + 0.000609 \cdot t^2.$$

The determination of nitrous oxide can be effected with accuracy by combustion, and this may be carried out in two different ways:

1. According to Bunsen, by exploding with hydrogen, or according to Knorre, by means of the Drehschmidt capillary. The contraction produced is equal to the original volume of the nitrous oxide:

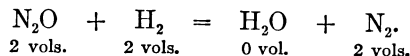

2. According to Pollak, by combustion with pure carbon monoxide, either by explosion or with the help of the Drehschmidt capillary; the volume of the CO_2 formed, which is measured, is equal to the volume of the nitrous oxide:

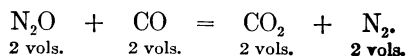

There is no contraction in this case.

Nitric Oxide, NO. Mol. Wt. 30.01.

Density = 1.0366,* (Air = 1). Weight of 1 liter = 1.3402 gms.

Molar volume = 22.39 l. Critical temperature = -94°C .

Preparation of Pure Nitric Oxide.

The best way to prepare pure nitric oxide is the method of A. Deventer,† in which a solution of potassium ferrocyanide and potassium or sodium nitrite is acidified with acetic acid and shaken:

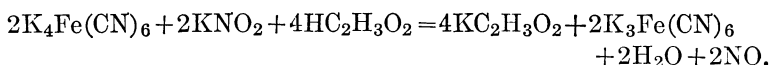

According to Emich ‡ a very pure gas is obtained by shaking a nitrate with concentrated sulphuric acid in a nitrometer containing mercury.

* Computed from observations of Gray (1905), Guye and Davila (1906).

† Berichte, 26, 589 (1893).

‡ Monatshefte, 13, 73 (1892).

ABSORPTION COEFFICIENTS OF NITRIC OXIDE FOR WATER.*

Temperature.	β	Temperature.	β
0°	0.07381	30°	0.04004
5	0.06461	35	0.03734
10	0.05709	40	0.03507
15	0.05147	45	0.03311
20	0.04706	50	0.03152
25	0.04323	55	0.03040

Although nitric oxide is only slightly soluble in water, its determination will be discussed at this place because this gas frequently occurs with nitrous oxide, and must therefore be determined at the same time.

Nitric oxide may be determined by absorption with a concentrated solution of ferrous sulphate or an acid solution of potassium permanganate, likewise, according to E. Divers,† by an alkaline solution of sodium sulphite (40 gms. $\text{Na}_2\text{SO}_3 + 4$ gms. KOH in 200 c.c. H_2O) with the formation of $\text{Na}_2\text{N}_2\text{O}_2\text{SO}_3$.‡ It is better, however, to carry out a combustion by the method of Knorre and Arndt,§ in which the gas is mixed with hydrogen and very slowly passed through a Drehschmidt's platinum capillary heated to bright redness. Under these conditions the nitric oxide is quantitatively burned according to the equation.

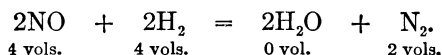

The contraction produced by the combustion of one volume of nitric oxide is equal, therefore, to $\frac{2}{3}$ the original volume of the gas.

Remark.—If the gas mixture is passed too quickly through a platinum capillary heated to bright redness, or slowly through a less strongly heated platinum capillary, an appreciable amount of ammonia is formed and the results obtained are inaccurate.

By explosion with hydrogen it is not possible to burn NO

* L. W. Winkler, *Berichte*, 34, 1414 (1901).

† *Journ. Science Coll. Imp. University; Tokio*, Vol. XI (1893), p. 11.

‡ Nitric oxide is only partially absorbed by an alkaline solution of pyrogallol, where alkali nitrite, N_2O , and N_2 are formed. (C. Oppenheim, *Berichte*, 36, 1744 (1903).

§ *Berichte*, 21 (1889), p. 2136.

when it is pure; when it is mixed with considerable nitrous oxide, violent explosions take place, yet the combustion of the NO is even then not quantitative.

The gas may be determined, however, by combustion with carbon monoxide in the Drehschmidt capillary.

According to Henry a mixture of carbon monoxide and nitric oxide is not explosive. On the other hand, according to Pollak, by conducting a mixture of these gases through a Drehschmidt platinum capillary heated to bright redness, the combustion is quantitative if at the same time the carbon dioxide formed is removed by means of caustic potash; * otherwise the oxidation is not quantitative. According to the equation

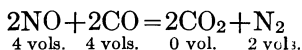

the contraction produced is equal to $\frac{3}{2}$ the volume of the nitric oxide.

Remark.—If considerable nitrous oxide is present at the same time, the combustion in the Drehschmidt capillary takes place quantitatively without the removal of the carbon dioxide. In this case the contraction is $\frac{1}{2}$ the volume of the nitric oxide.

Analysis of a Mixture of Nitrous and Nitric Oxides.

I. *Combustion with Hydrogen.*

The gas is mixed with an excess of hydrogen and oxidized according to Knorre in the Drehschmidt platinum capillary heated to bright redness. If the volume of the $\text{N}_2\text{O} = x$ and that of the $\text{NO} = y$, we have:

$$\begin{array}{l} \text{N}_2\text{O.} \quad \text{NO.} \\ 1. \quad x + y = V \\ 2. \quad x + y = \frac{3}{2}V_c \text{ (contraction)} \end{array}$$

from which can be calculated:

$$\begin{array}{l} x = 3V - 2V_c \\ y = 2(V_c - V). \end{array}$$

* The mercury in the Drehschmidt tube is covered with caustic potash solution, by which means the CO_2 is absorbed immediately after its formation.

II. Combustion with Carbon Monoxide.

The gas mixture is treated with an excess of carbon monoxide and burned in the red-hot platinum capillary; the contraction, V_c , and the carbon monoxide, V_k , are both determined;

$$\begin{array}{l} \text{N}_2\text{O. NO.} \\ x + y = V_k \\ \frac{1}{2}y = V_c \end{array}$$

from which we can compute:

$$\begin{array}{l} x = V_k - 2V_c \\ y = 2V_c. \end{array}$$

Determination of Nitrous Oxide, Nitric Oxide, and Nitrogen in the Presence of One Another.

I. By Combustion with Hydrogen in a Drehschmidt Capillary.

After noting the contraction formed by the combustion with hydrogen, an excess of oxygen is added to the gas residue and the mixture is burned in the Drehschmidt capillary; two-thirds of the contraction which now takes place is equal to the amount of unused hydrogen in the first oxidation. If this quantity is deducted from the amount of hydrogen originally added, the difference, V_w , represents the amount of hydrogen necessary.

We have now;

$$\begin{array}{l} \text{N}_2\text{O. NO. N.} \\ 1. x + y + z = V \\ 2. x + \frac{2}{3}y = V_c \\ 3. x + y = V_w \end{array}$$

from which we can compute

$$\begin{array}{l} x = 3V_w - 2V_c \\ y = 2(V_c - V_w) \\ z = V - V_w. \end{array}$$

II. *By Combustion with Carbon Monoxide in the Drehschmidt Capillary.*

We have:

$$\begin{array}{rcl} \text{N}_2\text{O.} & \text{NO.} & \text{N.} \\ x + y + z = V & & \\ \frac{1}{2}y & = V_c & \text{(contraction)} \\ x + y & = V_k & \text{(CO)}_2 \end{array}$$

from which it follows:

$$\begin{array}{l} x = V_k - 2V_c \\ y = 2V_c \\ z = V - V_k. \end{array}$$

Determination of Nitrous Oxide, Nitric Oxide, and Nitrogen in the Presence of Carbon Dioxide.

The accurate determination of nitrous oxide in the presence of carbon dioxide offers certain difficulties. It is not possible to determine the former by combustion with hydrogen in the Drehschmidt capillary, because when the carbon dioxide is present it takes part to some extent in the combustion,

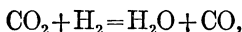

and the previous absorption of the carbon dioxide by means of a large quantity of caustic potash is equally unsatisfactory, because a considerable amount of nitrous oxide will be absorbed by the reagent. The only way which can be recommended to effect this determination consists in absorbing the carbon dioxide by means of the smallest possible quantity of caustic potash, in which case the error introduced by the absorption of the nitrous oxide is reduced to a minimum; the residual gas is examined as described above.

Nitrogen, Mol. Wt. 28.02.

Density = 0.9673 (Air = 1). Weight of 1 liter = 1.2505 gms.

Molar volume 22.41 liters. Critical temperature = -149°C .

Pure nitrogen is best prepared by heating a concentrated solution of potassium nitrate and ammonium chloride, present in amounts proportional to their molecular weights, and then

conducting the escaping gas over glowing copper to reduce traces of nitric oxide.

Nitrogen is but slightly soluble in water. According to L. Winkler,*

ABSORPTION COEFFICIENTS OF NITROGEN FOR WATER.

Temperature.	β	Temperature.	β
0°	0.02348	30°	0.01340
5	0.02081	35	0.01254
10	0.01857	40	0.01183
15	0.01682	45	0.01129
20	0.01542	50	0.01087
25	0.01432	55	0.01051

Nitrogen cannot be determined by any of the ordinary methods of gas analysis. It is always estimated by determining all the other constituents present in a mixture and subtracting the sum of the percentages found from 100.

Technical preparations of nitrogen, prepared from the air, always consist of nitrogen and small amounts of rarer elements. According to Cavendish these latter may be obtained by adding oxygen and allowing a strong electric spark to pass through the mixture. In this way the nitrogen is completely oxidized to nitric acid, which can be removed by means of caustic potash solution. Then, by absorbing out the oxygen, the rarer gases are obtained. A still better process is that of Hempel, in which the nitrogen is absorbed by passing the gas over a glowing mixture of 1 gm. magnesium, 5 gm. freshly burnt lime, and 0.25 gms. sodium. The rare gases are not absorbed by this treatment.

According to Bunsen, there is no combustion of nitrogen when detonating gas explodes in the presence of air, provided not more than 30 volumes of combustible gas are present for each 100 volumes of non-combustible gas. There is no oxidation of nitrogen during a combustion of a gas mixture which is passed through a Drehschmidt platinum capillary.

* Berichte, 21, 3606 (1891).

Analysis of Gases by Titration of the Absorbed Constituents.

If a mixture of gases contains several constituents, of which two are removed by the same absorbent, and one of these can be determined by titration, it is a matter of no difficulty to determine the amount of each. The diminution in volume after treatment with the absorbent represents the amount of the two constituents, the titration value represents the amount of one of them, and the difference shows the amount of the other. Such problems can be solved in a variety of ways, and only a few examples will be mentioned.

Chlorine, Cl. Mol. Wt. = 70.92.

Density = 2.488 (Air = 1).* Weight of 1 liter = 3.2164 gms.
Molar volume = 22.049 liters. Critical temperature = +146° C.

Determination of Carbon Dioxide in Electrolytic Chlorine.†

The author has used the apparatus shown in Fig. 123 with the best success for this purpose.

The absolutely dry eudiometer, *B*, the capacity of which between the two stop-cocks is accurately known, and for convenience may be 100 c.c., is filled through the lower cock, after the gas has been dried by passing it through a long calcium chloride tube.‡ After five or ten minutes it is safe to assume that the air has been completely replaced by the gas. The lower three-way cock is now closed and then the upper one. The temperature and barometric pressure are both noted at this point.

The tip of the burette is connected by rubber tubing with the reservoir *N*, the three-way cock is turned so that the reservoir communicates with the outer air, and then the lower

* Leduc, *Compt. rend.*, **116**, 968 (1893) and Treadwell and Christie, *Z. angew. Chem.*, **47**, 446 (1905).

† Treadwell and Christie, *Z. angew. Chem.*, **47**, 1930 (1905).

‡ If the burette and gas are not perfectly dry, some chlorine will be absorbed by the water. This will not affect the gas reading, but will be harmful in the subsequent titration.

tip of the burette and the stop-cock are thoroughly washed, after which the latter is closed. A solution of potassium

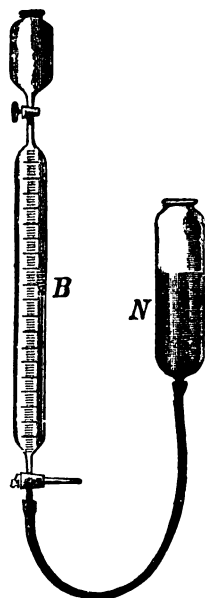

FIG. 123.

arsenite is prepared by dissolving 4.95 gms. As_2O_3 in dilute potassium hydroxide, adding dilute sulphuric acid until the solution is neutral to phenolphthalein and then diluting to 1 liter.* 100 c.c. of this solution are placed in *N* and any air in the rubber tubing is expelled by pinching it with the thumb and finger. By raising *N* and opening the stop-cock, a little of the arsenite solution is made to flow into the burette, which is inclined from side to side in such a way that the walls are thoroughly wet with the arsenite solution. The chlorine is slowly absorbed, as is evident from the fact that the solution slowly rises in the burette. As soon as there is no further absorption, the lower stop-cock is closed and the solution in the burette is made to flow back and forth in the burette several times, by inverting the burette and then turning it back again. After one or two minutes all of the chlorine will have

been absorbed. Then in order to absorb all the carbon dioxide present, the tube *N* is lowered, 10 c.c. of potassium hydroxide solution (1:1) are poured in the funnel, and carefully made to flow into the burette. The stop-cock is again closed and the alkali solution poured back and forth in the burette.

After the liquid in the burette and in the leveling tube has been brought to the same height, the reading is taken. The unabsorbed gas residue on being deducted from the original volume of the gas gives the volume of the chlorine plus that of the carbon dioxide. For the determination of the chlorine, the contents of the burette leveling tube, *N*, are emptied into a large Erlenmeyer flask and the stop-cock is turned to the position shown in the drawing, so

* An ordinary solution of arsenite prepared with sodium bisulfonate cannot be used here.

that the liquid in the rubber tubing can flow out. The tubing is then removed from the burette and washed out with distilled water which is also allowed to run into *N*. The contents of the burette are added and the burette itself is rinsed with distilled water.

The contents of the Erlenmeyer flask are treated with two drops of phenolphthaleïn solution and then with hydrochloric acid until the red color just disappears, 60 c.c. of sodium bicarbonate solution are added (35 gms. in 1000 c.c. water), a little starch solution, and the excess of the arsenious acid is titrated with $\frac{N}{10}$ iodine solution.

It will be assumed that *n* c.c. are used in the titration. The ratio of the arsenite solution to the iodine is then established in the same way as in the above titration. 100 c.c. of arsenite solution are placed in an Erlenmeyer flask, 10 c.c. of caustic-potash solution (1:2) are added, two drops of phenolphthaleïn, hydrochloric acid to decolorization, and then 60 c.c. of sodium bicarbonate solution. The solution is then diluted to the same volume as that of the original experiment and titrated with tenth-normal iodine. Hereby *n'* c.c. are required. The difference *n'* - *n* multiplied by 1.102 * gives the number of cubic centimeters of chlorine gas at 0° C. and 760 mm. pressure. In other words,

$$V'_0 = (n' - n) \times 1.102.$$

As, however, the original gas was measured at the temperature *t*° C. and under the pressure *B* mm., it follows according to page 666, that

$$V'_0 = \frac{V' \cdot B \cdot 273}{760 \cdot (273 + t)},$$

* This number is derived from the observation that the density of chlorine is 2.488 at 20°,

$$\frac{70.92}{0.001293 \times 2.488} = 22,045.$$

Therefore, 35.46 gms. of chlorine at 0° and 760 mm. occupy a volume of 11,020 c.c. In the paper just cited, the value 22,039.2 c.c. is taken for the molecular volume of the chlorine and 0.001293 for the density of air.

In the analyses of gases rich in chlorine, correct values are obtained by using the observed molecular volume of chlorine, which is 22.049 liters, and according to the experiments of N. Busvold in the author's laboratory, correct results are also obtained with this value in the analysis of gases containing little chlorine.

from which can be computed

$$V' = \frac{V_0 \cdot 760(273 + t)}{B \cdot 273}.$$

If V is the original volume of the gas used and R that of the residual gas in the burette, then

$$\begin{array}{r} \text{Cl}_2 + \text{CO}_2 + \text{Residue} = V \\ \text{Residue} = R \\ \hline \text{Cl}_2 + \text{CO}_2 = V - R \\ - \text{Cl}_2 = V_1 \\ \hline \text{CO}_2 = V - (R + V') \end{array}$$

and in per cent.

$$x = \frac{[V - (R + V')] \cdot 100}{V} = \text{per cent. CO}_2.$$

Remark.—In the first edition of this book the mixture of chlorine and carbon dioxide was absorbed by means of 5 per cent. caustic soda solution and the solution titrated with arsenious acid.

This method is not entirely correct, however, because it is based upon the assumption that the chlorine is absorbed by the alkali in accordance with the equation,



whereas in reality there is always some chlorate formed and escapes the titration.* Offerhaus,† therefore, uses two burettes

* The error here is practically constant and amounts to 0.77 per cent. chlorine. The work can be carried out according to the original method, adding, for the sake of accuracy, 0.7 per cent. to the value of chlorine found. Cf. O. Steiner, *loc. cit.*, and Treadwell and Christie, *loc. cit.*

† If the weight of chlorine found by titration is used in connection with the theoretical molecular volume, a considerable error will be introduced for, in spite of the formation of chlorate, about 0.9 per cent. too much chlorine will be found in electrolytic chlorine.

‡ Cl. Winkler (*Industriegase* II, 318) and Offerhaus (*Z. angew. Chem.*, 1903, 1033), also Lunge-Berl, *Chem. techn. Untersuchungsmethoden*, 6th edition, Vol. I, p. 582, and O. Steiner, *Z. Elektrochemie*, 1904, 327.

for the determination, absorbing the chlorine and carbon dioxide in one by means of caustic-potash solution, and absorbing the chlorine in another sample of gas by means of potassium iodide and the titrating with tenth-normal thiosulphate solution.

This is, however, an unnecessary complication, for besides requiring an additional burette it involves the use of more of the expensive potassium iodide. It is possible, however, to carry out the analysis in one burette by absorbing first the chlorine with 10 per cent. potassium-iodide solution, and then introducing caustic potash solution from the top of the burette. Hereby the carbon dioxide is absorbed and the iodine is transformed into iodide and iodate (the solution becomes nearly colorless):

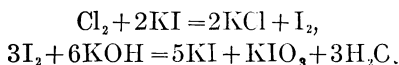

In order to determine the amount of iodine originally set free, the contents of the burette are allowed to flow into a potassium iodide solution which is acid with hydrochloric acid:

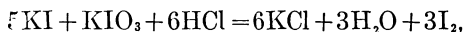

and the I.b. rated iodine is titrated with tenth-normal sodium thiosulphate solution.

The method has no advantage over that described above and is not quite as accurate.

Recently Schloetter has described another method for the examination of electrolytic chlorine gas. The chlorine is absorbed by means of hydrazine sulphate, whereby two volumes of chlorine set free one volume of nitrogen. The carbon dioxide is then absorbed by means of caustic soda solution.

P. Ferchland* determines the chlorine by absorption with mercury in the residual gas after the CO_2 has been absorbed with caustic potash. This last method, according to the experiments of Busvold,† gives good results; it is to be recommended especially for the analysis of chlorine gas from the Deacon process.

Examination of the Unabsorbed Gas Residue.—Usually the residual gas is too small in amount (as in the above case) to

* Z. Elektrochem., 13, 114.

† Inaug. Dissert. Zurich, 1909, also P. Philosophoff. Chem. Ztg., 1907, 959.

examine quantitatively, so that for this part of the analysis a larger sample of the gas is taken. The author has used the apparatus shown in Fig. 124 for this purpose with good results

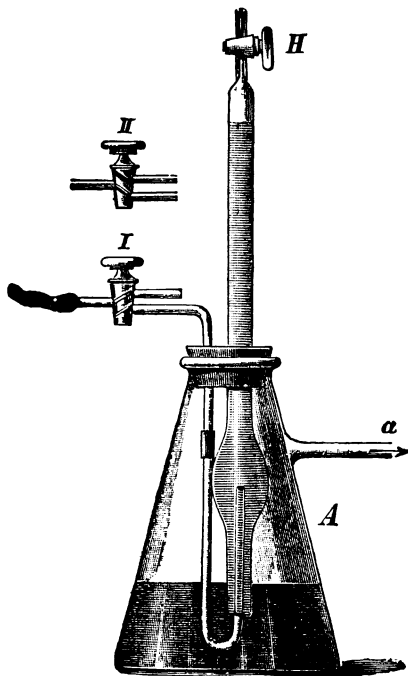

FIG. 124.

The thick-walled filter-bottle *A* has a capacity of about 1.5 liters. It contains about 500 c.c. of strong caustic potash solution and the absorption-tube with stop-cock *H* is fastened air-tight within it.

Manipulation.—First of all, the absorption-tube is entirely filled with the caustic potash solution by suction through *H*, finally closing the latter. The patent cock is then turned to the position *II*, and by suction through the left side-arm, the glass tube is filled with the alkali up to the cock. The latter is then turned to the position *I*, the left side-arm is connected, by means of a

* This apparatus has been used often by the author in the study of electrolytic chlorine gas and was described in the first edition of this text-book. Since then a similar apparatus has been recommended by Thiele and Deckert, *Z. angew. Chem.*, 20, 437 (1907).

short piece of rubber tubing and a long piece of glass tubing, with the source of the gas and several liters of gas are drawn through this tube by connecting the right side-arm with an aspirator. As soon as it is safe to assume that all of the air has been driven out from the tubing, the cock is turned to the position *II*, the aspirator is connected at *a* with the flask *A* in which a slight vacuum is produced, whereby the gas begins to collect in the absorption-tube. Chlorine and carbon dioxide are completely absorbed, while the residual gas collects in the upper part of the absorption-tube. The gas is allowed to enter the tube until from 50 to 70 c.c. of the gas residue are obtained; the cock *I* is then closed, the aspirator removed, and the gas driven over into a Hempel's gas-burette and analyzed according to the methods already described.

60.9 c.c. of the gas residue from the above-mentioned electrolytically prepared chlorine * gave:

Oxygen	= 40.7	} and in per cent.	{	O ₂ = 66.9
Carbon monoxide	= 2.6			CO = 4.3
Nitrogen	= 17.6			N = 28.8
	60.9			100.0

At the carbon electrode (the anode) not only chlorine but also a small amount of oxygen is liberated. The latter attacks the carbon of the electrode, forming carbon monoxide, the greater part of which in turn combines with the chlorine, forming phosgene gas, COCl₂, but the latter is decomposed by water with the formation of CO₂ and HCl:

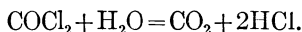

This accounts for the presence of the CO₂ and CO in chlorine which has been prepared electrolytically.

Hydrochloric Acid HCl. Mol. Wt. 36.47.

Density = 1.2686 (Air = 1). † Weight of one liter = 1.6400 gms.

Molar volume = 22.24 liters. Critical temperature = +52° C.

Hydrochloric acid is determined in gas mixtures by absorbing with standardized alkali.

* Consisting of 99.0 per cent. Cl₂ and 0.6 per cent. CO₂.

† Leduc, Compt. rend., **125**, 571 (1897), found the density of hydrogen to be 1.2692 and Busvold, Inaug. Dessert. Zurich, 1910, obtained the value 1.2680. The above figure is the mean of these two determinations.

Sulphur Dioxide, Mol. Wt. 64.07.

Density = 2.2639 (Air = 1).* Weight of one liter = 2.9267 gms.

Molar volume = 21.89 liters. Critical temperature = +155° C.

For the determination of sulphur dioxide from pyrite burners, F. Reich recommends that the gas should be sucked by means of an aspirator through a measured amount of $\frac{N}{10}$ iodine solution, colored blue with starch, until the latter is decolorized. The amount of the gas is equal to the quantity of water which has flowed from the aspirator + the volume of the absorbed SO₂.

For example, 10 c.c. of $\frac{N}{10}$ iodine solution were decolorized after V c.c. of water had flowed from the aspirator; the gas was at t° C. and 760 mm. pressure. Since in the absorption of the SO₂ by the iodine the following reaction takes place,

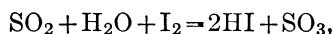

it is evident that the amount of SO₂ absorbed, measured dry at 0° and 760 mm. pressure, will be 10.95 c.c., for 1 c.c. $\frac{N}{10}$ iodine solution corresponds to 1.095 c.c. SO₂.

It follows, then, that the volume of gas taken for the analysis equals

$$\frac{V \cdot (B - w) \cdot 273}{760 \cdot (273 + t)} + 10.95 \text{ c.c.} = V_1,$$

and from this the per cent. of SO₂ in the gas can be calculated:

$$V_1 : 10.95 = 100x$$

$$x = \frac{1095}{V_1} = \text{per cent. SO}_2.$$

Other examples of gas analyses in which the absorbed constituent is estimated by titration are found in the determination

* Leduc, *Compt. rend.*, 117, 219 (1893).

of the hydrogen sulphide in gas mixtures (see below) and in the determination of carbonic acid in the atmosphere by the method of Pettenkofer (cf. p. 593).

Hydrogen Sulphide, H_2S ; Mol. Wt. = 34.09.

Density = 1.1895 (Air = 1).* Weight of one liter = 1.5378 gms.

Molar volume = 22.16 liters. Critical temperature = 100° C.

Determination of Hydrogen Sulphide in Gas Mixtures.

Hydrogen sulphide, when present in the gases escaping from mineral springs, is estimated as follows:

A large funnel, of from 2 to 3 liters capacity, is lowered into the spring and held in place by means of a wooden frame *B* weighted with stones, *s* (Fig. 125). The rubber tubing *d* is

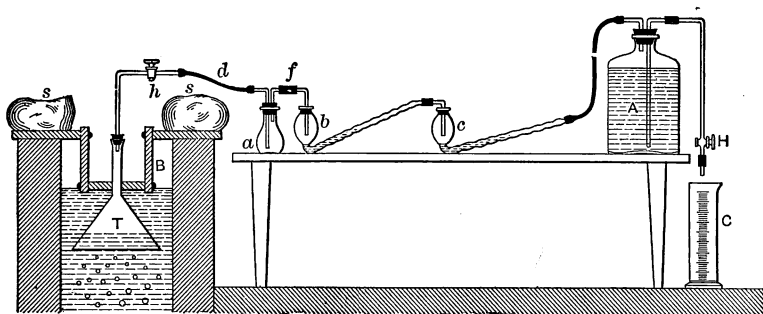

FIG. 125.

removed from the flask *a*, the stop-cock *h* is opened, and the funnel *T* is filled, by means of suction, with water up to the stopper, and then *h* is closed. As soon as the water in the funnel has been replaced by the ascending bubbles of gas, the flask *a* is connected on the one side with the stop-cock tube *h* and on the other side directly with the aspirator *A* by means of a long rubber tubing. Suction is then started by opening *H* and is

* Leduc. Compt. rend., 125, 571 (1897).

continued with h open until the water in the funnel T again reaches the stopper, when h is closed. The funnel is allowed to fill with gas again, and this is eventually removed through a by means of suction. This operation is repeated twice more. In this way the neck of the funnel, the glass tube h , the rubber tubing d , and the flask a , all have the air originally present in them replaced by gas from the spring; a few drops of water are carried along mechanically into a . Ten c.c. of hundredth-normal iodine solution are then introduced into the ten-bulb tube b and 10 c.c. of hundredth-normal thiosulphate solution are placed in the tube c . The flask a is now quickly connected with b by means of a short piece of rubber tubing f , and c is connected with the aspirator A by means of a longer piece of tubing. Meanwhile the funnel T is again filling with gas. A measuring cylinder C is placed under the outlet tube of the bottle A , H is opened, and then the stop-cock h is cautiously turned. The gas is allowed to bubble slowly through b until the iodine solution becomes light yellow, but is not decolorized. H is now closed and after about two minutes h also. The contents of c are poured into b , starch is added, and the excess of the thiosulphate is titrated with hundredth-normal iodine solution (cf. page 650). The number of cubic centimeters, n , of iodine required for the titration, represents the amount of iodine which reacted originally with the hydrogen sulphide. The position of the water in the graduate is noted (V c.c.), the temperature of the room t° , and the barometer reading B ; w is the tension of aqueous vapor at the temperature t° .

In computing the amount of hydrogen sulphide in the gases escaping from the spring, it is to be remembered that the volume of gas which is taken for the analysis is equal to the amount of water which has flowed into c plus the volume of hydrogen sulphide which has been absorbed by the iodine in b during the experiment. Inasmuch, however, as the amount of the latter is small in comparison with the total amount of gas taken for analysis, it may be neglected here. Furthermore, it is necessary to call attention to the fact that the volume of gas escaping from the spring is at a different temperature than that of the analysis; all the volumes, therefore, should be reduced to corre-

spond to the temperature at the spring. The amount of hydrogen sulphide present per liter in the spring gases at the temperature t° and the barometric pressure B is

$$308.4 \frac{n(273+t)}{V(B-w)} = \text{c.c. H}_2\text{S per liter.}^*$$

Determination of Ethylene, according to Haber.

The principle of this method was discussed on p. 752. The determination is effected in the Bunte burette (cf. p. 799, Fig. 122).

First, the contents of the lower portion of the burette from the lowest scale division to the cock is determined by weighing the water drawn from between these points, after allowing the burette to drain. Then about 90 c.c. of the gas to be examined are placed in the burette and the thermometer and barometer readings are taken. Then, exactly, as described on p. 799, the liquid is sucked down to the stop-cock, † a little bromine water is poured into a small evaporating-dish, about 10 c.c. of the liquid are allowed to rise into the burette, and in order to wash the bromine water from the tip into the burette, 2 or 3 c.c. of water are added.

The walls of the burette are now thoroughly wet with the bromine water by suitably turning and inclining the tube, and in this way the ethylene is quickly absorbed. In order to determine the excess of bromine, a strong solution of potassium iodide is allowed to rise into the burette, and the contents of the latter are vigorously shaken. The liquid is then run out into an Erlenmeyer flask, the burette is carefully washed out with water and the deposited iodine is titrated with $\frac{N}{10}$ sodium thiosulphate solution. The titre of the bromine water added is next determined by pouring a little into a porcelain dish,

* In this formula the temperature of the spring does not come into consideration because the gas is at the laboratory temperature when measured.

† After about one minute liquid will collect above the stop-cock, owing to the drainage of the liquid from the sides of the burette; this is removed before adding the bromine.

pipetting off 10 c.c. of it, allowing this amount to run into a solution of potassium iodide and titrating the liberated iodine with $\frac{N}{10}$ sodium thiosulphate solution.

The method of calculating the results will be illustrated best by means of a single example.

Example.—A gas consisting of 90 volumes of air and 10 volumes of ethylene was used for the analysis.

Taken for analysis, 91.2 c.c. of the mixture.

Temperature, 18.3° C.

Barometer reading, 725 mm.

Tension of aqueous vapor at 18.3° C. = 15.6 mm. mercury.

Volume of the ungraduated portion of the burette... 6.10 c.c.

Reading of the bromine water in the graduated part.. 10.00 "

Bromine water used..... 16.10 c.c.

Titre of the bromine water:

10 c.c. of the bromine water correspond to 12.0 c.c. $\frac{N}{10}$ sodium thiosulphate solution, so that 16.10 c.c. of bromine water are equivalent to 19.32 c.c. of $\frac{N}{10}$ sodium thiosulphate.

We have now:

16.1 c.c. bromine water..... = 19.32 c.c. $\frac{N}{10}$ solution.

16.1 c.c. bromine water + ethylene = 12.23 " " "

The ethylene corresponds to..... 7.09 " " "

Since the absorption of the ethylene by the bromine water takes place according to the equation

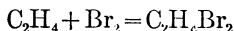

it follows that

2Br = 2I = 20.000 c.c. $\frac{N}{10}$ sodium thiosulphate solution = 22,270* c.c. ethylene, and since 1 c.c. $\frac{N}{10}$ sodium thiosulphate corresponds

* Cf. page 751.

to 1.100 c.c. C_2H_4 , the 7.09 c.c. of $\frac{N}{10}$ solution used represent $7.09 \times 1.100 = 7.94$ c.c. C_2H_4 at $0^\circ C.$ and 760 mm. pressure, or 9.10 c.c. C_2H_4 at $18.3^\circ C.$ and 725 mm., measured moist.

The gas consists, therefore, of:

$$\begin{array}{r} C_2H_4 = 9.1 \\ \text{Air} = 82.1 \\ \hline 91.2 \end{array} \left\} \text{ and in per cent. } \begin{array}{r} C_2H_4 = 10.0 \text{ per cent.} \\ \text{Air} = 90.0 \text{ " " } \\ \hline 100.0 \text{ per cent.} \end{array}$$

This method is especially suited for the determination of ethylene present with benzene in illuminating-gas. In one sample the sum of the two gases is determined by absorption with fuming sulphuric acid or bromine water, and in a second sample the ethylene is determined as described above.

This method is suitable for determining ethylene mixed with benzene vapors in illuminating gas. In one sample the sum of the two is obtained by absorbing with fuming sulphuric acid or bromine and in a second sample the ethylene is determined as above.

Remark.—Instead of using bromine water, which changes its strength so rapidly, the author uses a tenth-normal solution of potassium bromate; on acidifying an equivalent quantity of bromine is obtained.

The experiment is carried out as follows: Exactly as described above, 90 c.c. of the gas are led into the Bunte burette, the water withdrawn till the lower cock is reached, and then some potassium bromate solution is placed in a small porcelain dish and about 10 c.c. of it is sucked up into the burette and the volume determined. Then, after wiping off the lower capillary, an excess of concentrated potassium bromide solution and finally an excess of dilute hydrochloric acid is introduced. After shaking eight minutes, all the ethylene will be brominated. At the end of this time, 10 per cent. potassium iodide solution is allowed to enter the burette, the contents shaken, and emptied into an Erlenmeyer flask. The iodine thus liberated is titrated with tenth-normal sodium thiosulphate solution. The calculation is carried out as before. Using this modification of Haber's method, the author's

assistant, M. Bretschger, analyzed a mixture containing air and known quantities of ethylene with the following results:

	Ethylene taken.	Found.
1	5.20%	5.23%
2	5.20	5.16
3	5.20	5.15
4	3.90	3.88
5	3.70	3.70
6	3.70	3.68

Determination of Ethylene in the Presence of Acetylene.

Since acetylene is not attacked in the cold by either bromine or iodine, whereas ethylene is readily attacked, the author has caused his assistant to carry out a number of experiments in thus analyzing gas mixtures.

In one sample of the mixture, the sum of the ethylene-acetylene was determined by absorption with fuming sulphuric acid and in another sample the ethylene was determined by the above bromate-bromide method. The accuracy is attested by the following analyses of M. Bretschger:

Ethylene taken.	Ethylene found.	Acetylene found.
4.38%	4.33%	0.61%
4.17	4.23	0.32
9.96	9.71	0.35
9.83	9.84	0.43
7.85	7.73	4.65
7.83	7.82	4.60
2.69	2.80	19.18
2.64	2.74	19.60

GAS-VOLUMETRIC METHODS.

If in consequence of a chemical reaction a gas is evolved, from the volume of the latter the weight of the original substance may be determined.

Examples of this sort of an analysis were given under the determination of CO_2 in carbonates (pp. 384, 388, 393), the carbon contents of iron and steel (pp. 402 and 404), and the NO_3 in nitrates (p. 456).

At this place a few more important determinations of the same nature will be described.

Determination of Ammonia in Ammonium Salts.

The following method, first proposed by Knop* and later modified by P. Wagner,† depends upon the fact that ammonia is oxidized by sodium hypobromite with evolution of nitrogen:

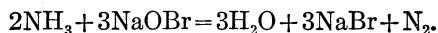

The nitrogen is collected in an azotometer and measured.

If the amount of the ammonia be calculated from the volume of the nitrogen, too low results will be obtained, and this fact was formerly explained by the assumption that a part of the nitrogen was absorbed as such by the alkaline bromine solution. To-day, however, we know that such is not the case. At ordinary temperatures all of the ammonia is not oxidized according to the above equation to water and nitrogen, but a small amount of ammonium hypobromite is formed; for this reason too little nitrogen is obtained in the azotometer. If, on the other hand, the decomposition takes place at 100°C ., the reaction goes quantitatively according to the equation. It is inconvenient to work at such a high temperature, so that it is more practical to make a correction to the volume of nitrogen obtained at ordinary temperatures.

* Chem. Centralbl., 1860, p. 243.

† Zeitschr. f. anal. Chem., XIII (1874), p. 383; XV (1876), p. 250.

Reagents and apparatus required:

1. An ammonium chloride solution, obtained by dissolving 8.3544 gms. of the pure sublimed salt in water and diluting to 500 c.c.

10 c.c. of this solution evolve at 0° C. and 760 mm. pressure 35 c.c. of nitrogen if the reaction takes place according to the equation.

2. Sodium hypobromite solution. 100 gms. of sodium hydroxide are dissolved in water, diluted to 1250 c.c. and after cooling by placing the flask in cold water, 25 c.c. of bromine are added, the contents of the flask vigorously shaken and again cooled.

This solution must be preserved in a stoppered bottle and protected from the action of light.

3. An azotometer. Instead of the azotometer of Wagner,* Lunge's Universal Apparatus (Fig. 61, b, p. 387), or any such measuring instrument may be used.

Procedure.—Ten c.c. of the standard ammonium chloride solution are placed in the small Wagner decomposition-bottle (Fig. 61, a, p. 387) while 40 to 50 c.c. of the hypobromite solution are poured into the glass *L* (which is fused to the bottom of the bottle *H*). The bottle is then connected with the measuring-tube *A*,† which is entirely filled with mercury, *b* opened and the levelling-tube *B* lowered. The bottle *H* is inclined so that some of the hypobromite solution comes in contact with the solution of ammonium chloride and the two liquids are mixed by gentle shaking. A lively evolution of nitrogen at once takes place and the liquid becomes heated. As soon as the action ceases, more of the hypobromite solution is allowed to act upon the ammonium salt and the process is repeated until finally all of the hypobromite is in the outer part of *H*. As soon as no more gas is evolved by shaking, the decomposition-bottle is placed in water at the room temperature and after allowing it to stand ten minutes, the volume of the nitrogen is read under the conditions described on p. 389. The volume of nitrogen at 0° and 760 mm.

* *Loc. cit.*

† The contents of the decomposition-bottle are previously cooled to the room temperature before the cock *b* is connected with it.

thus found will be smaller than the theoretical value of 35 c.c., but it corresponds to the amount of ammonia contained in 10 c.c. of the ammonium chloride solution, i.e., 0.05320 gm. NH_3 .

A number of such determinations are carried out and the mean of the results obtained is taken for the correct value.

After this, some of the ammonium salt to be analyzed is weighed out, dissolved in water, and diluted so that 10 c.c. of the solution will contain approximately the same amount of ammonia as in the case of the standard solution. Then if, for example, from a gms. of an ammonium salt, V c.c. of nitrogen at 0°C . and 760 mm. pressure were found, we have:

$$V : V = 0.05320 : x$$

$$x = \frac{V_1 \times 0.05320}{V}$$

and in per cent.:

$$\frac{V_1 \times 5.320}{V \cdot a} = \text{per cent. } \text{NH}_3.*$$

Remark.—The results obtained by this method agree exactly with those obtained by the distillation method described on p. 560. Only with substances containing sulphocyanates are the results obtained too high; in this case the sulphocyanate is decomposed by the alkaline hypobromite solution with evolution of nitrogen and carbon monoxide.†

Consequently, the above method affords uncertain results in the analysis of the ammonia in gas liquors.

Urea is decomposed by the alkaline hypobromite solution according to the equation:

* Lunge (Lunge-Berl, Chem. techn. Untersuchungsmethoden, 6th edition, Vol. I, p. 155) does not standardize against the solution of ammonium chloride of known strength, but adds 2.2 per cent. more ammonia to correspond to the loss of nitrogen. Then $V \times 0.001558 = \text{gm. ammonia}$.

† Donath and Pollak, Zeitschr. f. angew. Chem., 1897, p. 555.



so that it can be determined in the same way as ammonium salts, the carbon dioxide produced by the decomposition being kept back by means of caustic soda solution.

Determination of Nitrous and Nitric Acids.

Principle.—If a solution of a nitrite or nitrate be shaken with mercury and an excess of sulphuric acid, all of the nitrogen is set free as nitric oxide:

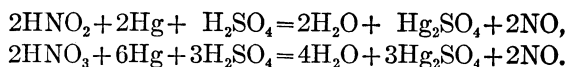

From the volume of the nitric oxide, the weight of the nitrate or nitrite is computed.

The analysis is best performed in a Lunge nitrometer.† The latter is a Bunte burette, in which the lower stop-cock is lacking and the lower end of which is connected with a levelling-tube containing mercury. By raising the latter, the nitrometer (which need not be graduated) is entirely filled with mercury and the two-way cock under the funnel is closed. Then a weighed amount of the substance dissolved in a little water is placed in the funnel, the levelling-tube lowered, and the solution introduced into the nitrometer by carefully opening the cock, the funnel being finally washed out four times with two or three c.c. of concentrated sulphuric acid. The decomposition-tube is now taken out of the frame, it is placed several times in a nearly horizontal position and then quickly changed to a vertical position. By this means the mercury becomes intimately mixed with the acid and the decomposition at once begins. The shaking is continued one or two minutes until there seems to be no further increase in the volume of the liberated gas. The decomposition vessel is then

* This reaction does not take place as completely as with ammonium salts. Lunge finds in the determination of urea in urine that the nitrogen deficit is 9 per cent. If, therefore, the volume of nitrogen after being reduced to 0° and 760 mm. is multiplied by 2.952, the correct urea value is obtained.

† Berichte, 1890, p. 440, and Zeitschr. f. angew. Chem., 1890, p. 139.

‡ See also Lunge-Berl, Chem. techn. Untersuchungsmethoden, 6th edition, Vol. I, p. 156.

connected by means of a short piece of rubber tubing with the gas-burette filled with mercury, the nitric oxide is transferred to the latter, and its volume read after reducing it to the standard conditions by means of the gas-compensation tube. (Cf. p. 387, Fig. 61, b.)

If in an analysis a gms. of a nitrate were taken and V_0 c.c. of NO were obtained, we have:

$$\begin{aligned} & \text{(NO}_2\text{)} \\ 22,391 \text{ c.c.} : 62.01 &= V_0 : x \\ x &= \frac{V_0 \times 62.01}{22391} \text{ gms. NO}_3 \end{aligned}$$

and in per cent.:

$$\frac{6201}{22391} \times \frac{V_0}{a} = 0.2769 \times \frac{V_0}{a} = \text{per cent. NO}_3.$$

Remark.—For the analysis of “nitrose,”* the author knows of no method which affords such exact results.

For the determination of nitrous acid in the presence of nitric acid by a gas-volumetric method, P. Gerlinger† treats the neutral solution of the two salts with a concentrated solution of ammonium chloride, whereby the following reaction takes place:

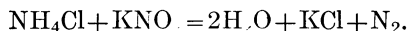

Half of the nitrogen evolved, therefore, comes from the nitrous acid present. For the details of this determination, the original article should be consulted.

Hydrogen Peroxide Methods.

Hydrogen peroxide in many cases acts as an *oxidizing* agent, and in other cases it has a marked *reducing* action.

† This anomalous behavior can be explained very easily by assuming that one of the oxygen atoms in hydrogen peroxide has an equal number of positive and negative charges or valence bonds.

When hydrogen peroxide decomposes spontaneously on standing, a reaction which is often aided by shaking with an inert substance, such as sand, this neutral oxygen atom is lost and oxygen molecules are formed. When hydrogen peroxide acts as an *oxidizing agent*, this neutral oxygen atom is reduced to its

* Cf. Vol. I. † Z. angew. Chem., 1901, 1250. See also J. Gaihlot, J. Pharm. Chim., 1900, 6th Series, Vol. XII, p. 9.

normal negative valence of two. When hydrogen peroxide acts as a *reducing agent*, gaseous oxygen is always one of the products of the reaction. It is usually assumed that half of the evolved oxygen comes from the oxidizing agent and half from the hydrogen peroxide. Thus

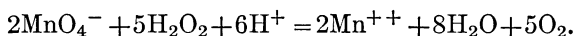

In the two following methods which involve the use of hydrogen peroxide, a large excess of the peroxide should not be used and long-continued shaking should be avoided.

(a) Standardization of Permanganate Solutions.

The determination is best made according to Lunge in a gas volumeter (p. 387, Fig. 61). In order to obtain correct results, however, it is absolutely necessary that no excess of hydrogen peroxide be present. Consequently it is necessary to determine by means of a preliminary experiment the exact value of the permanganate solution in terms of the H_2O_2 solution used (cf. p. 626). Then a measured amount of the latter is placed in the outside part of the Wagner decomposition-bottle (Fig. 61a, p. 387), and 30 c.c. of dilute sulphuric acid (1:5) are added. After this, the exact amount of hydrogen peroxide required for the decomposition of the permanganate is introduced into the inner part of the bottle and the latter is connected with the measuring-tube, which is filled with mercury, the cock *b* being removed for the time being, but it is replaced at the end of two or three minutes and turned to the position shown in the figure.

The two liquids are then mixed, taking care to hold the decomposition-flask so that its contents will not be warmed by the heat of the hand, inclining it to an angle of about 90° with the vertical, and shaking for exactly one minute. While the oxygen is being evolved, care must be taken that the gas in the eudiometer is under reduced pressure. At the end of the decomposition, the gas is placed under atmospheric pressure, *b* is closed, and by means of the compensation-tube, the volume of the gas is reduced to what it would be at 0° C. and 760 mm. pressure, as described on p. 388.

One-half of the observed volume corresponds to the amount of oxygen given up by the potassium permanganate. This number multiplied by 0.001429 gives the *weight* of the oxygen obtained from the permanganate.

Remark.—The amount of permanganate to be taken for the experiment is determined by the size of the measuring-tube. If the latter has a capacity of 150 c.c., 15 c.c. of a $\frac{N}{5}$ solution or 40 to 50 c.c. of a $\frac{N}{10}$ solution should be taken.

The hydrogen peroxide used should not be too concentrated; it should be about a 2 per cent. solution. The active oxygen present in a sample of pyrolusite* may be determined by the same procedure.

(b) Determination of Cerium in Soluble Ceric Salts.

If hydrogen peroxide is added to an acid solution of a soluble ceric salt, the latter is reduced with evolution of oxygen:

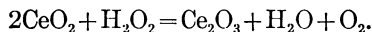

The determination is effected in precisely the same way as was described above in the standardization of the permanganate solution. If half the volume of liberated oxygen is multiplied by 0.03077, the product represents the corresponding amount of CeO_2 .†

Remark.—If a large excess of hydrogen peroxide is avoided in the above analysis, satisfactory results will be obtained.

For other determinations of this sort, consult "Lunge's Alkali Makers' Handbook" and "Hempel's Gas-Analytical Methods."

Silicon Fluoride, SiF_4 . Mol. Wt. = 104.3.

Density = 3.605 (Air = 1). Weight of one liter = 4.650 gms.

Molar volume = 22.40 liters.

* Lunge's Alkali Makers' Handbook.

† Assuming that the atomic weight of Ce = 140.25.

Determination of Fluorine as Silicon Fluoride (Hempel and Oettel).*

Principle.—If a mixture of calcium fluoride and powdered quartz is treated with concentrated sulphuric acid in a glass vessel, all of the fluorine will be expelled as silicon fluoride:

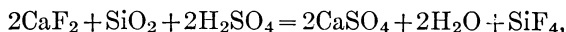

and this gas can be collected and measured.

One c.c. SiF_4 at 0° and 760 mm. pressure corresponds to 0.006978 gms. CaF_2 , or 0.003395 gms. F_2 .

Procedure.—A weighed amount of the very finely-powdered substance, which must not contain any other acid that can be expelled by treatment with concentrated sulphuric acid,† is mixed with 3 gms. of ignited finely-powdered quartz and introduced into the *dry* decomposition flask *K* (Fig. 126). The latter is then evacuated somewhat by twice lowering the leveling-tube *N* with the stop-cock *H* open, closing the cock and expelling the air. At the beginning of the experiment, the burette *H* is not connected with the Orsat tube *O*. By raising the ground-glass tube *R*, about 30 c.c. of concentrated sulphuric acid are allowed to flow into the flask. This acid must have been previously heated in a porcelain crucible for some time at a temperature near the boiling-point, in order to destroy every trace of organic matter, and allowed to cool in a desiccator over phosphorus pentoxide. The acid in *K* is heated to boiling with the stop-cock *H* open and the flask is frequently shaken. During the entire experiment, the mercury level in the tube *N* is kept a little lower than that of the mercury in the measuring-tube *M*.‡

At first the sulphuric acid foams considerably, but soon ceases, which is a sure sign that the decomposition is complete. The flame is then removed, the sulphuric acid allowed to cool and all the gas in *K* is expelled by introducing through *V* sulphuric

* Gasanalytische Methoden, III, p. 342.

† Cf. p. 479.

‡ In order to keep the inside of *N* perfectly dry, 2 or 3 c.c. of concentrated sulphuric acid are placed on top of the mercury.

acid, which has been previously heated and cooled as described above. As soon as the sulphuric acid reaches the stop-cock *H*, this is closed. After waiting ten minutes more, the gas is placed under atmospheric pressure, by suitably raising *N*, and the volume and temperature are noted.

The gas is now driven over into the Orsat tube *O*, containing caustic potash solution (1:2). The silicon tetrafluoride is immediately absorbed. The residual gas is carried back to the tube *M*, and after waiting fifteen minutes the volume is read. The differ-

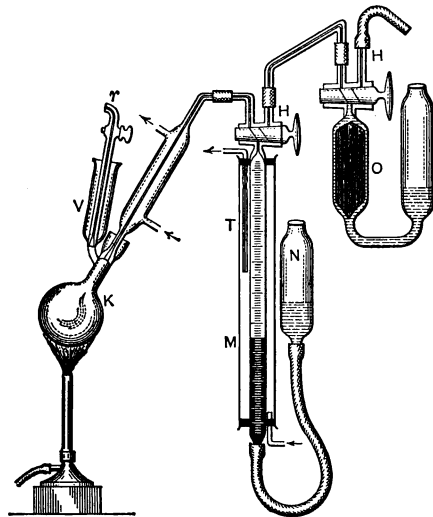

FIG. 126.

ence between the two readings gives the volume of silicon tetrafluoride.

Remarks.—A. Koch tested this method in the author's laboratory and obtained results varying from 98.97 to 102.63 per cent. with pure calcium fluoride. To obtain this accuracy, however, it is necessary to carry out the decomposition under approximately atmospheric pressure. When working under a vacuum the results were always too low. Thus in one case only 85.70 per cent. of the theoretical value was obtained.

During these experiments with reduced pressure, a white sublimate forms at the lower part of the condenser, which on coming in contact with the sulphuric acid that is introduced at

the last, causes a strong effervescence. Since, however, all the gas in the burette was replaced, we believed that the low results could be traced to the absorption of silicon fluoride by the sulphuric acid. This idea proved to be false, for a measured volume of silicon fluoride does not change when allowed to stand for twenty-four hours over concentrated sulphuric acid. The error, therefore, must be caused by the strange deposit that has condensed in the lower part of the condenser. If the work is carried out under atmospheric pressure as described above, the white deposit is never obtained.

The method can be used for the estimation of fluorine in the presence of carbonates. In this case the silicon fluoride is absorbed by means of a little water and the carbon dioxide by means of caustic potash. As, however, a little of the carbon dioxide is dissolved by the water, the gas residue which has been freed from carbon dioxide is shaken with this water again, whereby this dissolved carbon dioxide is removed and can be absorbed by a further treatment with caustic potash solution. For further details, consult the original paper by Hempel and Scheffler.*

Determination of Vapor in Gas Mixtures.

It is often desired to estimate the weight, and from this the volume, of vapor present in a mixture of gases and vapors. This will be illustrated by one or two examples. Let it be assumed that in a unit of volume of a given gas mixture there are v' parts of gas and v'' of vapor. If the whole mixture is under the pressure P , then the *partial pressures* of the gas and vapor will be respectively $v'P$ and $v''P$. The following equation then holds:

$$P = v'P + v''P.$$

The total pressure is therefore equal to the sum of the partial pressures.

If now the partial pressure of either constituent is known, the volume of this constituent can be found by dividing by the total pressure. If, for example, $v''P = w$, then

$$\frac{v''P}{P} = \frac{w}{P} = v''.$$

Applications.—1. *Reduction of Volumes of Moist Gases to a Dry Condition at 0° C. and 760 mm. Pressure.*

* Z. anorg. Chem., 20, 1 (1897).

A gas saturated with water vapor occupies a volume v_t at t° C. and P mm. pressure. A unit of volume of the gas consists of v' volumes of dry gas and v'' volumes of water-vapor. Now the tension of aqueous vapor at $t^\circ = w$, a value which can be obtained from the tables on p. 842. This value, w , represents in fact the partial pressure of the water-vapor. Consequently $P - w$ is the partial pressure of the dry constituents and the volume of the latter, v' , is, as explained above:

$$v' = \frac{P - w}{P} \text{ at } t^\circ \text{ and } P \text{ mm. pressure.}$$

This volume reduced to 0° and 760 mm. pressure is

$$v'_0 = \frac{(P - w)P}{P \cdot 760 \cdot (1 + \alpha t)} = \frac{P - w}{760(1 + \alpha t)}.$$

If the original volume of the gas and vapor is not 1, but V_t , then,

$$V'_0 = \frac{P - w}{760(1 + \alpha t)} \cdot V_t.$$

Similarly, the volume of the water-vapor at 0° and 760 mm. pressure is

$$V''_0 = \frac{w}{760(1 + \alpha t)} \cdot V_t.*$$

2. Calculation of the Moisture in the Air at Normal Pressure (760 mm.) and Temperature t° .

What is the volume of water-vapor contained in 100 c.c. of moist air at 0° , 25° , and 35° C.? According to the table: $w_0 = 4.6$ mm.; $w_{25} = 23.5$ mm.; and $w_{35} = 41.8$ mm. Hence the volume of water-vapor present in a unit of volume is

$$\frac{w_0}{760} = \frac{4.6}{760}; \quad \frac{w_{25}}{760} = \frac{23.5}{760}; \quad \frac{w_{35}}{760} = \frac{41.8}{760}.$$

* In this formula is it assumed that the water-vapor also follows Boyle's law, which is not strictly true.

and the percentage of moisture is

0.61	per cent	at	0°;
3.09	“	“	25°;
5.50	“	“	35°.

If the gas is not saturated with moisture, the relation of the dry gas to the moist one is not so easy to determine, unless the degree of saturation is known. The humidity of a gas, or the degree of saturation, expresses the amount of moisture present as compared with the total amount which the gas can take up when perfectly saturated with moisture. Thus if the humidity is 50 per cent. the gas could take up as much again moisture at the prevailing temperature.

If the degree of humidity of a gas is expressed by r , then the volume of the given gas at this temperature and 760 mm. pressure, is

$$\frac{V(P-r \cdot w)}{760},$$

and the volume of the water-vapor present is

$$\frac{V \cdot r \cdot w}{760}.$$

3. *Calculation of the Weight of Water-vapor in a Given Volume of Air which is Saturated with Moisture at the Temperature t° and the Pressure P mm.*

One c.c. of water-vapor weighs 0.000801 gm. at 0° C. and 760 mm. pressure.

One c.c. of water-vapor at t° and P mm. pressure occupies a volume of

$$v_0 = \frac{1 \cdot P}{760(1 + \alpha t)},$$

and weighs

$$\frac{P}{760(1 + \alpha t)} = 0.000801 \text{ gm.}$$

If now $w =$ the vapor pressure of water at t° and P mm.

pressure, then the volume of water-vapor present in the volume V of the gas is, under these conditions,

$$\frac{w \cdot V_t}{P},$$

and the weight of the water-vapor amounts to

$$\frac{P}{760(1+\alpha t)} \cdot 0.000801 \cdot \frac{w \cdot v_t}{P} = \frac{0.000801 \cdot w \cdot v_t}{760(1+\alpha t)} \text{ gms.}$$

If the weight of the water-vapor is g , then the volume of the moist air is

$$v_t = \frac{g \cdot 760(1+\alpha t)}{0.000801 \cdot w}.*$$

If the gas is not saturated with water vapor, but the degree of saturation (the humidity) is known, then the following formula gives the weight of water-vapor present in the volume v_t of the gas,

$$g = \frac{0.000801 \cdot r \cdot w \cdot v_t}{760(1+\alpha t)} \text{ gms.}$$

Or, if the weight of vapor present in a given gas volume is known, then from the last equation the humidity, r , of gas may be computed:

$$r = \frac{g \cdot 760(1+\alpha t)}{0.000801 \cdot w \cdot v_t}.$$

4. *Calculation of the Weight of One Liter of Air at 0° and 760 mm. when Free from Moisture and Carbon Dioxide.*

1 c.c. of pure, dry air weighs 0.0012928 gm. at 0° and 760 mm.
 1 cc. of water-vapor weighs 0.000801 gm. at 0° and 760 mm.
 1 cc. of water-vapor is therefore 0.62 times as heavy as 1 c.c. of air
 1 c.c. of CO₂ weighs 0.001977 gm. at 0° and 760 mm.

* Similarly, the volume of a gas saturated with any other vapor can be computed if the weight of vapor present and its density are known.

Air contains, on an average, 0.03 per cent of CO₂. One liter of dry air, containing the average amount of CO₂ consists of

999.7 c.c. air	and weighs	999.7 × 0.001293 = 1.2924 gms.
0.3 " CO ₂		0.3 × 0.001977 = 0.0006 "
1000.0 "		1.2930 " = a

The corresponding volume of dry air and of water-vapor at 0° and 760° mm. pressure is

$$\frac{760-w}{760} + \frac{w}{760}$$

and weighs

$$\frac{760-w}{760} \cdot a + \frac{w}{760} \cdot 0.62a = a \left(1 - \frac{0.38w}{760} \right),$$

or, in other words, 1 liter of moist air weighs at 0° and 760 mm. pressure,

$$g = 1.293 \left(1 - \frac{0.38w}{760} \right) \text{ gms.}$$

5. Calculation of the Weights of One Liter of Moist Air Containing Carbon Dioxide at t° and P mm. Pressure.

If the tension of aqueous vapor = w_t , then the volume of the moist gas is

$$\frac{w_t}{P} + \frac{P-w_t}{P} = 1 \text{ at } t^\circ \text{ and } P \text{ mm. pressure,}$$

and at 0° and 760 mm.

$$\frac{w_t}{760(1+\alpha t)} + \frac{760-w_t}{760(1+\alpha t)},$$

and, as shown under 4, this weight,

$$g = \frac{P-w}{760(1+\alpha t)} \times a + \frac{w}{760(1+\alpha t)} \times a \times 0.62 = \frac{a(P-0.38w)}{760(1+\alpha t)} \text{ gms.}$$

or

$\frac{0.46445(P-0.38w)}{273+t}$ = the weight of 1 liter of moist air at t° and
 P mm. pressure.

V liters of moist air would therefore weigh:

$$g' = \frac{0.46445(P-0.38w)}{273+t} v.$$

APPENDIX I.*

The Influence of Fine Grinding on Composition.

THE rate at which a substance dissolves increases as the amount of surface exposed to the solvent is increased and for this reason solid substances always dissolve more quickly when reduced to a fine powder. Moreover, when a material undergoes chemical attack an insoluble substance is often formed and, during the process of solution, the insoluble substance may form a protective coating over particles of material that have been unacted upon. This danger is diminished if the material is in the form of a fine powder. For these reasons the chemist usually prefers to grind a solid substance to an impalpable condition before attempting to analyze it.

This practice, while desirable in most cases and absolutely necessary in others, is accompanied by certain disadvantages. If the material is hard there is always some contamination from the material of which the grinding apparatus is constructed. Thus when the sample is ground in a steel mortar or in a steel ball-mill, it will be contaminated with a little iron and if ground in an agate mortar with a little silica.† Again, if the sample readily undergoes slight decomposition, such a chemical change is likely to take place during the operation of grinding. In this way the determination of moisture, of ferrous iron, and of sulphur may be influenced very appreciably.

* The material in this appendix is added temporarily in this form at a time when the book is out of print and there is not time to get out a complete new edition. It will be introduced eventually into the main portion of the book. (Editor.)

† Hempel (*Z. angew. Chem.*, 1901, 843) found that an agate mortar and pestle lost 0.052 gm. in grinding 10 gms. of glass to a fine powder.

A number of investigators have pointed out the effect of grinding upon the moisture content of a sample. If the sample is practically dry, it is likely to absorb considerable moisture when dried in the air. Thus Hillebrand * found that a piece of unglazed porcelain contained no moisture originally, but showed 0.62 per cent. of water when ground. If the substance is very hygroscopic, this danger becomes greater. On the other hand, grinding often causes loss of moisture. This is notably true in the case of substances containing water of crystallization or superficial moisture. Thus grinding can easily reduce the moisture content of a sample of gypsum from twenty to five per cent, and a sample of coal may show several per cent of moisture when large lumps of it are tested and very little moisture after it is reduced to a fine powder.

The heat produced by grinding may not only serve to expel moisture from the sample, but it may cause chemical change. Thus Mauzelius † has shown, and the experiment has been repeated by Hillebrand, ‡ that the ferrous iron content of a rock becomes smaller on account of grinding it to a fine powder. It has also been found that some sulphur may be lost by long grinding of a sample of pyrite.

The effect of grinding, therefore, accounts for many cases of divergent results obtained in the hands of different chemists who have analyzed the same original material.

The Use of Cupferron in Quantitative Analysis.

Cupferron, $C_6H_5-N-N-OH_4$, is a short name for the

$$\begin{array}{c} \text{O} \\ || \\ \text{O} \end{array}$$
 ammonium salt of nitrosophenyl hydroxylamine. O. Baudisch § first suggested its use as a reagent for the quantitative precipitation of cupric and ferric ions. By means of cupferron, it is

* The Analysis of Silicate and Carbonate Rocks, Bull. 422, U. S. Geol. Survey.

† Sveriger Geol. Undersökning, Årsbok 1 (1907).

‡ J. Am. Chem. Soc., 30, 1120 (1908).

§ O. Baudisch, Chem.-Ztg., 33, 1298 (1909); Baudisch and King, J. Ind. Eng. Chem., 3, 629 (1911).

possible to precipitate quantitatively copper, iron and titanium from strongly acid solutions and in this way a number of separations may be accomplished which otherwise involve considerable difficulty. The copper salt is gray, the ferric salt red and the titanium salt yellow.

As a precipitant for copper, the reagent apparently offers no special advantages, and when silver, lead, mercury, tin or bismuth are present, these elements contaminate the precipitate to some extent. On the other hand, in the case of iron and titanium it is very useful to possess a reagent which will precipitate these elements quantitatively from acid solutions without contamination from aluminium, chromium, manganese, nickel, cobalt, zinc or alkaline earth metal. Titanium, zirconium and thorium are also precipitated by cupferron.* The advantages of cupferron for effecting separations has been pointed out by a number of chemists.†

Cupferron is readily soluble in water and the ammoniacal solution keeps well. The reagent is not very stable in acid solutions, particularly in hot solution or when an oxidizing agent is present. By oxidation, nitrosobenzene is formed and its presence can be detected by the peculiar, sweetish odor in nearly every precipitation with cupferron. When much nitrosobenzene is formed it separates out in the form of white needles. Precipitation with cupferron is always effected in cold, acid solution and an excess of the reagent must be used. The precipitate is stable as long as an excess of cupferron is present.

When iron and copper are precipitated together by means of cupferron, washing with ammonia serves to remove the copper and the excess of cupferron; it also serves to convert the iron precipitate into ferric hydroxide, in which form it is more readily converted into ferric oxide on ignition. In the ammoniacal solution of the copper precipitate, the copper is again precipitated upon the addition of acetic acid and by washing with one per

* Schroeder, *Z. anorg. Chem.*, **72**, 89 (1911).

† Nissenson, *Z. angew. Chem.*, **23**, 969 (1910); Biltz and Hodtke, *Z. anorg. Chem.*, **66**, 426 (1910); Hanus and Soukup, *ibid.*, **68**, 52 (1910); R. Fresenius, *Z. anal. Chem.*, **50**, 35 (1911); Bellucci and Grassi, *Gazz. chim. ital.*, **43**, I, 570; Thornton, *Am. J. Sci.*, **37**, 173 and 407 (1914).

cent. sodium carbonate solution the cupferron may be removed from the copper.

The manner of preparing the reagent and four methods illustrating its use will be described.

Preparation of Cupferron.*

Cupferron is prepared from β -phenylhydroxylamine, ammonia and amyl nitrite.

Preparation of β -Phenylhydroxylamine.—Place 8 liters of water, 500 gms. of nitrobenzene and 250 gms. of ammonium chloride in a 4-gallon earthenware jar. Stir the mixture rapidly to an emulsion by means of an efficient mechanical stirrer and, while still stirring, sift into the mixture 670 gms. of zinc dust (75 to 80 per cent. Zn) during the course of fifteen to twenty minutes. To obtain a good product it is advisable to keep the temperature below 20° by the addition of shaved ice.

After the zinc dust has been added, continue stirring for about fifteen minutes when the end of the reaction is indicated by the fact that the temperature of the mixture no longer rises. Continue stirring another five minutes and then filter off the insoluble zinc oxide with the aid of suction and wash with about one liter of water. Saturate the filtrate with sodium chloride and cool to nearly 0°. Filter with the aid of suction and dry between filter papers.

As phenylhydroxylamine solutions are active skin poisons, the hands and face should be washed with water and then with alcohol in case any solution spatters on them.

Preparation of Cupferron.—Weigh the moist crystals obtained by the above process and dissolve them in three liters of ordinary ether. Filter through a dry filter into a 5-liter round-bottomed flask. Weigh the insoluble residue (sodium chloride) to determine the quantity of dissolved β -phenylhydroxylamine. The flask should be fitted with a mechanical stirrer and be immersed in an ice-salt bath. When the temperature has fallen to 0° pass a rapid stream of dry ammonia gas through the solution. After about fifteen minutes add the theoretical quantity of freshly-

* Marvel and Kamm, J. Am. Chem. Soc., 41, 276 (1919); cf. Baudisch, loc. cit.

distilled amyl nitrate (107 gms. per 100 gms. of β -phenylhydroxylamine) slowly through a dropping funnel. The addition of amyl nitrate usually requires about thirty minutes, during which time the stream of ammonia gas should be continued in order to make sure that an excess of ammonia is always present. If this precaution is not observed, a colored product will result. The temperature of the reaction mixture should be maintained below 10° ; this is controlled best by the rate of adding the amyl nitrite.

After all the amyl nitrite has been added, continue stirring about ten minutes longer to insure completion of the reaction. Filter off the cupferron and wash several times with small portions of fresh ether. Spread on sheets of filter paper until all ether is volatilized. Keep a closely-stoppered bottle, containing a small lump of ammonium carbonate placed upon a doubled sheet of filter paper, on top of the cupferron.

1. THE DETERMINATION OF IRON IN MANGANESE ORES.

Principle.—After effecting the solution of the ore, the iron is precipitated in acid solution by cupferron. The filtrate then contains all the aluminium, chromium, manganese, nickel, cobalt, zinc and alkaline earths. After the removal of any of these elements that may be present, by washing the precipitate with cold water, the organic matter is removed and the iron converted into ferric hydroxide by washing the precipitate with ammonia, and the iron is weighed as Fe_2O_3 .

Procedure.—About 1 gm. of the finely pulverized ore is dissolved in concentrated hydrochloric acid, sp. gr. 1.2, and the solution evaporated to dryness. The residue is moistened with strong hydrochloric acid, the solution diluted with water, boiled and filtered. The residue is fused with sodium carbonate in a covered platinum crucible, and after the fusion, the melt is taken up in water and hydrochloric acid. The solution is evaporated to dryness, and after the removal of the silica in the usual manner, the filtrate is added to the main solution. The cold solution is then treated with a solution of about 3 gms. cupferron in 50 c.c. of cold water, added in a fine stream down

the sides of the beaker while the solution is being vigorously stirred. A brownish red, partly amorphous and partly crystalline precipitate of the ferric salt separates out. As soon as a drop of the reagent causes the formation of a snow-white precipitate of nitrosophenylhydroxylamine, all the iron is precipitated. A slight excess of the reagent is added and the solution allowed to stand about 10 minutes, after which it is filtered through an ashless paper, using gentle suction. In case the last particles of the precipitate cling tenaciously to the beaker, a little ether is added to loosen them and the ether removed by adding a little boiling water. The precipitate is now washed with cold water until the washings are no longer acid to litmus and then with ammonia (sp. gr. 0.96) to remove the excess of the reagent and form ferric hydroxide. The filter is finally washed once more with cold water. The precipitate is ignited carefully with the filter, avoiding reduction, and weighed as Fe_2O_3 .

Remark.—Following this procedure, R. Fresenius * obtained the values 18.23 per cent., 18.56 per cent., and 18.03 per cent. Fe in the analysis of three manganese ores which when analyzed volumetrically for iron, showed respectively, 18.25 per cent., 18.49 per cent., and 17.93 per cent. Fe. The manganese may be determined in the filtrate.

2. THE DETERMINATION OF MANGANESE IN FERRO-MANGANESE.

About one gram of the material is dissolved in strong hydrochloric acid and the residue is fused with sodium carbonate in a platinum crucible. The product of the fusion is extracted with water and alcohol is added to reduce the manganate, formed by the fusion, to hydrated manganese dioxide. The aqueous extract from the fusion is filtered, the residue is dissolved in hydrochloric acid, and the solution added to that obtained in the first place. The iron is precipitated with cupferron, as in the previous method, but it is not advisable to add the ammonia washings to the solution on account of the organic material they contain. In the filtrate the manganese is precipitated as described on page 122 and determined as sulphide according to page 125.

Remark.—In testing this method R. Fresenius * obtained

* Z. anal. Chem., 50, 35 (1911).

duplicate values of 81.04 and 81.01 per cent. Mn as compared with 81.01 and 81.17 by the basic acetate method. The cupferron method is much shorter and easier to carry out.

3. THE DETERMINATION OF NICKEL AND COBALT IN ARSENICAL SULPHIDE ORES.*

One gram of the sample is dissolved in concentrated hydrochloric acid, which is saturated with bromine, and the solution evaporated somewhat to volatilize arsenic. Ten cubic centimeters of sulphuric acid (1 : 1) are added and the solution evaporated until dense fumes are evolved. The solution is diluted, heated to boiling, and hydrogen sulphide is introduced to precipitate the metals of the copper group and any remaining arsenic. In the filtrate the iron is precipitated by cupferron as in Method 1, and after evaporating the filtrate until fumes of sulphuric acid are evolved, the nickel and cobalt are determined electrolytically according to page 136.

In case it is desired to determine the arsenic as well, the ore is dissolved in 15 c.c. of concentrated sulphuric acid, and the arsenic is precipitated as sulphide by passing hydrogen sulphide into the hot solution. The arsenic is separated from copper according to page 235 by means of alkaline sulphide, the arsenic sulphide precipitated in the filtrate upon making it acid, the arsenic sulphide dissolved in concentrated hydrochloric acid and potassium chlorate, and the arsenic determined as magnesium pyroarsenate according to page 206.

4. THE DETERMINATION OF TITANIUM AND ITS SEPARATION FROM IRON, ALUMINIUM AND PHOSPHORIC ACID.†

Principle.—The iron may be reduced completely to ferrous salt by passing hydrogen sulphide into an acid solution, and then, in the presence of tartaric acid which prevents the precipitation of titanium, precipitated as ferrous sulphide in ammoniacal solution. After acidifying and boiling off the hydrogen

* H. Nissenson, *Z. angew. Chem.*, **23**, 969 (1910).

† W. M. Thornton, Jr., *Am. J. Science*, **37**, 407 (1914).

sulphide, the titanium can be precipitated quantitatively by means of cupferron while the aluminium and phosphoric acid remain in the tartaric acid solution. It is unnecessary to remove the organic matter before igniting the yellow titanium precipitate.

Procedure.—To the solution, which should have a volume not greater than 100 c.c., at least four times as much tartaric acid is added as corresponds to the weight of the oxides of iron, titanium, aluminium, and phosphorus. The solution is neutralized with ammonia, acidified with 3 c.c. of sulphuric acid (1 : 1) and hydrogen sulphide is introduced until the solution becomes colorless. Unless the iron is all reduced, the subsequent precipitate of iron sulphide will contain some titanium. Ammonium hydroxide is now added in considerable excess and the iron is completely precipitated as ferrous sulphide by introducing more hydrogen sulphide gas; the solution should remain alkaline to litmus paper. The ferrous sulphide is filtered off and washed with water containing a little colorless ammonium sulphide. To the filtrate, 40 c.c. of H_2SO_4 (1 : 1) are added and the liberated hydrogen sulphide is expelled by boiling. When this is accomplished, the solution is cooled to room temperature, diluted to 400 c.c., and treated with an excess of 6 per cent. cupferron solution, which is added slowly down the sides of the beaker while the solution is being well stirred. After the precipitate has subsided, the supernatant liquid is tested by adding more of the cupferron solution. A white precipitate of nitroso-phenylhydroxylamine indicates that an excess of the reagent is present but a yellow turbidity shows that the precipitation of the titanium is incomplete. It is also well to test the filtrate in the same way. The precipitate of the titanium precipitate is collected on filter paper, using gentle suction, and washed twenty times with normal hydrochloric acid solution. The precipitate is then ignited cautiously in a platinum or quartz crucible until the organic matter is all consumed. Finally, it is heated to constant weight over a Méker burner and weighed as TiO_2 .

The Determination of Titanium Dioxide in Titanium-Iron Ore.

Most titanium ores are very difficultly soluble in the usual solvents. The analysis of these ores is also complicated by the fact that aqueous solutions of titanium salts readily undergo hydrolysis, partly on account of the amphoteric character of titanium dioxide and partly because of the insolubility of this oxide. If sodium titanate, Na_2TiO_3 , is prepared by fusion with sodium carbonate, it undergoes hydrolysis when treated with water and an acid titanate of sodium is precipitated, e.g., $2\text{Na}_2\text{O} \cdot 9\text{TiO}_2 \cdot 5\text{H}_2\text{O}$. This acid titanate is soluble in hydrochloric acid, sp. gr. 1.12, but if the solution is diluted and heated to boiling, hydrolysis takes place, as with any other salt of titanium, and metatitanic acid, H_2TiO_3 , is precipitated. A method for determining titanium after fusing with sodium carbonate and dissolving the sodium titanate in hydrochloric acid has already been given (p. 118).

One of the best methods for attacking titanium dioxide, or an insoluble titanium ore, is based upon the fusion of the ore with potassium acid sulphate. This converts titanium into titanium sulphate,* $(\text{TiSO}_4)_2$, which is soluble in *cold* water. Potassium acid sulphate melts at about 200° and, on further heating, is easily decomposed into potassium pyrosulphate, $\text{K}_2\text{S}_2\text{O}_7$:



which melts at a little over 300° . Upon raising the temperature sufficiently, it is easy to transform the potassium pyrosulphate into normal potassium sulphate, which melts at about 1050° . Between these last two temperatures, sulphuric acid is available for attacking insoluble oxides of iron, aluminium and titanium:

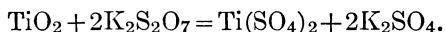

* Titanium sulphate shows a tendency to form complex ions. Thus Warren (Pogg. Ann., **102**, 449 (1857)) obtained the salt $\text{K}_2\text{Ti}(\text{SO}_4)_3$ after fusing with potassium acid sulphate. See also Schutte, Z. anorg. Chem., **26**, 239 (1901).

If the temperature is raised too high, however, TiO_2 may be formed again, as is the case in heating the residue after the removal of silica with hydrofluoric and sulphuric acids:

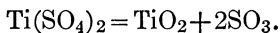

Moreover, if the heating is continued long enough to convert all the pyrosulphate into molten potassium sulphate, there is some danger of the crucible bursting upon the solidification of the melt.*

When potassium acid sulphate^d is decomposed into potassium pyrosulphate and water, the latter is liberated at a temperature far above its boiling-point. There is danger of the contents of the crucible boiling over if the reaction takes place too quickly. Before making the fusion, therefore, it is advisable to heat the potassium sulphate by itself until vapors of sulphuric anhydride begin to be evolved. A low flame of the Bunsen burner is sufficient.

The following procedure is given, not because it gives the most convenient or the most accurate method for determining titanium in an insoluble ore, but because it is an especially good method for teaching the art of fusing with potassium acid sulphate to advanced students in quantitative chemical analysis. The method will give excellent results when properly carried out, but is likely to give too low results if the ore is not entirely decomposed by the acid sulphate fusion, or too high results if the titanous metatitanic acid is not purified sufficiently and washed free from alkali salts.

Procedure.—From 0.4 to 0.6 gm. of the finely-ground ore is weighed into a platinum crucible and fused with 6 to 8 times its weight of sodium carbonate for at least 30 minutes. The fused mass is extracted with hot water and, when the melt is all disintegrated, the solution is decanted through an ashless filter paper. The residue is boiled with 25 c.c. of normal sodium carbonate solution, transferred to the filter, and washed twice with dilute sodium carbonate solution and several times with hot water. This serves to remove the phosphoric acid as sodium

* H. P. Talbot, Quantitative Chemical Analysis, 5th Edition, p. 4.

phosphate,* and to convert titanium into acid sodium titanate; the iron is left with the titanium as insoluble ferric oxide.

The residue and filter paper are ignited in a platinum crucible at a low temperature until the carbon of the filter paper is all consumed. From 12 to 15 parts of potassium pyrosulphate, which has just been prepared by heating potassium acid sulphate until all the water is expelled, are added to the contents of the crucible and the latter is very carefully heated. The temperature should be kept low until all the potassium pyrosulphate has melted, then the heat should be gradually increased until sulphuric acid fumes are noticed on removing the cover of the crucible. At no time should dense fumes be given off from the covered crucible, but it will be necessary to raise the temperature from time to time in order to keep the flux melted. Occasionally the cover of the crucible should be raised to see if the residue has dissolved in the flux. Sometimes the fusion can be accomplished in half an hour, but more often nearly an hour is required. Finally, when the contents of the crucible are at a dull red heat and there is no sign of undissolved material, a coil of platinum wire is suspended in the melt and it is allowed to cool. When cold, the fusion is then withdrawn by heating the sides of the crucible.

The melt is suspended in 200 c.c. of cold water and 100 c.c. of saturated sulphurous acid solution, and allowed to stand in a cool place until solution is complete, stirring from time to time. The solution is usually effected by allowing the dilute acid to stand over night with the melt suspended near the top of the liquid. The process may be hastened by stirring with a mechanical stirrer.

If necessary the solution is filtered, and the residue treated with sulphuric and hydrofluoric acids to expel silica, fused with more potassium pyrosulphate, and the melt added to the solution previously obtained. Finally the solution is diluted to 800 c.c. in a large beaker, 125 c.c. of acetic acid, sp. gr. 1.04,

* Phosphoric acid interferes with the precipitation of metatitanic acid by hydrolysis. It tends to precipitate with the titanium to some extent and also to render the precipitation incomplete.

and 20 gms. of ammonium acetate are added and the solution is boiled five minutes. Just before boiling begins, 25 c.c. more of sulphurous acid solution are added. When the precipitation is complete, the beaker is allowed to stand in a warm place for at least half an hour, and is then filtered through a 9-cm. filter paper. A siphon is meanwhile prepared which is long enough to extend to the bottom of the beaker, with the glass tubing bent upward so that the water will suck into the siphon from above without drawing much precipitate with it. The longer end of the siphon is connected by means of rubber tubing with a short piece of glass tubing which rests just below the upper edge of a 9-cm. washed filter paper. When the precipitated metatitanic acid has settled to the bottom of the beaker, the supernatant solution is siphoned through the filter, regulating the flow by means of a small screw clamp placed on the short piece of rubber tubing, a little way above the funnel.

The precipitate is washed with 5 per cent. acetic acid until most of the sulphate has been removed. The filter and its contents are ignited at as low a temperature as possible and the fusion with potassium pyrosulphate is repeated. This time there should be no difficulty in getting a good fusion. The product of the fusion is treated exactly as before, but the residue is now washed more carefully, until all the sulphate has been removed. The filtered precipitate is ignited and weighed as TiO_2 .

Determination of Sulphur in Pyrite: Fusion with Sodium Peroxide.

The Fresenius method (page 357) has long been accepted as a standard method for determining sulphur in insoluble sulphides, but the procedure is long on account of the necessity of removing all the nitrate before precipitating the sulphuric acid ion. If the analysis is carried out in a platinum crucible the oxidizing mixture attacks the platinum quite badly, which is a serious objection, especially when the analysis is frequently made. If the Fresenius method is carried out in a nickel or iron crucible, it is difficult to raise the temperature sufficiently without using the blast lamp.

It has been repeatedly shown * that equally satisfactory results can be obtained by using sodium peroxide as the oxidizing flux. Moreover, the analysis can be accomplished in about two hours.

Procedure.—About 0.5 gm. of pyrite is mixed with 5 gms. of pure sodium peroxide and 4 gms. of sodium carbonate in a nickel or iron crucible. An opening is cut in a piece of asbestos board (at least four inches square) sufficiently large to allow two-thirds of the crucible to project below the asbestos. The purpose of this shield is to keep the products formed by the combustion of the gas from reaching the mouth of the crucible. Illuminating gas often contains a little sulphur. The fusion mixture is heated gently for ten minutes so that the mass softens and bakes together and then the temperature is raised until the crucible is exposed to the full heat of the Tirrill burner for twenty minutes.

The contents of the crucible are allowed to cool and are treated with 150 c.c. of hot water. When the sodium salts are all dissolved, the crucible is removed and the solution is treated with 5 c.c. of hydrochloric acid, sp. gr. 1.2, to which liquid bromine has been added till the acid is saturated. The purpose of the bromine is to make sure that the oxidation of the sulphur is complete.† It is necessary to add acid as otherwise the hot, caustic soda solution is likely to destroy the filter paper. After heating to boiling, the solution is filtered and the residue of ferric hydroxide is washed free from sulphate.

The filtrate is carefully neutralized with 6-normal hydrochloric acid, sp. gr. 1.12, and 2 c.c. of this acid are added in excess. The solution is heated till all the bromine is expelled, diluted to 250 c.c. and the sulphuric acid precipitated by adding very slowly, while stirring, a slight excess of hot barium chloride solution (20 c.c. of normal barium chloride solution diluted to 100 c.c.).

* W. Hempel, *Z. anorg. Chem.*, **3**, 193 (1893); J. Clark, *J. Chem. Soc.*, **63**, 1079 (1893); Höhnel, *Arch. Pharm.*, **232**, 222 C. Glaser, *Chem.-Ztg.*, **18**, 1448; Fournier, *Revue générale de chimie, pure et appliquée*, 1903, **77**; List, *Z. angew. Chem.*, **1903**, 414.

† A black residue may denote ferrous sulphide or nickelic oxide. It may be tested for sulphur by dissolving in hydrochloric acid and bromine and adding barium chloride to the diluted solution.

The barium sulphate precipitate is washed three times by decantation with hot water, then transferred to the filter and washed free from chloride, dried, ignited and weighed.

If, in the above analysis, the aqueous extract of the sodium peroxide fusion shows manganate or permanganate by the color, these substances may be reduced by the addition of a few drops of alcohol and boiling. Often the reduction of the manganate to manganese dioxide causes a turbidity in the filtrate. This does no harm, as it dissolves without difficulty on making the solution acid.

A Rapid Method for the Determination of Sulphur in Steel.

Principle.—The method depends on the evolution of the sulphur as hydrogen sulphide and its absorption in an ammoniacal cadmium chloride solution, followed by an iodometric titration. As already stated,* it has been shown that in many cases some of the sulphur in iron and steel is not evolved as hydrogen sulphide upon treatment of the sample with hydrochloric acid. This fact has received much attention in the literature and various attempts have been made to overcome the difficulty. Thus T. G. Elliot,† mixes 5 gms. of the iron or steel with 0.25 gm. of anhydrous potassium ferrocyanide, wraps the mixture in filter paper, places it in a covered porcelain crucible, and anneals for twenty minutes in a muffle furnace heated to 750°–850°. The sample is allowed to cool slowly, is broken up in a mortar and then introduced into the evolution flask. The fact that this annealing of the sample serves to convert practically all the sulphur into a form in which it is readily evolved as hydrogen sulphide has been confirmed by other chemists.

It has been shown,‡ however, that if concentrated hydro-

* Cf. page 352.

† Chem. News, **104**, 298 (1911).

‡ Cf. C. Reinhardt, *Stahl u. Eisen*, **10**, 430 (1890); W. Schindler, *Z. angew. Chem.*, **1893**, 11; W. Schulte, *Stahl u. Eisen*, **26**, 935 (1906) and H. Kinder, *ibid.*, **28**, 249 (1908).

chloric acid is used for dissolving the sample, and the sample is dissolved quickly without letting air enter the evolution flask, there is rarely any difficulty in obtaining accurate values by the rapid evolution process which is to be described.

Besides hydrogen and hydrogen sulphide, various other gases are evolved to some extent when a sample of iron or steel is dissolved in hydrochloric acid. To prevent the influence of these gases upon the volumetric determination of the sulphur one of the most satisfactory expedients is to absorb the hydrogen sulphide in an ammoniacal solution of cadmium chloride, to filter off the resulting precipitate of cadmium sulphide, to dissolve it in acid in the presence of iodine, and to titrate the excess of the iodine with sodium thiosulphate solution. The reactions involved are expressed by the following equations:

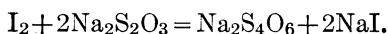
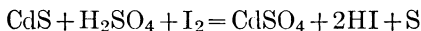
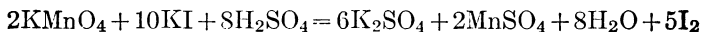
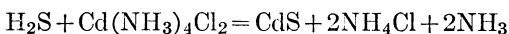
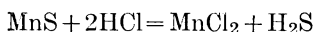
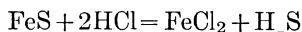

Requisite Solutions.

1. *Sodium Thiosulphate Solution*, approximately 0.02 normal. This is prepared by dissolving 5 gms. of sodium thiosulphate crystals in one liter of freshly boiled water.

2. *Permanganate Solution*, approximately 0.08 normal. It is prepared by dissolving 5 gms. of potassium permanganate in 2 liters of distilled water, allowing the solution to stand some time, and then filtering through asbestos.

3. *Potassium Iodide Solution*.—This is prepared by dissolving 30 gms. of pure potassium iodide and 10 gms. of sodium bicarbonate in a little water, filtering the solution if necessary and diluting to 1 liter.

4. *Soluble Starch Indicator Solution*.—About 0.5 gm. of soluble starch is dissolved in 25 c.c. of boiling water. This

solution is more stable than solutions of ordinary potato starch, and it is much easier to prepare. The solution is ready for use as soon as it is cold. It usually keeps a week or longer.

5. *Ammoniacal Cadmium Chloride Solution*.—20 gms. of cadmium chloride are dissolved in 400 c.c. of water, and 600 c.c. of ammonia, sp. gr. 0.96, are added.

The solution of potassium permanganate is standardized against sodium oxalate (p. 597) using about 0.2 gm. of the salt.

The solution of sodium thiosulphate is standardized by taking 20 c.c. of the potassium iodide solution, adding 25 c.c. of sulphuric acid (1 : 3) and allowing exactly 10 c.c. of the permanganate to run in while stirring. The liberated iodine is then titrated with sodium thiosulphate, adding 2 c.c. of the starch solution toward the last.

Apparatus.—A simple form of apparatus consists of a 250-c.c. round-bottomed flask connected in series with three 150-c.c. Erlenmeyer flasks. Each of the flasks is fitted with two-holed rubber stoppers. The second hole in the stopper of the evolution flask carries a dropping funnel, the end of which reaches nearly to the bottom of the flask. Each delivery tube is bent twice at right angles, starts just below the lower bottom of the rubber stopper in one flask and leads nearly to the bottom of the next.

In the first Erlenmeyer flask is placed 50 c.c. of water to remove most of the hydrochloric acid which is distilled over. It does not absorb an appreciable amount of the hydrogen sulphide gas because it becomes heated nearly to boiling toward the last. The second Erlenmeyer contains 50 c.c. of the cadmium solution and the third 25 c.c. of the same. The hydrogen sulphide is usually absorbed completely in the second flask, but the third flask with its cadmium solution is added as a precaution.

Procedure.—About 5 gms. of the iron or steel is weighed into the evolution flask. The apparatus is connected together and it is made sure that all the joints are tight. 50 c.c. of concentrated hydrochloric acid, sp. gr. 1.19, are placed in the dropping funnel and about half of it is allowed to flow into the flask. If the action is not too vigorous, the remainder of the acid is at once added, but the stop-cock in the dropping funnel is closed

while the tube is still full of acid. This is necessary, because if air enters the solution there is danger of some loss of sulphur owing to oxidation. The evolved hydrogen serves to prevent this oxidation, provided air does not enter through the funnel. The dropping funnel is again filled with 50 c.c. of HCl, and all of this, except enough to fill the stem of the funnel, is added.

As soon as the rate of flow of the gas through the Erlenmeyer flasks becomes less than about 3 bubbles per second, a very low flame is placed below the flask and the flow of gas is maintained steadily at this rate. The burner should be furnished with a flame protector, as otherwise a sudden draft will cause trouble with the small flame. The steel sample should dissolve in about thirty minutes, but it is not advisable to heat too quickly as this will result in too much acid being carried over into the first flask. At first the flame beneath the evolution flask should be only about 0.7 cm. high and it should not be much over 4 cm. high until all the iron has dissolved. When this has taken place, the height of the flame is raised to about 7 cm. and the solution is boiled gently for ten minutes. When the solution begins to boil, the stop-cock in the separatory dropping funnel may be opened. This boiling serves to expel all the hydrogen sulphide from the evolution flask and from the first Erlenmeyer flask. It is unnecessary to pass hydrogen or carbon dioxide through the apparatus, as has been advocated by some chemists. Finally, making sure that the stop-cock in the dropping funnel is open, the flame is removed and the apparatus promptly disconnected.

The precipitated cadmium sulphide is filtered off and washed once or twice with water. The filter and precipitate are placed in a 250-c.c. Erlenmeyer flask containing 20 c.c. of the potassium iodide solution, 25 c.c. of sulphuric acid (1 : 3) and 10 c.c. of the standardized permanganate solution. When all the cadmium sulphide has dissolved, the excess of iodine is titrated with the sodium thiosulphate solution.

Computation.—If 10 c.c. of the permanganate solution = a gm. of pure sodium oxalate, T_1 c.c. of thiosulphate solution were used in titrating 10 c.c. of permanganate, and T_2 c.c. for titrating the same amount of permanganate used in the analysis

of a sample of iron or steel weighing s gms. then the per cent. of sulphur is given by the equation of:

$$a \times \frac{S}{\text{Na}_2\text{C}_2\text{O}_4} \times \frac{(T_1 - T_2) \times 100}{T_1 \times s} = \frac{23.93a(T_1 - T_2)}{T_1 \times s} = \%S.$$

Remark.—Massenez* has recommended the direct titration of the cadmium sulphide precipitate with potassium permanganate. The cadmium solution, without filtering off the precipitate, is boiled thirty minutes to expel hydrocarbons and is then rinsed into a beaker containing 600 c.c. of water and enough permanganate to give a pink tint. Twenty-five c.c. of sulphuric acid (1 : 1) are added and the liberated hydrogen sulphide is titrated with permanganate.

The Determination of Chromium in Steel.

A small quantity of chromium is a common constituent of iron and steel and in some of the alloy steels it is present to the extent of several per cent. The simplest and most rapid method for determining this element consists in oxidizing it to chromate, adding a known quantity of ferrous salt and determining the excess of the latter by titrating with standard potassium permanganate. A great many different methods have been proposed for carrying out the oxidation, two of which are very rapid and give accurate results will be described.

Oxidation by the Barba Method.†

Principle.—The steel is dissolved in dilute sulphuric acid, the iron is oxidized to the ferric state by means of nitric acid, and the chromium is oxidized by the addition of strong permanganate solution. The excess of the latter is destroyed by boiling in ammoniacal solution, the solution is acidified again, the precipitated manganese dioxide filtered off, a known volume of standard ferrous sulphate solution is added to an

* Stahl u. Eisen, 32, 2089 (1912).

† J. Iron and Steel Institute, 1893, ii, 536; The Iron Age, 52, 153.

aliquot part of the filtrate, and the excess of the latter is titrated with permanganate.

Procedure.—Exactly 1.25 gm. of steel is dissolved in 20 c.c. of 6-normal sulphuric acid, sp. gr. 1.2, and when the solution is complete, nitric acid is added drop by drop until the iron is all oxidized to the ferric state, five cubic centimeters of nitric acid, sp. gr. 1.2, is sufficient in most cases. The solution is boiled to remove nitrous fumes, diluted to 150 c.c. and treated with 5 c.c. of a saturated solution of potassium permanganate (6 gms. per 100 c.c.). The solution is boiled briskly for 15 to 20 minutes. It is then removed from the hot plate, the sides of the beaker are washed down with water and 25 c.c. of strong ammonia are poured down the sides of the beaker. The liquid is stirred vigorously and then placed on the cooler part of the hot plate, for if it is heated too rapidly there is likely to be loss by "bumping." The digestion is continued with occasional stirring for fifteen minutes, or until the permanganate is all decomposed as shown by the disappearance of the pink color. Then 20 c.c. of 16-normal sulphuric acid are added cautiously and the solution is heated to boiling. It is transferred to a 250-c.c. calibrated flask, cooled to room temperature, and diluted up to the mark. After thoroughly mixing by pouring back and forth several times into a dry beaker, the solution is filtered and exactly 200 c.c. (corresponding to 1 gm. of metal) is taken for the rest of the analysis. Fifty c.c. of standard ferrous sulphate solution* is added, and the excess titrated with 0.08-normal permanganate.

Computation.—When the ferrous sulphate solution is added, the chromium is reduced from chromic acid to chromic salt in accordance with the following equation:

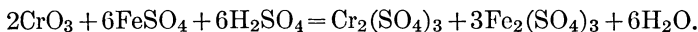

The ferrous sulphate solution is not very stable and should be titrated against the permanganate at the same time the analysis

* Page 617, footnote. This is sufficient in case the steel does not contain more than 2.5 per cent. of chromium. If more chromium than this is present, a smaller aliquot part of the solution should be taken.

is made. If 50 c.c. of the ferrous sulphate solution are equivalent to T_1 c.c. of permanganate, of which 1 c.c. = a gm. of pure sodium oxalate, and T_2 c.c. of permanganate were used in titrating the excess of ferrous sulphate in the analysis of 1 gm. of steel, then

$$\frac{2\text{Cr} \cdot a(T_1 - T_2) \cdot 100}{3\text{Na}_2\text{C}_2\text{O}_4} = 25.86a(T_1 - T_2) = \% \text{ Cr.}$$

Oxidation by Sodium Bismuthate.

1000 c.c. of tenth-normal permanganate = 1.733 gms. Cr.

Principle.—Sodium bismuthate, NaBiO_3 , is often used for oxidizing manganese from the bivalent to septavalent condition (cf. p. 617). This oxidation takes place best in a *cold* solution containing 20 to 40 per cent. of nitric acid (free from nitrous acid) in a volume of 50 to 100 c.c.* Moreover, an excess of sodium bismuthate should be present and the solution must not stand long. Under these conditions scarcely any chromium is oxidized so that the manganese may be determined by the bismuthate method even when chromium is present.† If the solution is heated to boiling, the permanganate is decomposed and the manganese is precipitated as manganese dioxide. Chromium, on the other hand, is oxidized in *hot* solutions from the trivalent to the sexavalent condition and the chromic acid is not decomposed by boiling, unless some reducing agent is present. In hot solutions, therefore, it is possible to oxidize the chromium by sodium bismuthate, to filter off the precipitated manganese dioxide and to determine the chromium in the filtrate by adding

* William Blum, J. Am. Chem. Soc., **34**, 1395.

† This statement has been made by several writers, but considerable evidence has accumulated to prove that, as ordinarily carried out in the laboratory, the bismuthate method for the determination of manganese in a steel containing chromium is likely to give high results due to a partial oxidation of chromium by the bismuthate. If the essential conditions with regard to temperature, acidity and time allowed for the completion of the reaction are adjusted very carefully it is probably possible to get accurate results in the manganese determination but in ordinary practice it is advisable to separate the manganese and chromium by precipitating the latter. This can be accomplished satisfactorily by means of zinc oxide (cf. Volhard method, p. 615). The manganese can then be determined by the bismuthate method in an aliquot part of the filtrate.

a known volume of standard ferrous sulphate solution and titrating the excess of the latter with permanganate.

Procedure.—Two grams of steel are dissolved in a 250-c.c. Erlenmeyer flask in 50 c.c. of nitric acid (sp. gr. 1.13 = 25 per cent. concentrated nitric acid by volume). If there is any carbonaceous residue, as in the analysis of cast irons, it should be filtered off and examined for chromium by fusion with an alkaline oxidizing flux.* If the metal is difficultly soluble in nitric acid, it is sometimes necessary to add sulphuric acid to hasten the solution.

When the sample is all dissolved, the solution is cooled to between 65° and 75° and 2 gms. of sodium bismuthate are added. The contents of the flask are agitated for a few minutes and then the sides of the flask are washed down with a little water. The solution is heated and gently boiled until the permanganate formed from the manganese in the steel is all decomposed as shown by the color. This usually requires about fifteen minutes. Fifty c.c. of nitric acid (3 per cent. by volume) are added and any precipitated manganese dioxide or undissolved sodium bismuthate is filtered off on an asbestos filter. The residue is washed three times with 50 c.c. portions of the dilute nitric acid. The solution is cooled to room temperature by running tap water over the flask and finally diluted with distilled water to 500 c.c. A measured excess of ferrous sulphate solution † is added and the excess titrated with permanganate.

The ferrous sulphate is titrated against the permanganate on the same day that the analysis is made and the same quantities of ferrous sulphate and nitric acid are used as in the analysis. The computation is the same as in the previous analysis. The chemical reactions involved are the following:

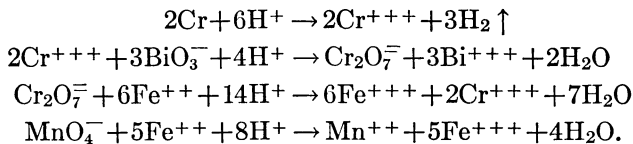

* Cf. p. 675. If the carbonaceous residue is not removed it will interfere with the oxidation of the chromium.

† Cf. p. 617, footnote.

Determination of Tungsten in Ores.

Owing to increased technical use of tungsten, the need of a simple and accurate method for the quantitative estimation of the tungsten content of ores has become apparent and a number of methods have been published. In 1918 Dr. W. F. Hillebrand of the U. S. Bureau of Standards had specimens of ferberite and scheelite ore carefully prepared and analyzed at the Bureau of Standards and by seventeen other laboratories in different parts of the country. The results of the work have not yet been published, but several of the methods have been tested under the direction of the translator and the most satisfactory method is given here in tentative form.

The results of the collaborative work have shown at least three things. First, it is clear that under ordinary working conditions the most satisfactory method for decomposing tungsten minerals is by long digestion with acid. Tungstates, like phosphates, are not always decomposed satisfactorily by fusion with sodium carbonate and, moreover, the introduction of a large quantity of sodium salts is not desirable. Fusion with sodium carbonate and sodium peroxide, as in the Gläser method for analyzing pyrite, in an iron or nickel crucible is much better than fusing with sodium carbonate in platinum. Second, it is extremely difficult to precipitate the last traces of tungsten by repeated evaporation to dryness in acid solution (cf. p. 289). The precipitation may be made complete, however, by adding a little cinchonine hydrochloride. Third, methods depending upon the precipitation of mercurous tungstate are not wholly satisfactory because other mercurous salts are likely to precipitate and cause trouble.

The method to be given is that recommended by J. A. Holliday. It depends upon the decomposition of all tungstates by prolonged treatment with an excess of hydrochloric acid with the eventual addition of nitric acid. During the boiling with acid, tungstic acid anhydride, WO_3 , precipitates and at the last the precipitation is made complete by diluting and adding a little cinchonine hydrochloride.

The precipitated tungstic acid is removed and dissolved in ammonia. It is reprecipitated, in a purer form, by acid and cin-

chonine solution. After gentle ignition, the mixture of tungstic and silicic anhydrides is weighed and the silica removed by treatment with hydrofluoric acid.

Mr. M. C. Hawes, working at the Massachusetts Institute of Technology, obtained excellent results in analyzing both scheelite and ferberite ores.*

Procedure.—Weigh out about 1 gm. of the finely ground ore into a 400 c.c. beaker. Moisten the sample with 5 c.c. of water and add 100 c.c. of concentrated hydrochloric acid. Cover the beaker and digest at about 60° for at least an hour. Stir from time to time to prevent the formation of any crust. Then boil down slowly to about 50 c.c. Add 40 c.c. more of strong hydrochloric acid and 20 c.c. of concentrated nitric acid and evaporate to about 10 c.c. During these operations, especially when fresh acid is added, stir the material at the bottom of the beaker so that it does not become encrusted.

Rinse down the cover-glass and the sides of the beaker and dilute with water to about 150 c.c. If, by accident, the solution was evaporated to dryness during the above treatment, add 20 c.c. of concentrated hydrochloric acid and 10 c.c. of concentrated nitric acid to the residue and evaporate down to 10 or 15 c.c.

To the diluted solution add 5 c.c. of cinchonine hydrochloride solution (prepared by dissolving 12.5 gms. of cinchonine in 100 c.c. of 6-normal hydrochloric acid) and heat on the hot plate for thirty minutes or longer. The solution should be at a temperature just below the boiling-point and should be stirred occasionally.

Allow the tungstic acid anhydride to settle and then decant the solution through a filter which contains some pulp made by digesting ashless filter paper with acid. Wash the precipitate three times with a solution containing 10 c.c. of the above cinchonine solution to a liter of hot water. Then transfer the precipitate to the filter and wash with this same, diluted cinchonine solution.

Wash the tungstic anhydride back into the original beaker by a jet of water, using about 25 c.c. of water to accomplish this. Add 6 c.c. of concentrated ammonia solution and heat gently,

* The method of procedure was obtained from W. F. Hillebrand.

with the beaker covered, for about ten minutes to convert all the tungstic acid into ammonium tungstate. Rinse down the sides of the beaker with hot, dilute ammoniacal ammonium chloride solution (200 c.c. of concentrated ammonia, 800 c.c. of water and 10 c.c. of concentrated hydrochloric acid). Stir up the contents of the beaker and filter through the same filter that was used for the previous filtration. Collect the filtrate in a 400 c.c. beaker and wash the original beaker and filter with the hot ammoniacal solution. The presence of a little ammonium chloride in this ammoniacal solution prevents colloidal silicic acid from passing into the filtrate.

The residue on the filter is usually free from tungsten, but it should be tested by giving it the same treatment as that of the original ore. Ammonium and sodium salts tend to prevent the complete precipitation of tungstic acid, so that it is important, next, to remove the excess ammonia. After this has been evaporated off, add 20 c.c. of concentrated hydrochloric acid and 10 c.c. of concentrated nitric acid and evaporate to about 15 c.c. Dilute with 150 c.c. of water and precipitate the remainder of the tungstic acid by treatment with cinchonine solution as described above.

After filtering and washing the precipitate as before, ignite it carefully in a weighed platinum crucible. The presence of the paper pulp causes the precipitate to form a porous, friable mass and makes it easy to oxidize the carbon. If the ignition is made in a muffle, the introduction of oxygen is advantageous. After burning off the carbon, at as low a temperature as possible, weigh the precipitate and correct for silica by the usual treatment with hydrofluoric acid.

If the tungstic acid is heated over the full flame of the burner, some of it will be lost by volatilization. After the removal of the silica, the residue should be heated to dull redness for only one minute. Heated in the muffle, the maximum temperature should not exceed 800°.

To test the residue insoluble in ammonia for tungsten, ignite it in an iron crucible and fuse the ash with a small quantity of sodium peroxide mixed with a little sodium carbonate. Reducible metals are likely to ruin a platinum crucible if the residue and

filter paper are heated in it. Extract the melt with water and filter. Acidify the aqueous extract with hydrochloric acid, and 5 c.c. of cinchonine and heat for several hours to see if any yellow tungstic acid anhydride is formed.

The ignited tungsten trioxide, WO_3 , should have a clean, lemon-yellow color.

The Determination of Phosphorus in Steel.

J. O. Handy's Method as modified by C. M. Johnson.*

For years chemists have been accustomed to using an acid solution of ammonium molybdate for precipitating phosphoric acid in the analysis of steel. Thus the formula of Blair and Whitfield † calls for 100 gms. MoO_3 , 80 c.c. of concentrated ammonia solution, 400 c.c. of concentrated nitric acid and a liter of water. Such a solution has to be prepared in a particular manner or a part of the molybdic acid will remain undissolved. Moreover, satisfactory results are obtained only when it is freshly prepared. On standing a precipitate forms and the reagent becomes less sensitive. This leads to waste of a relatively expensive reagent.

Molybdic anhydride is not very soluble in water or in dilute nitric acid. If an excess of nitric acid is added to a solution of ammonium molybdate, a supersaturated solution of molybdic acid is obtained. It is probably more or less colloidal in its properties.

All procedures for the precipitation of phosphoric acid with such a reagent have laid emphasis upon getting the phosphoric acid solution nearly neutral before adding the reagent. If a neutral or slightly ammoniacal solution of ammonium molybdate is used as reagent the results are satisfactory if it is added to a solution of phosphoric acid containing nitric acid and ammonium nitrate. The reagent keeps indefinitely, retains its strength and reliability as a reagent, is more sensitive as a precipitant and may be added to solutions having a fairly wide range in acidity.

The Johnson method to be described is a modification of the

* J. I. E. C., 11, 113 (1919).

† J. Am. Chem. Soc., 17, 760 (1895).

Handy method (see p. 588). There is no reason, however, why this method of precipitating phosphoric acid should not be used for other procedures such as the analysis of apatite or the determination of phosphorus in steel by methods depending upon the reduction of the molybdenum (cf. p. 637). In such cases, however, care should be taken to wash the precipitate of ammonium phosphomolybdate with appropriate solutions; the use of nitric acid and potassium nitrate is out of the question if the molybdenum is to be reduced, for nitrous acid is formed by the action of zinc on nitrate ions and reacts with permanganate.

SOLUTIONS REQUIRED.

Standard Sodium Hydroxide and Standard Nitric Acid.—If many analyses are to be made, it is convenient to have these solutions of equal concentration, approximately one-eighth normal. Since 1 c.c. of normal sodium hydroxide is equivalent to 0.001348 gm. of phosphorus, if a sample of steel is taken of which the weight in grams is 13.48 times the normal concentration of the sodium hydroxide (and nitric acid), the per cent. of phosphorus in the steel can be determined by subtracting the volume of nitric acid (in cubic centimeters) from the total volume of sodium hydroxide used and moving the decimal point two places to the left.

Dissolve 21 gms. of pure sodium hydroxide and 0.1 gm. of barium hydroxide in 2 liters of water. Stir the solution well, allow it to stand overnight and filter, or decant off the clear solution in the morning. Dilute the solution with 2 liters more of water and mix thoroughly.

Dilute 83 c.c. of 6-normal nitric acid (sp. gr. 1.2) with distilled water to a volume of 4 liters and shake well.

Titrate the two solutions against one another and dilute the stronger solution until both solutions are equivalent. Standardize the alkali against pure oxalic acid, using phenolphthalein as indicator, or against a steel containing a known amount of phosphorus.

The standardization of the alkali should take place in the cold, exactly as in the analysis of the precipitate. A slight error is introduced by the action of carbonic acid in the air, but in

determining the phosphorus in steel the result is never good to more than three significant figures, so that this error is not serious. The barium hydroxide is added to precipitate any carbonate in the caustic soda. The sodium hydroxide solution should be protected from carbonic acid as much as possible by keeping it in a bottle as described on p. 556.

Ferrous Sulphate Solution.—Dissolve 25 gms. of ferrous sulphate or 40 gms. of ferrous ammonium sulphate in 180 c.c. of concentrated sulphuric acid and 820 c.c. of water.

Concentrated Permanganate.—Dissolve 5 gms. of potassium permanganate in 1 liter of water.

Nitrate Wash.—Use 1 gm. of potassium nitrate per liter.

Acid Wash.—Dilute 32 c.c. of 6-normal nitric acid to 1 liter.

Ammonium Molybdate.—Place 55 gms. of ammonium molybdate and 50 gms. of ammonium nitrate in a 400-c.c. beaker, add 45 c.c. of 6-normal ammonia and 700 c.c. of water. Heat with occasional stirring until nearly all the solid has dissolved. After standing overnight decant off the clear solution through a double filter but do not wash the residue.

Procedure.—Weigh out to the nearest centigram about 1.68 gms. of steel and dissolve in 45 c.c. of 4-normal nitric acid (sp. gr. 1.13) heating over a low flame with the beaker covered. If much carbonaceous residue remains, filter and wash the residue six times with the acid wash.

Add about 3 c.c. of the permanganate and boil three minutes to complete the oxidation of the phosphorus and dissolved carbides. Then add just enough of the ferrous sulphate solution to dissolve the precipitated manganese dioxide (3 c.c. should be sufficient). Boil out the nitrous fumes and add 15 c.c. of 16-normal nitric acid (sp. gr. 1.42). Rinse off the cover-glass and sides of the beaker with a little hot water and add to the hot solution 50 c.c. of ammonium molybdate solution. Stir vigorously for two minutes and allow the precipitate to settle for twenty minutes or a little longer. Filter, wash the precipitate twelve times with small portions of the nitric acid wash and then with the potassium nitrate wash till all acid is removed. This may require forty washings with a high-phosphorus steel. The washing should be done promptly without allowing the precipitate to remain dry

for any length of time. The outside fold of the filter should have no sour taste when the washing is finished.

Place the filter and precipitate in a 150-c.c. beaker and add from a burette enough standard sodium hydroxide solution to cause the yellow color of the precipitate to disappear on macerating the filter to a pulp with a rubber-tipped stirring rod. Dilute the solution to about 3 c.c., add a drop of phenolphthalein and titrate carefully with nitric acid until the pink color disappears.

Analysis of Portland Cement.

The American Society for Testing Materials has adopted a standard set of specifications* for Portland cement, including its physical and chemical testing. The chemical methods recommended were those formulated by a committee, who made a special study of this analysis.† The following directions are based upon the report of the committee but the procedure has been modified slightly in minor details and no attempt made to reproduce the same wording. This scheme of analysis is added partly because of the technical importance of Portland cement and partly because it has proved a satisfactory procedure to place in the hands of students as representative of a complete analysis.

The mode of procedure adopted by the above-mentioned committee called for two evaporations for the removal of the silica. In the discussion of the method, however, it was pointed out that by heating the residue at 120°, not correcting for impurities by the hydrofluoric acid treatment and not correcting the subsequent precipitate formed by ammonia for small traces of silica, results are obtained which are within the permissible analytical error of the correct value.‡ In fact, by this more rapid method, a compensation of errors takes place and the results are better in many cases than if the same operator attempted to carry out the analysis with the utmost precision possible.

The committee also recommended the use of platinum dishes and platinum crucibles as far as possible. The advantages gained

* Proc. Am. Soc. Testing Materials, 12, 301-28 (1912).

† J. Soc. Chem. Ind., 21, 12 (1902); Eng. News, 50, 60 (1903); Eng. Record, 48, 49 (1903).

‡ This statement does not apply to rock analysis.

are obvious, but the price of platinum has become so high that it is the duty of every practical chemist to avoid the use of platinum utensils wherever possible. The errors introduced by using porcelain instead of platinum are insignificant in most cases, although greater care must be taken to allow crucibles to cool before placing them in desiccators, and a longer time should elapse before weighing.

The following directions call for dissolving the ferric and aluminium hydroxides in nitric acid instead of hydrochloric acid. This has the advantage of making it easier to wash the second precipitate of hydroxides and the presence of ammonium nitrate is favorable during the ignition of ferric hydroxide, whereas ammonium chloride reacts to form ferric chloride which is volatile. If the chlorine content is not too high it is also easier to wash the calcium oxalate precipitate; here the presence of a little chloride causes the ignited precipitate to be very hygroscopic.

The original directions call for two precipitations of the calcium and for two precipitations of magnesium. This is unessential in the commercial testing of Portland cement provided the conditions recommended are carefully fulfilled.

Procedure.—Weigh 0.5 gm. of cement into a 250-c.c. porcelain casserole, moisten with 40 c.c. of water and add 20 c.c. of 6-normal hydrochloric acid (sp. gr. 1.1) breaking up with a stirring-rod any lumps that form. Cover the casserole with a watch-glass and digest about fifteen minutes on a hot plate until the cement is decomposed completely. Remove the cover-glass, rinse off the bottom of it with a little water and evaporate to dryness on the water-bath. During the evaporation have the cover-glass raised above the top of the casserole by means of a glass triangle. Heat the casserole and dry residue in a hot closet at 120° for an hour or more.*

* At this temperature, the silica acid becomes dehydrated so that it is practically insoluble in dilute acids. The presence of the calcium chloride from the cement helps the dehydration. The quantity of silica that passes into the next filtrate is negligible and more than balanced by that obtained from the reagents and dishes. The residue should not be baked too hard. At higher temperature combination of basic magnesium salt and silicic acid takes place and alumina is made very insoluble.

Silica.—Moisten the residue with 10 c.c. of 6-normal hydrochloric acid, warm slightly and add 150 c.c. of water. Cover the casserole with a watch-glass and digest ten minutes at a temperature near the boiling-point. Filter into a 300-c.c. beaker, wash twice with 2-normal hydrochloric acid and then with hot water till free from chloride. Transfer the moist precipitate and filter to a weighed porcelain crucible with the paper folded so that the precipitate is entirely covered.* Smoke off the filter paper at a low heat without letting the paper take fire (cf. p. 28). Finally ignite at the full heat of the Méker burner until a constant weight is obtained of a perfectly white precipitate. Report as SiO_2 .

Iron and Alumina.—Add 6-normal ammonium hydroxide (sp. gr. 0.96) to the filtrate until a slight excess is present (about 0.5 c.c.). Boil the solution in a covered beaker until only a faint ammoniacal odor is perceptible, allow the precipitate to settle and filter into a 400-c.c. beaker. Wash once by decantation and once or twice on the filter. Make the filtrate acid and allow it to evaporate on the hot plate, while reprecipitating the iron and alumina.

Wash back the precipitate into the original beaker, place the beaker under the funnel and dissolve the hydroxide remaining on the filter by about 25 c.c. of hot, 2-normal nitric acid. Pour the acid in 5 c.c. portions along the upper edge of the paper and wash once with hot water after each addition of acid. Finally wash the filter free from acid adding 5 c.c. of 2-normal ammonia at the last. Preserve the filter for further use. Heat the nitric acid solution until all of the hydroxide dissolves, dilute to 150 c.c. and precipitate with ammonia as before. Filter through the filter that was used before and wash the precipitate free from chloride. Ignite the precipitate wet in a porcelain crucible and weigh as $\text{Fe}_2\text{O}_3 + \text{Al}_2\text{O}_3$, neglecting the small quantities of TiO_2 , P_2O_5 and Mn_3O_4 which it may possibly contain (see p. 87). Unite the filtrate with that obtained from the first precipitate.

Ferric Oxide.—Transfer the ignited precipitate to a small beaker. Dissolve the traces that remain adhering to the crucible

* The dry silica is very pulverulent and easily lost if the gases from the paper escape too violently, and when the paper takes fire.

by heating small portions of 6-normal hydrochloric acid in it, finally pouring each portion into the beaker. Use 20 c.c. of acid in all. Do not at any time dilute the hydrochloric acid until all the iron in the beaker is dissolved. Heat the acid with the iron and aluminium oxides at about 90° until all the iron has dissolved (cf. p. 109). When a clear solution is obtained, place the beaker on a filter and reduce carefully with stannous chloride (cf. p. 610). Determine the iron contact by the Zimmermann-Reinhardt process (p. 607). Compute the per cent. of Fe_2O_3 present and subtract this from the above weight of the oxides to get the per cent. Al_2O_3 .

Calcium Oxide.—Combine the two filtrates from the ammonium hydroxide precipitation. Make them slightly acid with nitric acid and concentrate to a volume of about 300 c.c. Add 1 gm. of oxalic acid and precipitate the calcium in the hot solution by slowly adding half-normal ammonium hydroxide during five minutes. When the precipitate is distinctly granular, remove from the source of heat and allow the precipitate to settle for thirty minutes or an hour. Ignite the moist precipitate and weigh as oxide (cf. p. 70), as sulphate (p. 71), or as carbonate (p. 72). The oxalate can be converted to sulphate or carbonate in a porcelain crucible but it is necessary to heat over a good burner in a *covered* platinum crucible in order to get complete conversion to the oxide. A Meker burner is desirable for this purpose.

Instead of determining the calcium gravimetrically, it is equally accurate to determine the oxalate in the precipitate by permanganate titration (p. 623). Report as CaO.

Magnesium Oxide.—Acidify the filtrate from the calcium precipitation and concentrate to about 400 c.c. Precipitate the magnesium by the Schmitz method (p. 67) and weigh as pyrophosphate after careful ignition in a porcelain crucible. Report the per cent. MgO.

Alkalies.—If it is desired to determine the alkalies the J. L. Smith method should be used (p. 496).

Loss on Ignition.—Heat 0.5 gm. of the cement for five minutes in a platinum crucible over a low flame, then heat strongly for fifteen minutes.

Sulphuric Anhydride.—Fuse, in an iron crucible, 0.5 gm. of

cement with 2 gms. of sodium peroxide and an equal weight of sodium carbonate, protecting the contents of the crucible from the flame as directed on p. 848. After the fusion, extract the soluble salts by treatment with hot water. Filter, make acid with hydrochloric acid and evaporate to dryness on the steam table. Moisten the residue with 5 c.c. of 6-normal hydrochloric acid, dilute with 200 c.c. of water and filter. Wash thoroughly and precipitate the sulphate in 400 c.c. of boiling solution by the addition of barium chloride (p. 469). Filter, ignite and weigh. Report as per cent. SO_3 .

APPENDIX II.

SPECIFIC GRAVITY OF STRONG ACIDS AT $\frac{15^\circ}{4^\circ}$ IN VACUO.

(According to LUNGE, ISLER, NAEF, and MARCHLEWSKY.)*

Specific Gravity $\frac{15^\circ}{4^\circ}$ at $\frac{4^\circ}{\text{Vacuo.}}$	Per Cent. by Weight.			Specific Gravity $\frac{15^\circ}{4^\circ}$ at $\frac{4^\circ}{\text{Vacuo.}}$	Per Cent. by Weight.	
	HCl.	HNO ₃	H ₂ SO ₄ .		HNO ₃ .	H ₂ SO ₄ .
1.000	0.16	0.10	0.09	1.235	37.51	31.70
1.005	1.15	1.00	0.95	1.240	38.27	32.28
1.010	2.14	1.90	1.57	1.245	39.03	32.86
1.015	3.12	2.80	2.30	1.250	39.80	33.43
1.020	4.13	3.70	3.03	1.255	40.56	34.00
1.025	5.15	4.60	3.76	1.260	41.32	34.57
1.030	6.15	5.50	4.49	1.265	42.08	35.14
1.035	7.15	6.38	5.23	1.270	42.85	35.71
1.040	8.16	7.26	5.96	1.275	43.62	36.29
1.045	9.16	8.13	6.67	1.280	44.39	36.87
1.050	10.17	8.99	7.37	1.285	45.16	37.45
1.055	11.18	9.84	8.07	1.290	45.93	38.03
1.060	12.19	10.67	8.77	1.295	46.70	38.61
1.065	13.19	11.50	9.47	1.300	47.47	39.19
1.070	14.17	12.32	10.19	1.305	48.24	39.77
1.075	15.16	13.14	10.90	1.310	49.05	40.35
1.080	16.15	13.94	11.60	1.315	49.88	40.93
1.085	17.13	14.73	12.30	1.320	50.69	41.50
1.090	18.11	15.52	12.99	1.325	51.51	42.08
1.095	19.06	16.31	13.67	1.330	52.34	42.66
1.100	20.01	17.10	14.35	1.335	53.17	43.20
1.105	20.97	17.88	15.03	1.340	54.04	43.74
1.110	21.92	18.66	15.71	1.345	54.90	44.28
1.115	22.86	19.44	16.36	1.350	55.76	44.82
1.120	23.82	20.22	17.01	1.355	56.63	45.35
1.125	24.78	20.99	17.66	1.360	57.54	45.88
1.130	25.75	21.76	18.31	1.365	58.45	46.41
1.135	26.70	22.53	18.96	1.370	59.36	46.94
1.140	27.66	23.30	19.61	1.375	60.27	47.47
1.145	28.61	24.07	20.26	1.380	61.24	48.00
1.150	29.57	24.83	20.91	1.385	62.21	48.53
1.155	30.55	25.59	21.55	1.390	63.20	49.06
1.160	31.52	26.35	22.19	1.395	64.22	49.59
1.165	32.49	27.11	22.83	1.400	65.27	50.11
1.170	33.46	27.87	23.47	1.405	66.37	50.63
1.175	34.42	28.62	24.12	1.410	67.47	51.15
1.180	35.39	29.37	24.76	1.415	68.60	51.66
1.185	36.31	30.12	25.40	1.420	69.77	52.15
1.190	37.23	30.87	26.04	1.425	70.95	52.63
1.195	38.16	31.60	26.68	1.430	72.14	53.11
1.200	39.11	32.34	27.32	1.435	73.35	53.59
1.205		33.07	27.95	1.440	74.64	54.07
1.210		33.80	28.58	1.445	75.94	54.55
1.215		34.53	29.21	1.450	77.24	55.03
1.220		35.26	29.84	1.455	78.56	55.50
1.225		36.01	30.48	1.460	79.94	55.97
1.230		36.76	31.11	1.465	81.38	56.43

* Lunge-Berl. Chem. techn. Untersuchungsmethoden, 6th ed., Vol. I, Tables, 61, 39, 49.

SPECIFIC GRAVITY OF STRONG ACIDS AT $\frac{15^\circ}{4^\circ}$ IN VACUO.—*Cont.*

(According to ISLER, NAEF, and MARCHLEWSKY.)

Specific Gravity $\frac{15^\circ}{4^\circ}$ (Vacuo).	Per Cent. by Weight.		Specific Gravity $\frac{15^\circ}{4^\circ}$ (Vacuo).	Per Cent. by Weight. H ₂ SO ₄ .	Specific Gravity $\frac{15^\circ}{4^\circ}$ (Vacuo).	Per Cent. by Weight. H ₂ SO ₄ .
	HNO ₃ .	H ₂ SO ₄ .				
1.470	82.86	56.90	1.610	69.56	1.750	81.56
1.475	84.41	57.37	1.615	70.00	1.755	82.00
1.480	86.01	57.83	1.620	70.42	1.760	82.44
1.485	87.66	58.28	1.625	70.85	1.765	83.01
1.490	89.86	58.74	1.630	71.27	1.770	83.51
1.495	91.56	59.22	1.635	71.70	1.775	84.02
1.500	94.04	59.70	1.640	72.12	1.780	84.50
1.505	96.34	60.18	1.645	72.55	1.785	85.10
1.510	98.05	60.65	1.650	72.96	1.790	85.70
1.515	99.02	61.12	1.655	73.40	1.795	86.30
1.520	99.62	61.59	1.660	73.81	1.800	86.92
1.525		62.06	1.665	74.24	1.805	87.60
1.530		62.53	1.670	74.66	1.810	88.30
1.535		63.00	1.675	75.08	1.815	89.16
1.540		63.43	1.680	75.50	1.820	90.05
1.545		63.85	1.685	75.94	1.825	91.00
1.550		64.26	1.690	76.38	1.830	92.10
1.555		64.67	1.695	76.76	1.835	93.56
1.560		65.20	1.700	77.17	1.840	95.60
1.565		65.65	1.705	77.60	1.8405	95.95
1.570		66.09	1.710	78.04	1.8410	96.38
1.575		66.53	1.715	78.48	1.8415	97.35
1.580		66.95	1.720	78.92	1.8410	98.20
1.585		67.40	1.725	79.36	1.8405	98.52
1.590		67.83	1.730	79.80	1.8400	98.72
1.595		68.26	1.735	80.24	1.8395	98.77
1.600		68.70	1.740	80.68	1.8390	99.12
1.605		69.13	1.745	81.12	1.8385	99.31

SPECIFIC GRAVITY OF POTASSIUM AND SODIUM HYDROXIDE SOLUTIONS AT 15° C.

Specific Gravi.y.	Per Cent. KOH.	Per Cent. NaOH.	Specific Gravi.y.	Per Cent. KOH.	Per Cent. NaOH.
1.007	0.9	0.59	1.252	27.0	22.50
1.014	1.7	1.20	1.263	28.2	23.50
1.022	2.6	1.65	1.274	28.9	24.48
1.029	3.5	2.50	1.285	29.8	25.50
1.037	4.5	3.22	1.297	30.7	26.58
1.045	5.6	3.79	1.308	31.8	27.65
1.052	6.4	4.50	1.320	32.7	28.83
1.060	7.4	5.20	1.332	33.7	30.00
1.067	8.2	5.86	1.345	34.9	31.20
1.075	9.2	6.58	1.357	35.9	32.50
1.083	10.1	7.30	1.370	36.9	33.73
1.091	10.9	8.07	1.383	37.8	35.00
1.100	12.0	8.78	1.397	38.9	36.36
1.108	12.9	9.50	1.410	39.9	37.65
1.116	13.8	10.30	1.424	40.9	39.06
1.125	14.8	11.06	1.438	42.1	40.47
1.134	15.7	11.90	1.453	43.4	42.02
1.142	16.5	12.69	1.468	44.6	43.58
1.152	17.6	13.50	1.483	45.8	45.16
1.162	18.6	14.35	1.498	47.1	47.73
1.171	19.5	15.15	1.514	48.3	48.41
1.180	20.5	16.00	1.530	49.4	50.10
1.190	21.4	16.91	1.546	50.6	—
1.200	22.4	17.81	1.563	51.9	—
1.210	23.3	18.71	1.580	53.2	—
1.220	24.2	19.65	1.597	54.5	—
1.231	25.1	20.69	1.615	55.9	—
1.241	26.1	21.55	1.634	57.5	—

SPECIFIC GRAVITY OF AMMONIA SOLUTIONS AT 15° C.

(According to LUNGE and WIERNIK.)*

Specific Gravity.	Per Cent. NH ₃ .	Specific Gravity.	Per Cent. NH ₃ .
1.000	0.00	0.940	15.63
0.998	0.45	0.938	16.22
0.996	0.91	0.936	16.82
0.994	1.37	0.934	17.42
0.992	1.84	0.932	18.03
0.990	2.31	0.930	18.64
0.988	2.80	0.928	19.25
0.986	3.30	0.926	19.87
0.984	3.80	0.924	20.49
0.982	4.30	0.922	21.12
0.980	4.80	0.920	21.75
0.978	5.30	0.918	22.39
0.976	5.80	0.916	23.03
0.974	6.30	0.914	23.68
0.972	6.80	0.912	24.33
0.970	7.31	0.910	24.99
0.968	7.82	0.908	25.65
0.966	8.33	0.906	26.31
0.964	8.84	0.904	26.98
0.962	9.35	0.902	27.65
0.960	9.91	0.900	28.33
0.958	10.47	0.898	29.01
0.956	11.03	0.896	29.69
0.954	11.60	0.894	30.37
0.952	12.17	0.892	31.05
0.950	12.74	0.890	31.75
0.948	13.31	0.888	32.50
0.946	13.88	0.886	33.25
0.944	14.46	0.884	34.10
0.942	15.04	0.882	34.95

* Lunge-Berl, Chem. techn. Untersuchungsmethoden, 6th edition, p. 531.

TENSION OF WATER VAPOR ACCORDING TO REGNAULT.

Degrees, C.	Tension in Millimeters.	Degrees, C.	Tension in Millimeters.	Degrees, C.	Tension in Millimeters.
-2.0	3.955	+2.0	5.302	+6.0	6.998
1.9	3.985	2.1	5.340	6.1	7.047
1.8	4.016	2.2	5.378	6.2	7.095
1.7	4.047	2.3	5.416	6.3	7.144
1.6	4.078	2.4	5.454	6.4	7.193
1.5	4.109	2.5	5.491	6.5	7.242
1.4	4.140	2.6	5.530	6.6	7.292
1.3	4.171	2.7	5.569	6.7	7.342
1.2	4.203	2.8	5.608	6.8	7.392
1.1	4.235	2.9	5.647	6.9	7.442
1.0	4.267	3.0	5.687	7.0	7.492
0.9	4.299	3.1	5.727	7.1	7.544
0.8	4.331	3.2	5.767	7.2	7.595
0.7	4.364	3.3	5.807	7.3	7.647
0.6	4.397	3.4	5.848	7.4	7.699
0.5	4.430	3.5	5.889	7.5	7.751
0.4	4.463	3.6	5.930	7.6	7.804
0.3	4.497	3.7	5.972	7.7	7.857
0.2	4.531	3.8	6.014	7.8	7.910
0.1	4.565	3.9	6.055	7.9	7.964
0.0	4.600	4.0	6.097	8.0	8.017
+0.1	4.633	4.1	6.140	8.1	8.072
0.2	4.667	4.2	6.183	8.2	8.126
0.3	4.700	4.3	6.226	8.3	8.181
0.4	4.733	4.4	6.270	8.4	8.236
0.5	4.767	4.5	6.313	8.5	8.291
0.6	4.801	4.6	6.357	8.6	8.347
0.7	4.836	4.7	6.401	8.7	8.404
0.8	4.871	4.8	6.445	8.8	8.461
0.9	4.905	4.9	6.490	8.9	8.517
1.0	4.940	5.0	6.534	9.0	8.574
1.1	4.975	5.1	6.580	9.1	8.632
1.2	5.011	5.2	6.625	9.2	8.690
1.3	5.047	5.3	6.671	9.3	8.748
1.4	5.082	5.4	6.717	9.4	8.807
1.5	5.118	5.5	6.763	9.5	8.865
1.6	5.155	5.6	6.810	9.6	8.925
1.7	5.191	5.7	6.857	9.7	8.985
1.8	5.228	5.8	6.904	9.8	9.045
1.9	5.265	5.9	6.951	9.9	9.105

TENSION OF WATER VAPOR.—*Continued.*

Degrees, C.	Tension in Millimeters.	Degrees, C.	Tension in Millimeters.	Degrees C.	Tension in Millimeters
+10.0	9.165	+14.0	11.903	+18.0	15.357
10.1	9.227	14.1	11.936	18.1	15.451
10.2	9.238	14.2	12.064	18.2	15.552
10.3	9.350	14.3	12.142	18.3	15.650
10.4	9.412	14.4	12.220	18.4	15.747
10.5	9.474	14.5	12.298	18.5	15.845
10.6	9.537	14.6	12.378	18.6	15.945
10.7	9.601	14.7	12.458	18.7	16.045
10.8	9.665	14.8	12.538	18.8	16.145
10.9	9.728	14.9	12.619	18.9	16.246
11.0	9.792	15.0	12.699	19.0	16.346
11.1	9.857	15.1	12.781	19.1	16.449
11.2	9.923	15.2	12.864	19.2	16.552
11.3	9.989	15.3	12.947	19.3	16.655
11.4	10.054	15.4	13.029	19.4	16.758
11.5	10.120	15.5	13.112	19.5	16.861
11.6	10.187	15.6	13.197	19.6	16.967
11.7	10.255	15.7	13.281	19.7	17.073
11.8	10.322	15.8	13.366	19.8	17.179
11.9	10.389	15.9	13.451	19.9	17.285
12.0	10.457	16.0	13.536	20.0	17.391
12.1	10.526	16.1	13.623	20.1	17.500
12.2	10.596	16.2	13.710	20.2	17.608
12.3	10.665	16.3	13.797	20.3	17.717
12.4	10.734	16.4	13.885	20.4	17.826
12.5	10.804	16.5	13.972	20.5	17.935
12.6	10.875	16.6	14.062	20.6	18.047
12.7	10.947	16.7	14.151	20.7	18.159
12.8	11.019	16.8	14.241	20.8	18.271
12.9	11.090	16.9	14.331	20.9	18.383
13.0	11.162	17.0	14.421	21.0	18.495
13.1	11.235	17.1	14.513	21.1	18.610
13.2	11.309	17.2	14.605	21.2	18.724
13.3	11.383	17.3	14.697	21.3	18.839
13.4	11.456	17.4	14.790	21.4	18.954
13.5	11.530	17.5	14.882	21.5	19.069
13.6	11.605	17.6	14.977	21.6	19.187
13.7	11.681	17.7	15.072	21.7	19.305
13.8	11.757	17.8	15.167	21.8	19.423
13.9	11.832	17.9	15.262	21.9	19.541

TENSION OF WATER VAPOR.—Continued.

Degrees, C.	Tension in Millimeters.	Degrees, C.	Tension in Millimeters.	Degrees, C.	Tension in Millimeters.
+22.0	19.659	+26.0	24.988	+30.0	31.543
22.1	19.780	26.1	25.138	30.1	31.729
22.2	19.901	26.2	25.288	30.2	31.911
22.3	20.022	26.3	25.438	30.3	32.094
22.4	20.143	26.4	25.588	30.4	32.278
22.5	20.265	26.5	25.738	30.5	32.463
22.6	20.389	26.6	25.891	30.6	32.650
22.7	20.514	26.7	26.045	30.7	32.837
22.8	20.639	26.8	26.198	30.8	33.026
22.9	20.763	26.9	26.351	30.9	33.215
23.0	20.888	27.0	26.505	31.0	33.405
23.1	21.016	27.1	26.663	31.1	33.596
23.2	21.144	27.2	26.820	31.2	33.787
23.3	21.272	27.3	26.978	31.3	33.970
23.4	21.400	27.4	27.136	31.4	34.174
23.5	21.528	27.5	27.294	31.5	34.368
23.6	21.659	27.6	27.455	31.6	34.564
23.7	21.790	27.7	27.617	31.7	34.761
23.8	21.921	27.8	27.778	31.8	34.959
23.9	22.053	27.9	27.939	31.9	35.159
24.0	22.184	28.0	28.101	32.0	35.359
24.1	22.319	28.1	28.267	32.1	35.559
24.2	22.453	28.2	28.433	32.2	35.760
24.3	22.588	28.3	28.599	32.3	35.962
24.4	22.723	28.4	28.765	32.4	36.165
24.5	22.858	28.5	28.931	32.5	36.370
24.6	22.996	28.6	29.101	32.6	36.576
24.7	23.135	28.7	29.271	32.7	36.783
24.8	23.273	28.8	29.441	32.8	36.991
24.9	23.411	28.9	29.612	32.9	37.200
25.0	23.550	29.0	29.782	33.0	37.410
25.1	23.692	29.1	29.956	33.1	37.621
25.2	23.834	29.2	30.131	33.2	37.832
25.3	23.976	29.3	30.305	33.3	38.045
25.4	24.119	29.4	30.479	33.4	38.258
25.5	24.261	29.5	30.654	33.5	38.473
25.6	24.406	29.6	30.833	33.6	38.689
25.7	24.552	29.7	31.011	33.7	38.906
25.8	24.697	29.8	31.190	33.8	39.124
25.9	24.842	29.9	31.369	33.9	39.344

TENSION OF WATER VAPOR.—Continued.

Degrees, C.	Tension, Millimeters.	Degrees, C.	Tension, Millimeters.	Degrees, C.	Tension, Millimeters.
+34.0	39.565	+34.4	40.455	+34.8	41.364
34.1	39.786	34.5	40.680	34.9	41.595
34.2	40.007	34.6	40.907		
34.3	40.230	34.7	41.135	35.0	41.827

HEATS OF COMBUSTION OF 1 LITER OF GAS MEASURED AT 0°
AND 760 MM. BAROMETRIC PRESSURE.

Gas.	Weight of One Liter.	Referred to	
		Gaseous Water Calories.	Liquid Water Calories.
Carbon monoxide.....	1.25016	2,560	3,034
Hydrogen.....	0.09004	2,595	3,077
Methane.....	0.71488	8,505	9,469
Ethylene.....	1.25899	14,018	14,989
Propylene.....	1.93660	21,226	22,720
Benzene-gas.....	3.48428	(?) 33,750	(?) 35,198
Acetylene.....	1.18080	13,582	14,073
Generator-gas.....	—	about 900	about 1,000
Water-gas.....	—	“ 3,386	“ 3,700
Dowson gas.....	—	“ 1,400	—
Illuminating-gas.....	—	“ 5,000	“ 5,500

The values in the above table are based upon Thomsen's measurements and only in the case of benzene is the theoretical density used.*

* Julius Thomsen, Thermochem. Untersuchungen (1882), Vol. II, pp. 56, 85, 107, and Vol. IV, p. 254.

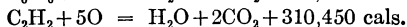
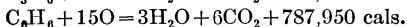
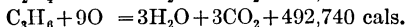
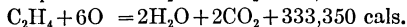
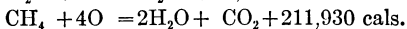
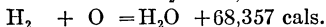
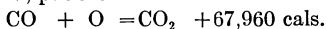

TABLES FOR CALCULATING ANALYSES.

DIRECTIONS FOR USING THE TABLES.

Computations of Gravimetric Analysis.—The methods of computing the results in gravimetric work were outlined on pp. 1 to 6. In the so-called *direct analysis* it is assumed that all of the desired element in the original substance is converted into a weighed precipitate of which a known fraction consists of the element in question. The fraction, usually expressed as a decimal, which represents the amount of an element *A* in one of its compounds is commonly called the *chemical factor*: It represents the weight of *A* in one part by weight of the compound, independent of what unit of weight is used.

Thus, to be specific, 1 gm. of silver chloride contains 0.7526 gm. of silver; 1 lb. of silver chloride contains 0.7526 lb. of silver. If *p* gm. of silver chloride are obtained from *s* gm. of original substance, then $0.7526p$ is the weight of silver in the sample taken and $\frac{0.7526p \times 100}{s}$ = per cent. of silver in the substance analyzed.

The general rule for computing a direct gravimetric analysis is as follows: Multiply the weight of precipitate by 100 times the chemical factor and divide by the weight of the original substance. Using the notation as above:

$$\frac{p \times \text{chem. factor} \times 100}{s} = \text{desired percentage.}$$

A table of chemical factors is given on the following pages. The use of the table may be illustrated by an example:

From 0.5 gm. of arsenic ore, 0.4761 gm. of $\text{Mg}_2\text{As}_2\text{O}_7$ was obtained. What is the per cent. of arsenic in the ore?

In the table (p. 884) we seek As under the heading "Sought" and $\text{Mg}_2\text{As}_2\text{O}_7$ under the heading "Found," and we find on the same line that the chemical factor is 0.48269. Finally, in the

fourth column we find that the logarithm of this number multiplied by 100 is 1.6837. The computation is as follows:

log factor $\times 100$	1.6837
log 0.4761	9.6777 - 10
colog 0.5	0.3010
	1.6624 log of 45.96

The ore contains 45.96 per cent. of arsenic.

If the weight of ore had been 0.4827 gm. (a so-called *factor weight*) the per cent. of arsenic would have been found by multiplying the weight of precipitate by 100.

This table of factors is convenient, but every chemist should know how to compute any factor. As this often causes trouble for beginners, the method of computing the factors will be discussed.

Computing the Factor.—The symbol AgCl shows that one atomic weight of silver, 107.88, is present in 1 molecular weight of silver chloride, 143.34. This ratio of weights is independent of the unit of weight used and is just as true of tons, pounds, ounces or grains as it is of grams. Using the conception of the gram-molecular weight, the formula shows that 107.88 gms. of silver are present in 143.34 gms. of silver chloride. If 143.34 gms. of silver chloride contain 107.88 gms. of silver, 1 gm. of silver chloride will contain $\frac{107.88}{143.34} = 0.7526$ gm. silver. In other words, the chemical factor for silver in silver chloride is found by dividing the atomic weight of silver by the molecular weight of silver chloride. Using symbols, the chemical factor in this case is $\frac{\text{Ag}}{\text{AgCl}}$. It represents the ratio of *what is sought to what has been found*.

In the case of the arsenic analysis referred to above, the symbol for magnesium pyroarsenate, $\text{Mg}_2\text{As}_2\text{O}_7$, shows that 2 atoms of arsenic are present in the molecule. The chemical factor is $\frac{2\text{As}}{\text{Ag}_2\text{As}_2\text{O}_7} = \frac{149.9}{477.9} = 0.4827$.

As a still more complicated case, assume that a sample of magnetite is analyzed in such way that all of the iron is converted

into Fe_2O_3 and it is desired to know the weight of Fe_3O_4 originally present. The chemical factor for converting a weight of Fe_2O_3 into the equivalent weight of Fe_3O_4 is $\frac{2\text{Fe}_3\text{O}_4}{3\text{Fe}_2\text{O}_3} = \frac{463.1}{479.1} = 1.035$.

The concept of the *chemical factor* may be applied to any chemical equation as well as to any precipitate. The following equation represents the reaction between ferrous ions and dichromate ions:

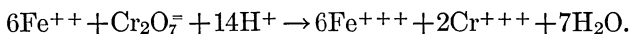

On the basis of this equation we can compute the weight of ferrous ammonium sulphate, which will react with a given weight of potassium dichromate. The chemical factor is

$$\frac{6[\text{FeSO}_4 \cdot (\text{NH}_4)_2\text{SO}_4 \cdot 6\text{H}_2\text{O}]}{\text{K}_2\text{Cr}_2\text{O}_7} = \frac{6 \times 392}{294} = 8.$$

If the weight of dichromate is multiplied by this factor the product will be the equivalent of ferrous ammonium sulphate. If a weight of ferrous ammonium sulphate is divided by 8, the quotient is the equivalent weight of dichromate.

It is possible to arrive at the same result by a slightly different method of reasoning and this other method is more like the method used in volumetric computations. If the weight of ferrous ammonium sulphate, p , is divided by the molecular weight of ferrous ammonium sulphate, the quotient represents the number of moles of ferrous ammonium sulphate present. The equation, however, shows that one-sixth as many moles of dichromate are required so that by dividing by six and multiplying by the molecular weight of dichromate the weight of dichromate is obtained. In each case the computation may be expressed as follows:

$$\frac{p \times \text{K}_2\text{Cr}_2\text{O}_7}{\text{FeSO}_4 \cdot (\text{NH}_4)_2\text{SO}_4 \cdot 6\text{H}_2\text{O} \times 6} = \text{weight of dichromate.}$$

The fraction $\frac{\text{K}_2\text{Cr}_2\text{O}_7}{6\text{FeSO}_4 \cdot (\text{NH}_4)_2\text{SO}_4 \cdot 6\text{H}_2\text{O}}$ represents the weight of dichromate which corresponds to 1 gm. of ferrous ammonium sulphate, the fraction $\frac{p}{\text{FeSO}_4 \cdot (\text{NH}_4)_2\text{SO}_4 \cdot 6\text{H}_2\text{O}}$ represents the number of moles of ferrous ammonium sulphate present.

It is evident from the foregoing discussion that ordinary chemical arithmetic is really very simple. Formerly the so-called "rule of three" was used more in elementary texts on arithmetic than it is to-day. In Germany it is still used a great deal more than in the United States. Most text books on analytical chemistry have been influenced by German practice and beginners in chemistry have been taught to use proportions in chemical arithmetic instead of reasoning out unit values as they have been taught before studying chemistry. In the above discussion not a single proportion has been written out to be solved mechanically by the rule that "the product of the means is equal to the product of the extremes."

Computations of Volumetric Analysis.

1. *Relative Strength of Solutions.*

(a) If a c.c. of solution $A = b$ c.c. of solution B , then 1 c.c. of solution $A = \frac{b}{a}$ c.c. solution B ; 1 c.c. of $B = \frac{a}{b}$ c.c. of A .

(b) If solution A is N -normal, then solution B is $\frac{a}{b} \times N$ -normal.

(c) If solution A is N -normal and solution B is M -normal, then 1 c.c. of $A = N/M$ c.c. of B ; 1 c.c. of $B = M/N$ c.c. of A .

2. *Normal Strength or Normality.*

(a) To find the normality, divide the value of 1 c.c. in terms of any pure substance by the milli-equivalent of that substance.

(b) If N be the normality, and e the milli-equivalent, then 1 c.c. of the solution $= e \times N$ gm. of the substance in question.

The milli-equivalent is often less than a milli-mole: thus 1 c.c. of 0.3 Normal acid $= 0.3 \times 0.031$ gm. of Na_2O .

3. *General Method of Finding the Per Cent. by Weight.*

Let c.c. represent the net volume of reagent required, N the normality of the reagent, s the weight of substance taken, and e the milli-equivalent of the constituent whose percentage is required. Then

$$\frac{\text{c.c.} \times N \times e \times 100}{s} = \text{per cent.}$$

Note that if $s = N \cdot e \cdot 100$, then c.c. = per cent.

4. *Equivalent Weights.*

(a) Acids. Let M = molecular weight, MO = methyl orange, P = phenolphthalein. The first three acids may be titrated with either indicator.

<i>Acid.</i>	<i>Equivalent.</i>
HCl	M
HNO ₃	M
H ₂ SO ₄	M/2
HC ₂ H ₃ O ₂	M (With P)
H ₂ C ₄ H ₄ O ₆	M/2 (With P)
H ₂ CO ₃	M (With P)
KHC ₄ H ₄ O ₆	M (With P)
H ₂ C ₂ O ₄ · 2H ₂ O	M/2 (With P)
KHC ₂ O ₄	M (With P)
KHC ₂ O ₄ · H ₂ C ₂ O ₄ · 2H ₂ O	M/3 (With P)
H ₃ PO ₄	M (With MO)
H ₃ PO ₄	M/2 (With P)
H ₃ BO ₃	M (With P and glycerine, not acid to MO)

<i>(b) Bases.</i>	<i>Equivalent.</i>
KOH	M
NaOH	M
NH ₄ OH (With MO)	M
Ba(OH) ₂	M/2

(c) SALTS OF WEAK ACIDS.

Salts of carbonic and boric acids may be titrated with methyl orange as if the free base were present. With phenolphthalein the end-point is reached when the carbonate is completely changed to bicarbonate. Thus BaCO₃ titrates as if it were Ba(OH)₂ with methyl orange but reacts with only one (1) equivalent of acid if phenolphthalein be used in the cold.

(d) OXIDIZING AGENTS:

<i>Substance.</i>	<i>Reduction Change.</i>	<i>Equivalent.</i>
K ₂ Cr ₂ O ₇	Each Cr loses 3 charges	M/6
K ₂ InO ₄	Mn ^{+VII} to Mn ^{+II}	M/5
KMnO ₄	Mn ^{+VII} to MnO ₂	M/3
MnO ₂	Mn ^{+IV} to Mn ^{+II}	M/2
KBrO ₃ or KIO ₃	(Br or I) ^{+V} to (Br or I) ^{-I}	M/6
Free Cl, Br, I	To (Cl, Br, or I) ^{-I}	At. Wt.
Cu ⁺⁺ (Iodide method)	To Cu ⁺	At. Wt.
Na ₂ O ₂	O [±] to O ⁼	M/2

(e) REDUCING AGENTS:

<i>Substance.</i>	<i>Reduction Change.</i>	<i>Equivalent.</i>
H ₂ S	S ⁼ to S ⁰	M/2
SnCl ₂	Sn ⁺⁺ to Sn ⁺⁺⁺⁺	M/2
HI	I ⁻ to I ⁰	M
Zn	Zn ⁰ to Zn ⁺⁺	M/2
Fe	Fe ⁰ to Fe ⁺⁺	M/2
Fe (After solution in acid)	Fe ⁺⁺ to Fe ⁺⁺⁺	At. Wt.
Fe (Any ferrous salt containing 1 Fe)	Fe ⁺⁺ to Fe ⁺⁺⁺	M
H ₂ O ₂ (With KMnO ₄)	O [±] to O ⁺⁺	M/2
K ₄ Fe(CN) ₆	To [Fe(CN) ₆] ⁼	M
H ₂ C ₂ O ₄ ·H ₂ O or KHC ₂ O ₄ or Na ₂ C ₂ O ₄	To 2 CO ₂	M/2
KHC ₂ O ₄ ·H ₂ C ₂ O ₄ ·H ₂ O ₂	To 4 CO ₂	M/4
Na ₂ S ₂ O ₃	To $\frac{1}{2}$ Na ₂ S ₄ O ₆	M
As ₂ O ₃	To 2AsO ₃ ⁼ or 2AsO ₃ ⁻	M/4

5. *Equivalent weight depends on the reaction.*

Considered as a salt (that is, as if it were a precipitant) the equivalent weight of KMnO₄ = *M*. A solution of KMnO₄ which is normal as a salt would be 5-normal in a reaction with a ferrous salt whereby the Mn loses 5 valence charges, and would be 3-normal in a reaction whereby the KMnO₄ is only reduced to MnO₂.

Similarly the equivalent weight of potassium binoxalate, KHC₂O₄, or of potassium tetroxalate KHC₂O₄·H₂C₂O₄·2H₂O, depends upon the replaceable hydrogen when considered as an acid, but as reducing agents the carbon content alone is to be considered. A solution of tetroxalate which is normal as an acid is four-thirds normal as a reducing agent. Arsenic acid is like phosphoric acid as an acid, but in the reaction with hydriodic acid the As is reduced from the quinquevalent to the trivalent state (cf. pp. 530-532).

International Atomic Weights, 1919.

	Symbol.	Atomic Weight.		Symbol.	Atomic Weight
Aluminium.....	Al	27.1	Molybdenum.....	Mo	96.0
Antimony.....	Sb	120.2	Neodymium.....	Nd	144.3
Argon.....	A	39.88	Neon.....	Ne	20.2
Arsenic.....	As	74.96	Nickel.....	Ni	58.68
Barium.....	Ba	137.37	Niton (radium emanation).....	Nt	222.4
Bismuth.....	Bi	208.0	Nitrogen.....	N	14.01
Boron.....	B	11.0	Osmium.....	Os	190.9
Bromine.....	Br	79.92	Oxygen.....	O	16.00
Cadmium.....	Cd	112.40	Palladium.....	Pd	106.7
Caesium.....	Cs	132.81	Phosphorus.....	P	31.04
Calcium.....	Ca	40.07	Platinum.....	Pt	195.2
Carbon.....	C	12.05	Potassium.....	K	39.10
Cerium.....	Ce	140.25	Praseodymium....	Pr	140.9
Chlorine.....	Cl	35.46	Radium.....	Ra	226.0
Chromium.....	Cr	52.0	Rhodium.....	Rh	102.9
Cobalt.....	Co	58.97	Rubidium.....	Rb	85.45
Columbium.....	Cb	93.1	Ruthenium.....	Ru	101.7
Copper.....	Cu	63.57	Samarium.....	Sa	150.4
Dysprosium.....	Dy	162.5	Scandium.....	Sc	44.1
Erbium.....	Er	167.7	Selenium.....	Se	79.2
Europium.....	Eu	152.0	Silicon.....	Si	28.3
Fluorine.....	F	19.0	Silver.....	Ag	107.88
Gadolinium.....	Gd	157.3	Sodium.....	Na	23.00
Gallium.....	Ga	69.9	Strontium.....	Sr	87.63
Germanium.....	Ge	72.5	Sulfur.....	S	32.06
Glucinum*.....	Gl	9.1	Tantalum.....	Ta	181.5
Gold.....	Au	197.2	Tellurium.....	Te	127.5
Helium.....	He	4.0	Terbium.....	Tb	159.2
Holmium.....	Ho	163.5	Thallium.....	Tl	204.0
Hydrogen.....	H	1.008	Thorium.....	Th	232.4
Indium.....	In	114.8	Thulium.....	Tm	168.5
Iodine.....	I	126.92	Tin.....	Sn	118.7
Iridium.....	Ir	193.1	Titanium.....	Ti	48.1
Iron.....	Fe	55.84	Tungsten.....	W	184.0
Krypton.....	Kr	82.92	Uranium.....	U	238.2
Lanthanum.....	La	139.0	Vanadium.....	V	51.0
Lead.....	Pb	207.20	Xenon.....	Xe	130.2
Lithium.....	Li	6.94	Ytterbium.....	Yb	173.5
Lutecium.....	Lu	175.0	(Neoytterbium)..	Yb	173.5
Magnesium.....	Mg	24.32	Yttrium.....	Yt	88.7
Manganese.....	Mn	54.93	Zinc.....	Zn	65.3
Mercury.....	Hg	200.6	Zirconium.....	Zr	90.6

* Also called *Beryllium*.

Table of Chemical Factors.

Sought.	Found.	Factor.	Log.*	Sought	Found.	Factor.	Log.
Ag	AgCl	0.75262	1.87658	BaO	BaSO ₄	0.65700	1.81757
	AgBr	0.57444	1.75925		BaCrO ₄	0.60532	1.78199
	AgI	0.45946	1.66224		BaSiF ₆	0.54840	1.73909
Ag ₂ O	AgCl	0.80843	1.90764	Bi	Bi ₂ O ₃	0.89654	1.95258
Al	Al ₂ O ₃	0.53033	1.72455		BiAsO ₄	0.59942	1.77773
	AlPO ₄	0.22195	1.34625	Bi ₂ O ₃	Bi	1.1154	2.04743
Al ₂ O ₃	AlPO ₄	0.41851	1.62171	Br	Ag	0.74082	1.86971
					AgBr	0.42556	1.62896
AgCl	0.55755	1.74629					
As	As ₂ S ₃	0.60911	1.78470	C	CC ₂	0.27273	1.43573
	As ₂ S ₅	0.48319	1.68412		CO ₃	CC ₂	1.3636
	Mg ₂ As ₂ O ₇	0.48269	1.68371	Ca	CaO	0.71464	1.85409
	Mg ₂ P ₂ O ₇	0.67313	1.82810		CaCO ₃	0.40045	1.60252
As ₂ C ₃	As ₂ S ₃	0.80405	1.90528		CaSO ₄	0.29440	1.46893
	As ₂ S ₅	0.63783	1.80471		CaF ₂	0.51326	1.71034
	Mg ₂ As ₂ C ₇	0.63724	1.86430	CaO	CaCO ₃	0.56031	1.74843
Mg ₂ P ₂ C ₇	0.88865	1.94873	CaSO ₄		0.41195	1.61485	
CaF ₂	0.71820	1.85625					
AsC ₃	As ₂ S ₃	0.99915	1.99963	Cd	CdS	0.77801	1.89099
	As ₂ S ₅	0.79260	1.89905		CdO	0.87539	1.94220
	Mg ₂ As ₂ C ₇	0.79186	1.89865		CdSO ₄	0.53919	1.73174
	Mg ₂ P ₂ C ₇	1.1042	2.04304	CdO	CdS	0.88877	1.94879
As ₂ O ₅	As ₂ S ₃	0.93414	1.97041		Cd	1.14235	2.05780
	As ₂ S ₅	0.74103	1.86984		CdSO ₄	0.61591	1.78952
	Mg ₂ As ₂ C ₇	0.74034	1.86943	CdS	Cd	1.2853	2.10901
	Mg ₂ P ₂ C ₇	1.0323	2.01382		CdO	1.1252	2.05121
CdSO ₄	0.69300	1.84073					
AsO ₄	As ₂ S ₃	1.1292	2.05276	Cl	AgCl	0.24738	1.39337
	As ₂ S ₅	0.89574	1.95218		Ag	0.32870	1.51680
	Mg ₂ As ₂ C ₇	0.89490	1.95178	ClH	AgCl	0.25442	1.40555
	Mg ₂ P ₂ O ₇	1.2477	2.09616		Ag	0.33804	1.52898
B	B ₂ O ₃	0.31428	1.49732	ClO ₃	AgCl	0.58225	1.76511
	BO ₂	1.2286	2.08940		KCl	1.1194	2.04897
	BO ₃	1.6857	2.22678		NaCl	1.4276	2.15462
	B ₄ O ₇	1.1143	2.04700				
Ba	BaSO ₄	0.58846	1.76973				
	BaCrO ₄	0.54217	1.73414				
	BaSiF ₆	0.49119	1.69125				

* In this column the logarithm of the factor multiplied by 100 is given. The logarithms are given to five decimal places, but it should be borne in mind that the fourth decimal place is in most cases doubtful. Four-place logarithms are accurate enough for nearly all chemical analyses. The atomic weights for 1915 are used in these tables.

Table of Chemical Factors—Continued.

Sought.	Found.	Factor.	Log.	Sought	Found.	Factor.	Log.	
Mo	MoO ₃	0.66667	1.82391	NO ₂	NO	1.5332	2.18559	
N	NH ₃	0.82247	1.91512	N ₂ O ₃	NO	1.2666	2.10263	
	NH ₄ Cl	0.26187	1.41808		P	Mg ₂ P ₂ O ₇	0.27874	1.44519
	(NH ₄) ₂ PtCl ₆	0.06310	0.80005	P ₂ O ₅ , 24MoO ₃		0.01725	0.23688	
	Pt	0.14354	1.15699	(NH ₄) ₃ PO ₄ , 12MoO ₃		0.01654	0.21842	
Na	NaCl	0.39343	1.59487	PO ₄		Mg ₂ P ₂ O ₇	0.85345	1.93118
Na ₂ O	Na ₂ SO ₄	0.32378	1.51026		P ₂ O ₅ , 24MoO ₃	0.05283	0.72287	
	NaCl	0.53028	1.72450		(NH ₄) ₃ PO ₄ , 12MoO ₃	0.05063	0.70440	
NH ₃	Na ₂ SO ₄	0.43640	1.63989	P ₂ O ₅	Mg ₂ P ₂ O ₇	0.63793	1.80477	
	NH ₄ Cl	0.31821	1.50271		P ₂ O ₅ , 24MoO ₃	0.03947	0.59628	
	(NH ₄) ₂ PtCl ₆	0.07670	0.88483		(NH ₄) ₃ PO ₄ , 12MoO ₃	0.03785	0.57800	
Pt	0.17449	1.24177	Pb		PbO	0.92828	1.96768	
NH ₄	NH ₃	1.0592		2.02497	PbO ₂	0.86616	1.93760	
	NH ₄ Cl	0.33723		1.52793	PbS	0.86591	1.93747	
	(NH ₄) ₂ PtCl ₆	0.08125		0.90985	PbSO ₄	0.68312	1.83449	
NH ₄ Cl	Pt	0.18484		1.26679	PbCrO ₄	0.64098	1.80684	
	NH ₃	3.1409		2.49705	PbCl ₂	0.74491	1.87210	
	(NH ₄) ₂ PtCl ₆	0.24097	1.38196	PbO	PbO ₂	0.93308	1.96992	
Pt	0.54815	1.73890	PbS		0.93281	1.96979		
Ni	NiO	0.78576	1.89529		PbSO ₄	0.73589	1.86681	
	NiC ₈ H ₁₄ N ₄ O ₄	0.20316	1.30785		PbCrO ₄	0.69050	1.83916	
NiO	Ni	1.2727	2.10471		PbCl ₂	0.80246	1.90442	
	NiC ₈ H ₁₄ N ₄ O ₄	0.25856	1.41256		S	BaSO ₄	0.13738	1.13792
NO ₃	NO	2.0663	2.31520	SO ₂		BaSO ₄	0.27446	1.43848
	NH ₃	3.6404	2.56115	SO ₂		BaSO ₄	0.34300	1.53530
	NH ₄ Cl	1.1591	1.06411	SO ₄		BaSO ₄	0.41154	1.61441
	(NH ₄) ₂ PtCl ₆	0.27930	1.44607	SO ₄ H ₂		BaSO ₄	0.42018	1.62343
	Pt	0.63535	1.80301	H ₂ S		BaSO ₄	0.14602	1.16443
C ₂₀ H ₁₇ N ₅ O ₃	0.16528	1.21823	FeS ₂	BaSO ₄		0.25700	1.40994	
NO ₃ H	NO	2.0999	2.32220	Sb		Sb ₂ O ₄	0.78975	1.89749
	NH ₃	3.6995	2.56815		Sb ₂ S ₃	0.71418	1.85381	
	NH ₄ Cl	1.1779	2.07111	Si	SiO ₂	0.46931	1.67147	
	(NH ₄) ₂ PtCl ₆	0.28385	1.45309		SiO ₃	1.2653	2.10221	
	Pt	0.64570	1.81003	Sn	SnO ₂	0.78808	1.89657	
	C ₂₀ H ₁₇ N ₅ O ₃	0.16797	1.22523		Sn	1.2689	2.10343	
N ₂ O ₅	NO	1.7997	2.25521	Sr	SrO	0.84560	1.92717	
	NH ₃	3.1707	2.50116		SrCO ₃	0.59353	1.77348	
	NH ₄ Cl	1.0095	2.00412		SrSO ₄	0.47703	1.67854	
	(NH ₄) ₂ PtCl ₆	0.24327	1.38608		Sr(NO ₃) ₂	0.41403	1.61703	
	Pt	0.55338	1.74302					
	C ₂₀ H ₁₇ N ₅ O ₃	0.14396	1.15824					

Table of Chemical Factors—Concluded.

Sought.	Found.	Factor.	Log.	Sought.	Found.	Factor.	Log.
SrO	SrCO ₃	0.70196	1.84631	W	WO ₃	0.79310	1.89933
	SrSO ₄	0.56413	1.75138		WO ₃	W	1.2609
	Sr(NO ₃) ₂	0.48963	1.68987	Zn	ZnO	0.80337	1.90491
Th	ThO ₂	0.87898	1.94398		ZnS	0.67087	1.82664
					ZnNH ₄ PO ₄	0.36632	1.56386
Ti	TiO ₂	0.60051	1.77852		Zn ₂ P ₂ O ₇	0.42891	1.63237
				U	U ₃ O ₈	0.84824	1.92852
UO ₂	0.88170	1.94532	ZnNH ₄ PO ₄		0.45598	1.65895	
(UO ₂) ₂ P ₂ O ₇	0.66703	1.82415	Zn ₂ P ₂ O ₇		0.53390	1.72746	
V	V ₂ O ₅	0.56044	1.74853	Zr	ZrO ₂	0.73899	1.86864

Natural Numbers.											PROPORTIONAL PARTS.									
	0	1	2	3	4	5	6	7	8	9	1	2	3	4	5	6	7	8	9	
	10	0000	0043	0086	0128	0170	0212	0253	0294	0334	0374	4	8	12	17	21	25	29	33	37
11	0414	0453	0492	0531	0569	0607	0645	0682	0719	0755	4	8	11	15	19	23	26	30	34	
12	0792	0828	0864	0899	0934	0969	1004	1038	1072	1106	3	7	10	14	17	21	24	28	31	
13	1139	1173	1206	1239	1271	1303	1335	1367	1399	1430	3	6	10	13	16	19	23	26	29	
14	1461	1492	1523	1553	1584	1614	1644	1673	1703	1732	3	6	9	12	15	18	21	24	27	
15	1761	1790	1818	1847	1875	1903	1931	1959	1987	2014	3	6	8	11	14	17	20	22	25	
16	2041	2068	2095	2122	2148	2175	2201	2227	2253	2279	3	5	8	11	13	16	18	21	24	
17	2304	2330	2355	2380	2405	2430	2455	2480	2504	2529	2	5	7	10	12	15	17	20	22	
18	2553	2577	2601	2625	2648	2672	2695	2718	2742	2765	2	5	7	9	12	14	16	19	21	
19	2788	2810	2833	2856	2878	2900	2923	2945	2967	2989	2	4	7	9	11	13	16	18	20	
20	3010	3032	3054	3075	3096	3118	3139	3160	3181	3201	2	4	6	8	11	13	15	17	19	
21	3222	3243	3263	3284	3304	3324	3345	3365	3385	3404	2	4	6	8	10	12	14	16	18	
22	3424	3444	3464	3483	3502	3522	3541	3560	3579	3598	2	4	6	8	10	12	14	15	17	
23	3617	3636	3655	3674	3692	3711	3729	3747	3766	3784	2	4	6	7	9	11	13	15	17	
24	3802	3820	3838	3856	3874	3892	3909	3927	3945	3962	2	4	5	7	9	11	12	14	16	
25	3979	3997	4014	4031	4048	4065	4082	4099	4116	4133	2	3	5	7	9	10	12	14	15	
26	4150	4166	4183	4200	4216	4232	4249	4265	4281	4298	2	3	5	7	8	10	11	13	15	
27	4314	4330	4346	4362	4378	4393	4409	4425	4440	4456	2	3	5	6	8	9	11	13	14	
28	4472	4487	4502	4518	4533	4548	4564	4579	4594	4609	2	3	5	6	8	9	11	12	14	
29	4624	4639	4654	4669	4683	4698	4713	4728	4742	4757	1	3	4	6	7	9	10	12	13	
30	4771	4786	4800	4814	4829	4843	4857	4871	4886	4900	1	3	4	6	7	9	10	11	13	
31	4914	4928	4942	4955	4969	4983	4997	5011	5024	5038	1	3	4	6	7	8	10	11	12	
32	5051	5065	5079	5092	5105	5119	5132	5145	5159	5172	1	3	4	5	7	8	9	11	12	
33	5185	5198	5211	5224	5237	5250	5263	5276	5289	5302	1	3	4	5	6	8	9	10	12	
34	5315	5328	5340	5353	5366	5378	5391	5403	5416	5428	1	3	4	5	6	8	9	10	11	
35	5441	5453	5465	5478	5490	5502	5514	5527	5539	5551	1	2	4	5	6	7	9	10	11	
36	5563	5575	5587	5599	5611	5623	5635	5647	5658	5670	1	2	4	5	6	7	8	10	11	
37	5632	5694	5705	5717	5729	5740	5752	5763	5775	5786	1	2	3	5	6	7	8	9	10	
38	5798	5809	5821	5832	5843	5855	5866	5877	5888	5899	1	2	3	5	6	7	8	9	10	
39	5911	5922	5933	5944	5955	5966	5977	5988	5999	6010	1	2	3	4	5	7	8	9	10	
40	6021	6031	6042	6053	6064	6075	6085	6096	6107	6117	1	2	3	4	5	6	8	9	10	
41	6128	6138	6149	6160	6170	6180	6191	6201	6212	6222	1	2	3	4	5	6	7	8	9	
42	6232	6243	6253	6263	6274	6284	6294	6304	6314	6325	1	2	3	4	5	6	7	8	9	
43	6335	6345	6355	6365	6375	6385	6395	6405	6415	6425	1	2	3	4	5	6	7	8	9	
44	6435	6444	6454	6464	6474	6484	6493	6503	6513	6522	1	2	3	4	5	6	7	8	9	
45	6532	6542	6551	6561	6571	6580	6590	6599	6609	6618	1	2	3	4	5	6	7	8	9	
46	6628	6637	6646	6656	6665	6675	6684	6693	6702	6712	1	2	3	4	5	6	7	8	9	
47	6721	6730	6739	6749	6758	6767	6776	6785	6794	6803	1	2	3	4	5	6	7	8	9	
48	6812	6821	6830	6839	6848	6857	6866	6875	6884	6893	1	2	3	4	5	6	7	8	9	
49	6902	6911	6920	6928	6937	6946	6955	6964	6972	6981	1	2	3	4	5	6	7	8	9	
50	6990	6998	7007	7016	7024	7033	7042	7050	7059	7067	1	2	3	3	4	5	6	7	8	
51	7076	7084	7093	7101	7110	7118	7126	7135	7143	7152	1	2	3	3	4	5	6	7	8	
52	7160	7168	7177	7185	7193	7202	7210	7218	7226	7235	1	2	3	4	5	6	7	8	9	
53	7243	7251	7259	7267	7275	7284	7292	7300	7308	7316	1	2	2	3	4	5	6	7	8	
54	7324	7332	7340	7348	7356	7364	7372	7380	7388	7396	1	2	2	3	4	5	6	6	7	

Natural Numbers.											PROPORTIONAL PARTS.								
	0	1	2	3	4	5	6	7	8	9	1	2	3	4	5	6	7	8	6
	55	7404	7412	7419	7427	7435	7443	7451	7459	7466	7474	1	2	2	3	4	5	5	6
56	7482	7490	7497	7505	7513	7520	7528	7536	7543	7551	1	2	2	3	4	5	5	6	7
57	7559	7566	7574	7582	7589	7597	7604	7612	7619	7627	1	2	2	3	4	5	5	6	7
58	7634	7642	7649	7657	7664	7672	7679	7686	7694	7701	1	1	2	3	4	4	5	6	7
59	7709	7716	7723	7731	7738	7745	7752	7760	7767	7774	1	1	2	3	4	4	5	6	7
60	7782	7789	7796	7803	7810	7818	7825	7832	7839	7846	1	1	2	3	4	4	5	6	6
61	7853	7860	7868	7875	7882	7889	7896	7903	7910	7917	1	1	2	3	4	4	5	6	6
62	7924	7931	7938	7945	7952	7959	7966	7973	7980	7987	1	1	2	3	3	4	5	6	6
63	7993	8000	8007	8014	8021	8028	8035	8041	8048	8055	1	1	2	3	3	4	5	5	6
64	8062	8069	8075	8082	8089	8096	8102	8109	8116	8122	1	1	2	3	3	4	5	5	6
65	8129	8136	8142	8149	8156	8162	8169	8176	8182	8189	1	1	2	3	3	4	5	5	6
66	8195	8202	8209	8215	8222	8228	8235	8241	8248	8254	1	1	2	3	3	4	5	5	6
67	8261	8267	8274	8280	8287	8293	8299	8306	8312	8319	1	1	2	3	3	4	5	5	6
68	8325	8331	8338	8344	8351	8357	8363	8370	8376	8382	1	1	2	3	3	4	4	5	6
69	8388	8395	8401	8407	8414	8420	8426	8432	8439	8445	1	1	2	2	3	4	4	5	6
70	8451	8457	8463	8470	8476	8482	8488	8494	8500	8506	1	1	2	2	3	4	4	5	6
71	8513	8519	8525	8531	8537	8543	8549	8555	8561	8567	1	1	2	2	3	4	4	5	5
72	8573	8579	8585	8591	8597	8603	8609	8615	8621	8627	1	1	2	2	3	4	4	5	5
73	8633	8639	8645	8651	8657	8663	8669	8675	8681	8686	1	1	2	2	3	4	4	5	5
74	8692	8698	8704	8710	8716	8722	8727	8733	8739	8745	1	1	2	2	3	4	4	5	5
75	8751	8756	8762	8768	8774	8779	8785	8791	8797	8802	1	1	2	2	3	3	4	5	5
76	8808	8814	8820	8825	8831	8837	8842	8848	8854	8859	1	1	2	2	3	3	4	5	5
77	8865	8871	8876	8882	8887	8893	8899	8904	8910	8915	1	1	2	2	3	3	4	4	5
78	8921	8927	8932	8938	8943	8949	8954	8960	8965	8971	1	1	2	2	3	3	4	4	5
79	8976	8982	8987	8993	8998	9004	9009	9015	9020	9025	1	1	2	2	3	3	4	4	5
80	9031	9036	9042	9047	9053	9058	9063	9069	9074	9079	1	1	2	2	3	3	4	4	5
81	9085	9090	9096	9101	9106	9112	9117	9122	9128	9133	1	1	2	2	3	3	4	4	5
82	9138	9143	9149	9154	9159	9165	9170	9175	9180	9186	1	1	2	2	3	3	4	4	5
83	9191	9196	9201	9206	9212	9217	9222	9227	9232	9238	1	1	2	2	3	3	4	4	5
84	9243	9248	9253	9258	9263	9269	9274	9279	9284	9289	1	1	2	2	3	3	4	4	5
85	9294	9299	9304	9309	9315	9320	9325	9330	9335	9340	1	1	2	2	3	3	4	4	5
86	9345	9350	9355	9360	9365	9370	9375	9380	9385	9390	1	1	2	2	3	3	4	4	5
87	9395	9400	9405	9410	9415	9420	9425	9430	9435	9440	0	1	1	2	2	3	3	4	4
88	9445	9450	9455	9460	9465	9469	9474	9479	9484	9489	0	1	1	2	2	3	3	4	4
89	9494	9499	9504	9509	9513	9518	9523	9528	9533	9538	0	1	1	2	2	3	3	4	4
90	9542	9547	9552	9557	9562	9566	9571	9576	9581	9586	0	1	1	2	2	3	3	4	4
91	9590	9595	9600	9605	9609	9614	9619	9624	9628	9633	0	1	1	2	2	3	3	4	4
92	9638	9643	9647	9652	9657	9661	9666	9671	9675	9680	0	1	1	2	2	3	3	4	4
93	9685	9689	9694	9699	9703	9708	9713	9717	9722	9727	0	1	1	2	2	3	3	4	4
94	9731	9736	9741	9745	9750	9754	9759	9763	9768	9773	0	1	1	2	2	3	3	4	4
95	9777	9782	9786	9791	9795	9800	9805	9809	9814	9818	0	1	1	2	2	3	3	4	4
96	9823	9827	9832	9836	9841	9845	9850	9854	9859	9863	0	1	1	2	2	3	3	4	4
97	9868	9872	9877	9881	9886	9890	9894	9899	9903	9908	0	1	1	2	2	3	3	4	4
98	9912	9917	9921	9926	9930	9934	9939	9943	9948	9952	0	1	1	2	2	3	3	4	4
99	9956	9961	9965	9969	9974	9978	9983	9987	9991	9996	0	1	1	2	2	3	3	4	4

Logarithms.											PROPORTIONAL PARTS.								
	0	1	2	3	4	5	6	7	8	9	1	2	3	4	5	6	7	8	9
.00	1000	1002	1005	1007	1009	1012	1014	1016	1019	1021	0	0	1	1	1	1	2	2	2
.01	1023	1026	1028	1030	1033	1035	1038	1040	1042	1045	0	0	1	1	1	1	2	2	2
.02	1047	1050	1052	1054	1057	1059	1062	1064	1067	1069	0	0	1	1	1	1	2	2	2
.03	1072	1074	1076	1079	1081	1084	1086	1089	1091	1094	0	0	1	1	1	1	2	2	2
.04	1096	1099	1102	1104	1107	1109	1112	1114	1117	1119	0	1	1	1	1	2	2	2	2
.05	1122	1125	1127	1130	1132	1135	1138	1140	1143	1146	0	1	1	1	1	2	2	2	2
.06	1148	1151	1153	1156	1159	1161	1164	1167	1169	1172	0	1	1	1	1	2	2	2	2
.07	1175	1178	1180	1183	1186	1189	1191	1194	1197	1199	0	1	1	1	1	2	2	2	2
.08	1202	1205	1208	1211	1213	1216	1219	1222	1225	1227	0	1	1	1	1	2	2	2	3
.09	1230	1233	1236	1239	1242	1245	1247	1250	1253	1256	0	1	1	1	1	2	2	2	3
.10	1259	1262	1265	1268	1271	1274	1276	1279	1282	1285	0	1	1	1	1	2	2	2	3
.11	1288	1291	1294	1297	1300	1303	1306	1309	1312	1315	0	1	1	1	2	2	2	2	3
.12	1318	1321	1324	1327	1330	1334	1337	1340	1343	1346	0	1	1	1	2	2	2	2	3
.13	1349	1352	1355	1358	1361	1365	1368	1371	1374	1377	0	1	1	1	2	2	2	3	3
.14	1380	1384	1387	1390	1393	1396	1400	1403	1406	1409	0	1	1	1	2	2	2	3	3
.15	1413	1416	1419	1422	1426	1429	1432	1435	1439	1442	0	1	1	1	2	2	2	3	3
.16	1445	1449	1452	1455	1459	1462	1466	1469	1472	1476	0	1	1	1	2	2	2	3	3
.17	1479	1483	1486	1489	1493	1496	1500	1503	1507	1510	0	1	1	1	2	2	2	3	3
.18	1514	1517	1521	1524	1528	1531	1535	1538	1542	1545	0	1	1	1	2	2	2	3	3
.19	1549	1552	1556	1560	1563	1567	1570	1574	1578	1581	0	1	1	1	2	2	3	3	3
.20	1585	1589	1592	1596	1600	1603	1607	1611	1614	1618	0	1	1	1	2	2	3	3	3
.21	1622	1626	1629	1633	1637	1641	1644	1648	1652	1656	0	1	1	2	2	2	3	3	3
.22	1660	1663	1667	1671	1675	1679	1683	1687	1690	1694	0	1	1	2	2	2	3	3	3
.23	1698	1702	1706	1710	1714	1718	1722	1726	1730	1734	0	1	1	2	2	2	3	3	4
.24	1738	1742	1746	1750	1754	1758	1762	1766	1770	1774	0	1	1	2	2	2	3	3	4
.25	1778	1782	1786	1791	1795	1799	1803	1807	1811	1816	0	1	1	2	2	2	3	3	4
.26	1820	1824	1828	1832	1837	1841	1845	1849	1854	1858	0	1	1	2	2	3	3	3	4
.27	1862	1866	1871	1875	1879	1884	1888	1892	1897	1901	0	1	1	2	2	3	3	3	4
.28	1905	1910	1914	1919	1923	1928	1932	1936	1941	1945	0	1	1	2	2	3	3	4	4
.29	1950	1954	1959	1963	1968	1972	1977	1982	1986	1991	0	1	1	2	2	3	3	4	4
.30	1995	2000	2004	2009	2014	2018	2023	2028	2032	2037	0	1	1	2	2	3	3	4	4
.31	2042	2046	2051	2056	2061	2065	2070	2075	2080	2084	0	1	1	2	2	3	3	4	4
.32	2089	2094	2099	2104	2109	2113	2118	2123	2128	2133	0	1	1	2	2	3	3	4	4
.33	2138	2143	2148	2153	2158	2163	2168	2173	2178	2183	0	1	1	2	2	3	3	4	4
.34	2188	2193	2198	2203	2208	2213	2218	2223	2228	2234	1	1	2	2	3	3	4	4	5
.35	2239	2244	2249	2254	2259	2265	2270	2275	2280	2286	1	1	2	2	3	3	4	4	5
.36	2291	2296	2301	2307	2312	2317	2323	2328	2333	2339	1	1	2	2	3	3	4	4	5
.37	2344	2350	2355	2360	2366	2371	2377	2382	2388	2393	1	1	2	2	3	3	4	4	5
.38	2399	2404	2410	2415	2421	2427	2432	2438	2443	2449	1	1	2	2	3	3	4	4	5
.39	2455	2460	2466	2472	2477	2483	2489	2495	2500	2506	1	1	2	2	3	3	4	4	5
.40	2512	2518	2523	2529	2535	2541	2547	2553	2559	2564	1	1	2	2	3	3	4	4	5
.41	2570	2576	2582	2588	2594	2600	2606	2612	2618	2624	1	1	2	2	3	3	4	4	5
.42	2630	2636	2642	2649	2655	2661	2667	2673	2679	26 5	1	1	2	2	3	3	4	4	5
.43	2692	2698	2704	2710	2716	2723	2729	2735	2742	2748	1	1	2	2	3	3	4	4	5
.44	2754	2761	2767	2773	2780	2786	2793	2799	2805	2812	1	1	2	2	3	3	4	4	5
.45	2818	2825	2831	2838	2844	2851	2858	2864	2871	2877	1	1	2	2	3	3	4	4	5
.46	2884	2891	2897	2904	2911	2917	2924	2931	2938	2944	1	1	2	2	3	3	4	4	5
.47	2951	2958	2965	2972	2979	2985	2992	2999	3006	3013	1	1	2	2	3	3	4	4	5
.48	3020	3027	3034	3041	3048	3055	3062	3069	3076	3083	1	1	2	2	3	3	4	4	5
.49	3090	3097	3105	3112	3119	3126	3133	3141	3148	3155	1	1	2	2	3	3	4	4	5

Logarithms.											PROPORTIONAL PARTS.									
	0	1	2	3	4	5	6	7	8	9	1	2	3	4	5	6	7	8	9	
	.50	3162	3170	3177	3184	3192	3199	3206	3214	3221	3228	1	1	2	3	4	4	5	6	7
.51	3236	3243	3251	3258	3266	3273	3281	3289	3296	3304	1	2	2	3	4	5	5	6	7	
.52	3311	3319	3327	3334	3342	3350	3357	3365	3373	3381	1	2	2	3	4	5	5	6	7	
.53	3388	3396	3404	3412	3420	3428	3436	3443	3451	3459	1	2	2	3	4	5	6	6	7	
.54	3467	3475	3483	3491	3499	3508	3516	3524	3532	3540	1	2	2	3	4	5	6	6	7	
.55	3548	3556	3565	3573	3581	3589	3597	3606	3614	3622	1	2	2	3	4	5	6	7	7	
.56	3631	3639	3648	3656	3664	3673	3681	3690	3698	3707	1	2	3	3	4	5	6	7	8	
.57	3715	3724	3733	3741	3750	3758	3767	3776	3784	3793	1	2	3	3	4	5	6	7	8	
.58	3802	3811	3819	3828	3837	3846	3855	3864	3873	3882	1	2	3	4	4	5	6	7	8	
.59	3890	3899	3908	3917	3926	3936	3945	3954	3963	3972	1	2	3	4	5	6	7	8	8	
.60	3981	3990	3999	4009	4018	4027	4036	4046	4055	4064	1	2	3	4	5	6	6	7	8	
.61	4074	4083	4093	4102	4111	4121	4130	4140	4150	4159	1	2	3	4	5	6	7	8	9	
.62	4169	4178	4188	4198	4207	4217	4227	4236	4246	4256	1	2	3	4	5	6	7	8	9	
.63	4266	4276	4285	4295	4305	4315	4325	4335	4345	4355	1	2	3	4	5	6	7	8	9	
.64	4365	4375	4385	4395	4406	4416	4426	4436	4446	4457	1	2	3	4	5	6	7	8	9	
.65	4467	4477	4487	4498	4508	4519	4529	4539	4550	4560	1	2	3	4	5	6	7	8	9	
.66	4571	4581	4592	4603	4613	4624	4634	4645	4656	4667	1	2	3	4	5	6	7	9	10	
.67	4677	4688	4699	4710	4721	4732	4742	4753	4764	4775	1	2	3	4	5	7	8	9	10	
.68	4786	4797	4808	4819	4831	4842	4853	4864	4875	4887	1	2	3	4	6	7	8	9	10	
.69	4898	4909	4920	4932	4943	4955	4966	4977	4989	5000	1	2	3	5	6	7	8	9	10	
.70	5012	5023	5035	5047	5058	5070	5082	5093	5105	5117	1	2	4	5	6	7	8	9	11	
.71	5129	5140	5152	5164	5176	5188	5200	5212	5224	5236	1	2	4	5	6	7	8	10	11	
.72	5248	5260	5272	5284	5297	5309	5321	5333	5346	5358	1	2	4	5	6	7	9	10	11	
.73	5370	5383	5395	5408	5420	5433	5445	5458	5470	5483	1	3	4	5	6	8	9	10	11	
.74	5495	5508	5521	5534	5546	5559	5572	5585	5598	5610	1	3	4	5	6	8	9	10	12	
.75	5623	5636	5649	5662	5675	5689	5702	5715	5728	5741	1	3	4	5	7	8	9	10	12	
.76	5754	5768	5781	5794	5808	5821	5834	5848	5861	5875	1	3	4	5	7	8	9	11	12	
.77	5888	5902	5916	5929	5943	5957	5970	5984	5998	6012	1	3	4	5	7	8	10	11	12	
.78	6026	6039	6053	6067	6081	6095	6109	6124	6138	6152	1	3	4	6	7	8	10	11	13	
.79	6166	6180	6194	6209	6223	6237	6252	6266	6281	6295	1	3	4	6	7	9	10	11	13	
.80	6310	6324	6339	6353	6368	6383	6397	6412	6427	6442	1	3	4	6	7	9	10	12	13	
.81	6457	6471	6486	6501	6516	6531	6546	6561	6577	6592	2	3	5	6	8	9	11	12	14	
.82	6607	6622	6637	6653	6668	6683	6699	6714	6730	6745	2	3	5	6	8	9	11	12	14	
.83	6761	6776	6792	6808	6823	6839	6855	6871	6887	6902	2	3	5	6	8	9	11	12	14	
.84	6918	6934	6950	6966	6982	6998	7015	7031	7047	7063	2	3	5	6	8	10	11	13	15	
.85	7079	7096	7112	7129	7145	7161	7178	7194	7211	7228	2	3	5	7	8	10	12	13	15	
.86	7244	7261	7278	7295	7311	7328	7345	7362	7379	7396	2	3	5	7	8	10	12	13	15	
.87	7413	7430	7447	7464	7482	7499	7516	7534	7551	7568	2	3	5	7	9	10	12	14	16	
.88	7586	7603	7621	7638	7656	7674	7691	7709	7727	7745	2	4	5	7	9	11	12	14	16	
.89	7762	7780	7798	7816	7834	7852	7870	7889	7907	7925	2	4	5	7	9	11	13	14	16	
.90	7943	7962	7980	7998	8017	8035	8054	8072	8091	8110	2	4	6	7	9	11	13	15	17	
.91	8128	8147	8166	8185	8204	8222	8241	8260	8279	8299	2	4	6	8	9	11	13	15	17	
.92	8318	8337	8356	8375	8395	8414	8433	8453	8472	8492	2	4	6	8	10	12	14	15	17	
.93	8511	8531	8551	8570	8590	8610	8630	8650	8670	8690	2	4	6	8	10	12	14	16	18	
.94	8710	8730	8750	8770	8790	8810	8831	8851	8872	8892	2	4	6	8	10	12	14	16	18	
.95	8913	8933	8954	8974	8995	9016	9036	9057	9078	9099	2	4	6	8	10	12	15	17	19	
.96	9120	9141	9162	9183	9204	9226	9247	9268	9290	9311	2	4	6	8	11	13	15	17	19	
.97	9333	9354	9376	9397	9419	9441	9462	9484	9506	9528	2	4	7	9	11	13	15	17	20	
.98	9550	9572	9594	9616	9638	9661	9683	9705	9727	9750	2	4	7	9	11	13	16	18	20	
.99	9772	9795	9817	9840	9863	9886	9908	9931	9954	9977	2	5	7	9	11	14	16	18	20	



INDICES.

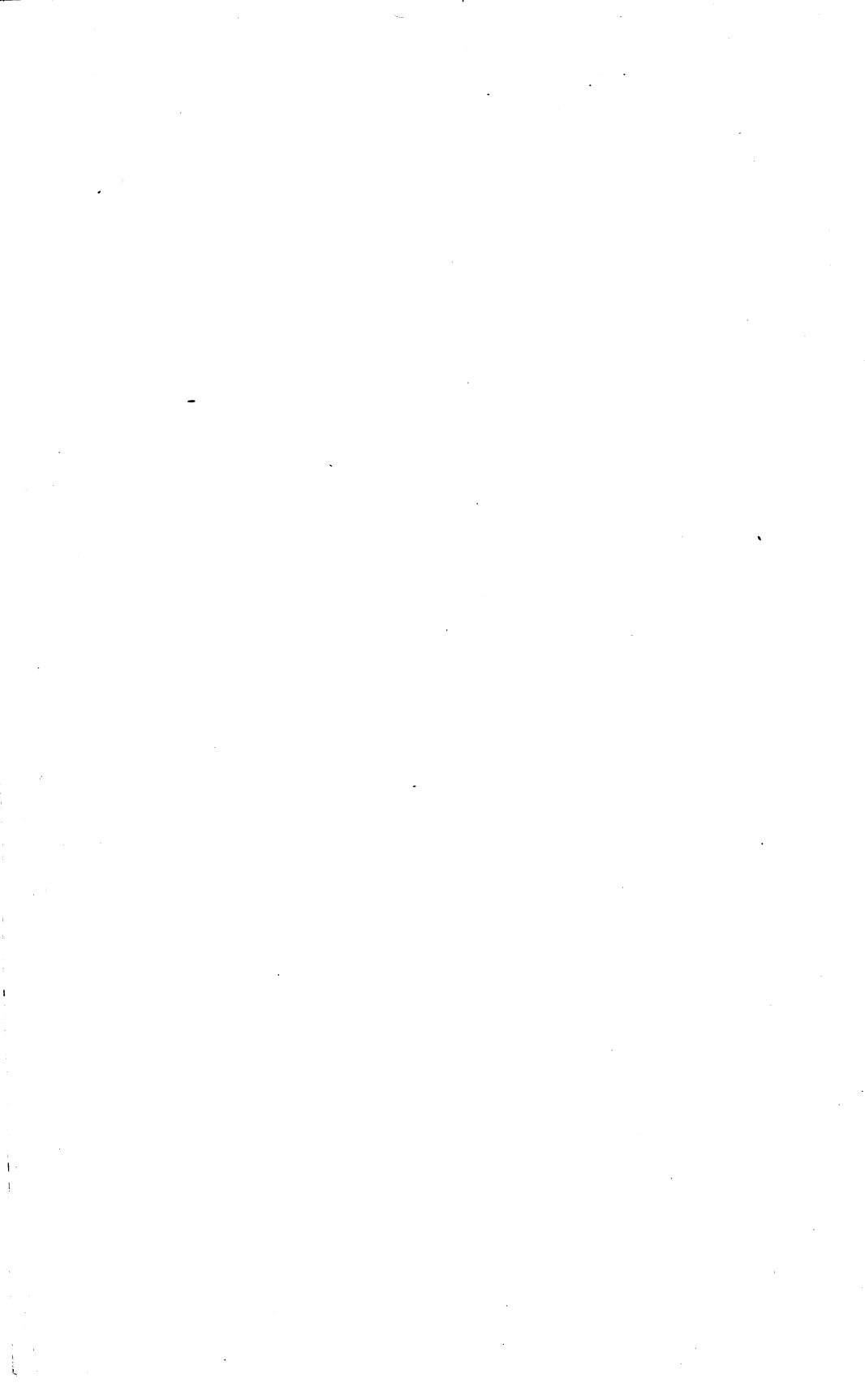

INDEX OF AUTHORS.

A.

	PAGE
Alefeld, E., Determination of chlorine.	708
Allner, Determination of carbon monoxide.	762
Andrew, L. W., Use of potassium iodate.	672
Andrews, Volumetric estimation of nickel.	720
sulphuric acid.	716
Anneler, Determination of ozone.	677
Arndt, Combustion of nitric oxide.	803
Arthur, Volumetric estimation of nickel.	720
Augenot, Separation of tungsten from tin.	300
Austin, M., Determination of magnesium.	66
manganese.	120, 126
zinc.	140

B.

Bamber, Method for determining sulphur in iron and steel.	354
Barnebey, O. L., Determination of titanium.	118
Baubigny, Determination of antimony.	222
Beckett, E. G.	223, 224
Beilstein, Electrolytic determination of cadmium.	189
Belhoubek, Volumetric determination of uranium.	621
Benz, Determination of thorium.	510
Bergmann, Electrolysis of nickel solutions.	131
Screen for reading burettes.	529
Berthelot, Absorption of benzene.	753
Distribution of iodine between two solvents.	658
Berzelius, Alkalies in silicates.	499
Mercurous tungstate precipitation.	289
Silicic acid precipitation.	473, 489
Vanadium determination.	304
Biltz, W., Separation of halides from sulphides.	329
Black, Colorimetric determination of arsenic.	208

	PAGE
Blair, A. A., Condition of sulphur in iron and steel	352
Direct combustion of steel	413
Manganese in steel, iron, ores, etc.	616
Phosphorus in iron and steel	637
Vanadium, molybdenum, chromium, and nickel in steel	313
Blasdale, W. C., Separation of calcium and magnesium	77
Bloxam, Electrolytic determination of arsenic	212
Böckmann, Sulphur in insoluble sulphides	358
Bong, G., Decomposition of silicates	490
Borchers, W., Sulphocyanic acid	341
and hydrocyanic acids	342
Borda, Method of weighing	9
Boreli, Electrolytic determination of mercury	173
Bormann, Expelling ammonia with magnesium oxide	59
Borntträger, H., Determination of tungsten	300
Recovery of molybdenum residues	447
Boudet, Error in measuring alcoholic soap solutions	536
Boutron, Error in measuring alcoholic soap solutions	536
Braun, Effect of carbon disulphide on antimony sulphide	242
Brauner, B., Separation of selenium and tellurium	279, 280
Brearily, Volumetric estimation of nickel	720
Bretschger, M., Density of acetylene	754
ethylene	751
Pipette for gas analysis	796
Preparation of acetylene	754
Brodie, B. C., Ozone	676
Bruhns, Volumetric estimation of sulphuric acid	716
Brunck, O., Combustion of hydrogen	772
Determination of antimony	222
nickel	129
Separation of iron and manganese	153
nickel	166
nickel and cobalt	162
zinc	165
Volumetric estimation of hydrogen sulphide	688
Brunner, Analysis of tungsten bronze	299
Determination of arsenic	205
Separation of zinc from nickel, cobalt, and manganese	158
Brush, Water in silicates	512
Bunsen, Alkalimeter	376
Analysis of chromite	509
Combustion of nitrogen	807
Determination of antimony	222
arsenic	205
Igniting precipitates	22

	PAGE
Bunsen, Iodimetric analysis of peroxides	661
Separation of arsenic and antimony	241
Solubility of nitrous oxide	801
Type of burette	514
Valve	87, 98, 601
Volumetric estimation of bromides	659
sulphurous acid	692
Bunte, Apparatus for gas analysis	798
Burgstaller, A., Determination of chlorine	708
Busch, M., Determination of nitric acid	451
Busvold, N., Analysis of gases rich in chlorine	810
Density of hydrogen chloride	814
Experiments with chlorine	812

C.

Campagne, Chromium in steel	315
Campbell, Absorption of hydrogen	771
Determination of nickel	720
Direct combustion of steel	413
Carius, Method for decomposing organic substances	325, 370
Carnot, A., Determination of lithium	56
Cavendish, Rare gases in commercial nitrogen	807
Chance, Determination of aluminium	83
Separation of iron and titanium	115
Chapin, W. H., Boric acid in silicates	590
Christensen, A., Metallic iron in the presence of oxide	612
Christie, W. A. K., Computations in gas analysis	782
Density of carbon dioxide	750
chlorine	808
Standardization of permanganate	98
Clarke, F. W., Electrolytic determination of mercury	172
Separation of antimony and tin	248
Classen, A., Determination of antimony	224, 226, 227
carbon dioxide	380
zinc	147
Electrolytic apparatus	134
determination of mercury	172
tin	234
Standardization of permanganate	92, 600
Comment, Colorimetric determination of arsenic	208
Contat, Valve	98, 602
Cooke, J. P., Ferrous iron in silicates	503
Corleis, Carbon in iron and steel	399
Cormimboef, H., Nickel determination	138

D.

	PAGE
Dakin, H. D., Determination of zinc	140
Daniel, D., Determination of iron	89
Davila, Density of nitric oxide	802
Deckert, Apparatus for chlorine determination	813
de Haën, Titration of ferrocyanic acid	632
de Koninck, Determination of ferrous iron	504
nitric acid	460
Dennis, Technical gas analysis	794
Dennstedt, M., Combustion in open tube	421
Deussen, E., Fusion with potassium acid fluoride	109
Devada, Determination of nitric acid	454
Deventer, Preparation of nitric oxide	802
Deville, St. Claire, Analysis of commercial platinum	272
Water-jacketed tube	732
Dexter, Determination of antimony	224
Diefenthaler, O., Volumetric estimation of ferrieyanic acid	695
Diehl, Volumetric analysis of lead peroxide	675
Diethelm, Burette float	529
Dietz, H., Analysis of iodides	671
Dittmar, Determination of potassium	45, 48
Ditz, H., Analysis of chlorates	669
Divers, E., Absorption of nitric oxide	803
Donath, Determination of ammonia	824
Separation of tungsten and tin	301
Dormaar, O. M. M., Determination of antimony	227
Drechsel, G., Volumetric estimation of chlorine	707
Drehschmidt, Analysis of gas mixtures	784
Apparatus for gas analysis	785
Pipette	743, 766
Platinum capillary	743, 766
Drouin, Qualitative detection of carbon monoxide	769
Drown, T. M., Determination of silicon in iron and steel	442
Dudley, Determination of phosphorus in bronze	239
Dulin, Determination of copper	724
Dumas, Method for determining nitrogen	422
Dupasquier, Volumetric estimation of sulphurous acid	692
Dupré, Determination of potassium	44, 45, 46, 48
Durkes, Benzidine hydrochloride	714
Duschak, Determination of sulphuric acid	465, 469

E.

Eddy, Determination of magnesium	69
Eggertz, Precipitation of ammonium phosphomolybdate	436
Emich, Determination of nitric oxide	802

	PAGE
Engel, Electrolytic determination of tin	235
Engels, Determination of potassium	48
Engler, Theory of oxidation	605
Erdmann, Determination of mercury	172
Euler, Separation of vanadic and molybdic acids	666, 667

F.

Fairbanks, Volumetric estimation of molybdenum	667, 668
Feldhaus, Gravimetric estimation of cyanogen	337
Ferchland, P., Determination of chlorine	812
Finch, G., Analysis of fuming sulphuric acid	577
Finkener, Determination of antimony	224
ferrocyanic acid	343
phosphoric acid	439
Precipitation of potassium	47
Volumetric estimation of sulphurous acid	692
Fischer, A., Determination of antimony	225, 227
E., Separation of arsenic and antimony	245
N. W., Separation of nickel and cobalt	162
Fitzenkam, R., Determination of potassium	51
Folin, O., Determination of sulphuric acid	469
Follenius, Determination of cadmium	191
Fones, Determination of boric acid	428
Fordos, Volumetric estimation of sulphurous acid	692
Förster, F., Analysis of ferrum reductum	612
Electrolytic deposition of copper	187
Determination of antimony	227
Testing of commercial platinum	276
Franzen, Use of hydrosulphite	760
Fresenius, Alkalimeter	376
Determination of carbon dioxide	380
potassium	45
sulphur in sulphides	357
Drying precipitates	21
Electrolysis of nickel solutions	131
Separation of barium, calcium, and strontium	79
and strontium	80
bismuth and copper	198
calcium and magnesium	76
copper and cadmium	202
Solubility of barium chromate	75
strontium carbonate	73
sulphate	73
Volumetric estimation of ferric iron	697

	PAGE
Fresenius, Volumetric estimation of iodides	657
nitrates	634
pyrolusite	625
Friedberger, O., Iodates and periodates	670
Friedheim, Determination of sulphuric acid	714
vanadium	666, 667
Separation of arsenic and antimony	245
vanadic and molybdic acids	666, 667
Friend, J. A., Titration with permanganate	604, 607
Funk, W., Separation of iron and molybdenum	153
G.	
Gaihlott, Determination of nitrous and nitric acids	826
Gay-Lussac, Volumetric estimation of silver	702
Geissler, Alkalimeter	376
Bulb for absorbing gases	416
Gelis, Volumetric estimation of sulphurous acid	692
Gerlinger, Determination of nitrous and nitric acids	826
Gerster, M., Preparation of fuming sulphuric acid mixtures	580
Gibbs, W., Electrolytic determination of copper	187
nickel	131
Determination of magnesium	68
manganese	126
Gilbert, Determination of silica	487
vanadium	304
Gladding, Modification of Kjeldahl's method	63
Gladstone, Density of methane	774
Preparation of ethylene	751
Glaser, Determination of sulphur in sulphides	358
Indicators	548
Göckel, Screen for reading burettes	529
Valve	98, 602
Gooch, F. A., Crucible for asbestos filters	24, 25
Determination of boric acid	428
magnesium	66, 69
manganese	120, 126
phosphoric acid	434
vanadium	304
Separation of aluminium and titanium	116
iodine and chlorine	331
lithium from sodium and potassium	53
Volumetric estimation of copper	682
molybdenum	667, 668
Gott, Direct combustion of steel	413
Goutal, Determination of nickel	720

	PAGE
Grandeau, Determination of nitric acid	456
Gray, Density of nitric oxide	802
Gressly, A., Separation of vanadic and phosphoric acids	307
Griess, Peter, Colorimetric determination of nitrous acid	344
Grimm, Error in measuring instruments	536
Meniscus corrections	744
Gröger, M., Determination of sulphur in sulphides	367
Grossmann, Determination of nickel	720
Grund, R., Magnesite cupels	259
Gutbier, Determination of nitric acid	451
tellurium	279
Separation of tellurium and antimony	281
Guye, P. A., Density of acetylene	754
ethylene	751
nitric oxide	802
Preparation of acetylene	755
H.	
Haber, Absorption of oxygen	759
Combustion of carbon monoxide	766
Computations in gas analysis	782
Determination of benzene	753
ethylene	752, 818
Separation of benzene and ethylene	757
Hackford, E., Electrolytic determination of arsenic	212
Haën, Volumetric estimation of copper	682
Haidlen, Separation of bismuth and copper	198
copper and cadmium	202
Hampe, Determination of copper	185
manganese in steel	619
Separation of antimony, arsenic, and tin	257
antimony and tin	252
arsenic and tin	255
Handy, J. O., Phosphorus in steel	588
Harbeck, Separation of benzene and acetylene	756
Harding, Hydrogen sulphide from insoluble sulphides	368
Hart, Absorption of hydrogen	771
Hauer, Determination of vanadium	304
Heath, Volumetric estimation of copper	682
Heberlein, Determination of sulphocyanic acid	340, 341
Hefti, F., Colorimetric estimation of arsenic	208
Determination of arsenic as arsine	214
Electrolytic determination of arsenic	212
Results obtained in determining arsenic	218
Helmer, Determination of sulphur in iron and steel	364

	PAGE
Hempel, Absorption of oxygen	759
Analysis of illuminating gas	775
Apparatus for gas analysis	743, 785
Combustion of carbon monoxide	766
Detection of carbon monoxide	768
Determination of carbon in iron and steel	404
fluorine as silicon fluoride	829
Rare gases in commercial nitrogen	807
Solubility of acetylene in acetone	754
Technical gas analysis	786
Henry, Non-explosibility of carbon monoxide and nitric oxide mixtures	804
Henz, Determination of antimony	218, 222, 225, 226, 227
boric acid	432
tin	233, 235
Separation of antimony and tin	248
Herold, Analysis of ferrum reductum	612
Hibbert, Volumetric estimation of hydrogen peroxide	700
iron	699
persulphuric acid	701
Hill, A. E., Volumetric estimation of chlorine	707
Hillebrand, W. F., Analysis of silicates	487, 491
Dehydration of silica	493
Determination of chlorine in minerals	324
ferrous iron in silicates	504
iron in silicates	109
sulphur and zirconium	505
titanium	100
uranium	106, 621
vanadium and chromium	310
Precipitation of vanadium	304
Removal of melts from crucibles	488
Testing silicates for barium	495
Hinder, Decomposition of silicates	501
Hinman, Volumetric estimation of sulphuric acid	716
Hinrichsen, Titration of hydrofluosilicic acid	582
Hintz, Determination of sulphuric acid	469
Hofmann, A. W., Separation of copper and cadmium	200
Hoitsema, Determination of silver	706
Hollard, Determination of antimony	225
Holliger, Volumetric estimation of sulphuric acid	716
Holthof, Determination of copper	186
Holverschmidt, Determination of vanadium	304, 306, 666
Hommel, W., Separation of molybdenum and Tungsten	294
Hönig, M., Titration of boric acid	589
Hopkins, Permanence of permanganate solution	90

	PAGE
Huldschinsky, Separation of cobalt and nickel.....	165
Hulett, Apparatus for distilling mercury.....	748
Determination of sulphuric acid.....	465, 469
Hundeshagen, Precipitation of ammonium phosphomolybdate.....	436

I

Ilnsky, Separation of nickel and cobalt.....	165
Ilosvay von Nagy Ilosva, Determination of Acetylene.....	755
Nitrous acid.....	345
Inglis, Determination of ozone.....	677
Inhelder, A., Determination of antimony.....	227
Preparation of sodium sulphide reagent.....	225
Isham, R. M., Determination of titanium.....	118
Isler, Specific gravity of strong acids.....	838, 839

J

Jager, Oxidation of gases.....	797
Janison, Volumetric estimation of copper.....	672
Janini, Determination of zinc.....	146
Jannasch, P., Decomposition of silicates.....	490
Determination of alkalis in silicates.....	501
chlorine in apatite.....	323
water in fluosilicates.....	484
silicates.....	512
Separation of bismuth from lead.....	195
iodine from chlorine.....	332
selenium and tellurium.....	279
Järvinen, K. K., Determination of phosphoric acid.....	434
Jarvis, Volumetric estimation of nickel.....	720
Jawein, Electrolytic determination of cadmium.....	189
Jeffery, J. H., Titration with permanganate.....	604, 607
Johnson, Volumetric estimation of nickel.....	720
Johnston, Determination of phosphorus in iron and steel.....	861
of sulphur in iron and steel.....	366
Jones, Reductor.....	608, 637
Jones, C. C., Titration with permanganate.....	604, 607
Jones, H., Titration of boric acid.....	589
Jones, W. A., Carbon monoxide-copper compound.....	763
Jordis, Dehydration of silicic acid.....	487
Jorgensen, G., Determination of magnesium.....	67
phosphoric acid.....	434
Titration of boric acid.....	589
Jungfleisch, Distribution of iodine between two solvents.....	658

K

Kanter, Dehydration of silicic acid.....	487
Kassner, Titration of barium peroxide.....	628

	PAGE
Keen, W. H., Electric furnace	414
Keller, E., Determination of selenium and tellurium in copper	284
Separation of selenium and tellurium	282
from copper	280, 282
Kempf, R., Titration of persulphates	630
Kerner, Separation of halogens and cyanogen	339
Kessler, Titration with permanganate	604
Kingzett, Determination of hydrogen peroxide	680
Kinnicutt, Oxidation of carbon monoxide	767
Kjeldahl, Method for determining nitrogen	62
Klapproth, Determination of antimony	225
Kling, Determination of potassium	48
Knecht, Volumetric estimation of hydrogen peroxide	700
iron	699
persulphuric acid	701
Knerr, Electrolytic determination of mercury	172
Knop, Determination of ammonia	822
Knorre, Separation of nickel and cobalt	165
Koch, A. A., Determination of fluorine	476, 830
Separation of phosphoric and hydrofluoric acids	474
Kohlrausch, F., Reduction of weights to vacuo	13, 14
Testing of weights	15
Koppeschaar, W., Determination of phenol	695
Korbuly, M., Absorption of benzene	753
Kramers, G. H., Precipitation of zinc sulphide	160
Kraut, K., Determination of nickel	129
Kreider, Preparation of perchloric acid	51
Kreitling, Use of burette floats	529
Krug, Determination of sulphur in iron and steel	365
Küster, Determination of sulphuric acid	467
Sodium hydroxide solution free from alkali carbonates	555
Titration of alkali carbonates	562, 564
Kuzma, B., Separation of selenium and tellurium from metals	280

L

Ladenburg, R., Determination of ozone	677, 680
Lagutt, E., Determination of silver	318
Langbeck, H. W., Ortho-nitrophenol as indicator	543
Leberle, Determination of iron	89
Lecco, Calorimetric determination of iodine	661
Leclenier, Determination of antimony	225
Leduc, Density of carbon dioxide	750
chlorine	808
hydrogen chloride	814
hydrogen sulphide	348, 816

	PAGE
Leduc, Density of sulphur dioxide.....	815
Lefort, J., Aqua regia for dissolving sulphides.....	362
Lenssen, Titration with permanganate.....	604
Volumetric estimation of ferricyanic acid.....	694
Leutold, Combustion of hydrogen.....	773
Levol, Determination of arsenic.....	206
manganese in pyrolusite.....	624
Solubility of magnesium ammonium arsenate.....	208
Levy, Volumetric estimation of copper.....	672
Lieben, Volumetric estimation of formic acid.....	626
Liebig, J., Determination of carbon and hydrogen in organic compounds.....	414
sulphur in organic compounds.....	371
Separation of nickel from cobalt.....	163, 164
Titration of cyanogen.....	711
Liechti, Determination of nitric acid.....	460
Lindemann, Absorption of oxygen by phosphorus.....	759
Lockemann, Determination of arsenic.....	208
Loose, R., Methyl red.....	543
Lösekan, G., Determination of zinc.....	140
Low, A. H., Analysis of copper ores.....	725
Determination of copper by iodide method.....	682
potassium cyanide.....	725
lead.....	727
Löwe, Separation of bismuth and lead.....	195
Löwenthal, J., Precipitation of tin.....	232
Titration with permanganate.....	604
Luckow, Determination of antimony.....	224
zinc.....	147
Electrolytic determination of mercury.....	172
Lunge, G., Analysis of fuming acids.....	579
pyrolusite.....	624
Dehydration of silicic acid.....	487
Determination of carbon dioxide.....	388, 391
nitrous acid.....	345, 626
sulphur in pyrite.....	362
-Rey pipette.....	575
Separation of ethylene and benzene.....	756
Soluble and insoluble silicic acid.....	507
Standardization of permanganate.....	92
Specific gravities of ammonia solutions.....	841
strong acids.....	838
Universal apparatus.....	387, 823
Luther, Analysis of chlorates.....	669
Ozone.....	677
Lux, Analysis of red lead.....	623

M

	PAGE
Manchot, Titration with permanganate.....	695
Marchand, Determination of mercury.....	172
Marchlewski, Determination of carbon dioxide.....	388
Specific gravities of strong acids.....	838, 839
Margosches, B. M., Analysis of iodides.....	671
Margueritte, Volumetric estimation of iron.....	89, 99, 603
Marquardt, Analysis of ferrum reductum.....	612
Marshall, M., Colorimetric determination of manganese.....	128
Martz, E., Oxygen in sea water.....	740
Mascazzini, Determination of antimony.....	224
Massaciù, Determination of chromium.....	103
May, W. C., Drying lead peroxide deposits.....	178
Mayer, L., Determination of lithium.....	56
Purification of mercury.....	747
Mayr, D. K., Determination of antimony.....	227
McArthur, Determination of potassium.....	45, 48
McKay, Determination of arsenic.....	205
Mensel, Volumetric analysis of iodides.....	656
Merck, Determination of metallic iron in the presence of oxide.....	611
Merling, Determination of lithium.....	56
Metzl, Determination of antimony.....	221
Separation of antimony and tin.....	248, 250
Meyer, J., Determination of manganese.....	125
Meyer, V., Nitrous oxide.....	800
Michaelis, Separation of arsenic and antimony.....	245
Millberg, Dehydration of silicic acid.....	487
Separation of soluble and insoluble silicic acid.....	507
Miller, Notes on assaying.....	264
Miolati, A., Electrolytic determination of mercury.....	173
Misteli, W., Preparation of ethylene.....	751
Mitscherlich, Determination of ferrous iron in silicates.....	504
Mittash, Separation of iron and manganese.....	154
Mohr, Definition of liter.....	521
Titration with pyrolusite.....	625
Mohr, C., Volumetric estimation of iron.....	681
ferrieyanic acid.....	694
Mohr, F., Determination of bromine.....	709
chlorine.....	708
Preparation of litmus solution.....	545
Möller, Titration of fluosilicic acid.....	583
Moore, Volumetric determination of nickel.....	720
Moore, C. J., Purification of mercury.....	747
Morse, Permanence of permanganate solutions.....	90
Morton, Volumetric determination of sulphuric acid.....	716

	PAGE
Müller, E., Analysis of iodates and periodates	670
Determination of ferricyanic acid	695
Müller, M., Separation of tellurium and selenium	279
tungsten and tin	301
Müller, W., Use of benzidine hydrochloride	714
Munroe, C. E., Crucible with platinized felt	27
Muthmann, Separation of tellurium and antimony	281
Mylius, Testing commercial platinum	276

N.

Naef, Specific gravities of strong acids	838, 839
Neher, F., Determination of arsenic	205
Separation of arsenic and antimony	243
tin	255
Neubauer, Determination of cyanogen and halogens	339
phosphoric acid	434
Precipitation of potassium	47, 48
Nernst, Molecular volumes	782
Neuman, Electrolytic separation of copper and cadmium	203
Nicloux, Oxidation of carbon monoxide	767
Noyes, W. A., Determination of sulphur in iron and steel	364
Nydegger, Determination of sulphuric acid with benzidine	714

O.

Oberer, Separation of copper and cadmium	010
Oechelhäuser, Determination of ethylene	752
Separation of benzene and ethylene	757
Oettel, Determination of fluorine as silicon fluoride	829
phosphorus in bronze	238
Offerhaus, Determination of chlorine gas by titration	811
Ohm, Law of	133
Oppenheim, C., Absorption of nitric oxide	803
Orsat, Apparatus for gas analysis	797
Osann, Volumetric determination of silver	706
Ost, Determination of antimony	225, 227
Ostwald, Definition of <i>mol</i>	455
<i>solubility product</i>	156
Washing precipitates	18

P.

Palmera, W., Iridium in commercial platinum	275
Panting, Determination of carbon monoxide	762

	PAGE
Parr, Volumetric determination of copper	673
Parrodi, Electrolytic determination of antimony	224
Pattinson, J., Determination of manganese in iron and steel	642
sulphuric acid	467
Paul, Drying oven	33, 34
Heating antimony pentasulphide	220
Pease, Determination of phosphorus in bronze	239
Péchar, Analysis of wolframite	296
Pelouze, Titration of nitrates	634
Penfield, S. L., Determination of fluorine	476
water in silicates	512
Titration of hydrofluosilicic acid	582
Pennock, Volumetric determination of sulphuric acid	716
Penny, Determination of iron by dichromate	641
stannous chloride	697
Perillon, Separation of tungsten and silicon	302
Pettenkofer, Determination of carbon dioxide in air	593
Pettersson, O., Determination of carbonic acid	384
carbon in steel	405
Pfeiffer, Separation of benzene and ethylene	756, 757
Philipp, R., Analysis of tungsten bronzes	298
Determination of sulphocyanic acid	340
Colorimetric determination of cadmium	189
Separation of copper and cadmium	203
Phillips, Condition of sulphur in iron and steel	352
Determination of silicon in presence of silicic acid	513
Philosophoff, P., Analysis of chlorine gas	812
Piloty, O., Separation of arsenic and antimony	245
Pincus, Determination of phosphoric acid	718
Poggiale, Titration of pyrolusite	624
Pollak, L., Explosibility of carbon monoxide—nitric oxide mixtures	804
Permanence of ammoniacal copper solution	756
Solubility of nitrous oxide	801
Potain, Determination of carbon monoxide in air	769
Preusser, Analysis of iron-tungsten alloys	298
Prince, Analysis of iodides	671
Q.	
Quasig, Ozone determination	677
R.	
Rammage, Determination of manganese	616
Rammelsberg, Analysis of wolframite	297
Separation of lithium, sodium and potassium	55

	PAGE
Raschig, Titration of hydroxylamine	631
sulphuric acid by benzidine	714
sulphurous acid	693
Rayleigh, Density of carbon dioxide	386, 750
hydrogen	770
nitrous oxide	800
Recoura, Determination of sulphuric acid	467
Reddrop, Determination of manganese	616
Regnault, Tension of aqueous vapor	842-845
Reich, Determination of nitric acid	453
sulphur dioxide	815
Reinhardt, Titration with permanganate	607, 609
Retgers, K., Determination of manganese	125
Reuter, M., Determination of sulphuric acid	716
Richards, T. W., Precipitation of calcium in presence of magnesium	76
Solubility of calcium oxalate	70
Testing weights	15
Ricketts, Notes on assaying	264
Riegler, E., Standardization of permanganate	599
Riess, Determination of antimony	224
Ritter, Determination of nitric acid	460
Rittener, Determination of carbonic acid	391
Rivot, Analysis of iron ores	88
Determination of copper	186
Separation of copper from cadmium	202
Rohmer, M., Separation of arsenic and antimony	245, 246
Romijn, Titration of formaldehyde	694
hydroxylamine salt	581
Rosanoff, M. A., Determination of chlorine	707
Roscoe, Precipitation of vanadium	304, 305
Rose, H., Determination of ammonium as chloroplatinate	58
bismuth	181
cyanogen	338
ferricyanide	343
sulphur in sulphides	359
water in fluosilicates	484
Precipitation of vanadium	304, 306
Reduction of mercuric salts	171
Separation of antimony and tin	250
, arsenic, and tin	256
barium, calcium, and strontium	79
copper and cadmium	202
molybdenum and tungsten	296
phosphoric and hydrofluoric acids	474
Volumetric estimation of sulphurous acid	692

	PAGE
Rosenblatt, Determination of boric acid	428
Rosenheim, Separation of copper and nickel	165
Rössing, Determination of antimony	222
Separation of antimony and tin	248, 255
Rothe, Solution of ferric chloride in ether	167
Rothmund, Determination of chlorine	708
Ruegenberg, M., Separation of molybdenum and tungsten	293
Rüderff, Electrolytic determination of mercury	172
Rupp, Methyl red	543
Volumetric estimation of sulphurous acid	692
Rutter, Analysis of chlorates	669
S.	
Sahlbom, Titration of hydrofluosilicic acid	582
Sand, H. G. S., Electrolytic determination of arsenic	212
Sanger, C. R., Colorimetric determination of arsenic	208, 210
Särnström, Determination of carbon in steel	399
Schaffgottsche, Precipitation of magnesium ammonium carbonate	69
Scheen, Determination of antimony	227
Schellbach, Burette	529
Schiff, H., Azotometer	423
Schirm, E., Determination of aluminium	85
chromium	103
Schloetter, Examination of electrolytic chlorine	812
Schlösser, W., Correction tables	519, 533
Draining of burettes	528
Error in measuring vessels	536
Meniscus corrections	745
Schlössing, Separation of potassium and sodium	50
Schmidt, E., Analysis of ferrum reductum	612
H., Separation of barium and strontium	81
Schmitz, B., Method of precipitating magnesium	67
phosphoric acid	434
Schneider, Direct combustion of steel	413
Manganese determination	616
Scholler, Determination of chromium	103
Schönbein, Estimation of ozone	676
Schrauth, Determination of chromium	103
Schröder, Separation of tellurium and antimony	281
Schröter, A., Dehydration of silicic acid	487
Schrötter, Alkalimeter	376
Schucht, Titration of hydrofluosilicic acid	583
Schudel, Determination of manganese	120
Schudl, Standardization of permanganate	97
Schulze, Determination of nitric acid	456

	PAGE
Schulze, Titration of pyridine bases	561
Schweitzer, P., Solubility of barium chromate	75
Seeman, L., Precipitation of gold by hydrogen peroxide	258
Separation of gold and platinum	272
Shimer, P. W., Direct combustion of steel	413
Smith, Method for separating zinc from nickel, etc.	158
Smith, E. F., Electrolytic determination of cadmium	190
mercury	172
Separation of molybdenum and tungsten	293
Smith, J. L., Determination of alkalis in silicates	496
Smitt, A., Determination of carbon in steel	405
Snelling, W. O., Use of a Munroe crucible	27
Sonnenschein, Determination of phosphoric acid	436
Sonnstädt, Separation of potassium and sodium	50
Sörensen, Standardization of acids	548
permanganate	597
Soret, Determination of ozone	680
Soxhlet, Fat extraction apparatus	236
Spear, E. B., Electrolytic determination of zinc	146
Spitz, G., Titration of boric acid	589
Spitzer, Determination of zinc	145
Stahrfoss, M., Density of acetylene	754
ethylene	751
Preparation of acetylene	755
Stas, Analysis of commercial platinum	272
Steen, O., Separation of lead and bismuth	197
Steffan, Determination of phosphoric acid	439, 440
Volumetric separation of vanadium and molybdenum	667, 668
Stieglitz, J., Theory of indicators	540
Steinbeck, Determination of copper	725
Steiner, O., Determination of chlorine by titration	811
Stillman, T. B., Analysis of incandescent mantles	512
Stock, A., Determination of aluminium	84
chromium	103
Separation of arsenic and antimony	245
Stoffel, M., Determination of lead	179
Stokes, Absorption of benzene	753
ethylene	752
Determination of carbon monoxide	764
ferrous iron	504
Separation of ethylene and benzene	756
Stromayer, Separation of barium, calcium, and strontium	79
iron and titanium	115
Subech, A., Silicic acid in clay	508
Swett, O. D., Use of Munroe crucible	27

T.

	PAGE
Talbot, H. P., Removal of melt from crucible.....	488
Tamm, H., Determination of manganese.....	121
zinc.....	140
Than, C., Standardization of sodium thiosulphate solution.....	647
Thénard, Ozone.....	680
Thiel, Determination of sulphuric acid.....	467
Thiele, J., Apparatus for chlorine determination.....	813
Determination of arsenic.....	205
antimony.....	223
Thomsen, J., Heats of combustion.....	845
Thomson, W., Electrolytic determination of arsenic.....	212
Thorpe, T. E., Electrolytic determination of arsenic.....	212
Tiemann, Determination of nitric acid.....	456
Tomicek, Determination of arsenic.....	205
Tootmann, S. R., Determination of arsenic.....	212
Topf, Volumetric determination of lead peroxide.....	675
Toth, J., Titration of phenol.....	697
Treadwell, F. P., Absorption of benzene.....	753
ethylene.....	752
Apparatus for chlorine determination.....	808
Collection of gas samples.....	733
Colorimetric determination of arsenic.....	208
Computations in gas analysis.....	782
Density of carbon monoxide.....	764
chlorine.....	808
Determination of carbon monoxide.....	764
ferrous iron in silicates.....	503
hydrofluoric acid.....	476
iron.....	89
nickel.....	137, 138
ozone.....	677
Gases from defibrinated blood.....	740
Separation of ethylene and benzene.....	756
Titration of hydrofluosilicic acid.....	582
Treubert, Determination of bismuth.....	181
Tribe, Density of methane.....	774
Preparation of ethylene.....	751
Tromsdorff, Determination of nitrous acid in water.....	346
Tschugaeff, L., Determination of nickel.....	129
Separation of nickel and cobalt.....	161
manganese.....	165
zinc.....	165

U.

	PAGE
Ukena, Determination of manganese in steel.....	619
Urech, W., Determination of bismuth.....	182

V.

Vanino, L., Determination of bismuth.....	181
Precipitation of gold by hydrogen peroxide.....	258
Separation of gold and platinum.....	272
Van Name, R. G., Determination of copper.....	186
van't Kruys, M. J., Determination of sulphuric acid.....	464
Vernon, R. H., Analysis of fuming acids.....	577
Viogili, J. F., Solubility of manganese ammonium arsenate.....	208
Vogel, Detection of carbon monoxide.....	768
cobalt.....	165
Voigt, Determination of zinc.....	140
Volhard, Analysis of sulphocyanate and halogens.....	342
Determination of manganese as sulphate.....	120
Precipitation of mercuric sulphide.....	168
Standardization of sodium thiosulphate.....	648
Titration of bromine.....	709
chlorine.....	707
cyanogen.....	710
iodine.....	709
manganese.....	612
silver.....	705
sulphurous acid.....	692
sulphocyanide.....	712
with permanganate.....	604
Transformation of chloride into oxide.....	142
von Girssewald, Electrolytic determination of cadmium.....	189
Separation of copper and cadmium.....	202
v. Jüptner, H., Determination of phosphorus.....	436
v. Knorre, Combustion of gases using copper oxide.....	797
nitric oxide.....	803
Determination of manganese in steel.....	620
sulphuric acid.....	714
tungsten.....	290, 291
v. der Pfordten, O., Absorption of oxygen.....	760
Precipitation of mercurous tungstate.....	289
v. Rath, G., Precipitation of mercuric sulphide.....	194
Vortmann, G., Electrolytic determination of mercury.....	172
Determination of antimony.....	221
Removal of sulphur from precipitates.....	169
Separation of antimony and tin.....	248, 250

W.

	PAGE
Wade, Determination of carbon monoxide	762
Wagner, Determination of ammonia in ammonium salts	822
Draining of burettes	528
Indicators	548
Standardization of sodium thiosulphate solution	647
Walker, Permanence of permanganate solutions	90
Wallace, Volumetric estimation of iron	697
Walters, J. H., Jr., Determination of titanium	101
H. E., Colorimetric determination of manganese	128
Warder, R. B., Behavior of sodium bicarbonate solutions toward phenolphthalein	562
Titration of alkali carbonate and bicarbonate	566
carbonate and hydroxide	564
Washburn, E. W., Iodimetric titration of arsenic	650
Weber, H., Determination of sulphuric acid	469
Weber, J., Ignition of calcium sulphate	71
Wegelin, A., Composition of sodium sulphide solution	226
Determination of iron	89
nitric acid	458
Weitnauer, H., Determination of manganese	126
Weller, A., Determination of titanium	100, 504
Titration of antimony	687
Wells, Determination of copper by potassium iodate	672
Wense, Separation of potassium and sodium	50, 51
Wherry, E. T., Determination of boric acid in minerals	590
Whitby, G. S., Solubility of silver chloride	317
Wiernik, Specific gravity of ammonia solutions	841
Wiborgh, J., Determination of carbon in steel	405
sulphur in iron and steel	354
Wilfarth, Modification of Kjeldahl method	63
Will, Alkalimeter	376
Titration of pyrolusite	625
Wilner, Determination of metallic iron in the presence of oxide	611
Windelschmidt, A., Determination of nickel	137, 138
Winkler, C., Absorption of benzene	753
Combustion of hydrogen	772
Detection of carbon monoxide	769
Determination of chlorine by titration	811
Titration of alkali carbonate and bicarbonate	565
hydroxide	563
bicarbonate in the presence of carbonate	592
Use of gauze electrodes	134
Winkler-Dennis, Method of technical gas analysis	794
Winkler, L. W., Absorption coefficient of hydrogen	771

	PAGE
Winkler, L. W., Absorption coefficient of methane	774
nitric oxide	803
nitrogen	807
Determination of absorbed oxygen	760
carbon monoxide	762
Solubility of oxygen	757
Winteler, Determination of mercury	172
Titration of hydrofluoric acid	581
Wohl, A., Computations in gas analysis	782
Wöhler, Determination of carbon in steel	406
Tungsten bronzes	298
Wolff, O., Determination of antimony	227
Wolfrum, L., Analysis of ferrum reductum	612
Wolter, L., Determination of tungsten in steel	292
Woy, Determination of phosphorus	436
as phosphomolybdic anhydride	440
Method of precipitating ammonium phosphomolybdate	437
Wynkoop, G., Determination of aluminium	85

Y.

Young, S. W., Standardization of iodine solution	651
--	-----

Z.

Zawadzki, Precipitation of sulphides	158
Zimmermann, Determination of uranium	106
Precipitation of zinc as sulphide	158
Reduction of ferric salts	609
Titration with permanganate	604, 605, 609
Volumetric determination of uranium	621



INDEX OF SUBJECTS.

A.

Acceptor, definition of	605
Acetic acid,	371, 583
anhydride	583
Acetylene	754
determination in presence of ethylene	821
preparation of	755
Acidimetry	537, 571
Acids, specific gravities of	858, 859
volumetric determination of	571, 575, 583
Adsorption	18
Air bath	27, 32
Air, determination of carbon dioxide in	397, 593
Alkali bicarbonates, volumetric determination of	564
in presence of carbonates	565
Alkali carbonates, volumetric determination of	562
in presence of bicarbonates	565
hydroxides	563
Alkalies	38
determination in lepidolite	502
silicates	496, 499
separation from metals of Group III	107, 147
molybdenum	286
(caustic), specific gravities of	860, 861
volumetric determination of	558
Alkali hydroxides, volumetric determination of	558
in presence of carbonates	563
Alkalimeter	376
Alkalimetry	537, 558
Alkaline earths	70
separation from the alkalies, and magnesium	78
metals of Group III	107, 147
molybdenum	287
one another	79
Alkaline earth bicarbonates, volumetric determination of	568
carbonates, volumetric determination of	566, 567

	PAGE
Alkaline earth hydroxides.	566
salts, titration of.	570
Alkali sulphides, analysis of.	689
and hydrogen sulphide.	691
sulphydrates, titration of.	689
Aluminium.	82
determination in bronzes.	236
silicates.	492
separation from alkalis and alkaline earths.	107
chromium.	114
iron.	107
iron and phosphoric acid.	111
manganese, nickel, cobalt and zinc.	149, 152
metals of Group II.	192, 235
titanium.	116
uranium.	119
Ammonia (reagent), necessity for redistilling.	82
preparation free from carbonate.	149
specific gravity of.	861
titration of.	560
Ammonium.	57
colorimetric determination.	60
gas-volumetric determination.	822
in drinking water.	60
volumetric determination.	560
Ammonium molybdate, preparation of the reagent.	437, 638
Analysis.	1
direct.	2
gravimetric.	1, 38
indirect.	2
volumetric.	2
Anions, gravimetric determination of.	320
calculation of.	737
Antimony.	218
determination in bearing metal.	252
electrolytic determination.	224
removal from electrodes.	227
separation from arsenic.	241
arsenic and tin.	256
mercury, lead, etc.	235
metals of Group III.	235
selenium and tellurium.	281
tin.	248
volumetric determination.	685, 687
Apparent iron value of wire for standardization,	98, 601

INDEX OF SUBJECTS.

919

	PAGE
Arsenic	205
colorimetric determination	208
determination as arsine	214
in commercial sulphuric acid	248
mispickel	218
vanadinite	309
electrolytic determination	212
separation from antimony	241
antimony and tin	256
mercury, lead, etc	235
metals of Group III	235
molybdenum	287
selenium and tellurium	281
tin	255
Asbestos filters	26
Assay for gold and silver	259
Assay ton	268
Atomic weight table	869
Azotometer	423

B.

Balance, accuracy of	6
sensitiveness of	7
Baking powders, determination of carbonic acid in	377
Barium	74
detection in calcium precipitates	495
determination in silicates and rocks	496, 507
separation from calcium and strontium	79
magnesium	79
strontium	80
metals of Group III	107, 147
metals of Group II	192
volumetric determination	566
Barium carbonate method	149
hydroxide, normal solution of	557
Basic acetate method	152
Bearing metal, analysis of	252
Benzene, determination in gas mixtures	752
separation from ethylene	756
Benzidine hydrochloride, reagent	291, 714, 715
Bicarbonates, in presence of carbonates	592
volumetric estimation of	591
Bichromate, determination of chromium in	105
Bismarck brown	344
Bismuth	179

	PAGE
Bismuth, determination in bearing metal	252
separation from arsenic, antimony, and tin	235
copper and cadmium	198
lead	195
mercury	194
metals of Groups III, IV, and V	192
molybdenum	287
selenium and tellurium	280
Bitter-almond water	337
Blick, the	261
Blood, gases from defibrinated	740
Boric acid	428
in mineral waters	431
silicates and enamels	431
volumetric determination of	588
Brass, analysis of	193
Bromine, determination in mineral waters	660
non-electrolytes	325, 329
soluble bromides	659
gravimetric determination of	329
separation from chlorine	334
chlorine and iodine	336
iodine	335
volumetric determination	655, 660, 709
Bronzes, analysis of	236
Burettes	514
allowable error in	530
calibration of	527
draining of	527
floats for	528
reading of	528

C.

Cadmium	189
colorimetric determination	189
electrolytic determination	189
precipitation as sulphide	191
separation from arsenic, antimony, and tin	235
copper	200-204
lead	200
mercury	194
metals of Groups III, IV, and V	192
molybdenum	287
selenium and tellurium	280

	PAGE
Calcium	70
determination in silicates	494
separation from barium and strontium	79
magnesium	76
metals of Group III	107, 147
metals of Group II	192
volumetric estimation	566, 623
chloride, presence of free lime in	377
precipitates, testing for barium in	495
Calibrated flasks, testing of	524
Calibration of burettes	527
gas-measuring instruments	743
flasks	522
pipettes	524
Carbon, determination in iron and steel	398
nitrogenous organic substances	419
organic substances	414
dioxide (<i>see</i> Carbonic acid), determination of	750, 778, 788
in electrolytic chlorine	808
Carbonates, in presence of bicarbonate	592
volumetric estimation of	591
Carbonic acid	375
combined, calculation of	736
determination in air	397, 593
baking powders	377
carbonates	591
chlorine	397, 808
illuminating gas	778, 788
mineral waters	382, 736
presence of bicarbonate	591
cyanic and hydrocyanic acids	371
N ₂ O, NO, and N	806
free, calculation of	738
determination of	590
Carbon monoxide, determination of	762, 779, 781, 789
qualitative detection in air	768
Cathodes, cleaning of	136, 227
Cations, calculation of those present in water	737
gravimetric determination of	38
Ceric oxide, iodimetric titration of	665
Cement, Analysis of	864
Cerium, determination in soluble salts	828
Charcoal, testing the reducing power of	265
Chemical factors, table of	870
Chlorates, analysis of	460, 633, 669
Chloric acid, gravimetric determination	460

	PAGE
Chloric acid, in the presence of perchloric acid	463
and hydrochloric acids	463
reduction of	461
volumetric determination of	633, 669
Chlorine, free, determination by titration	809
gravimetric determination	324
volumetric determination	654
gravimetric determination	320
in aqueous solutions	320
commercial tin chloride	321
insoluble chlorides	323
organic substances	325
vanadinite	308
separation from bromine	334
carbon dioxide	397
chlorate and perchlorate	463
cyanogen	339, 711
fluorine	482
iodine	331, 335
iodine and bromine	336
volumetric determination	654, 707, 708
Chlorine gas, examination of	808
Chloroplatinates, conversion of chlorides into	43
Chromates, gravimetric analysis of	105
volumetric analysis of	641, 649, 664, 675
Chromic acid. <i>See</i> chromates.	
compounds	102
Chromite, analysis of	509
determination of chromium in	675
Chromium	102
determination in iron ores and rocks	310
chromite	510, 675
pig iron	312
steel	313, 854, 856
separation from alkaline earths and magnesium	107
aluminium	114
iron	113
nickel, cobalt, manganese and zinc	149
volumetric determination of	664, 675
Clay, soluble silicic acid in	508
Closet, drying	24, 25
Cobalt	138
determination in arsenical sulphide ores	842
electrolytic determination	138
separation from alkaline earths and magnesium	147

	PAGE
Cobalt separation from manganese	161
metals of Group III	149, 152
metals of Group II	192
nickel	161-164
zinc	156
Coil for heating crucibles by steam	32
Collection and confinement of gases	730
Columbium, <i>see</i> Niobium.	
Combustion (elementary analysis)	414
of organic substances containing halogen	421
metal	422
sulphur	422
furnace	415
tube	416
of gases	764
(a) by explosion	765
(b) method of Dreschmidt	766
(c) by method of Winkler-Dennis	794
(d) fractional	766
Cone for holding crucible on water bath	31
Copper	182
analysis of for selenium and tellurium	284
determination in bearing metal	252
brass	193
bronze	236
ores	673, 683, 725
electrolytic determination	187
separation from arsenic, antimony and tin	235
bismuth	198
cadmium	200
lead	198
mercury	194
metals of Groups III, IV and V	192
volumetric determination	672, 682, 725
Crucible, Gooch	24, 25
Crystals, size of	36
Cupellation	259
Cupferron, preparation of	840
use in quantitative analysis	838
Cyanic acid	371
in the presence of carbonic and hydrocyanic acids	371
Cyanogen	337
in the presence of halogens	339, 711
sulphocyanogen	342, 712
chlorine and sulphocyanogen	713
volumetric determination	710

D.

	PAGE
Defibrinated blood, gases from.....	740
Desiccator.....	23
Dichromate methods.....	641
Dimethyl glyoxime, reagent.....	129
Direct methods of analysis.....	2
Distribution coefficient.....	658
Double weighing.....	9
Drying apparatus.....	416
closet.....	24, 25, 33
of precipitates.....	21
of substances in currents of gases.....	33, 220
ovens.....	21, 24, 25, 28, 33, 34

E.

Electric furnace.....	28
Electrodes.....	93, 134
cleaning of.....	136, 227
Electrolytic determination of antimony.....	224
arsenic.....	212
cadmium.....	189
cobalt.....	138
copper.....	187
lead.....	177
mercury.....	172
nickel.....	131
tin.....	234
zinc.....	145
iron, for standardizing permanganate solution.....	600
preparation of.....	93
outfit,.....	132, 178
Elementary analysis.....	414
Ethylene, determination of.....	751, 818
separation from acetylene.....	821
benzene.....	757, 820
Evaporation of liquids.....	30
Explosion pipette.....	765

F

Factors, table of chemical.....	870
Fahlerz, analysis of.....	359
Ferric chloride, solution in ether.....	167
iron, volumetric determination of.....	99, 681, 697, 699
Ferric salts, reduction of solutions of.....	607
by hydrogen sulphide.....	99, 112
metals.....	608

	PAGE
Ferric Salts, reduction by stannous chloride	609
sulphurous acid	607
Ferricyanic acid, gravimetric estimation of	344
volumetric estimation of	633, 694
Ferrocyanic acid, gravimetric estimation	342
volumetric estimation	632
Ferrous iron, volumetric determination of	89, 603, 607, 641
Ferrum reductum, analysis of	611, 612
Filters	18
of asbestos	26
size of	20
Filtration and washing precipitates	18
Flasks, calibrated, permissible error in	524
calibration of	522
Floats for burettes	528
Fluorine, determination as calcium fluoride	471
hydrofluosilic acid	476
silicon fluoride	475, 829
in calcium fluoride	472
lepidolite	502
mineral waters	480
presence of phosphoric acid	474
separation from acids	482
metals	481
Formaldehyde (formalin) volumetric determination of	694
Formic acid, volumetric determination of	626
Fractional combustion of gases	766
Fuming acid, analysis of	575
Fuming sulphuric acid	577
Furnace, electric	28

G.

Gas analysis	729
exact	775
technical	786
Gas-combustion pipette	792, 794
Gases, collection and confinement of	730
transference of	742
Gas measuring instruments, calibration of	743
pipettes	786
Gas-volumetric methods	822
Gauze platinum electrodes	134
Generator gas, analysis of	775, 783
Gold, determination in solutions	257
ores	263
precipitation by hydrogen peroxide	258

	PAGE
Gold, separation from platinum.....	271
selenium and tellurium.....	282
silver.....	262
Gram-equivalent, definition of.....	530
Graphite in cast iron.....	414
Gravimetric analysis, methods of.....	2, 38
Grinding, effect on composition.....	837
H.	
Halogens, determination by indirect analysis.....	334
gravimetric determination in presence of cyanide.....	339
separation from cyanide and sulphocyanide.....	342
hydrofluoric acid.....	482
one another.....	331
Hardness of water.....	568, 569
Hematite, determination of iron in.....	610, 698
Heats of combustion of gases.....	845
Hood.....	30, 31
Hydriodic acid.....	330
separation from hydrobromic and hydrochloric acids, 331, 336	
hydrocyanic acid.....	339
volumetric determination.....	709
Hydrobromic acid.....	329
determination in mineral waters.....	660
separation from hydrochloric acid.....	334
and hydriodic acids... ..	336
hydrocyanic acid.....	339
hydriodic acid.....	335
volumetric estimation.....	655, 659
Hydrocarbons, heavy.....	751, 779, 788
separation of.....	756
Hydrochloric acid.....	320
gas, determination of.....	814
normal solution of.....	549
separation from chloric and perchloric acid.....	463
hydriodic acid.....	335
hydrobromic acid.....	334
hydrogen sulphide.....	329
hydrocyanic acid.....	339, 711
and sulphocyanic acids .	713
sulphocyanic acid.....	342, 713
volumetric determination.....	571, 707, 708
Hydrocyanic acid.....	337
determination in bitter almond water.....	337
separation from cyanic and carbonic acids.....	371
halogen hydride.....	339, 711

	PAGE
Hydrocyanic acid separation from hydrochloric and sulphocyanic acids..	713
sulphocyanic acid.....	342, 712
volumetric determination of.....	710, 711
Hydroferricyanic acid.....	344, 633, 694
Hydroferrocyanic acid.....	342, 632
Hydrofluoric acid.....	471
determination as calcium fluoride.....	471
hydrofluosilic acid.....	476
silicon fluoride.....	475, 829
in calcium fluoride.....	472
lepidolite.....	502
mineral waters.....	480
separation from boric acid.....	483
hydrochloric acid.....	482
metals.....	481
phosphoric acid.....	474
volumetric determination.....	581
Hydrofluosilic acid.....	483
analysis of its salts.....	484
determination as calcium fluoride.....	483
potassium silicofluoride.....	484
volumetric determination.....	581
Hydrogen.....	770
determination in nitrogenous organic substances.....	419
organic substances.....	414
Hydrogen peroxide, iodimetric titration.....	680
methods.....	826
titration by permanganate.....	626
titanous chloride.....	700
sulphide, colorimetric determination.....	354
expulsion from insoluble sulphides.....	367
evolution and absorption.....	350
determination in mineral waters.....	349, 688
gas mixtures.....	816
gravimetric determination.....	347
titration of.....	687
separation from alkali sulphhydrate.....	691
thiosulphate.....	691
Hydrosulphite of sodium.....	760
Hydrosulphuric acid (<i>see</i> Hydrogen sulphide).....	347
Hydroxylamine.....	581, 631
Hypochlorous acid.....	344, 669, 701
determination in the presence of chlorine.....	655
Hypophosphorous acid.....	372
separation from phosphorous acid.....	374

	PAGE
Igniting precipitates, method of	21, 28
Illuminating gas, analysis of	775, 786
Incandescent mantles, analysis of	512
Indicators	538
Indirect analysis	2, 56
determination of halogens by	334
SO ₃ content of fuming sulphuric acid	579
error in	6
Inquartation	259
International atomic weights	849
Iodic acid	433
determination in the presence of periodates	670
Iodides, analysis of (<i>see</i> Iodine)	671
Iodimetry	644
Iodine, determination by gravimetric methods	330
in mineral waters	660
non-electrolytes	328
soluble iodides	656
free, titration of	654
preparation of pure	646
separation from bromine	335
bromine and chlorine	336
chlorine	331
solution, standardization of	649
volumetric determination	654, 709
Iodo-starch reaction, sensitiveness of	652
Iron	87
electrolytic	93, 603
determination in bearing metal	252
brass	193
ferrum reductum	611
hematite	610, 698
presence of oxide	611
silicates	493, 502
separation from alkaline earths and magnesium	107
aluminium	107
and phosphoric acid	111
chromium	113
manganese	153
nickel, cobalt and zinc	149, 152, 155
nickel	166
metals of Group II	192
titanium	114
uranium	119

	PAGE
Iron, volumetric determination by permanganate dichromate method....	641
iodimetric method	681
permanganate	603, 607
stannous chloride	697
titanous chloride	699
ore, determination of vanadium in	310
and chromium in	312
wire, determination of apparent iron value	98, 601

L.

Lacmoid	544
Lead	174
determination in bearing metal	252
brass	193
bronze	236
vanadinite	308
electrolytic determination as peroxide	177
separation from arsenic, antimony, and tin	235
bismuth	195
cadmium	200
copper	198
mercury	194
metals of Groups II, IV, and V	192
molybdenum	287
peroxide, analysis of	675
sulphate, separation from barium sulphate and silica	176
volumetric determination by molybdate	727
Lepidolite, analysis of	502
Lime method for halogens in organic substances	329
Liquids, evaporation of	30
Liter, definition of	516, 521
Litharge, testing of	264
Lithium	53
determination in lepidolite	502
indirect determination of	56
separation from sodium and potassium	53
Litmus	544
Logarithms, tables of	874, 875

M.

Magnesia mixture, preparation of	206
Magnesium	65
determination in silicates	495
separation from alkalies	68
barium	79

	PAGE
Magnesium, separation from calcium	76
metals of Group II	192
Group III	107, 147
strontium	78
Manganese	120
colorimetric determination	127
determination by removal of iron with cupferron	841
in bronze	237
ferro-manganese	842
iron and steel:	
by bismuthate method	616
Volhard's method	615
v. Knorre's method	620
Pattinson's method	642
Williams' method	619
manganese ores	841
pyrolusite	624, 663
separation from alkaline earths and magnesium	147
iron	153
metals of Group II	192
nickel and cobalt	161
trivalent metals	149, 155
zinc	156
volumetric determination	612, 616, 619, 620, 663
Measuring flasks	515
calibrating	522
instruments	514
for gas analysis	743
Melt, removal from the crucible	488
Meniscus corrections	745
Mercury	168
determination in organic substances	170
electrolytic determination	172
purification of	747
separation from arsenic, antimony and tin	235
lead, bismuth, copper, and cadmium	194
metals of Groups II, IV, and V	192
selenium and tellurium	281
Metallic iron, determination in presence of oxide	611
Metalloids, gravimetric determination of	320
Metaphosphoric acid	433
Methane	774
determination in gas mixtures	780, 781, 790
separation from hydrogen	790
carbon monoxide and hydrogen	781
Methods, gravimetric	2

	PAGE
Methods, volumetric.....	514
Methyl orange.....	539
Methyl red.....	543
Minium (red lead), volumetric determination of.....	623, 675
Mispickel, determination of arsenic in.....	218
Mole, definition of.....	455
Molybdenum.....	284, 666
determination in steel.....	313
residues, recovery of molybdenum from.....	447
separation from the alkalies.....	286
the alkaline earths.....	287
the metals of Groups II and III.....	287
phosphoric acid.....	288
tungsten.....	293
vanadium.....	308, 667
Molybdic acid, gravimetric determination.....	284
volumetric determination.....	666
Moment, statical.....	8
Monazite, determination of thorium in.....	510
Munroe crucible.....	27

N

Nickel.....	129
determination in arsenical sulphide ores.....	842
brass.....	193
steel.....	166, 313, 723
electrolytic determination.....	131, 136
separation from alkaline earths and magnesium.....	147
cobalt.....	161, 162, 163, 164
iron.....	166
, aluminium, titanium, and uranium.....	149
, aluminium, chromium, titanium, and uranium.....	149
manganese.....	161, 165
zinc.....	156, 165
volumetric determination.....	721
Nickel-chromium alloy for crucible triangles.....	29
Niobium, determination in wolframite.....	297
Nitre, testing the oxidizing power of.....	266
Nitric acid.....	451
determination as ammonia.....	453
nitric oxide.....	456, 825
nitrogen pentoxide.....	453
nitron nitrate.....	451
in drinking water.....	460

	PAGE
Nitric acid, normal solution of	552
volumetric determination	571, 634
Nitric oxide	802
separation from nitrous oxide	804
and nitrogen	805
nitrogen, and carbon dioxide	806
Nitron	451
Nitrous acid, colorimetric determination	344
determination as nitric oxide	825
volumetric determination	626
oxide	800
determination in the presence of nitric oxide	804
and nitrogen	805
nitrogen, and	
carbon dioxide	806
Nitrogen, determination by Dumas method	422
Kjeldahl method	62
in organic substances	422
properties and method of preparation	806
separation from nitrous and nitric oxides	805
oxide and carbon dioxide	806
Nitrophenol as indicator	543
Normal solutions	530, 548
of barium hydroxide	557
hydrochloric acid	549
nitric and sulphuric acids	552
oxalic acid	552
sodium hydroxide	553
preparation of	532
standardization in acidimetry and alkalimetry	548
volume and temperature	516

O.

Oil, removal from borings	236
Oleum, analysis of	575
Operations	6
Organic acids, titration of	583
substances, determination of carbon in	414, 419
chlorine in	325, 329
hydrogen in	414, 419
nitrogen in	62, 422
sulphur in	370
Orthoclase, analysis of	491
Orthophosphoric acid	434
volumetric estimation of	718

	PAGE
Oven for drying	24, 25, 28, 33, 34, 220
Oxalic acid	427
normal solution of	552
volumetric determination of	622
Oxidation methods	596
Oxygen	757
determination in illuminating gas	779, 789
presence of hydrogen in	417
Ozone, determination of	676

P.

Partition, law of (<i>see</i> law of distribution).	
Paul's drying oven	33, 34
Percarbonates, analysis of	628
Perchloric acid	462
determination in the presence of chloric acid	463
hydrochloric acid	463
preparation of	51
Perhydrol	230
Periodic acid (and periodates)	670
Permanence of ammoniacal copper solution	756
permanganate solutions	90, 603
sodium thiosulphate solution	649
oxalic acid solutions	599
Permanganate methods	596
solution, permanence of	90, 603
preparation of	596
standardization of	91, 597, 827
uses of	603
Peroxides, analysis of	627, 680, 661
Persulphuric acid (and persulphates), analysis by permanganate	629
potassium hydroxide	595
titanous chloride	701
Phenol, volumetric estimation of	695
Phenolphthalein	545, 554
Phosphoric acid	434
determination in calcium phosphate	720
mineral water	447
silicates	447
vanadinite	309
separation from alkaline earths and alkalis	449
chromic acid	499
iron and aluminium	111
metals of Groups I, II, and III	448
vanadium	307

	PAGE
Phosphoric acid, volumetric determination	587, 588, 718
Phosphorous acid	374
determination in the presence of hypophosphorous acid.	374
Phosphorus, determination in bronze	238, 239
iron and steel	440, 443, 445, 588, 637, 861
organic substances	448
Pipettes	514
calibration of	524
permissible error in	526
Platinum	268
action of ferric chloride on	110
analysis of commercial platinum	272
brass cone lined with	31
capillary for use in gas analysis	743, 766
determination in alloys	270
separation from gold and silver	270, 271
Portland Cement, Analysis of	864
Potassium	38
determination in mineral water	50
indirect determination	56
separation from lithium	53
sodium	43, 49, 50
Potassium bichromate, determination of chromium in	105
potassium in	40, 41
biiodate solution	647
dichromate solution	532, 641, 649
percarbonate, analysis of	628
permanganate solution	90, 531, 597, 827
persulphate, analysis of	629
Precipitates, drying and igniting of	21
filtration and washing of	18
method of igniting when wet	28
Precipitation analyses, (volumetric)	702
Preparation of the substance for analysis	35
Primary oxides	605
Producer gas, analysis of	775, 783, 784
Protoxides, separation from the sesquioxides	149
Prussian blue, analysis of	343
Prussic acid (<i>see</i> Hydrocyanic acid).	
Pyridine bases, titration of	561
Pyrite, analysis by sodium peroxide method	848
determination of sulphur in	362
Pyrogallol solution, preparation of	758
Pyrolusite, analysis of	624, 663
Q.	
Quartation	259

R.

	PAGE
Recrystallization	35
Red lead (minium), analysis of	623, 676
Reduction methods of volumetric analysis.	697
of ferric salts	607
weighings to vacuo	13
Resorcin blue as indicator	544
Rutile, determination of titanium in	118

S.

Salting out method for precipitating zinc	160
Selenium	277, 374
determination in crude copper	284
separation from gold and silver	282
metals of Groups II, III, IV, and V	280, 281
tellurium	279, 282
Selenous acid	277, 374
Sensitiveness, or sensibility, of the balance	7
Sesquioxides of Group III	82
separation from the protoxides	149
Silica, separation from tungsten	302
testing the purity of	487
triangles for platinum crucibles	29
Silicates, analysis of	491
decomposable by acids	485
determination of alkalis in	496
ferrous iron in	502
water in	484, 512
not decomposable by acids	491
Silicon, determination in iron and steel	441, 442
the presence of silica	513
Silver	317
determination in alloys	259, 706
ores (<i>see</i> Gold)	268
separation from other metals	318
selenium and tellurium	282
volumetric determination	702, 705
Silver chloride, solubility of	317
Sodium	43
determination in silicates	496
indirect determination of	56
separation from lithium	53
potassium	43-50

	PAGE
Sodium hydroxide, determination in commercial caustic soda	558
caustic soda solution	558
normal solution of	553
preparation of a solution free from carbonates	555
sulphide, reagent, preparation of	225
succinate method of separation	155
thiosulphate solution, normal solution of	645
permanence of	649
Solubility product, definition of	156
Solution of sulphides, explanation of the process	157
Specific gravity tables of acid and alkali	858-861
Stannic chloride, analysis of	321, 573
Starch solution	652
Statical moment of a balance	8
Steel, determination of carbon in	398
chromium in	854, 856
manganese in	615, 616, 619, 620, 642
nickel	166, 723
nickel, manganese, chromium, and vanadium	313
phosphorus	440, 443, 445, 588, 637, 861
sulphur in	850
Stibnite, determination of antimony in	686
Streak of gold alloys	261
Strontium	72
separation from barium	80
calcium	79
magnesium	78
metals of Group II	192
metals of Group III	107, 147
Substitution, weighing by	9
Sulpho-acids	205
separation from one another	241
Sulpho-bases	168
separation from one another	194
Sulphides, determination in the presence of sulphates	470
theory of their solubility in acid	157
titration of	689
Sulphocyanic acid	339, 712
separation from halogen hydrides	342
hydrocyanic and hydrochloric acids	713
Sulphydrates, analysis of	689, 691
Sulphur, colorimetric determination	354
determination in insoluble sulphides	357, 367, 368
iron and steel	352, 354, 364, 365
mineral waters	688

4 methods of analysis - - - - - 347

	PAGE
Sulphur, determination in organic substances	370
pyrite	357, 362, 716
by sodium peroxide method	848
rocks	505
steel by a volumetric method	850
sulphides soluble in acids	350
water	349
dioxide, gravimetric determination	373
volumetric determination	587, 692, 815
removal from precipitated sulphides	169, 180, 223
volumetric determination in gas mixtures	687, 816
Sulphuretted hydrogen (<i>see</i> Hydrogen sulphide and Sulphur).	
Sulphuric acid	464
determination of arsenic in	248
in the presence of soluble sulphides	470
preparation of concentrated acid of definite strength	580
normal solution of	551
volumetric determination of	571, 577, 714, 716
Sulphurous acid (<i>see</i> Sulphur dioxide)	373
volumetric determination	587, 692
Swings, weighing by the method of	10

T.

Tables *	517, 519, 520, 522, 533, 534, 535, 869-891
Tantalum, determination of wolframite	297
Tare	9
Tartar emetic, analysis of	685
Tartaric acid	433
Teclu burner	94
Telluric acid (<i>see</i> Tellurium)	664
Tellurium, determination in crude copper	284
precipitation with sulphurous acid	279
separation from antimony, tin, and arsenic	281
copper, bismuth, and cadmium	280
gold and silver	282
mercury	281
metals of Group II	280
Groups III, IV, and V	279
selenium	282
volumetric estimation	664
Tellurous acid (<i>see</i> Tellurium)	374
Temperature, taken as normal in volumetric work	516

* The tables in this book can be purchased separately in flexible cloth binding. Price, thirty-five cents.

	PAGE
Testing of weights	15
Tetrahedrite, analysis of	359
Thallium, determination of	318
Thiocyanic acid (<i>see</i> Sulphocyanic acid),	
Thiosulphuric acid (thiosulphate)	450, 645
determination in presence of sulphide	691
Thorium, determination in monazite	510
Tin	228
determination in bearing metal	252
bronze	236
tin chloride	321, 573
separation from alkaline earths and magnesium	235
antimony	248, 256
arsenic	255
mercury, lead, bismuth, copper, and cadmium	235
metals of Group III	235
phosphoric acid	238, 239
silicic acid	298
tungsten	297, 300
Titanium	100
Titanium, colorimetric determination	100
determination in rocks	504
rutile and iron ores	118
titanium-iron ore	844
separation from alkaline earths	107
aluminium	116
iron	114
iron, aluminium and phosphoric acid	843
manganese, nickel, cobalt and zinc	149, 152
Titanous chloride, as reagent in volumetric analysis	700
Total carbon in iron and steel	399
Tungsten	288
determination in ores	858
steel	291
wolframite	296
separation from molybdenum	293
silica	302
tin	297, 300
Tungsten bronzes, analysis of	298
U	
Uranium	106
separation from alkaline earths and magnesium	107
aluminium and iron	119
metals of Group II	192, 235
nickel, cobalt, manganese and zinc	149
volumetric determination	621

V.

	PAGE
Vacuo, reduction of weighings to.....	13
Valve, Bunsen.....	87, 98, 601
Contat-Göckel.....	304, 602
Vanadic acid (<i>see</i> Vanadium).	
Vanadium.....	303
determination in ores and rocks.....	310
pig iron.....	312
steel.....	313
vanadinite.....	309
separation from arsenic.....	306
molybdenum.....	308, 313, 667
phosphoric acid.....	307
volumetric determination.....	636, 665
Vanadinite, analysis of.....	308
Vapors, determination in gases.....	831
Volume, normal.....	516
Volumetric analysis.....	1, 514

W.

Water bath.....	31
Water, density at different temperatures.....	517
determination of absorbed oxygen in.....	760
in fluosilicates.....	484
lepidolite.....	502
silicates.....	512
hardness of.....	569, 570
vapor, tension of.....	862
Washing precipitates.....	18
Weighing.....	6
double.....	9
by substitution.....	9
swings.....	10
reduction to vacuo.....	13
Weights, testing of.....	15
Wet precipitates, method of igniting.....	28
Welsbach mantles, analysis of.....	512
White lead, analysis of.....	379
wolframite (Wolfram) analysis of.....	296

Z.

Zinc.....	140
determination in bearing metal.....	252
brass.....	193
bronze.....	237

	PAGE
Zinc, electrolytic determination	145
separation from alkaline earths and magnesium	147
metals of Group II	192, 235
nickel cobalt, and manganese	156
trivalent metals of Group III	149-155
Zirconium, determination in rocks	505

WORKS TRANSLATED BY
WILLIAM T. HALL

PUBLISHED BY
JOHN WILEY & SONS, Inc.

F. P. TREADWELL'S ANALYTICAL CHEMISTRY.

IN TWO VOLUMES

Vol. I. Qualitative Analysis.

xiii+538 pages, 6×9. Cloth,

Vol. II. Quantitative Analysis.

xi+926 pages, 6×9, 126 figures. Cloth,

(With G. W. ROLFE.)

H. Classen's Beet-Sugar Manufacture.

xiv+287 pages, 6×9. Cloth

(With A. A. BLANCHARD.)

H. and W. Biltz's Laboratory Methods of Inorganic Chemistry.

xv+258 pages, 6×9, 26 figures. Cloth,

(With J. W. PHELAN.)

H. Biltz's Introduction to Experimental Inorganic Chemistry.

vi+185 pages, 5×7½. Cloth,

(With GEORGE DEFREN.)

Emil Aberhalden's Text-book of Physiological Chemistry.

xiii+722 pages, 6×9. Cloth,

(With R. S. WILLIAMS.)

W. Ostwald's Introduction to Chemistry.

v+368 pages 5¼×8, 74 figures. Cloth,

(With C. R. HAYWARD.)

A. Classen's Quantitative Analysis by Electrolysis.

x+308 pages, 6×9, 52 figures. Cloth,

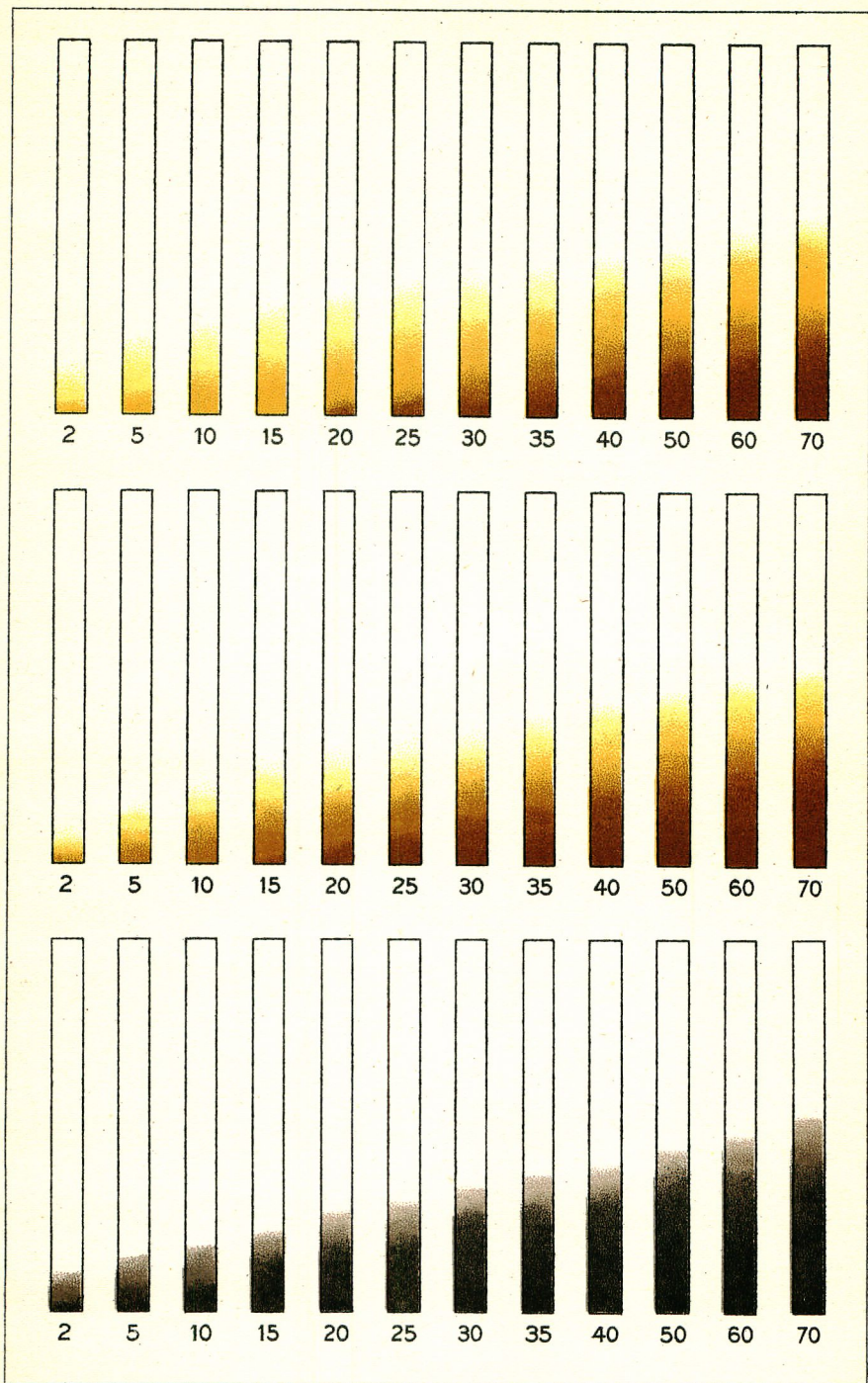

ARSENIC STANDARDS. See pages 211 and 212.