

Fabricators' and Erectors' Guide to Welded Steel Construction

The James F. Lincoln Arc Welding Foundation



Fabricators' and Erectors' Guide to Welded Steel Construction

By **Omer W. Blodgett, P.E., Sc.D.**
R. Scott Funderburk
Duane K. Miller, P.E., Sc.D.
Marie Quintana, P.E.

This information has been provided by
The James F. Lincoln Arc Welding Foundation
to assist the general welding industry.



The serviceability of a product or structure utilizing the type of information presented herein is, and must be, the sole responsibility of the builder/user. Many variables beyond the control of The James F. Lincoln Arc Welding Foundation or The Lincoln Electric Company affect the results obtained in applying this type of information. These variables include, but are not limited to, welding procedure, plate chemistry and temperature, weldment design, fabrication methods, and service requirements.

This guide makes extensive reference to the AWS D1.1 Structural Welding Code-Steel, but it is not intended to be a comprehensive review of all code requirements, nor is it intended to be a substitution for the D1.1 code. Users of this guide are encouraged to obtain a copy of the latest edition of the D1.1 code from the American Welding Society, 550 N.W. LeJeune Road, Miami, Florida 33126, (800) 443-9353.

Fabricators' and Erectors' Guide to Welded Steel Construction

Table of Contents

1	Introduction	1
2	Welding Processes	1
2.1	SMAW	1
2.2	FCAW	3
2.3	SAW	6
2.4	GMAW	8
2.5	ESW/EGW	10
3	Welding Process Selection	11
3.1	Joint Requirements	11
3.2	Process Capabilities	12
3.3	Special Situations	12
4	Welding Cost Analysis	14
5	Welding Procedures	15
5.1	Effects of Welding Variables	15
5.2	Purpose of Welding Procedure Specifications (WPSs)	17
5.3	Prequalified Welding Procedure Specifications	18
5.4	Guidelines for Preparing Prequalified WPSs	20
5.5	Qualifying Welding Procedures By Test	20
5.6	Examples	22
5.7	Approval of WPSs	22
6	Fabrication and Erection Guidelines	23
6.1	Fit-Up and Assembly	23
6.2	Backing and Weld Tabs	23
6.3	Weld Access Holes	24
6.4	Cutting and Gouging	25
6.5	Joint and Weld Cleaning	25
6.6	Preheat and Interpass Temperature	25
6.7	Welding Techniques	26
6.8	Special Welding Conditions	29
6.9	Weld Metal Mechanical Properties	29
6.10	Intermixing of Weld Deposits	33

7	Welding Techniques and Variables	.35
7.1	SMAW	.35
7.2	FCAW-ss	.36
7.3	FCAW-g	.37
7.4	SAW	.38
7.5	GMAW	.39
7.6	ESW/EGW	.40
8	Welder Qualification	.40
9	Weld Cracking	.40
9.1	Centerline Cracking	.41
9.2	Heat Affected Zone Cracking	.42
9.3	Transverse Cracking	.44
10	Weld Quality and Inspection	.44
10.1	Weld Quality	.44
10.2	Weld Quality and Process-Specific Influences	.46
10.3	Weld Inspection	.46
11	Arc Welding Safety	.49

Fabricators' and Erectors' Guide to Welded Steel Construction

1 Introduction/Background

This Fabricators' and Erectors' Guide to Welded Steel Construction has been produced by The Lincoln Electric Company in order to help promote high quality and cost-effective welding. This guide is not to be used as a substitute for the AWS D1.1 Structural Welding Code, or any other applicable welding code or specification, and the user bears the responsibility for knowing applicable codes and job requirements. Rather, this document incorporates references to the D1.1-96 code, and adds explanation, clarification, and guidelines to facilitate compliance with the code. At the time of writing, this guide reflects the current industry views with respect to steel fabrication, with specific emphasis on the new provisions that have been recently imposed for fabrication of structures designed to resist seismic loads. These provisions are largely drawn from the Federal Emergency Management Administration (FEMA) Document No. 267, produced by the SAC Consortium, whose members include the Structural Engineers Association of California, Applied Technology Council, and California Universities for Research and Earthquake Engineering. Another cited document is the AWS D1 Structural Welding Committee's Position Statement on the Northridge earthquake. Research is still underway, and additional provisions may be found that will further increase the safety of welded steel structures. The user of this document must be aware of changes that may occur to codes published after this guide, specific job requirements, and various interim recommendations that may affect the recommendations contained herein.

The January 1994 Northridge earthquake revealed a number of examples of lack of conformance to D1.1 code mandated provisions. Lack of conformance to code provisions, and the poor workmanship revealed in many situations, highlight the need for education. This document is one attempt to assist in that area.

The information contained herein is believed to be current and accurate. It is based upon the current technology, codes, specifications and principles of welding engineering. Any recommendations will be subject to change pending the results of ongoing research. As always, it is the responsibility of the Engineer of Record,

and not The Lincoln Electric Company, to specify the requirements for a particular project. The prerogative to specify alternate requirements is always within the authority of the Engineer of Record and, when more restrictive requirements are specified in contract documents, compliance with such requirements would supersede the preceding recommendations. Acceptance of criteria by the Engineer of Record that are less rigorous than the preceding does not change the recommendations of The Lincoln Electric Company.

2 Welding Processes

A variety of welding processes can be used to fabricate and erect buildings. However, it is important that all parties involved understand these processes in order to ensure high quality and economical fabrication. A brief description of the major processes is provided below.

2.1 SMAW

Shielded metal arc welding (SMAW), commonly known as stick electrode welding or manual welding, is the oldest of the arc welding processes. It is characterized by versatility, simplicity and flexibility. The SMAW process commonly is used for tack welding, fabrication of miscellaneous components, and repair welding. There is a practical limit to the amount of current that may be used. The covered electrodes are typically 9 to 18 inches long, and if the current is raised too high, electrical resistance heating within the unused length of electrode will become so great that the coating ingredients may overheat and "break down," potentially resulting in weld quality degradation. SMAW also is used in the field for erection, maintenance and repairs. SMAW has earned a reputation for depositing high quality welds dependably. It is, however, slower and more costly than other methods of welding, and is more dependent on operator skill for high quality welds.

The American Welding Society (AWS) publishes a variety of filler metal specifications under the jurisdiction of the A5 Committee; A5.1 addresses the particular requirements for mild steel covered electrodes used with the shielded metal arc welding process. The specification A5.5 similarly covers the low alloy electrodes.

For welding on steels with minimum specified yield strengths exceeding 50 ksi, all electrodes should be of the low hydrogen type with specific coatings that are designed to be extremely low in moisture. Water, or H₂O, will break down into its components hydrogen and oxygen under the intensity of the arc. This hydrogen can then enter into the weld deposit and may lead to unacceptable weld heat affected zone cracking under certain conditions. Low hydrogen electrodes have coatings comprised of materials that are very low in hydrogen.

The low hydrogen electrodes that fit into the A5.1 classification include E7015, E7016, E7018, and E7028. The E7015 electrodes operate on DC only. E7016 electrodes operate on either AC or DC. The E7018 electrodes operate on AC or DC and include approximately 25% iron powder in their coatings; this increases the rate at which metal may be deposited. An E7028 electrode contains approximately 50% iron powder in the coating, enabling it to deposit metal at even higher rates. However, this electrode is suitable for flat and horizontal welding only.

Under the low alloy specification, A5.5, a similar format is used to identify the various electrodes. The most significant difference, however, is the inclusion of a suffix letter and number indicating the alloy content. An example would be an “E8018-C3” electrode, with the suffix “-C3” indicating the electrode nominally contains 1% nickel. A “-C1” electrode nominally contains 2.5% nickel.

In AWS A5.1, the electrodes listed include both low hydrogen and non-low hydrogen electrodes. In AWS D1.1-96, Table 3.1, Group I steels may be welded with non-low hydrogen electrodes. This would include A36 steel. For Group II steels and higher, low hydrogen electrodes are required. These steels would include A572 grade 50. For most structural steel fabrication today, low hydrogen electrodes are prescribed to offer additional assurance against hydrogen induced cracking. When low hydrogen electrodes are used, the required levels of pre-heat (as identified in Table 3.2 of D1.1-96) are actually lower, offering additional economic advantages to the contractor.

All the low hydrogen electrodes listed in AWS A5.1 have minimum specified notch toughnesses of at least 20 ft. lb. at 0°F. There are electrode classifications that have no

notch toughness requirements (such as E6012, E6013, E6014, E7024) but these are not low hydrogen electrodes. Although there is no direct correlation between the low hydrogen nature of various electrodes and notch toughness requirements, in the case of SMAW electrodes in A5.1, the low hydrogen electrodes all have minimum notch toughness requirements.

Care and storage of low hydrogen electrodes — Low hydrogen electrodes must be dry if they are to perform properly. Manufacturers in the United States typically supply low hydrogen electrodes in hermetically sealed cans. When electrodes are so supplied, they may be used without any preconditioning; that is, they need not be heated before use. Electrodes in unopened, hermetically sealed containers should remain dry for extended periods of time under good storage conditions. Once electrodes are removed from the hermetically sealed container, they should be placed in a holding oven to minimize or preclude the pick-up of moisture from the atmosphere. These holding ovens generally are electrically heated devices that can accommodate several hundred pounds of electrodes. They hold the electrodes at a temperature of approximately 250-300°F. Electrodes to be used in fabrication are taken from these ovens. Fabricators and erectors should establish a practice of limiting the amount of electrodes discharged at any given time. Supplying welders with electrodes twice a shift — at the start of the shift and at lunch, for example — minimizes the risk of moisture pickup. However, the optional designator “R” indicates a low hydrogen electrode which has been tested to determine the moisture content of the covering after exposure to a moist environment for 9 hours and has met the maximum level permitted in ANSI/AWS A5.1-91. Higher strength electrodes will require even more rigorous control. Electrodes must be returned to the heated cabinet for overnight storage.

Once the electrode is exposed to the atmosphere, it begins to pick up moisture. The D1.1 code limits the total exposure time as a function of the electrode type (D1.1-96, paragraph 5.3.2.2, Table 5.1). Electrodes used to join high strength steels (which are particularly susceptible to hydrogen cracking) must be carefully cared for, and their exposure to the atmosphere strictly limited.

Some electrodes are supplied in cardboard containers. This is not commonly done for structural fabrication, although the practice can be acceptable if specific and appropriate guidelines are followed. The electrodes must be preconditioned before welding. Typically, this means baking them at temperatures in the 700 to 900°F range to reduce moisture. In all cases, the electrode manufacturer's guidelines should be followed to ensure a baking procedure that effectively reduces moisture without damage to the covering. Electrodes removed from damaged hermetically sealed cans should be similarly baked at high temperature. The manufacturer's guidelines should be consulted and followed to ensure that the electrodes are properly conditioned. Lincoln Electric's recommendations are outlined in Literature # C2.300.

Redrying low hydrogen electrodes — When containers are punctured or opened so that the electrode is exposed to the air, or when containers are stored under unusually wet conditions, low hydrogen electrodes pick up moisture. The moisture, depending upon the amount absorbed, impairs weld quality in the following ways:

1. If the base metal has high hardenability, even a small amount of moisture can contribute to underbead cracking.
2. A small amount of moisture may cause internal porosity. Detection of this porosity requires X-ray inspection or destructive testing.
3. A high amount of moisture causes visible external porosity in addition to internal porosity. Proper redrying restores the ability to deposit quality welds. The proper redrying temperature depends upon the type of electrode and its condition (D1.1-96, paragraph 5.3.2.4, Table 5.1).

2.2 FCAW

Flux cored arc welding (FCAW) uses an arc between a continuous filler metal electrode and the weld pool. The electrode is always tubular. Inside the metal sheath is a combination of materials that may include metallic powder and flux. FCAW may be applied automatically or semiautomatically.

The flux cored arc welding process has become the most popular semiautomatic process for structural steel fabrication and erection. Production welds that are short, that change direction, that are difficult to access, that must be done out-of-position (e.g., vertical or overhead), or that are part of a short production run, generally will be made with semiautomatic FCAW.

The flux cored arc welding process offers two distinct advantages over shielded metal arc welding. First, the electrode is continuous. This eliminates the built-in starts and stops that are inevitable with shielded metal arc welding. Not only does this have an economic advantage because the operating factor is raised, but the number of arc starts and stops, a potential source of weld discontinuities, is reduced.

Another major advantage is that increased amperages can be used with flux cored arc welding, with a corresponding increase in deposition rate and productivity. With the continuous flux cored electrodes, the tubular electrode is passed through a contact tip, where electrical energy is transferred to the electrode. The short distance from the contact tip to the end of the electrode, known as electrode extension or "stickout," limits the build up of heat due to electrical resistance. This electrode extension distance is typically 3/4 in. to 1 in. for flux cored electrodes, although it may be as high as two or three inches.

Within the category of flux cored arc welding, there are two specific subsets: self shielded flux core (FCAW-ss) and gas shielded flux core (FCAW-g). Self shielded flux cored electrodes require no external shielding gas. The entire shielding system results from the flux ingredients contained within the core of the tubular electrode. The gas shielded versions of flux cored electrodes utilize an externally supplied shielding gas. In many cases, CO₂ is used, although other gas mixtures may be used, e.g., argon/CO₂ mixtures. Both types of flux cored arc welding are capable of delivering weld deposits that meet the quality and mechanical property requirements for most structure applications. In general, the fabricator will utilize the process that offers the greatest advantages for the particular environment. Self shielded flux cored electrodes are better for field welding situations. Since no

externally supplied shielding gas is required, the process may be used in high winds without adversely affecting the quality of the deposit. With any of the gas shielded processes, wind shields must be erected to preclude interference with the gas shield in windy weather. Many fabricators have found self shielded flux core offers advantages for shop welding as well, since it permits the use of better ventilation.

Individual gas shielded flux cored electrodes tend to be more versatile than self shielded flux cored electrodes, and in general, provide better arc action. Operator appeal is usually higher. While the gas shield must be protected from winds and drafts, this is not particularly difficult in shop fabrication situations. Weld appearance and quality are very good. Higher strength gas shielded FCAW electrodes are available, while current technology limits self shielded FCAW deposits to 90 ksi tensile strength or less.

Filler metals for flux cored arc welding are specified in AWS A5.20 and A5.29. A5.20 covers mild steel electrodes, while A5.29 addresses low alloy materials. Positive polarity is always used for FCAW-g, although the self shielded electrodes may be used on either polarity, depending on their classification. Under A5.29 for alloy electrodes, a suffix letter followed by a number appears at the end. Common designations include “Ni1” indicating a nominal nickel content in the deposited metal of 1%. The letter “M” could appear at the end of the electrode classification. If this is done, the electrode has been designed for operation with mixed shielding gas, that is an argon-CO₂ blend that consists of 75 - 80% argon. Other suffix designators may be used that indicate increased notch toughness capabilities, and/or diffusible hydrogen limits.

Table 2.1 describes various FCAW electrodes listed in AWS A5.20 and A5.29. Some of the electrodes have minimum specified notch toughness values although others do not. Some are gas shielded, while others are self shielded. Some are restricted to single pass applications, and others have restrictions on the thickness for their application. The electrical polarity used for the various electrodes is also shown. For critical applications in buildings that are designed to resist seismic loading as determined by the Engineer of Record, only electrodes that are listed in Table 2.1 as having the required mini-

imum specified notch toughness levels should be used. The corresponding Lincoln Electric products are also shown.

Shielding gases for FCAW-g — Most of the gas shielded flux cored electrodes utilize carbon dioxide for the shielding media. However, electrodes may also be shielded with an argon-CO₂ mixture. All gases should be of welding grade with a dew point of -40°F or less. The carbon dioxide content is typically 10% to 25%, with the balance composed of argon. This is done to enhance welding characteristics. In order to utilize the argon based shielding gases, arc voltages are typically reduced by two volts from the level used with carbon dioxide shielding.

The selection of shielding gas may affect mechanical properties, including yield and tensile strength, elongation, and notch toughness. This is largely due to the difference in alloy recovery—that is, the amount of alloy transferred from the filler material to the weld deposit. Carbon dioxide is a reactive gas that may cause some of the alloys contained in the electrode (Mn, Si and others) to be oxidized, so that less alloy ends up in the deposit. When a portion of this active carbon dioxide is replaced with an inert gas such as argon, recovery typically increases, resulting in more alloy in the weld deposit. Generally, this will result in higher yield and tensile strengths, accompanied by a reduction in elongation. The notch toughness of the weld deposit may go up or down, depending on the particular alloy whose recovery is increased.

Storing FCAW electrodes — In general, FCAW electrodes will produce weld deposits which achieve hydrogen levels below 16 ml per 100 grams of deposited metal. These electrodes, like other products which produce deposits low in hydrogen, must be protected from exposure to the atmosphere in order to maintain hydrogen levels as low as possible, prevent rusting of the product and prevent porosity during welding. The recommended storage conditions are such that they maintain the condition of 90 grains of moisture per pound of dry air. Accordingly, the following storage conditions are recommended for FCAW electrodes in their original, unopened boxes and plastic bags.

Table 2.1 FCAW Electrode Classification

AWS Classification ¹	Common Lincoln Products	Single/ Multiple Pass ²	CVN Requirements ³ ft. lbf. @ °F.	Polarity	Shielding Gas
AWS A5.20					
E7XT-1	OS-70, 70C, 71, 71M, HD70, XLH70**	M	20 @ 0	DC+	YES
E7XT-2 ⁽⁴⁾	NA	S	NONE	DC+	YES
E7XT-3 ⁽⁴⁾	NR-1, 5	S	NONE	DC+	NO
E7XT-4	NS-3M	M	NONE	DC+	NO
E7XT-5, -5M	OS-75H*, 75C*	M	20 @ -20	DC+	YES
E7XT-6	NR-305	M	20 @ -20	DC+	NO
E7XT-7	NR-202, 311	M	NONE	DC-	NO
E7XT-8	NR-203M, 232, 203MP	M	20 @ -20	DC-	NO
E7XT-9	OS-70, 71, 71M, 70C HD70, XLH70**	M	20 @ -20	DC+	YES
E7XT-10 ⁽⁴⁾	NR-131, 131B	S	NONE	DC-	NO
E7XT-11	NR-211-MP ⁽⁷⁾	M	NONE	DC-	NO
E7XT-12, -12M	NA	M	20 @ -20	DC+	YES
E7XT-13	NR-204	S	NONE	DC-	NO
E7XT-14 ⁽⁶⁾	NR-150, 151, 151HS, 152	S	NONE	DC-	NO
E7XT-G	NA	M	NONE	Not Specified	Not Specified
E7XT-GS ⁽⁴⁾	NA	S	NONE	Not Specified	Not Specified
AWS A5.29⁽⁵⁾					
E6XT8 -K6	NR-203-NiC	M	20 @ -20	DC-	NO
E7XT4 -K2	NA	M	20 @ - 0	DC+	NO
E7XT6 -G	NR-311Ni	M	20 @ -20	DC-	NO
E7XT8 -K2	NR-203NiC+	M	20 @ -20	DC-	NO
E7XT8 -K6	NR-207, NR-400	M	20 @ -20	DC-	NO
E7XT8 -Ni1	NR-203 Ni (1%)	M	20 @ -20	DC-	NO
E7XT8 -Ni2	NR-450, 450-H	M	20 @ -20	DC-	NO
E8IT1 -Ni1	OS- 81Ni1-H	M	20 @ -20	DC+	YES

- NOTES: 1) An **“X”** in the electrode classification will designate the welding positions possible.
 A **“1”** represents an all position electrode while a **“O”** indicates a flat and horizontal position only electrode.
- 2) **“M”** indicates single or multiple pass; **“S”** indicates single pass only.
- 3) The first number represents the energy level in foot-pounds, and the second number is the test temperature in degrees Fahrenheit.
- 4) These single pass electrodes are specifically excluded from prequalified usage in AWS D1.1-96, Table 3.1.
- 5) Not all A5.29 electrodes are listed, as many are of a strength level (>80 ksi) that is not required for most building construction, or are classified in the post weld heat treated (stress relieved) condition.
- 6) Not recommended for thicknesses greater than 3/16 inch.
- 7) Base metal thickness shall not exceed 1/2 inch.

* *These products have additional classification modifiers “J” and “H4”.*

** *XLH70 also has additional optional classification modifier “H4”.*

Ambient Temperature		Maximum % Relative Humidity
Degrees F	Degrees C	
60 - 70	16 - 21	80
70 - 80	21 - 27	60
80 - 90	27 - 32	45
90 - 100	32 - 38	30

For best results, electrodes should be consumed as soon as practicable. However, they may be stored up to three years from the date of manufacture. The Lincoln distributor or sales representative should be consulted if there is a question as to when the electrodes were made.

Once the electrode packaging is opened, Innershield and Outershield electrodes can be subject to contamination from atmospheric moisture. Care has been taken in the design of these products to select core ingredients that are essentially resistant to moisture pick-up; however, condensation of the moisture from the atmosphere onto the surface of the electrode can be sufficient to degrade the product.

The following minimum precautions should be taken to safeguard product after opening the original package. Electrode should be used within approximately 1 week after opening the original package. Opened electrode should not be exposed to damp, moist conditions or extremes in temperature and/or humidity where surface condensation can occur. Electrodes mounted on wire feeders should be protected against condensation. It is recommended that electrode removed from its original packaging be placed in poly bags (4 mil minimum thickness) when not in use.

In the case of FCAW-s, excessively damp electrodes can result in higher levels of spatter, poorer slag cover and porosity. FCAW-g electrodes will display high moisture levels in the form of gas tracks, higher spatter and porosity. Any rusty electrode should be discarded.

Products used for applications requiring more restrictive hydrogen control — The AWS specification for flux cored electrodes, ANSI/AWS A5.20, states that “Flux cored arc welding is generally considered to be a low hydrogen welding process.” To further clarify the issue, this specification makes available optional supplemental designators for maximum diffusible hydrogen levels of 4, 8 and 16 ml per 100 grams of deposited weld metal.

Some Innershield and Outershield products have been designed and manufactured to produce weld deposits meeting more stringent diffusible hydrogen requirements. These electrodes, usually distinguished by an “H” added to the product name, will remain relatively dry under recommended storage conditions in their original, unopened package or container.

For critical applications in which the weld metal hydrogen must be controlled (usually H8 or lower), or where shipping and storage conditions are not controlled or known, only hermetically sealed packaging is recommended. Innershield and Outershield electrodes are available in hermetically sealed packages on a special order basis.

Once the package has been opened, the electrode should not be exposed to conditions exceeding 80% relative humidity for a period greater than 16 hours, or any less humid condition for more than 24 hours. Conditions that exceed 80% RH will decrease the maximum 16 hour exposure period.

After exposure, hydrogen levels can be reduced by conditioning the electrode. Electrodes may be conditioned at a temperature of 230°F ± 25°F for a period of 6 to 12 hours, cooled and then stored in sealed poly bags (4 mil minimum thickness) or equivalent. Electrodes on plastic spools should not be heated at temperatures in excess of 150°F. Rusty electrodes should be discarded.

2.3 SAW

Submerged arc welding (SAW) differs from other arc welding processes in that a layer of fusible granular material called flux is used for shielding the arc and the molten metal. The arc is struck between the workpiece and a bare wire electrode, the tip of which is submerged in the flux. Since the arc is completely covered by the flux, it is not visible and the weld is made without the flash, spatter, and sparks that characterize the open-arc processes. The nature of the flux is such that very little smoke or visible fumes are released to the air.

Typically, the process is fully mechanized, although semi-automatic operation is often utilized. The electrode is fed mechanically to the welding gun, head, or heads. In semi-automatic welding, the welder moves the gun, usually equipped with a flux-feeding device, along the joint.

High currents can be used in submerged arc welding and extremely high heat input levels can be developed. Because the current is applied to the electrode a short distance above its arc, relatively high amperages can be used on small diameter electrodes, resulting in extremely high current densities. This allows for high deposition rates and deep penetration.

Welds made under the protective layer of flux are excellent in appearance and spatter free. Since the process develops a minimum amount of smoke, the surrounding plate surfaces remain clear of smoke deposits. The high quality of submerged arc welds, the high deposition rates, the deep penetration characteristics, and the easy adaptability of the process to full mechanization make it popular for the manufacture of plate girders and fabricated columns.

One of the greatest benefits of the SAW process is freedom from the open arc. This allows multiple arcs to be operated in a tight, confined area without the need for extensive shields to guard the operators from arc flash. Yet this advantage also proves to be one of the chief drawbacks of the process; it does not allow the operator to observe the weld puddle. When SAW is applied semiautomatically, the operator must learn to propel the gun carefully in a fashion that will ensure uniform bead contour. The experienced operator relies on the uniform formation of a slag blanket to indicate the nature of the deposit. For single pass welds, this is mastered fairly readily; however, for multiple pass welding, the degree of skill required is significant. Therefore, most submerged arc applications are mechanized. The nature of the joint must then lend itself to automation if the process is to prove viable. Long, uninterrupted straight seams are ideal applications for submerged arc. Short, intermittent welds are better made with one of the open arc processes.

Two electrodes may be fed through a single electrical contact tip, resulting in higher deposition rates. Generally known as parallel electrode welding, the Lincoln trade name for this is Tiny Twin® or Twin Arc®. The equipment is essentially the same as that used for single electrode welding, and parallel electrode welding procedures may be prequalified under AWS D1.1-96.

Multiple electrode SAW refers to a variation of submerged arc which utilizes at least two separate power supplies, two separate wire drives, and feeds two electrodes independently. Some applications such as the manufacture of line pipe may use up to five independent

electrodes in a multiple electrode configuration. AC welding currently is typically used for multi-electrode welding. If DC current is used, it usually is limited to the lead electrode to minimize the potentially negative interaction of magnetic fields between the two electrodes.

Submerged arc filler materials are classified under AWS A5.17 for mild steel and AWS A5.23 for low alloy filler materials. Both fluxes and electrodes are covered under these specifications. Since submerged arc is a two-component process, that is, flux and electrode, the classification system is slightly different than for other filler materials.

Electrodes are classified based on the composition of the electrode. Under A5.17, the electrode will carry a classification that consists of two letters, one or two numerical digits and, in some cases, a final letter. The first letter is an E, which stands for electrode. The second letter will be L, M, or H, referring to a low, medium, or high level of manganese in the electrode. The next one or two digits refer to the nominal carbon content in hundredths of a percent. A “12” in this location, for example, would indicate a nominal carbon content of 0.12%. It should be emphasized that this is the nominal value; it is possible to have higher and lower carbon contents in a specific electrode. In some cases, the electrode will be made of killed steel. When this is the case, silicon normally is added and the electrode will have a “K” at the end of the classification (e.g., EM13K).

Electrodes classified under A5.23, the low alloy variety, have a more complex nomenclature, because of the variety of alloys that may be involved. The most important alloys for structural welding are the “Ni,” or nickel alloys, and “W,” or weathering alloys (e.g., ENi1K).

Fluxes are always classified in conjunction with an electrode. The flux-electrode combination must meet specific mechanical property requirements. After a flux is selected and a classification test plate welded, a flux-electrode classification may be established. Specimens are extracted from the weld deposit to obtain the mechanical properties of the flux-electrode combination. The classification will follow the format of an “F” followed by a single or two digit number, an “A” or “P,” a single digit and a hyphen which separates the electrode classification. Thus, a typical flux-electrode may be classified as an F7A2-EM12K. The “F” stands for flux, and the “7” indicates all of the following: a 70-95 ksi tensile strength deposit, a 58 ksi minimum yield strength, and a

minimum of 22% elongation. The “A” indicates the deposit is tested in the as-welded condition. The “2” indicates 20 ft. lbf. at -20°F, and the balance of the classification identifies the electrode used.

Because of the popularity of the submerged arc process for pressure vessel fabrication where assemblies are routinely stress relieved, submerged arc products may be classified in the post weld heat treated, or stress relieved, condition. When this is done, a “P” replaces the “A.” For structural work, which is seldom stress relieved, the “A” classification is more common.

For products classified under A5.23, a format similar to that of A5.17 is used, with this major exception: at the end of the flux-electrode classification, a weld deposit composition is specified. For example, an F7A2-ENi1-Ni1 would indicate that the electrode, an ENi1, delivers an F7A2 deposit when used with a specific flux. In addition, the deposit has a composition that meets the requirements of an Ni1. In this case, a nickel bearing electrode deposits a weld that contains nickel. The example is straightforward. However, it is also possible to use alloy fluxes which, with mild steel electrodes, are capable of delivering alloy weld metal. In this case, a typical classification may be an F7A2-EL12-Ni1. In this example, an EL12 electrode (a non-alloy electrode that contains a low level of manganese) is used with an alloy flux. The result is an alloyed deposit. This is commonly done when nickel bearing deposits are desired on weathering steel that will not be painted.

Only part of the flux deposited from a hopper or a gun is fused in welding. The unfused, granular flux may be recovered for future use and is known as reclaimed flux. The unmelted flux does not undergo chemical changes and may therefore be capable of delivering quality welds when used the next time. However, this flux can be contaminated in the act of recovery. If it comes in contact with oil, moisture, dirt, scale or other contaminants, the properties of the weld deposit made with reclaimed flux may be adversely affected. Care should be exercised to ensure that flux is not thus contaminated. Another problem with reclaimed flux is the potential for the breakdown of particles and the modification of the particle size distribution. This can affect the quality and/or properties. The method of flux recovery can range from sweeping up the flux with broom and pans, to vacuum recovery systems; the method chosen should take into account the need to avoid contamination.

Larger pieces of fused slag should be separated from the recovered flux in order to avoid flux feeding problems. The automated systems typically have screening to handle this. The fused slag may be chemically different than the unfused flux. For less critical applications, this slag may be crushed and thoroughly intermixed with new flux. This is sometimes called “recycled flux,” but since reclaimed flux is sometimes referred to by the same term, a better description for this product is “crushed slag.” Performance and mechanical properties of crushed slag may differ from those of virgin flux. AWS D1.1-96 requires that crushed slag must be classified in much the same way as new flux. (See AWS D1.1-96, paragraph 5.3.3.4)

Flux must be stored so that it remains dry. The manufacturer’s guidelines regarding storage and usage of the flux must be followed. In use, granules of flux must not come in direct contact with water since weld cracking can result. Fluxes can be contaminated with moisture from the atmosphere, so exposure should be limited. When not in use, flux hoppers should be covered or otherwise protected from the atmosphere. Lincoln Electric’s recommendations for storage and handling of flux are outlined in Literature # C5.660.

2.4 GMAW

Gas metal arc welding (GMAW) utilizes equipment much like that used in flux cored arc welding. Indeed, the two processes are very similar. The major differences are: gas metal arc uses a solid or metal cored electrode, and leaves no appreciable amount of residual slag. Gas metal arc has not been a popular method of welding in the typical structural steel fabrication shop because of its sensitivity to mill scale, rust, limited puddle control, and sensitivity to shielding loss. Newer GMAW metal cored electrodes, however, are beginning to be used in the shop fabrication of structural elements with good success.

A variety of shielding gases or gas mixtures may be used for GMAW. Carbon dioxide (CO₂) is the lowest cost gas, and while acceptable for welding carbon steel, the gas is not inert but active at elevated temperatures. This has given rise to the term MAG (metal active gas) for the process when (CO₂) is used, and MIG (metal inert gas) when predominantly argon-based mixtures are used.

While shielding gas is used to displace atmospheric oxygen, it is possible to add smaller quantities of oxygen into

mixtures of argon — generally at levels of 2 - 8%. This helps stabilize the arc and decreases puddle surface tension, resulting in improved wetting. Tri- and quad-mixes of argon, oxygen, carbon dioxide and helium are possible, offering advantages that positively affect arc action, deposition appearance and fume generation rates.

Short arc transfer is ideal for welding on thin gauge materials. It is generally not suitable for structural steel fabrication purposes. In this mode of transfer, the small diameter electrode, typically 0.035 in. or 0.045 in., is fed at a moderate wire feed speed at relatively low voltages. The electrode will touch the workpiece, resulting in a short in the electrical circuit. The arc will actually go out at this point, and very high currents will flow through the electrode, causing it to heat and melt. Just as excessive current flowing through a fuse causes it to blow, so the shorted electrode will separate from the work, initiating a momentary arc. A small amount of metal will be transferred to the work at this time.

The cycle will repeat itself again once the electrode shorts to the work. This occurs somewhere between 60 and 200 times per second, creating a characteristic buzz to the arc. This mode of transfer is ideal for sheet metal, but results in significant fusion problems if applied to heavy materials. A phenomenon known as cold lap or cold casting may result where the metal does not fuse to the base material. This is unacceptable since the welded connections will have virtually no strength. Great caution must be exercised in the application of the short arc mode to heavy plates. The use of short arc on heavy plates is not totally prohibited however, since it is the only mode of transfer that can be used out-of-position with gas metal arc welding, unless specialized equipment is used. Weld joint details must be carefully designed when short arc transfer is used. Welders must pass specific qualification tests before using this mode of transfer. The mode of transfer is often abbreviated as GMAW-s, and is not prequalified by the D1.1 code.

Globular transfer is a mode of gas metal arc welding that results when high concentrations of carbon dioxide are used, resulting in an arc that is rough with larger globs of metal ejected from the end of the electrode. This mode of transfer, while resulting in deep penetration, generates relatively high levels of spatter. Weld appearance can be poor and it is restricted to the flat and horizontal position. Globular transfer may be preferred over spray transfer because of the low cost of CO₂ shielding gas and the lower level of heat experienced by the operator.

Spray arc transfer is characterized by high wire feed speeds at relatively high voltages. A fine spray of molten drops, all smaller in diameter than the electrode diameter, is ejected from the electrode toward the work. Unlike short arc transfer, the arc in spray transfer is continuously maintained. High quality welds with particularly good appearance are the result. The shielding used for spray arc transfer is composed of at least 80% argon, with the balance made up of either carbon dioxide or oxygen. Typical mixtures would include 90-10 argon-CO₂, and 95-5 argon-oxygen. Other proprietary mixtures are available from gas suppliers. Relatively high arc voltages are used with the spray mode of transfer. However, due to the intensity of the arc, spray arc is restricted to applications in the flat and horizontal position, because of the puddle fluidity, and lack of a slag to hold the molten metal in place.

Pulsed arc transfer utilizes a background current that is continuously applied to the electrode. A pulsing peak current is optimally applied as a function of the wire feed speed. With this mode of transfer, the power supply delivers a pulse of current which, ideally, ejects a single droplet of metal from the electrode. The power supply returns to a lower background current which maintains the arc. This occurs between 100 and 400 times per second. One advantage of pulsed arc transfer is that it can be used out-of-position. For flat and horizontal work, it may not be as fast as spray transfer. However, used out-of-position, it is free of the problems associated with gas metal arc short circuiting mode. Weld appearance is good and quality can be excellent. The disadvantage of pulsed arc transfer is that the equipment is slightly more complex and more costly. The joints are still required to be relatively clean, and out-of-position welding is still more difficult than with processes that generate a slag that can support the molten puddle.

Metal cored electrodes are a relatively new development in gas metal arc welding. This is similar to flux cored arc welding in that the electrode is tubular, but the core material does not contain slag forming ingredients. Rather, a variety of metallic powders is contained in the core. The resulting weld is virtually slag-free, just as with other forms of GMAW. The use of metal cored electrodes offers many fabrication advantages. They have increased ability to handle mill scale and other surface contaminants. Finally, metal cored electrodes permit the use of high amperages that may not be practical with solid electrodes, resulting in potentially higher deposition rates. The properties obtained from metal

cored deposits can be excellent. Appearance is very good. Because of the ability of the filler metal manufacturer to control the composition of the core ingredients, mechanical properties obtained from metal cored deposits may be more consistent than those obtained with solid electrodes. However, metal cored electrodes are in general more expensive.

2.5 ESW/EGW

Electroslag and electrogas welding (ESW/EGW) are closely related processes that offer high deposition welding in the vertical plane. Properly applied, these processes offer significant savings over alternative out-of-position methods and in many cases, a savings over flat position welding. Although the two processes have similar applications and mechanical set up, there are fundamental differences in the arc characteristics.

Electroslag and electrogas are mechanically similar in that both utilize copper dams or shoes that are applied to either side of a square edged butt joint. An electrode or multiple electrodes are fed into the joint. A starting sump is typically applied for the beginning of the weld. As the electrode is fed into the joint, a puddle is established that progresses vertically. The copper dams, which are commonly water cooled, chill the weld metal and prevent it from escaping from the joint. The weld is completed in one pass.

These processes may be used for groove welds in butt, corner and tee joints. Typical applications involve heavier plate, usually 1" or thicker. Multiple electrodes may be used in a single joint, allowing very heavy plate up to several inches thick to be joined in a single pass. Because of the sensitivity of the process to the variety of variables involved, specific operator training is required, and the D1.1-96 code requires welding procedures to be qualified by test.

In building construction, applications for ESW/EGW with traditional connection designs are somewhat limited. However, they can be highly efficient in the manufacture of tree columns. In the shop, the beam flange-to-column welds can be made with the column in the horizontal plane. With the proper equipment and tooling, all four flange welds can be made simultaneously. In addition, continuity plate welds can be made with ESW/EGW. Future connection designs may utilize configurations that are more conducive to these processes.

Another common application is for the welding of continuity plates inside box columns. It is possible to weld three sides of the continuity plate to the interior of the box prior to closing the box with the fourth side. However, once this closure is made, access to the final side of the continuity plate is restricted. It is possible to use these processes to make this final closure weld by operating through a hole in the outside of the box column. This approach is very popular in Asia, where box columns are widely used.

In electroslag welding, a granular flux is metered into the joint during the welding operation. At the beginning, an arc, similar to that of submerged arc welding, is established between the electrode and the sump.

After the initial flux is melted into a molten slag, the reaction changes. The slag, which is carefully designed to be electrically conductive, will conduct the welding current from the electrode through the slag into the pieces of steel to be joined. As high currents are passed through the slag, it becomes very hot. The electrode is fed through the hot slag and melts. Technically, electroslag welding is not an arc welding process, but a resistance welding process. Once the arc is extinguished and the resistance melting process is stabilized, the weld continues vertically to completion. A small amount of slag is consumed as it chills against the water cooled copper shoes. In some cases, steel dams instead of copper dams are used to retain the puddle. After completion of the weld, the steel dams stay in place, and become part of the final product. Slag must be replenished, and additional flux is continuously added to compensate for the loss.

One aspect of electroslag welding that must be considered is the very high heat input associated with the process. This causes a large heat affected zone (HAZ) that may have a lower notch toughness. Electroslag welding is different from electrogas, inasmuch as no flux is used. Electroslag welding is a true arc welding process and is conceptually more like gas metal arc or flux cored arc welding. A solid or tubular electrode is fed into the joint, which is flooded with an inert gas shield. The arc progresses vertically while the puddle is retained by the water cooled dams.

The Lincoln Vertishield® system uses a self shielded flux cored electrode, and while no gas is required, it is classified as EGW since it is an open arc process.

The HAZ performance is dependent not only on the heat input, but also on the nature of the steel. While all processes develop a heat affected zone, the large size of the electroslog heat affected zone justifies additional scrutiny. Advances in steel technology have resulted in improved steels, featuring higher cleanliness and toughness, that better retain the HAZ properties in ESW/EGW welds.

3 Welding Process Selection

Any of the common arc welding processes can be used to achieve the quality required for structural steel applications. While each may have a particular area of strength and/or weakness, the primary consideration as to which process will be used is largely driven by cost. The availability of specialized equipment in one fabrication shop, compared to the capabilities of a second shop, may dictate significantly different approaches, both of which may prove to be cost effective. A history of successful usage offers a strong incentive for the fabricator to continue using a given process. The reasons for this go well beyond familiarity and comfort with a specific approach. When welders and procedures are established with a given process, significant costs will be incurred with any change to a new approach.

3.1 Joint Requirements

Each individual weld joint configuration and preparation has certain requirements of the welding process in order to achieve low cost welding. Four characteristics must be considered: deposition rate, penetration ability, out-of-position capability, and high travel speed capacity. Each process exhibits different capabilities in these realms. Once the joint and its associated requirements are analyzed, they should be compared to the various process options and the ability of the process to achieve those requirements. A proper match of weld joint requirements and process capabilities will lead to dependable and economical fabrication.

Some welds, such as large fillet welds and groove welds require that **high deposition rate** welding be used (Fig. 3-1) for the most economical fabrication. The cost of making these welds will be determined largely by the deposition rate of the process. The amount of weld material required may be measured in pounds per foot of joint. Once the deposition rate of a process in pounds per hour is known, it is possible to determine the number of

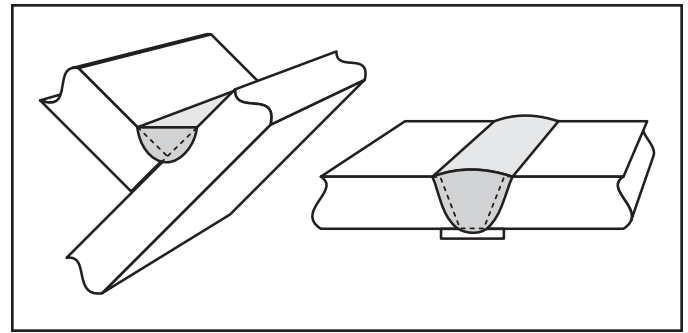

Figure 3-1 Joints requiring substantial fill

feet of weld that can be made in a given hour assuming 100% arc time. This, of course, translates directly to productivity rates.

The second criterion imposed by weld joints is the requirement for penetration. Examples are listed under Fig. 3-2 and would include any complete joint penetration groove weld that has a root face dimension. These joints will be made by welding from one side and back gouging from the second to ensure complete fusion. With deeper penetration afforded by the welding process, a smaller amount of base metal will be required to be removed by back gouging. Subsequent welding will then be proportionately reduced as well.

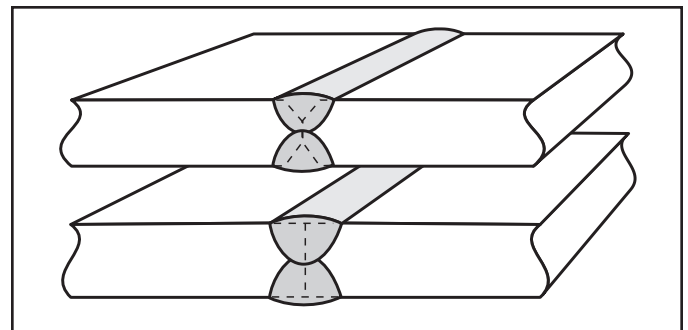

Figure 3-2 Joints requiring substantial penetration

While all welding requires fusion, not all joints require deep penetration. For example, simple fillet welds are required by AWS D1.1-96 to have fusion to the root of the joint, but are not required to have penetration beyond the root. This has a practical basis: verification of penetration beyond the root is impossible with visual inspection. Fusion to the root, and not necessarily beyond, ensures that sufficient strength is generated, provided the weld is properly sized. While penetration can be verified with ultrasonic inspection, fillet welds routinely receive only visual or magnetic particle inspection. Thus, no penetra-

tion beyond the root is required, nor is design credit given to deeper penetration in fillet welds if it happens to be present. Figure 3-3 illustrates this requirement.

The out-of-position capability of a given welding process refers to the ability to deposit weld metal in the vertical or overhead positions. It is generally more economical to position the work in the flat and horizontal positions. However, this is usually impossible for field erection, and may be impractical under other conditions.

The ability to obtain high travel speeds is important for small welds. It may not be possible for a high deposition welding process to be used at high travel speeds. The size of the droplet transferred, puddle fluidity, surface tension, and other factors combine to make some processes more capable of high travel speeds than others.

3.2 Process Capabilities

After the joint is analyzed and specific requirements determined, these are compared to the capabilities of various processes. The process with capabilities most closely matching the requirements typically will be the best and most economical option.

Submerged arc welding and electroslag/electrogas welding have the greatest potential to deliver high deposition rates. Multiple electrode applications of submerged arc extend this capability even further. For joints requiring high deposition rates, submerged arc and electroslag/electrogas welding are ideal processes to contribute to low cost welding. When the specific conditions are not conducive to SAW but high deposition rates are still required, flux cored arc welding may be used. The larger diameter electrodes, which run at higher electrical currents, are preferred.

Deep penetration is offered by the submerged arc welding process. While electroslag/electrogas also offers deep penetration, the joints on which electroslag are used typically do not require this capability. Where open arc processes are preferred, gas shielded flux cored welding may offer deep penetration.

Out-of-position capability is strongest for the flux cored and shielded metal arc welding processes. The slag coatings that are generated by these processes can be instrumental in retaining molten weld metal in the vertical and overhead positions. Submerged arc is not applicable for these joints.

The requirement for high travel speed capability is fairly limited in terms of welding structural steel members. This typically consists of the travel speed associated with making a 1/4 in. fillet weld. All of the popular processes, with the exception of electroslag/electrogas, are capable of making 1/4 in. fillet welds under the proper conditions. Among the variables that need to be considered are electrode size and procedure variables. A common mistake of fabricators is to utilize a process and procedure capable of extremely high deposition rates, but limited travel speeds. Oversized welds can result from the inability to achieve high travel speeds. A more economical approach would be to optimize the procedure according to the desired travel speed. This may result in a lower deposition rate but a lower overall cost because overwelding has been eliminated.

3.3 Special Situations

Self shielded flux cored welding is ideal for outdoor conditions. Quality deposits may be obtained without the erection of special wind shields and protection from drafts. Shielded metal arc welding is also suitable for these conditions, but is considerably slower.

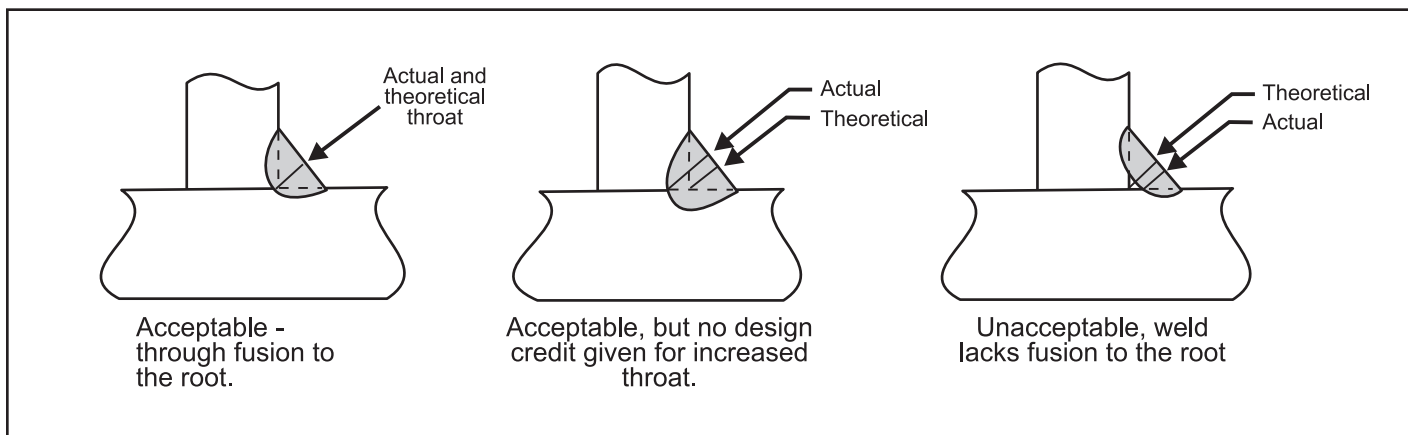

Figure 3-3 Fillet weld requirements

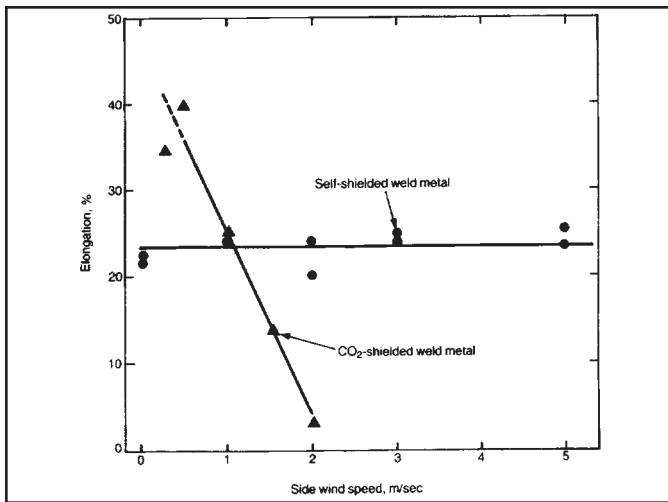

Figure 3-4a Comparison of the effect of side wind on tensile elongation of: (a) CO₂-shielded and (b) self shielded ferritic steel weld metals.

(source: Self-Shielded Arc Welding, T. Boniszewski, 1992.)

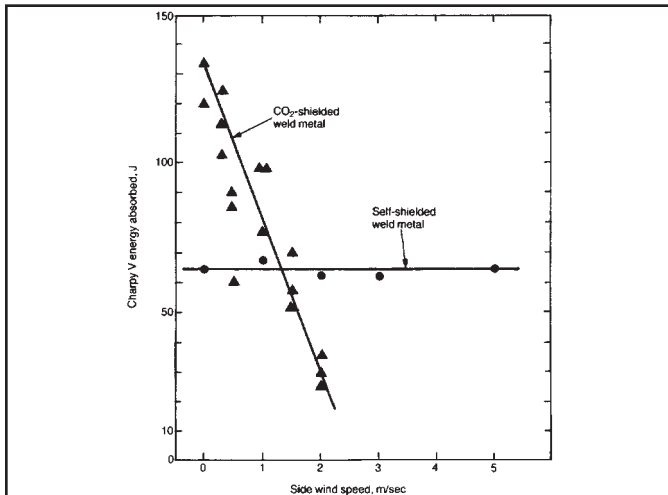

Figure 3-4b Comparison of the effect of side wind speed on Charpy V-notch impact toughness of: (a) CO₂-shielded at room temperature and (b) self shielded ferritic steel weld metals at 0°C.

(source: Self-Shielded Arc Welding, T. Boniszewski, 1992.)

The welding process of choice for field erectors for the last 25 years has been FCAW-ss. It has been the commonly used process for fabrication of steel structures throughout the United States. Its advantages are reviewed in order to provide an understanding of why it has been the preferred process. In addition, its limitations are outlined to highlight areas of potential concern.

The chief advantage of the FCAW-ss process is its ability to deposit quality weld metal under field conditions, which usually involve wind. The graph shown in Figure

3-4 illustrates the effect of shielding gas loss on weld deposits, as well as the resistance to this problem with the FCAW-ss process. The code specifically limits wind velocity in the vicinity of a weld to a maximum of 5 miles per hour (2.3 m/s) (D1.1-96, paragraph 5.12.1). In order to utilize gas shielded processes under these conditions, it is necessary to erect windshields to preclude movement of the shielding gas with respect to the molten weld puddle. While tents and other housings can be created to minimize this problem, such activities can be costly and are often a fire hazard. In addition, adequate ventilation must be provided for the welder. The most efficient windshields may preclude adequate ventilation. Under conditions of severe shielding loss, weld porosity will be exhibited. At much lower levels of shielding loss, the mechanical properties (e.g., notch toughness and ductility) may be negatively affected, although there will be no obvious evidence that this is taking place.

A variety of other gas-related issues are also eliminated, including ensuring availability of gas, handling of high pressure cylinders (always a safety concern), theft of cylinders, protection of gas distribution hosing under field conditions, and the cost of shielding gas. Leaks in the delivery system obviously waste shielding gas, but a leak can also allow entry of air into the delivery system. Weld quality can be affected in the same way as shielding loss. Most field erectors have found it advantageous to utilize the self-shielded process and circumvent all such potential problems.

Some projects permit **multiple welding heads** to be simultaneously operated in the same general vicinity. For such applications, submerged arc is an ideal choice. Because of the lack of arc flash, one operator can control multiple arcs that are nearly impossible to control in a situation where the arc intensity from one arc would make it difficult to carefully control another. A typical example would be the use of welding systems that simultaneously make fillet welds on opposing sides of stiffeners.

The easiest way to **control smoke and fumes** in the welding environment is to limit their initial generation. Here, submerged arc is ideal. Smoke exhaust guns are available for the flux cored arc welding processes. The most effective process for use with these smoke exhaust guns is FCAW-ss. Because the process is self shielded, there is no concern about the disruption of the gas shielding. See **11** on arc welding safety.

4 Welding Cost Analysis

Welding is a labor intensive technology. Electricity, equipment depreciation, electrodes, gases, and fluxes constitute a very small portion of the total welding cost. Therefore, the prime focus of cost control will be reducing the amount of time required to make a weld.

The following example is given to illustrate the relative costs of material and labor, as well as to assess the effects of proper process selection. The example to be considered is the groove weld of beam flange to column connections. Since this is a multiple pass weld, the most appropriate analysis method is to consider the welding cost per weight of weld metal deposited, such as \$/lb. Other analysis methods include cost per piece, ideal for manufacturers associated with the production of identical parts on a repetitive basis. Another method is cost per length, appropriate for single pass welds with substantial length. The two welding processes to be considered are shielded metal arc welding and flux cored arc welding. Either would generate high quality welds when properly used.

To calculate the cost per weight of weld metal deposited, an equation taking the following format is used:

$$\text{Cost per weight} = \frac{\text{Electrode Cost}}{\text{Efficiency}} + \frac{\text{Labor + Overhead Rate}}{(\text{Deposition Rate}) (\text{Operating Factor})}$$

The cost of the electrode is simply the purchase cost of the welding consumable used. Not all of this filler metal is converted directly to deposited weld metal. There are losses associated with slag, spatter, and in the case of SMAW, the stub loss (the end portion of the electrode that is discarded). To account for these differences, an efficiency factor is applied. The following efficiency factors are typically used for the various welding processes:

Process	Efficiency
SMAW	60%
FCAW	80%
GMAW	90% (CO ₂ shielding)
	98% (Mixed gas)
SAW	100% (Flux not included)

The cost to deposit the weld metal is determined by dividing the applicable labor and overhead rate by the deposition rate, that is, the amount of weld metal deposited in a theoretical, continuous one hour of production. This cannot be maintained under actual conditions since welding will be interrupted by many factors, including slag removal, replacement of electrode, repositioning of

the work or the welder with respect to the work, etc. To account for this time, an “operating factor” is used which is defined as the “arc-on” time divided by the total time associated with welding activities. For SMAW, replacement of electrodes takes place approximately every minute because of the finite length of the electrodes used. The following operating factors are typically used for the various processes and method of application:
Operating factors for any given process can vary widely,

Method	Operating Factor
Manual SMAW	30%
Semiautomatic	40%
Mechanized	50%

depending on what a welder is required to do. In shop situations, a welder may receive tacked assemblies and be required only to weld and clean them. For field erection, the welder may “hang iron,” fit, tack, bolt, clean the joint, reposition scaffolding and other activities in addition to welding. Obviously operating factors will be significantly reduced under these conditions.

The following examples are the actual procedures used by a field erector. The labor and overhead cost does not necessarily represent actual practice. The operating factors are unrealistically high for a field erection site, but have been used to enable comparison of the relative cost of filler metals vs. the labor required to deposit the weld metal, as well as the difference in cost for different processes. Once the cost per deposited pound is known, it is relatively simple to determine the quantity of weld metal required for a given project, and multiply it by the cost per weight to determine the cost of welding on the project.

Process	SMAW	FCAW
Electrode Classification	E7018	E70TG-K2
Electrode Diameter	3/16”	7/64”
Amperage	225	430
Voltage	N.A.	27
Electrode Efficiency	60%	80%
Electrode Cost	\$1.23/lb.	\$2.27/lb.
Operating Factor	30%	40%
Deposition Rate	5.5 lb./hr.	14.5 lb./hr.
Labor and Overhead Rate	\$50/hr	\$50/hr.

For SMAW:

$$\text{Cost per weight} = \frac{\$1.23}{60\%} + \frac{\$50.00}{(5.5) (30\%)} = \$2.05 + \$30.30 = \$32.35/\text{lb.}$$

For FCAW:

$$\text{Cost per weight} = \frac{\$2.27}{80\%} + \frac{\$50.00}{(14.5) (40\%)} = \$2.84 + \$8.62 = \$11.46/\text{lb.}$$

In the SMAW example, the electrode cost is approximately 6% of the total cost. For the FCAW example, primarily due to a decrease in the labor content, the electrode cost is 25% of the total. By using FCAW, the total cost of welding was decreased approximately 65%. While the FCAW electrode costs 85% more than the SMAW electrode, the higher electrode efficiency reduces the increase in electrode cost to only 39%.

The first priority that must be maintained when selecting welding processes and procedures is the achievement of the required weld quality. For different welding methods which deliver the required quality, it is generally advantageous to utilize the method that results in higher deposition rates and higher operating factors. This will result in reduced welding time with a corresponding decrease in the total building erection cycle, which will generally translate to a direct savings for the final owner, not only lowering the cost of direct labor, but also reducing construction loan costs.

5 Welding Procedures

Within the welding industry, the term “Welding Procedure Specification” (or WPS) is used to signify the combination of variables that are to be used to make a certain weld. The terms “Welding Procedure,” or simply “Procedure,” may be used. At a minimum, the WPS consists of the following:

WPS Variables

Process	(SMAW, FCAW, etc.)
Electrode specification	(AWS A5.1, A5.20, etc.)
Electrode classification	(E7018, E71T-1, etc.)
Electrode diameter	(1/8 in., 5/32 in., etc.)
Electrical characteristics	(AC, DC+, DC-)
Base metal specification	(A36, A572 Gr50, etc.)
Minimum preheat and interpass temperature	
Welding current (amperage)/wire feed speed	
Arc voltage	
Travel speed	
Position of welding	
Post weld heat treatment	
Shielding gas type and flow rate	
Joint design details	

The welding procedure is somewhat analogous to a cook’s recipe. It outlines the steps required to make a weld of the required quality under specific conditions.

5.1 Effects of Welding Variables

The effects of the variables are somewhat dependent on the welding process being employed, but general trends apply to all the processes. It is important to distinguish the difference between constant current (CC) and constant voltage (CV) electrical welding systems. Shielded metal arc welding is always done with a CC system. Flux cored welding and gas metal arc welding generally are performed with CV systems. Submerged arc may utilize either.

Amperage is a measure of the amount of current flowing through the electrode and the work. It is a primary variable in determining heat input. Generally, an increase in amperage means higher deposition rates, deeper penetration, and more admixture. The amperage flowing through an electrical circuit is the same, regardless of where it is measured. It may be measured with a tong meter or with the use of an electrical shunt. The role of amperage is best understood in the context of heat input and current density considerations. For CV welding, an increase in wire feed speed will directly increase amperage. For SMAW on CC systems, the machine setting determines the basic amperage, although changes in the arc length (controlled by the welder) will further change amperage. Longer arc lengths reduce amperage.

Arc voltage is directly related to arc length. As the voltage increases, the arc length increases, as does the demand for arc shielding. For CV welding, the voltage is determined primarily by the machine setting, so the arc length is relatively fixed in CV welding. For SMAW on CC systems, the arc voltage is determined by the arc length, which is manipulated by the welder. As arc lengths are increased with SMAW, the arc voltage will increase, and the amperage will decrease. Arc voltage also controls the width of the weld bead, with higher voltages generating wider beads. Arc voltage has a direct effect on the heat input computation.

The voltage in a welding circuit is not constant, but is composed of a series of voltage drops. Consider the following example: assume the power source delivers a total system voltage of 40 volts. Between the power source and the welding head or gun, there is a voltage drop of perhaps 3 volts associated with the input cable resistance. From the point of attachment of the work lead to the power source work terminal, there is an additional voltage drop of, say, 7 volts. Subtracting the 3 volts and the

7 volts from the original 40, this leaves 30 volts for the arc. This example illustrates how important it is to ensure that the voltages used for monitoring welding procedures properly recognize any losses in the welding circuit. The most accurate way to determine arc voltage is to measure the voltage drop between the contact tip and the work piece. This may not be practical for semiautomatic welding, so voltage is typically read from a point on the wire feeder (where the gun and cable connection is made), to the workpiece. For SMAW welding, voltage is not usually monitored, since it is constantly changing and cannot be controlled except by the welder. Skilled welders hold short arc lengths to deliver the best weld quality.

Travel speed, measured in inches per minute, is the rate at which the electrode is moved relative to the joint. All other variables being equal, travel speed has an inverse effect on the size of the weld beads. As the travel speed increases, the weld size will decrease. Extremely low travel speeds may result in reduced penetration, as the arc impinges on a thick layer of molten metal and the weld puddle rolls ahead of the arc. Travel speed is a key variable used in computing heat input; reducing travel speed increases heat input.

Wire feed speed is a measure of the rate at which the electrode is passed through the welding gun and delivered to the arc. Typically measured in inches per minute (ipm) the wire feed speed is directly proportional to deposition rate, and directly related to amperage. When all other welding conditions are maintained constant (e.g., the same electrode type, diameter, electrode extension, arc voltage, and electrode extension), an increase in wire feed speed will directly lead to an increase in amperage. For slower wire feed speeds, the ratio of wire feed speed to amperage is relatively constant and linear.

For higher levels of wire feed speed, it is possible to increase the wire feed speed at a disproportionately high rate compared to the increase in amperage. When these conditions exist, the deposition rate per amp increases, but at the expense of penetration.

Wire feed speed is the preferred method of maintaining welding procedures for constant voltage wire feed processes. The wire feed speed can be independently adjusted, and measured directly, regardless of the other welding conditions. It is possible to utilize amperage as an alternative to wire feed speed although the resultant amperage for a given wire feed speed may vary, depend-

ing on the polarity, electrode diameter, electrode type, and electrode extension. Although equipment has been available for twenty years that monitors wire feed speed, many codes such as AWS D1.1 continue to acknowledge amperage as the primary method for procedure documentation. D1.1 does permit the use of wire feed speed control instead of amperage, providing a wire feed speed amperage relationship chart is available for comparison. Specification sheets for various Lincoln electrodes provide data that report these relationships.

Electrode extension, also known as “stickout,” or ESO, is the distance from the contact tip to the end of the electrode. It applies only to the wire fed processes. As the electrode extension is increased in a constant voltage system, the electrical resistance of the electrode increases, causing the electrode to be heated. This is known as resistance heating or “I²R heating.” As the amount of heating increases, the arc energy required to melt the electrode decreases. Longer electrode extensions may be employed to gain higher deposition rates at a given amperage. When the electrode extension is increased without any change in wire feed speed, the amperage will decrease. This results in less penetration and less admixture. With the increase in electrode stickout, it is common to increase the machine voltage setting to compensate for the greater voltage drop across the electrode.

In constant voltage systems, it is possible to simultaneously increase the electrode stickout and wire feed speed in a balanced manner so that the current remains constant. When this is done, higher deposition rates are attained. Other welding variables such as voltage and travel speed must be adjusted to maintain a stable arc and to ensure quality welding. The ESO variable should always be within the range recommended by the manufacturer.

Electrode diameter — Larger electrodes can carry higher welding currents. For a fixed amperage, however, smaller electrodes result in higher deposition rates. This is because of the effect on current density discussed below.

Polarity is a definition of the direction of current flow. Positive polarity (reverse) is achieved when the electrode lead is connected to the positive terminal of the direct current (DC) power supply. The work lead is connected to the negative terminal. Negative polarity (straight) occurs when the electrode is connected to the negative

terminal and the work lead to the positive terminal. Alternating current (AC) is not a polarity, but a current type. With AC, the electrode is alternately positive and negative. Submerged arc is the only process that commonly uses either electrode positive or electrode negative polarity for the same type of electrode. AC may also be used. For a fixed wire feed speed, a submerged arc electrode will require more amperage on positive polarity than on negative. For a fixed amperage, it is possible to utilize higher wire feed speeds and deposition rates with negative polarity than with positive. AC exhibits a mix of both positive and negative polarity characteristics. The magnetic field that surrounds any DC conductor can cause a phenomenon known as arc blow, where the arc is physically deflected by the field. The strength of the magnetic field is proportional to the square of the current value, so this is a more significant potential problem with higher currents. AC is less prone to arc blow, and can sometimes be used to overcome this phenomenon.

Heat input is proportional to the welding amperage, times the arc voltage, divided by the travel speed. Higher heat inputs relate to larger weld cross sectional areas, and larger heat affected zones, which may negatively affect mechanical properties in that region. Higher heat input usually results in slightly decreased yield and tensile strength in the weld metal, and generally lower notch toughness because of the interaction of bead size and heat input.

Current density is determined by dividing the welding amperage by the cross sectional area of the electrode. For solid electrodes, the current density is therefore proportional to I/d^2 . For tubular electrodes where current is conducted by the sheath, the current density is related to the area of the metallic cross section. As the current density increases, there will be an increase in deposition rates, as well as penetration. The latter will increase the amount of admixture for a given joint. Notice that this may be accomplished by either increasing the amperage or decreasing the electrode size. Because the electrode diameter is a squared function, a small decrease in diameter may have a significant effect on deposition rates and plate penetration.

Preheat and interpass temperature are used to control cracking tendencies, typically in the base materials. Regarding weld metal properties, for most carbon-manganese-silicon systems, a moderate interpass temperature promotes good notch toughness. Preheat and interpass temperatures greater than 550°F may negatively affect

notch toughness (AWS Position Statement, p. 7). When the base metal receives little or no preheat, the resultant rapid cooling may also lead to a deterioration of notch toughness. Therefore, careful control of preheat and interpass temperatures is critical.

5.2 Purpose of Welding Procedure Specifications

The particular values for the variables discussed in 5.1 have a significant effect on weld soundness, mechanical properties, and productivity. It is therefore critical that those procedural values used in the actual fabrication and erection be appropriate for the specific requirements of the applicable code and job specifications. Welds that will be architecturally exposed, for example, should be made with procedures that minimize spatter, encourage exceptional surface finish, and have limited or no undercut. Welds that will be covered with fireproofing, in contrast, would naturally have less restrictive cosmetic requirements.

Many issues must be considered when selecting welding procedure values. While all welds must have fusion to ensure their strength, the required level of penetration is a function of the joint design and the weld type. All welds are required to deliver a certain yield and/or tensile strength, although the exact level required is a function of the connection design. Not all welds are required to deliver minimum specified levels of notch toughness. Acceptable levels of undercut and porosity are a function of the type of loading applied to the weld. Determination of the most efficient means by which these conditions can be met cannot be left to the welders, but is determined by knowledgeable welding technicians and engineers who create written Welding Procedure Specifications (WPSs) and communicate those requirements to welders by the means of these documents. The WPS is the primary tool that is used to communicate to the welder, supervisor, and the inspector how a specific weld is to be made. The suitability of a weld made by a skilled welder in conformance with the requirements of a WPS can only be as good as the WPS itself. The proper selection of procedural variable values must be achieved in order to have a WPS appropriate for the application. This is the job of the welding expert who generates or writes the WPS. The welder is generally expected to be able to follow the WPS, although the welder may not know how or why each particular variable was selected. Welders are expected to ensure welding is performed in accordance with the WPS. Inspectors do not develop WPSs, but should ensure that they are available and are followed.

The D1.1-96 Structural Welding Code - Steel requires written welding procedures for all fabrication performed (D1.1-96, paragraph 5.5). The inspector is obligated to review the WPSs and to make certain that production welding parameters conform to the requirements of the code (D1.1-96, paragraph 6.3.1). These WPSs are required to be written, regardless of whether they are prequalified or qualified by test (sections 5.3 and 5.5). Each fabricator or erector is responsible for the development of WPSs (D1.1-96, paragraph 4.1.1.1, 4.6). Confusion on this issue apparently still exists since there continue to be reports of fabrication being performed in the absence of written welding procedure specifications. One prevalent misconception is that if the actual parameters under which welding will be performed meet all the conditions for “prequalified” status, written WPSs are not required. This is not true. As has been shown in the cited code references, the requirement is clear.

The WPS is a communication tool, and it is the primary means of communication to all the parties involved regarding how the welding is to be performed. It must therefore be readily available to foremen, inspectors and the welders.

The code is not prescriptive in its requirements regarding the availability and distribution of WPSs. Some shop fabricators have issued each welder employed in their organization with a set of welding procedures that are typically retained in the welder’s locker or tool box. Others have listed WPS parameters on shop drawings. Some company bulletin boards have listings of typical WPSs used in the organization. The AWS D1. Position Statement suggest that WPSs should be posted near the point where welding is being performed. Regardless of the method used, WPSs must be available to those authorized to use them.

It is in the contractor’s best interest to ensure efficient communication with all parties involved. Not only can quality be compromised when WPSs are not available, but productivity can suffer as well. Regarding quality, the limits of suitable operation of the particular welding process and electrode for the steel, joint design and position of welding must be understood. It is obvious that the particular electrode employed must be operated on the proper polarity, that proper shielding gases are used, that amperage levels be appropriate for the diameter of electrode, and appropriate for the thickness of material on which welding is performed. Other issues may not be so obviously apparent. The required preheat for a particular

application is a function of the grade(s) of steel involved, the thickness(es) of material, and the type of electrode employed (whether low hydrogen or non-low hydrogen). The required preheat level can all be communicated by means of the written WPS.

Lack of conformance with the parameters outlined in the WPS may result in the deposition of a weld that does not meet the quality requirements imposed by the code or the job specifications. When an unacceptable weld is made, the corrective measures to be taken may necessitate weld removal and replacement, an activity that routinely increases the cost of that particular weld tenfold. Avoiding these types of unnecessary activities by clear communication has obvious quality and economic ramifications.

Equipment such as Lincoln Electric’s LN-9 wire feeder, which has the ability to have preset welding parameters, coupled with a digital LED display that indicates operational parameters, can assist in maintaining and monitoring WPS parameters. Analog meters can be used on other wire feeders.

The code imposes minimum requirements for a given project. Additional requirements may be imposed by contract specifications. The same would hold true regarding WPS values. Compliance with the minimum requirements of the code may not be adequate under all circumstances. Additional requirements can be communicated through the WPS. For example, the D1.1-96 code permits the use of an E71T-11 FCAW electrode for multiple pass welding without any restriction on plate thickness. The Lincoln Electric product, Innershield NR211MP, has a maximum thickness restriction imposed by the manufacturer of 1/2 in. This additional requirement can be incorporated into the applicable WPS. Other recommendations that may be imposed by the steel producer, electrode manufacturer, or others can and should be documented in the WPS.

5.3 Prequalified Welding Procedure Specifications

The AWS D1.1 code provides for the use of prequalified WPSs. Prequalified WPSs are those that the AWS D1 Committee has determined to have a history of acceptable performance, and so they are not subject to the qualification testing imposed on all other welding procedures. The use of prequalified WPSs does not preclude their need to be in a written format. The use of prequalified WPSs still requires that the welders be appropriately qualified. All

the workmanship provisions imposed in the fabrication section of the code apply to prequalified WPSs. The only code requirement exempted by prequalification is the nondestructive testing and mechanical testing required for qualification of welding procedures.

A host of restrictions and limitations imposed on prequalified welding procedures do not apply to welding procedures that are qualified by test. Prequalified welding procedures must conform with all the prequalified requirements in the code. Failure to comply with a single prequalified condition eliminates the opportunity for the welding procedure to be prequalified (D1.1-96, paragraph 3.1).

The use of a prequalified welding procedure does not exempt the engineer from exercising engineering judgment to determine the suitability of the particular procedure for the specific application (D1.1-96, paragraph 3.1).

In order for a WPS to be prequalified, the following conditions must be met:

- The welding process must be prequalified. Only SMAW, SAW, GMAW (except GMAW-s), and FCAW may be prequalified (D1.1-96, paragraph 3.2.1).
- The base metal/filler metal combination must be prequalified. Prequalified base metals, filler metals, and combinations are shown in D1.1-96, paragraph 3.3, Table 3.1.
- The minimum preheat and interpass temperatures prescribed in D1.1-96, paragraph 3.3, Table 3.2 must be employed (D1.1-96, paragraph 3.5).
- Specific requirements for the various weld types must be maintained. Fillet welds must be in accordance with D1.1-96, paragraph 3.9, plug and slot welds in accordance with D1.1-96, paragraph 3.10, and groove welds in accordance with D1.1-96, paragraphs 3.11, 3.12, and 3.13, as applicable. For the groove welds, whether partial joint penetration or complete joint penetration, the required groove preparation dimensions are shown in D1.1-96, Figures 3.3 and 3.4.

Even if prequalified joint details are employed, the welding procedure must be qualified by test if other prequalified conditions are not met. For example, if a prequalified detail is used on an unlisted steel, the welding procedures must be qualified by test.

Prequalified status requires conformance to a variety of procedural parameters. These are largely contained in D1.1-96, Table 3.7, and include maximum electrode diameters, maximum welding current, maximum root pass thickness, maximum fill pass thicknesses, maximum single-pass fillet weld sizes, and maximum single pass weld layers (D1.1-96, Table 3.3).

In addition to all the preceding requirements, welding performed with a prequalified WPS must be in conformance with the other code provisions contained in the fabrication section of AWS D1.1-96 Structural Welding Code.

The code does not imply that a prequalified WPS will automatically achieve the quality conditions required by the code. It is the contractor's responsibility to ensure that the particular parameters selected within the requirements of the prequalified WPS are suitable for the specific application. An extreme example will serve as an illustration. Consider a (hypothetical) proposed WPS for making a 1/4 in. fillet weld on 3/8 in. A36 steel in the flat position. The weld type and steel are prequalified. SAW, a prequalified process, is selected. The filler metal selected is F7A2-EM12K, meeting the requirements of D1.1-96, Table 3.1. No preheat is specified since it would not be required according to D1.1-96, Table 3.2. The electrode diameter selected is 3/32 in., less than the 1/4 in. maximum specified in D1.1-96, Table 3.7. The maximum single pass fillet weld size in the flat position, according to D1.1-96, Table 3.7, is unlimited, so the 1/4 in. fillet size can be prequalified. The current level selected for making this particular fillet weld is 800 amps, less than the 1000 amp maximum specified in D1.1-96, Table 3.7.

However, the amperage level imposed on the electrode diameter for the thickness of steel on which the weld is being made is inappropriate. It would not meet the requirements of D1.1-96, paragraph 5.3.1.2, which requires that the size of electrode and amperage be suitable for the thickness of material being welded. This illustration demonstrates the fact that compliance with all prequalified conditions does not guarantee that the combination of selected variables will always generate an acceptable weld.

Most contractors will determine preliminary values for a prequalified WPS based upon their experience, recommendations from publications such as Lincoln Electric's *Procedure Handbook of Arc Welding*, the AWS *Welding*

Handbooks, AWS Welding Procedures Specifications (AWS B2.1), or other sources. It is the responsibility of the contractor to verify the suitability of the suggested parameters prior to applying the actual procedure on a project, although the verification test need not be subject to the full range of procedure qualification tests imposed by the code. Typical tests will be made to determine soundness of the weld deposit (e.g., fusion, tie-in of weld beads, freedom from slag inclusions, etc.). The plate could be nondestructively tested or, as is more commonly done, cut, polished, and etched. The latter operations allow for examination of penetration patterns, bead shapes, and tie-in. Welds that are made with prequalified WPSs meeting the physical dimensional requirements (fillet weld size, maximum reinforcement levels, and surface profile requirements), and that are sound (that is, adequate fusion, tie-in and freedom from excessive slag characterized by inclusions and porosity) should meet the strength and ductility requirements imposed by the code for welding procedures qualified by test. Weld soundness, however, cannot be automatically assumed just because the WPS is prequalified.

5.4 Guidelines For Preparing Prequalified WPSs

When developing prequalified WPSs, the starting point is a set of welding parameters appropriate for the general application being considered. Parameters for overhead welding will naturally vary from those required for down-hand welding. The thickness of the material involved will dictate electrode sizes and corresponding current levels. The specific filler metals selected will reflect the strength requirements of the connection. Many other issues must be considered.

Depending on the level of familiarity and comfort the contractor has with the particular values selected, welding a mock-up may be appropriate. Once the parameters that are desired for use in production are established, it is essential to check each of the applicable parameters for compliance with the D1.1-96 code.

To assist in this effort, Annex H has been provided in the D1.1-96 code. This contains a check list that identifies prequalified requirements. If any single parameter deviates from these requirements, the contractor is left with two options: (1) the preliminary procedure can be adjusted to conform with the prequalified constraints; or, (2) the WPS can be qualified by test. If the preliminary procedure is adjusted, it may be appropriate to reexamine its viability by another mock-up.

The next step is to document, in writing, the prequalified WPS values. A sample form is included in Annex E of the code. The fabricator may utilize any convenient format (D1.1-96, paragraph 3.6). Also contained in Annex E are a series of examples of completed WPSs that may be used as a pattern.

5.5 Qualifying Welding Procedures By Test

Conducting qualification tests — There are two primary reasons why welding procedures may be qualified by test. First, it may be a contractual requirement. Secondly, one or more of the specific conditions to be used in production may deviate from the prequalified requirements. In either case, a test weld must be made prior to the establishment of the final WPS. The first step in qualifying a welding procedure by test is to establish the precise parameters to be qualified. The same sources cited for the prequalified WPS starting points could be used for WPSs qualified by test. These will typically be the parameters used for fabrication of the test plate, although this is not always the case, as will be discussed later. In the simplest case, the exact conditions that will be encountered in production will be replicated in the procedure qualification test. These would include the welding process, filler metal, grade of steel, joint details, thicknesses of material, minimum preheat temperature, interpass temperature, and the various welding parameters of amperage, voltage, and travel speed. The initial parameters used to make the procedure qualification test plate beg for a name to define them, although there is no standard industry term. It has been suggested that “TWPS” be used where the “T” could alternately be used for temporary, test, or trial. In any case, it would define the parameters to be used for making the test plate since the validity of the particular parameters cannot be verified until successfully passing the required test. The parameters for the test weld are recorded on a Procedure Qualification Record (PQR). The actual values used should be recorded on this document. The target voltage, for example, may be 30 volts whereas, in actual fact, only 29 volts were used for making the test plate. The 29 volts would be recorded.

After the test plate has been welded, it is allowed to cool and the plate is subjected to the visual and nondestructive testing prescribed by the code. The specific tests required are a function of the type of weld being made and the particular welding consumables. The types of qualification tests are described in D1.1-96, paragraph 4.4.

In order to be acceptable, the test plates must first pass visual inspection followed by nondestructive testing (NDT) (D1.1-96, paragraphs 4.8.1, 4.8.2). At the contractor's option, either RT or UT can be used for NDT. The mechanical tests required involve bend tests (for soundness), macro etch tests (for soundness), and reduced section tensile tests (for strength). For qualification of procedures on steels with significantly different mechanical properties, a longitudinal bend specimen is possible (D1.1-96, paragraph 4.8.3.2). All weld metal tensile tests are required for unlisted filler metals. The nature of the bend specimens, whether side, face, or root, is a function of the thickness of the steel involved. The number and type of tests required are defined in D1.1-96, Table 4.2 for complete joint penetration groove welds, D1.1-96, Table 4.3 for partial joint penetration groove welds, and D1.1-96, Table 4.4 for fillet welds.

Once the number of tests has been determined, the test plate is sectioned and the specimens machined for testing. The results of the tests are recorded on the PQR. According to D1.1-96, if the test results meet all the prescribed requirements, the testing is successful and welding procedures can be established based upon the successful PQR. If the test results are unsuccessful, the PQR cannot be used to establish the WPS. If any one specimen of those tested fails to meet the test requirements, two retests of that particular type of test may be performed with specimens extracted from the same test plate. If both of the supplemental specimens meet the requirements, the D1.1-96 allows the tests to be deemed successful. If the test plate is over 1-1/2 in. thick, failure of a specimen necessitates retesting of all the specimens at the same time from two additional locations in the test material (D1.1-96, paragraph 4.8.5).

It is wise to retain the PQR's from unsuccessful tests, as they may be valuable in the future when another similar welding procedure is contemplated for testing.

The acceptance criteria for the various tests are prescribed in the code. The reduced section tensile tests are required to exceed the minimum specified tensile strength of the steel being joined (D1.1-96, paragraph 4.8.3.5). Specific limits on the size, location, distribution, and type of indication on bend specimens is prescribed in D1.1-96, paragraph 4.8.3.3.

Writing WPSs from successful PQR's — When a PQR records the successful completion of the required tests, welding procedures may be written from that PQR. At a minimum, the values used for the test weld will constitute a valid WPS. The values recorded on the PQR are simply transcribed to a separate form, now known as a WPS rather than a PQR.

It is possible to write more than one WPS from a successful PQR. Welding procedures that are sufficiently similar to those tested can be supported by the same PQR. Significant deviations from those conditions, however, necessitate additional qualification testing. Changes that are considered significant enough to warrant additional testing are considered essential variables, and these are listed in D1.1-96, Tables 4.5, 4.6, and 4.7. For example, consider an SMAW welding procedure that is qualified by test using an E8018-C3 electrode. From that test, it would be possible to write a WPS that utilizes E7018 (since this is a decrease in electrode strength) but it would not be permissible to write a WPS that utilizes E9018-G electrode (because Table 4.5 lists an increase in filler metal classification strength as an essential variable). It is important to carefully review the essential variables in order to determine whether a previously conducted test may be used to substantiate the new procedure being contemplated.

D1.1-96, Table 4.1 defines the range of weld types and positions qualified by various tests. This table is best used not as an "after-the-fact" evaluation of the extent of applicability of the test already conducted, but rather for planning qualification tests. For example, a test plate conducted in the 2G position qualifies the WPS for use in either the 1G or 2G position. Even though the first anticipated use of the WPS may be for the 1G position, it may be advisable to qualify in the 2G position so that additional usage can be obtained from this test plate.

In a similar way, D1.1-96, Table 4.7 defines what changes can be made in the base metals used in production vs. qualification testing. An alternate steel may be selected for the qualification testing simply because it affords additional flexibility for future applications.

If WPS qualification is performed on a non-prequalified joint geometry, and acceptable test results are obtained, WPSs may be written from that PQR utilizing any of the prequalified joint geometries (D1.1-96, Table 4.5, Item 32).

5.6 Examples

To provide some insight into the thought process that a welding engineer may follow to develop a WPS, two examples will be given. In both cases, the weld is the same, namely, a 5/16 in. fillet weld. The specific application conditions, however, will necessitate that a separate WPS be developed for each situation. A sample WPS is included for each situation.

Situation One: The weld to be made is a 5/16 in. fillet weld that connects the shear tab to the column. This weld will be made in the fabrication shop with a column in the horizontal position. The fillet weld is applied to either side of a 1/2 in. shear tab. It is welded to a W14 X 311 column with a flange thickness of 2-1/4 inches. The shear tab is made of A36 steel, while the column is of A572 Gr 50.

The welding engineer recognizes that for the grades of steel involved, and for the type of weld specified, a prequalified WPS could be written. The process of choice for this particular shop fabricator is gas shielded flux cored arc welding, a prequalified welding process. From Table 3.1 of the D1.1-96 code, a list of prequalified filler metals is given. Outershield 70, an E70T-1 electrode, is selected because, for semiautomatic welding, it is likely to be the most economical welding process considering deposition rate and cleanup time. The electrode operates on DC+ polarity. From experience, the engineer knows that a 3/32 in. diameter is appropriate for the application, and specifies that the shielding gas should be CO₂ based upon the electrode manufacturer's recommendation and its low cost characteristics. From Table 3.2 of the D1.1-96 code, the preheat is selected. It is controlled by the thicker steel, that is, the column flange, and required to be a minimum of 150°F since the column flange thickness is 2-1/4 inches. From recommendations supplied by the electrode manufacturer, the welding engineer selects a welding current of 460 amps, 31 volts, and specifies that the welding speed should be 15-17 inches per minute. The final variable is determined based upon experience. If any doubts still exist, a simple fillet weld test could be made to verify the travel speed for the given amperage.

As a quick check, the engineer reviews Annex H to ensure that all the prequalified conditions have been achieved. Finally, these are tabulated on the WPS (see Figure 5-1 for an example of a WPS). The particular form used was a copy from the D1.1-96 code, although

any convenient format could have been used, provided all the required information was given.

Situation Two: The second weld to be made is also a 5/16 in. fillet weld, but in this case, the weld will be made in the field. The weld will be made between the shear tab described above, and the beam web. In this situation, the beam is a W36 X 150, specified to be of A36 steel. Under field conditions, the weld must be made in the vertical position.

The welding engineer again recognizes that the WPS for this application could be prequalified if all the applicable conditions are met. Self shielded flux cored arc welding is selected in order to ensure high quality welds under windy conditions. This is a prequalified process. In D1.1-96, Table 3.1, the engineer locates suitable filler metals and selects Innershield NR232, an E71T-8 self-shielded flux cored electrode which operates on DC negative polarity. Because the welding will be made in the vertical position, a 0.068 in. diameter electrode is specified. From technical literature supplied by Lincoln Electric, a middle-of-the-range procedure suitable for vertical position welding is selected. The engineer specifies the current to be 250 amps, 19-21 volts, with a travel speed of 5.5-6.5 inches per minute. The controlling variable is the thickness of the beam web, which is 5/8 in. In this situation, Table 3.2 of the D1.1-96 code does not require any minimum preheat. These parameters are recorded on the WPS form shown in Figure 5-2.

The two welds to be made are remarkably similar, and yet the WPS values specified are significantly different. In order to ensure that quality welds are delivered at economical rates, it is imperative that a knowledgeable individual establish WPS values. These values must be adhered to during fabrication and erection in order to ensure quality welds in the final structure.

5.7 Approval of WPSs

After a WPS is developed by the fabricator or erector, D1.1 requires that it be reviewed. For prequalified WPSs, the inspector is required to review the WPSs to ensure that they meet all the prequalified requirements (AWS D1.1-96, paragraph 6.3.1). The code requires WPSs qualified by test to be submitted to the engineer for review (D1.1-96, paragraph 4.1.1).

The apparent logic behind the differences in approval procedures is that while prequalified WPSs are based

upon well established, time proven, and documented welding practices, WPSs that have been qualified by test are not automatically subject to such restrictions. Even though the required qualification tests have demonstrated the adequacy of the particular procedure under test conditions, further scrutiny by the engineer is justified to ensure that it is applicable for the particular situation that will be encountered in production.

In practice, it is common for the engineer to delegate the approval activity of all WPSs to the inspector. There is a practical justification for such activity: the engineer may have a more limited understanding of welding engineering, and the inspector may be more qualified for this function. While this practice may be acceptable for typical projects that utilize common materials, more scrutiny is justified for unusual applications that utilize materials in ways that deviate significantly from normal practice. In such situations, it is advisable for the engineer to retain the services of a welding expert to evaluate the suitability of the WPSs for the specific application.

6 Fabrication and Erection Guidelines

6.1 Fit-Up and Assembly

It is important that proper dimensional tolerances be maintained in fabrication. The code prescribes “as detailed” tolerances that apply to variations that can be taken from the prequalified dimensions (D1.1-96, Figures 3.3, 3.4). These dimensions must be shown on shop drawings, but allow the contractor to deviate from the prescribed dimensions within the allowable limits. If from experience, for example, a contractor realizes that a larger root opening is favorable for obtaining the required root penetration, an increase can be made within the limit shown and the geometry is still considered prequalified. “As fit” tolerances apply to the shop drawing dimensions, which may have been increased by the “as detailed” tolerance added to the geometries prescribed for the prequalified joint. For joints that are qualified by test, D1.1-96, Figure 5.3 contains tolerance limitations.

It is particularly important that adequate access to the root of groove welds is provided. Narrow root openings and tight included angles make it more difficult to obtain uniform fusion in the root. Excessively tight root geometries encourage improper width-to-depth ratios that may promote centerline cracking in the weld bead. A width-to-depth ratio of 1.2:1 is generally adequate to prevent centerline cracking.

Excessively wide included angles and root openings waste weld metal, and increase the degree of shrinkage that will occur in the connection, resulting in an increase in distortion and/or residual stress. When the root openings are greater than those permitted, but not greater than twice the thickness of the thinner part or 3/4 in., whichever is less, correction may be made by “buttering” the surface of the short member prior to the members being joined by welding. If welding is performed on only one member at a time, the weld beads are free to shrink on the surface without significantly adding to residual stresses or distortion (D1.1-96, paragraph 5.22.4.3). Greater corrections than these require the approval of the engineer (D1.1-96, paragraph 5.22.4.4).

For joints receiving fillet welds, the parts are to be brought as closely into contact as practicable. If the root opening is greater than 1/16 in., the leg of the fillet weld is required to be increased by the amount of the root opening. The root opening is not allowed to exceed 3/16 in. except in cases involving shapes or plates greater than 3 inches in thickness, in which case a maximum allowable gap of 5/16 in. is permitted, providing backing is used in the joint. Greater dimensions require build-up of the surfaces to reduce the gap (D1.1-96, paragraph 5.22.1).

6.2 Backing and Weld Tabs

Steel backing that will become part of the final structure (i.e., left in place), is required to be continuous for the length of the joint (D1.1-96, paragraph 5.10.2). Thorough fusion between the weld and the backing is required (D1.1-96, paragraph 5.10.1). Suggested backing thicknesses to prevent burn through are shown in D1.1-96, paragraph 5.10.3. For statically loaded structures, D1.1-96 allows the backing to be left in place, and attaching welds need not be full length, unless otherwise specified by the engineer (paragraph 5.10.5). For cyclically loaded structures, steel backing in welds that are transverse to the direction of computed stress are required to be removed, while backing on welds that are parallel to the direction of stress is not required to be removed (D1.1-96, paragraph 5.10.4). For structures designed to resist seismic loading, post-Northridge specifications have often called for the removal of backing from the bottom beam-to-column connection in Special Moment Resisting Frames (SMRF). (AWS Position Statement, p. 5; SAC References p. 6-5, 18, 9-7, 11-6) Contract documents should be carefully reviewed to ensure conformance with any special requirements

regarding backing removal from other locations of the structure such as the top flange connection, continuity plates, etc.

It is generally advisable to tack weld the backing to the joint inside the joint, where the tack welds can be incorporated into the final weld, although this is not a code requirement. D1.1-96, paragraph 5.18.2.2, requires the removal of any tack welds that are not incorporated into the final weld, except for statically loaded structures, unless required by the engineer. Definitive requirements for structures subject to seismic loading have not been established at this point. The code does require, however, that tack welds meet the same quality requirements as final welds with two exceptions: First, preheat is not required for single pass tack welds which are remelted and incorporated into continuous subsequent submerged arc welds, and secondly, discontinuities such as undercut, unfilled craters, and porosity need not be removed before the final submerged arc welding. Notice that both of these deviations are permitted for only applications involving subsequent welding with submerged arc, which is not the common process for many structural applications (D1.1-96, paragraph 5.18.2).

Because of the newer requirements that specify steel backing removal for certain connections in seismic applications, there is renewed interest in **ceramic backing**. This is certainly an option worthy of investigation, although the historic limitations of steel backing still apply. It is essential that the metallurgical compatibility of the ceramic backing and the filler metal being used be established. The self shielded flux cored products are not compatible with all ceramic backing systems. Even when ceramic backing is applied, it is still advisable to back gouge or grind the root of the joint from the back side in order to ensure complete fusion has been gained to the root, and then follow this operation with the application of a reinforcing fillet weld. The D1.1-96 code does not allow for the use of ceramic backing for pre-qualified WPSs, so such approaches are subject to qualification testing (paragraph 5.10, Fig. 3.4).

Welds are required to be terminated in a manner that will ensure sound welds for the full length of the joint. To facilitate this, **weld tabs** may be necessary. They are to be aligned in a manner which will provide for an extension of the joint preparation, i.e., a continuation of the basic joint geometry (D1.1-96, paragraph 3.31.1). The use of plates that are perpendicular to the axis of the weld, commonly known as “end dams” do not constitute

weld tabs (AWS Position Statement p. 5). For statically loaded structures, weld tabs could be left in place while for cyclically loaded structures, they are removed (D1.1-96, paragraphs 5.31.2, 5.31.3). In structures designed to resist seismic loads, weld tabs should be removed from critical beam-to-column connections (AWS Position Statement p. 6; SAC References p. 6-4, 18, 20, 9-7).

The code does not define the length of weld tabs, but they must be sufficiently long to ensure that the weld is full size for the length of the joint. As a rule of thumb, weld tabs should be at least as long as the thickness of the groove weld. It is advisable that the backing (when used) extend beyond the width of the joint by at least the length of the weld tabs.

Acceptable steels for weld tabs and backing are defined in paragraph 5.2.2 of the D1.1-96 code. Unacceptable materials would include rebar (sometimes improperly used for weld backing), and the twist-off ends of bolts (sometimes improperly used for weld tabs/end dams).

6.3 Weld Access Holes

Weld access holes serve two important functions in welded structures. First, as their name implies, they have the practical function of providing access to the weld joint. Secondly, the weld access hole prevents the interaction of the residual stress fields of the flange and web. As shown in Figure 6-1, the longitudinal shrinkage of the web and flange weld, as well as the transverse shrinkage of the flange weld would induce 3-dimensional triaxial residual stresses at some point if it were not for the weld access hole. By reducing triaxial stresses, cracking tendencies can be minimized.

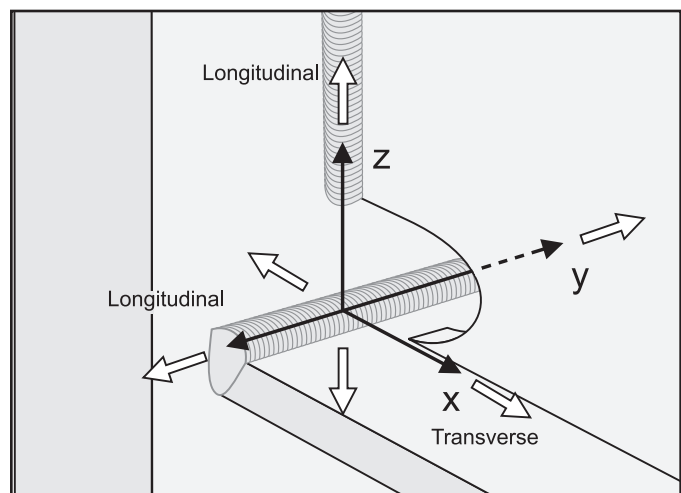

Figure 6-1 Minimization of triaxial stress at the weld access hole

It is important that weld access holes be properly sized and of appropriate quality. Minimum dimensions for weld access holes are prescribed in D1.1-96. The minimum height of the access hole is not to be less than the thickness of the material in which the hole is made, but must be adequate in size for the deposition of sound weld metal. The minimum length of the access hole from the toe of the weld preparation to the end of the radius is 1-1/2 times the thickness of the material in which it is cut. Examples are provided in the code in Figure 5.2.

For heavy Group 4 and 5 rolled shapes, and for built-up sections where the web material thickness is greater than 1-1/2 in., the thermally cut surfaces of weld access holes are to be ground to bright metal and inspected by magnetic particle or dye-penetrant methods (D1.1-96, paragraph 5.17.2). In addition, AISC LRFD M2.2, J1.6 would require that the steel be positively preheated to 150°F prior to the application of the thermal cutting operations. Gouges and nicks in weld access holes can act as stress concentrations and, particularly when subject to seismic loading, can be the point of fracture initiation. Drilling the radius of weld access holes, particularly on heavy members, can assist in the development of high quality surfaces, while eliminating the grinding and subsequent nondestructive testing requirements of the code. It also proves to be a highly cost-effective method, particularly for fabricators with automated drill lines.

6.4 Cutting and Gouging

Back gouging is required for all Complete Joint Penetration (CJP) groove welds made with a prequalified WPS, unless steel backing is used. The resultant cavity created by the back gouging operation is expected to be in substantial conformance with the groove profiles specified for prequalified groove details (D1.1-96, paragraph 5.22.5).

Irregularities in the surface of **thermally-cut edges** may be an indication of inclusions in the steel. These irregularities deserve investigation to preclude the possibility of inducing weld defects that will be determined only after weld completion. Specific acceptance criteria for cut surfaces are contained in paragraph 5.15 of the D1.1-96 code.

6.5 Joint and Weld Cleaning

The surfaces on which weld metal is to be deposited must be conducive to good fusion. Excessive scale, rust and surface contaminants that would inhibit good fusion must be removed. The code provides a practical test to determine excessive levels of scale: mill scale that can withstand rigorous wire brushing may remain (D1.1-96, paragraph 5.15).

The code requires that the slag be removed from all weld passes before subsequent welding. The weld and the adjacent metal are required to be brushed clean. This not only applies to subsequent layers, but also to the crater area of any weld that is interrupted (D1.1-96, paragraph 5.30.1).

Completed welds are required to have the slag removed, and the weld and surrounding base metal cleaned by brushing or other suitable means (D1.1-96, paragraph 5.30.2).

6.6 Preheat and Interpass Temperature

Preheating the steel to be welded will slow the rate at which the heat affected zone and weld metal cool. This may be necessary to avoid cracking of the weld metal or heat affected zone. The need for preheat increases as the steel becomes thicker, the weldment is more highly restrained, the carbon and/or alloy content of the steel increases, or the diffusible hydrogen level of the weld metal increases.

The code requires that the **preheat** used in actual welding be in accordance with the WPS requirements. Preheat is to be measured a minimum of 3 inches away from the joint or through the thickness of the part, whichever is greater (in all directions including the thickness of the part). These are minimum levels of preheat, and these values can be exceeded (D1.1-96, paragraph 5.6). The code does not dictate how preheat is applied, and in most cases, the contractor will use fuel gases as a source of thermal energy, although resistant strip heaters can be used. It is important during the application of preheat that the steel not be heated too rapidly so as to cause hot spots, local distress that would be induced by shrinkage, or in the extreme case, localized melting of the steel surface.

Although preheat can be measured in a variety of ways, the most accurate and practical method is to employ temperature indicating crayons. For some thicknesses and grades of steel, and for select electrodes, there is no need to preheat. This is because, for the specific conditions encountered, the hardenability of the steel is sufficiently low that there is no expected danger of weld cracking. The secondary benefit of preheating, however, is that it dries the joint of moisture that may be on the surface of the steel. The code requires the surfaces to be free of moisture (D1.1-96, paragraph 5.15). Welding is not to be performed when the surfaces are wet or exposed to rain, or snow, or when welding personnel are exposed to inclement conditions (D1.1-96, paragraph 5.12.2). If moisture from condensation, for example, is on the surface of the steel, even though preheat is not required for traditional reasons, it is necessary to dry the steel to ensure quality welding. This could be done with a gas torch, but condensation of water from the flame's products of combustion can actually result in more surface moisture. The use of heated air guns or infrared heaters can eliminate this.

When making beam-to-column connections where jumbo sections (Group 4 and 5 shapes) are used for the column member, it is advisable to increase the preheat level beyond the minimum prequalified level to that required by AISC for making butt splices in jumbo sections, namely 350°F (AISC LRFD J2.8). This conservative recommendation is made acknowledging that the minimum preheat requirements prescribed by the D1.1-96 code for prequalified WPSs may not be adequate for these highly restrained connections.

Interpass temperature refers to the temperature of the steel just prior to the deposition of an additional weld pass. Its effect is identical to preheat temperature, except that preheating is performed prior to any welding. As welding is performed, the temperature of the steel will naturally increase momentarily in the vicinity of the weld due to the introduction of thermal energy from the arc. Immediately thereafter, the surrounding steel begins to draw this heat away, reducing the temperature. If another weld pass is made fairly quickly, the temperature of the steel may be higher than that of the minimum preheat temperature. If a longer period of time exists between weld passes, the steel may have cooled to a temperature below the minimum **interpass temperature** which should be the same as the minimum preheat temperature. Many factors influence this condition in addition to time, including the thickness of the steel, and the amount of

energy added by the welding process. For weldments where the joint has a smaller cross-sectional area, there is a natural tendency for the interpass temperature to increase beyond that of the preheat level. On joints with a large cross-sectional area, just the opposite occurs. For butt splices in flanges, as well as beam flange-to-column connections, it is natural for the interpass temperature to increase to higher levels. Care must be taken not to exceed specified interpass temperatures because excessively high interpass temperatures can result in a deterioration of weld metal and HAZ properties.

The D1.1-96 code does not impose specific maximum interpass temperatures on welding operations, either as a general fabrication requirement or a prequalified constraint. The AWS Position Statement (p. 7), however, has noted this as an area in which the code could be improved, and has suggested that, for joints where notch toughness is required, the maximum interpass temperature for prequalified WPSs be limited to 550°F. Higher interpass temperatures generally result in decreased toughness and lower strength of the weld metal. The AWS Position Statement does not preclude the qualification of a higher maximum and interpass temperature by test. Monitoring a maximum interpass temperature is much like maintaining minimum preheat and interpass temperatures, but obviously a second, high-temperature crayon is required. The typical means by which this is controlled will be simply to not weld on that particular joint until it has cooled to an acceptable temperature. This may necessitate movement to another weld joint.

6.7 Welding Techniques

Regardless of whether a welding procedure is prequalified or is qualified by test, it is essential that these values be maintained for production welding. It is the inspector's responsibility to make certain that the actual welding parameters used conform to the WPS (D1.1-96, paragraph 6.5.2). The code also requires the inspector to periodically observe the welding techniques and the performance of each welder (D1.1-96, paragraph 6.5.4). This is an opportune time to ensure that the actual parameters being used are appropriate. Under Section 5.11, the D1.1-96 code requires that the welding and cutting equipment be designed so as to enable designated personnel to follow the procedures and obtain the results required by the code. This requires that the equipment be in appropriate working condition, and implies that proper metering devices will be available to demonstrate that the correct welding conditions are being maintained.

These meters could be built into the equipment, or alternately could consist of hand held metering devices.

Arc welding processes are inherently dynamic. As a function of time, amperage and voltage are not absolutely constant. A nominal, or average value, is what the code intends to have maintained. A sensitive ammeter, for example, may register swings of several hundred amps from the nominal value. It is not possible, or even desirable, for the electrical values to be absolutely constant. For control of welding parameters, only the average or nominal value is important. Voltage is measured between two points in an electrical circuit. It is important that voltage be read as near the arc as possible. Amperage is the same through an electrical circuit, and can be read at any convenient point.

The most accurate method to control welding parameters for wire feed processes is to use wire feed speeds. In a constant voltage circuit, the amperage is not set by the operator. The power source will deliver the required amperage to maintain the voltage selected by the operator. The required amperage is a function of the wire feed speed, electrode diameter, electrical stickout and electrode polarity. When wire feed speeds are used as needed as the primary variable of control, the resultant amperage can be used to verify that all the other variables are correct. However, when amperage is used as the primary controlling variable, an improper electrical stickout or polarity can go undetected.

Travel speed is one of the more difficult elements to control, particularly for manual and semiautomatic welding. The most direct and practical way to ensure that travel speeds are appropriate is to monitor the relative size of the weld passes being deposited. Since the weld size is inversely proportional to the travel speed, acceptably accurate control of travel speed can be maintained in this manner.

The **root pass** is generally the most critical pass in a weld, and is arguably the most difficult to make. Adequate access to the root must be achieved by proper fit-up of properly prepared joints. As with all welding, it is essential that the operator keep the electrode on the leading edge of the weld pool to ensure that the intense energy of the arc is available to melt the base metal, thus assuring adequate fusion. When the weld pool rolls ahead of the arc, the arc energy is concentrated on the liquid metal of the weld pool instead of the base metal. Lack of fusion and slag inclusions may result.

Excessively slow travel speeds encourage this type of behavior, and welds made with slow travel speeds have inherently larger beads. For this reason, the AWS Position Statement (p. 6) has recommended a maximum root pass thickness of 1/4 in. to encourage root fusion. For all processes except SMAW, the code mandates a maximum 1/4 in. layer thickness for all intermediate weld layers (that is, except the root and the cap pass), but this is more easily achieved because the width of the joint for subsequent layers is larger than in the root pass (D1.1- 96, Table 3.7). For SMAW, the maximum layer thickness is restricted to 3/16 in.

The **bottom beam flange-to-column connection** for beam-to-column assemblies is one of the most difficult welds to make because of the geometric constraints imposed by the presence of the beam web. Weld beads are, of necessity, interrupted in the middle of the length of the weld. Welding must be performed through the weld access hole, adding additional difficulty to the operation. One of two sequence procedures can be employed, as follows:

The following techniques are recommended (adopted from FEMA 267, p. 6-20):

1. The root pass thickness should not exceed 1/4 in.
2. The first half-length root pass should be made with one of the following techniques, at the option of the contractor:
 - a) The root pass may be initiated near the center of the joint. If this approach is used, the welder should extend the electrode through the weld access hole, approximately 1 in. beyond the opposite side of the girder web. This is to allow adequate access for cleaning and inspection of the initiation point of the weld before the second half-length of the root pass is applied. It is not desirable to initiate the arc in the exact center of the girder width, since this will limit access to the start of the weld during post-weld operations. After the arc is initiated, travel should progress towards the end of the joint (that is, toward the beam flange edge), and the weld should be terminated on a weld tab.
 - b) The weld may be initiated on the weld tab, with travel progressing toward the center of the girder flange width. When this approach is used, the welder should stop the weld approximately 1 in. before the beam

web. It is not advisable to leave the weld crater in the center of the beam flange width since this will hinder post-weld operations.

3. The half-length root pass should be thoroughly deslagged and cleaned.
4. The end of the half-length root pass that is near the center of the beam flange should be visually inspected to ensure fusion, soundness, freedom from slag inclusions and excessive porosity. The resulting bead profile should be suitable for obtaining fusion by the subsequent pass to be initiated. If the profile is not conducive to good fusion, the start of the first root pass should be ground, gouged, chipped, or otherwise prepared to ensure adequate fusion.
5. The second half of the weld joint should have the root pass applied before any other weld passes are performed. The arc should be initiated at the end of the half-length root pass that is near the center of the beam flange, and travel should progress to the outer end of the joint, terminating on the weld tab.
6. Each weld layer should be completed on both sides of the joint before a new layer is deposited.

Regardless of the approach used, it is important that the start-and-stop point be carefully determined to provide for adequate cleaning of the previously made half-length weld pass, and to facilitate adequate tie-in of the remaining half-length weld pass.

It is recommended that no additional layer of weld metal be deposited before the previous layer is completed for the full length of the weld joint (AWS Position Statement, p. 8). Notice this does not dictate that the individual beads be completed full length, but rather that the layers be completed full length. The layer-completion approach has been suggested to prohibit the technique that would allow for the completion of an entire half-length of the weld prior to welding on the opposite side of the web. Completing an entire half-length first would commonly result in fusion problems in the center of the length of the weld.

In Annex B of D1.1-96 code, stringer beads are defined as a type of weld bead made without appreciable weaving motion. Weave beads are defined as a type of weld bead made with transverse oscillation. The D1.1 code does not mandate nor restrict stringer passes or weaving.

Final bead widths are not directly prescribed, although the maximum root width is controlled. For prequalified WPSs, the maximum full width weld beads are restricted to joints with a root face of 5/8 in. for FCAW performed in other than the vertical position. For vertical welding, this dimension is increased to 1 in. (D1.1-96, Figure 3.7, footnote 5). It would be possible to increase the maximum width of a weld bead by qualification testing.

A balance must be established between many small stringer passes, and a few larger weave passes. As the number of passes increases, the amount of distortion and the corresponding residual stresses increase. In most cases, however, increased notch toughness is obtained in the weld beads when smaller stringer passes are employed. Either extreme can cause problems. An excessive number of small stringer passes will result in extremely high cooling rates of the weld beads, and a corresponding increase in yield and tensile strength, a decrease in elongation, and perhaps a decrease in notch toughness in the weld deposit. Excessively large weld beads result in a decrease in strength, and a decrease in notch toughness, although the measured elongation may actually increase. Excessively large weld beads are invariably associated with high welding heat input which may have negative effects on the heat affected zone.

Bead size and deposition rate are not directly related although bead size (cross section) and heat input are. It is possible to maintain smaller bead sizes with high deposition rate procedures, providing the travel speed is appropriately adjusted (i.e., increased). For most groove welding procedures, weld passes that deposit the equivalent volume of weld metal as would be required for 1/4 in. to 3/8 in. fillet welds is optimum. This equates to a heat input of approximately 30 to 70 kJ/in. By maintaining the prequalified bead sizes specified in the code (width and thickness), these conditions are generally achieved.

Aside from the cited effect on mechanical properties, the greatest concern associated with excessively wide weld passes is the probability of inducing fusion-related problems and slag inclusions.

It is inappropriate to fully restrict oscillation of the electrode. Skilled welders are aware of the approximate width that the weld bead will assume with a straight, linear progression. When this bead width is inadequate to completely fuse between the sides of groove weld, or between a previous pass in the side of the groove, a slight

oscillation of the electrode not only should be permitted, but is desirable. The AWS D1 Position Statement (p. 6) permits such oscillations, suggests that the oscillation should be within certain limitations, and advises inspectors to monitor final bead widths, not oscillation dimensions.

The D1.1-96 code neither requires nor prohibits **peening**, except for root and cap passes, where peening is prohibited (paragraph 5.27). Peening is not justified for routine fabrication (AWS Position Statement, p. 8). For highly restrained members, and particularly for critical repairs, peening of intermediate weld beads may be helpful in reducing the level of residual stress that is imposed by the shrinkage of the weld beads.

Whenever possible, welders should initiate the arc in the weld joint or on weld tabs, eliminating the possibility of **arc strikes** outside of the weld joint. The D1.1-96 code does not expressly prohibit arc strikes, but advises that they should be avoided. If they occur, they are to be ground to a smooth contour and checked to ensure soundness (D1.1-96, paragraph 5.29). It is important that welding cables be properly insulated to ensure that inadvertent arc strikes are not created in other areas of the structure.

6.8 Special Welding Conditions

Weld repairs — Welds that do not meet the acceptance criteria can be repaired. Repairs fit into three categories: (1) removal of excess metal; (2) deposition of additional metal; and, (3) removal and reapplication of metal. Overlap, excessive convexity, or excessive reinforcement can be addressed by removal of excess metal (D1.1-96, paragraph 5.26.1.1). Excessive concavity, undersized welds, and undercut can be repaired by the application of additional metal (D1.1-96, paragraph 5.26.1.2). Weld metal porosity, incomplete fusion, slag inclusions, and cracks must be repaired by removing the deficient weld metal, and applying sound metal. In the case of cracks, not only must the crack be removed, but sound metal 2 in. beyond the end of the crack must also be removed. The extent of cracking is required to be determined by dye penetrant or magnetic particle inspection, or other means (D1.1-96, paragraph 5.26.1.4). The ends of deep cavities should be cascaded to facilitate quality welds at the ends of the cavity.

Protection for gas shielded processes — For GMAW, FCAW-g, and other gas shielded processes such as GTAW and EGW, it is important that the gas shield not be disturbed by air movement. Tenting of one type or another is generally supplied for field welding, and the code requires that the velocity of any wind be reduced to a maximum of 5 miles per hour (D1.1-96, paragraph 5.12.1). It is important that tenting be of materials that are not flammable, or that welding take place in a location where it does not constitute a fire hazard. Highly effective tenting may not provide adequate ventilation for the welder, another consideration. For these reasons, SMAW and FCAW-ss are the preferred processes for most field welding conditions.

Cold temperature welding — Completely aside from preheat requirements, welding should not be done when welding personnel are exposed to conditions under which quality will suffer. The code prescribes the lower bound for “ambient” temperature to be 0°F. The word “ambient” is emphasized because it is possible to change ambient conditions by tenting, or other enclosures. The outside environmental temperature could drop below 0°F, but if within the shelter the temperature is above this lower limit, welding may continue (D1.1-96, paragraph 5.12.2).

When welding under cold conditions, it is also important to reexamine preheat requirements. For prequalified WPSs, the D1.1 code mandates that, even for situations where no preheat application is required, the temperature of the steel be raised to a minimum of 70°F when the ambient temperature drops below 32°F (D1.1-96, see Footnote 1 to Table 3.2). Although this is restricted to prequalified conditions, it is a good practice for all welding. If extremely low temperature conditions are anticipated and no preheat is going to be applied, the WPS should be qualified by test on plate held at the cold temperature.

6.9 Weld Metal Mechanical Properties

The first important point in any discussion about mechanical properties is to recognize that a weld, like any other material, is not uniform. When a weld bead is deposited, three distinct zones are created — the fusion zone, which is the product of melting welding electrode with some base material, the heat affected zone (HAZ) in the base material which was heated to a temperature high

enough to alter the microstructure and properties without melting, and the zone comprised of the surrounding unaffected base material (see Figure 6-2).

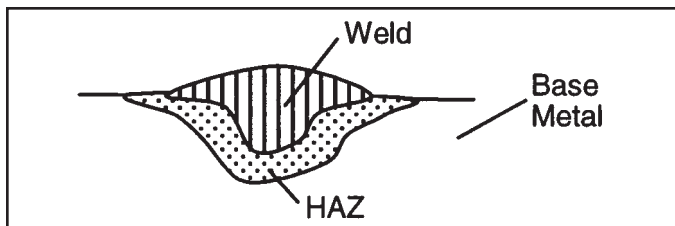

Figure 6-2 Three zones created by welding

This is a somewhat simplified example, but it will illustrate the point. It is reasonable to expect the mechanical properties and the chemical composition to vary across these zones. Chemical composition in the weld bead may be different than that of the electrode composition due to the mixing with the base material. The microstructure variation from the HAZ to the weld metal is always significant, even if the base metal and filler metal chemical compositions are very similar.

Now, consider what happens in a multiple pass weld where several overlapping weld beads are deposited. Each successively deposited bead reheats and refines a narrow zone around it, creating a series of overlapping HAZs both in the base plate and in the weld metal (see Figure 6-3).

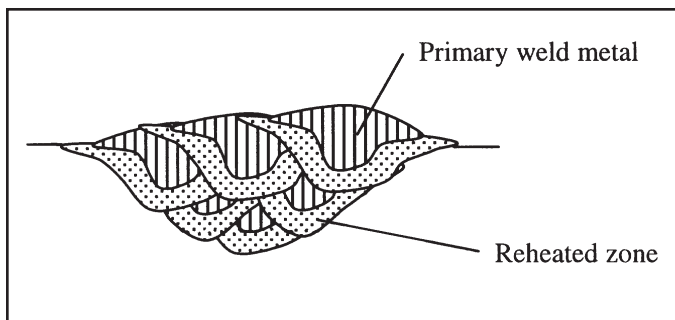

Figure 6-3 Grain refinement in multiple pass weld

The areas of weld metal that are not affected by the heating of subsequent passes are usually referred to as primary weld metal. Consequently, many small zones are closely created in close proximity, which will not necessarily exhibit consistent chemical composition, metallurgical structure or mechanical properties.

Additionally, regions of the weld metal close to the base material may be somewhat different in chemical composition than regions in the middle of the weld near the surface, simply because of dilution. The differences will

depend on how closely the compositions of the weld electrode and base material match. Further, the welding procedures used can significantly change the number and arrangement of these various zones in the weld. If an electrode diameter and/or welding parameters were selected that produced smaller and flatter weld beads, the amount of primary weld metal relative to reheated weld metal would be significantly different (see Figure 6-4). Rarely, if ever, are the mechanical properties of the refined HAZs the same as those of the primary weld metal, even when the chemical composition does not vary significantly. It is, therefore, important to understand the purpose of any test and what is actually being measured, since the results can vary according to the test specimen location and fabrication procedures.

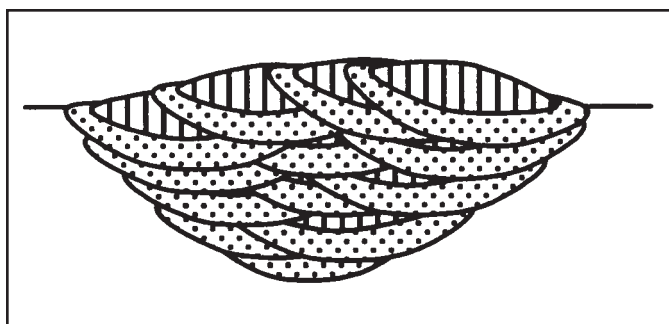

Figure 6-4 Grain refinement for flat weld beads

AWS classification testing — Classification of welding consumables for welding steels often requires mechanical testing, which may include tests for mechanical properties such as ultimate tensile strength, yield strength and Charpy V-notch impact toughness. It is important to note that not all of these tests are required in every case. For example, AWS A5.20-95 specifies the classification requirements for approximately 37 types of FCAW electrodes. All of them have an ultimate tensile strength requirement, but less than half of them have yield strength and/or Charpy V-notch requirements.

In the context of the preceding discussion about inherent variability, the classification test represents a single welding condition for a consumable. As such, the mechanical properties determined for a welding consumable during classification might not be representative of the properties achievable under actual production welding conditions. Consequently, fabricators are cautioned that the AWS classification test results which form the basis for most published literature on welding consumables should be used as a relative guide for consumable selection and not a guarantee that the specified minimum properties will be achieved under actual production welding conditions.

Such differences between classification tests and actual production welding conditions, represented in a procedure qualification test, for example, arise because the mechanical properties achieved in any weld depend as much on the welding and testing procedures as on the welding consumables selected. AWS cautions that the following can influence weld metal mechanical properties: electrode size, current type and polarity, voltage, type and amount of shielding gas, welding position, electrode extension, plate thickness, joint geometry, bead placement, preheat and interpass temperatures, travel speed, base material composition and extent of dilution. It is almost impossible to change one variable without also affecting several others.

Strength — For classification, weld metal strength is typically measured by means of a 0.500 in. diameter specimen located in the weld cross-section as illustrated in Figure 6-5.

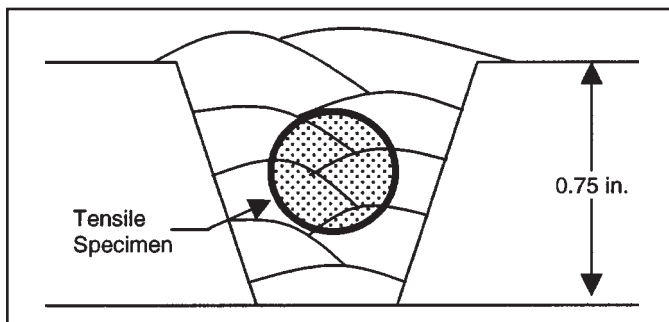

Figure 6-5 Typical tensile specimen location

Strength measured in this way is influenced to a large extent by both the chemical composition of the consumable and the welding procedure. A standard base material type is used and the root opening is wide enough to minimize the effects of dilution at the weld center. Further, the specimen is large enough that it samples both primary and reheated weld metals, making variations between these two zones relatively insignificant. Strength usually fluctuates directly with alloy level. Certain procedure variables can actually influence how much of the alloy in the electrode is transferred to the weld deposit. Some alloy elements (e.g., Mn) are easily oxidized in the arc. Higher arc voltages (i.e., longer arc length) tend to result in lower weld metal alloy levels. With a longer arc length there is more time for oxidation to occur across the arc. This corresponds to a greater loss of alloying elements and lower strength. Conversely, with shorter arc lengths there is less time available for oxidation in the arc atmosphere, resulting in a potential-

ly higher alloy level and higher strength. Therefore, selection of welding voltage and electrode extension will control the arc length and influence the alloy level and strength.

Oxidation which occurs as a result of slag/metal reactions also influences alloy levels. A higher heat input usually results in slower cooling rates. Slower cooling rates lead to longer reaction times and possibly greater loss of alloy due to slag/metal reactions. Conversely, a lower heat input, resulting in a faster cooling rate, may promote higher alloy content.

The cooling rate also influences the weld metal microstructure, which influences strength. Faster cooling rates can promote harder structures, which elevate strength measurements. Slower cooling rates promote softer structures and also contribute to grain coarsening in the reheated regions, both factors that can lower strength measurements. The effect of cooling rate is illustrated graphically in Figure 6-6. The weld metal strength may also differ from an AWS test plate due to the joint geometry.

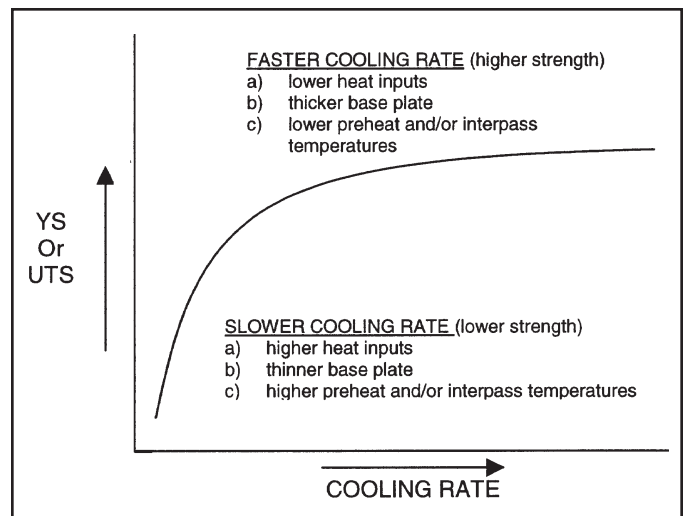

Figure 6-6 Strength related to cooling rate

In a very narrow groove weld, dilution effects from the base material become more of a factor. Also, when the joint volume becomes so small that a smaller diameter tensile specimen is necessary, variations in measurement can occur simply as a result of specimen size.

Tests that vary from the standard AWS classification condition provide useful information about the mechanical performance of the weld metal. However, it is important to remember what is being tested and for what purpose.

Charpy V-notch impact toughness — Charpy V-notch (CVN) impact test results also vary significantly with composition and welding procedure variables, and are dependent on test temperature. A schematic illustration of CVN response with temperature is illustrated in Figure 6-7. At lower test temperatures, a lower shelf exists where the fractures are brittle in appearance and further reductions in test temperature achieve no further substantial reduction in energy. By contrast, at higher test temperatures, an upper shelf is observed where the fractures are ductile in appearance and further increases in test

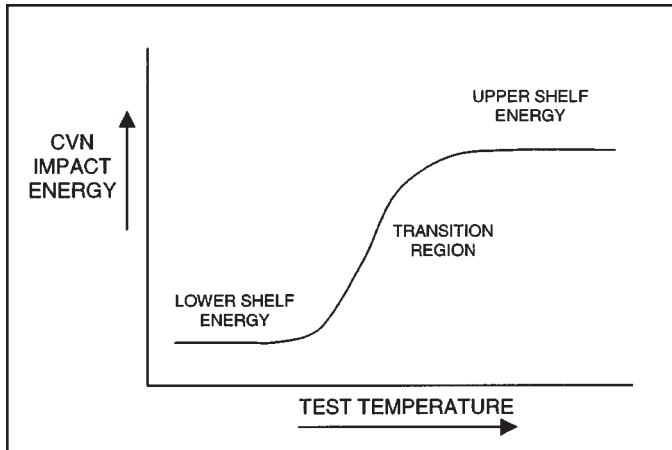

Figure 6-7 Schematic CVN transition curve

temperature achieve no substantial improvement in CVN energy. Between these two shelves is the transition region where the fractures have some ductile and some brittle character. All steel weld metals have these characteristics, although the specific shape and position of the curve relative to temperature depend on the alloy type, fabrication details and the location of the CVN notch in the weld. Variations in chemical composition and welding procedure that influence weld thermal cycles can alter the upper and lower shelf energies as well as the temperature range over which the transition occurs.

For this reason, AWS classification tests are conducted with the CVN located at the mid-thickness on the weld centerline, as shown in Figure 6-8.

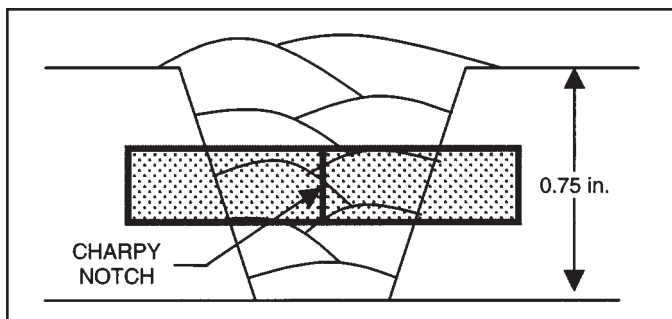

Figure 6-8 Typical CVN specimen location

These tests are conducted at a single test temperature with the results evaluated based on a minimum energy required. In most cases, where CVN specimens are required for classification, the test temperature is in the transition region where test scatter is typically the highest and variations in composition and welding process variables can have a large effect on the impact energy measurements. The specimen is oriented in the groove weld so that variation due to location is minimized. Note that the notch is located on the weld centerline in the bead overlap region where the greatest amount of refinement takes place. While this provides for greater testing consistency, it also samples the region of the weld with potentially the highest impact toughness.

The finer grained material in the reheated regions usually has higher CVN values than columnar structures encountered in the primary weld metal. This is not true in every case. There are a few welding consumables specifically designed to achieve high levels of toughness in the primary weld metal. However, AWS classification tests, which form the basis for most product literature, will not usually make this distinction. Rather, the more usual differences in performance between as-welded and reheated weld metals in the same weld joint can give rise to large differences in apparent CVN performance. For example, a qualification test that samples CVN from the root region of a double V-groove is not likely to achieve the same level of CVN energy reported for AWS classification tests. Such tests are intended to simulate production welding conditions, not differences from AWS classification testing conditions.

CVN performance can be influenced by chemical composition variations in ways that can either increase or decrease CVN energy at a given test temperature. The resulting impact on CVN energy will depend on how the composition variation influences the weld microstructure. If grain refinement can be achieved without other undesirable changes in the structure, CVN energy should increase. However, in most cases, a shift in composition away from the optimum design for the welding consumable has the effect of reducing CVN energy to some degree.

Welding process variables can also influence the CVN test results. For example, higher welding heat inputs and inter-pass temperatures have the effect of slowing the cooling rate as seen in the discussion on strength. This allows more time at elevated temperature, which widens the bands of reheated metallurgical structure, but also promotes a coarser

grain structure in these regions. Consequently, it is impossible to determine which variable(s) will govern performance without specific knowledge of the welding consumable and alloy system. Chemical composition variations that result from dilution can be minimized if welding conditions which minimize penetration are selected.

Variation is an inherent part of a weld, but the extent of variation is influenced both by the materials selected for a particular weldment and the procedure variables chosen for the fabrication. Both affect the mechanical test results obtained with a given welding consumable. Whenever the mechanical properties of a weld are determined by testing, it is important to recognize that such variations exist and can influence the results. Consequently, literature based entirely on AWS classification testing should be used only as a relative guide to weld metal performance. Fabricators and designers with more stringent performance requirements should always consult the electrode manufacturer for additional guidance.

6.10 Intermixing of Weld Deposits

For most arc welding processes, the molten metal is protected from the atmosphere by a combination of shielding and/or a slag system. In this respect, FCAW-ss is unique. FCAW-ss consumables produce very little shielding gas, relying heavily on slag systems. Rather than protecting the molten metal from atmospheric contamination, the slag relies on the addition of large amounts of deoxidizers to react with oxygen and nitrogen. While aluminum is the primary deoxidizer, smaller quantities of titanium and zirconium may also be present. Consequently, aluminum levels in excess of 1% by weight are common, significantly higher than the aluminum contents typically found in steel base materials. Low levels of aluminum in both base metal and weld metal have been known to cause a reduction in toughness, so the higher levels of aluminum found in the weld deposits of FCAW-ss have generated curiosity. Because of its function as a primary deoxidizer/denitrider, aluminum is essential to the metallurgy of the typical FCAW-ss weld deposit. For example, significant quantities of nitrogen may be contained in the weld metal of FCAW-ss, but this nitrogen is in the compound of aluminum nitride (AlN). While the nitrogen content may be 500 ppm, the available 10,000 ppm level of aluminum ensures that there is always excess aluminum to ensure formation of AlN (which requires an Al:N ratio of approximately 2:1). The remaining aluminum therefore acts as an alloying agent in the weld metal.

The balance between aluminum and nitrogen, as well as carbon and other alloying elements, must be properly maintained to ensure the specified mechanical properties are obtained from the weld deposit. As a result of these unique characteristics, many FCAW-ss weld deposits can contain substantially higher carbon (up to 0.45 wt. pct.), lower manganese (as low as 0.5 wt. pct.), lower oxygen (as low as 30 ppm), and significantly higher nitrogen (up to 700 ppm) than would be found in weld metals produced by other arc welding processes. When welding consumables which derive their properties from different metallurgical mechanisms and alloy balances are mixed in a single joint there is the potential for negative interaction. For example, if a root pass is made with FCAW-ss, and the subsequent fill passes are made with SMAW or FCAW-g, the properties of the fill passes may be negatively affected in terms of ductility and notch toughness.

This phenomenon is, at least in part, the result of excess aluminum picked up through dilution from the underlying FCAW-ss weld metal. The SMAW or FCAW-g weld metals, typically manganese-silicon deoxidized metallurgical systems, are not designed to accommodate excess aluminum. The presence of even a small amount of excess aluminum alters the normal deoxidation sequence, which influences the formation of non-metallic inclusions and disrupts the normal alloy balance. Thus, the notch toughness of the manganese-silicon deoxidized weld metal may be significantly reduced by the introduction of small levels of aluminum. The use of multiple weld processes and electrode or consumable types in a single weld joint may occur for several reasons. Tack welding might be performed with one process/electrode, and the completion of the joint made with another. The more demanding welding conditions of root pass welding, and particularly open root joints (i.e., no backing), may dictate a different weld process/electrode for the root pass.

Multiple processes also may result when repair welding is being performed with a different process/electrode than the original method used to fabricate the joint. When intermixing of weld process/electrode types occurs in the same weld joint, the potential for negative effects must be investigated. The use of non-FCAW-ss weld process/electrodes on top of welds made by FCAW-ss is of particular concern. The resulting mechanical properties of subsequent welds will be dependent on many variables, including: the original composition of the FCAW-ss deposit; the degree of admixture (related to penetration) that will occur in the subsequent welding;

and the actual level of mechanical properties delivered by the subsequent weld process when they are unaffected by FCAW-ss interactions. For example, when deep-penetrating SAW is used upon high aluminum content FCAW-ss welds, notch toughness may decrease from a moderate level of 40 ft-lbf. at -20°F to less than 15 ft-lbf at the same temperature. In contrast, a shallow penetrating SMAW weld deposit made with E7018 may find the notch toughness decreases from 150 ft-lbf to 80 ft-lbf at the same temperature, but the resultant notch toughness may be more than adequate for the application.

It has been believed in the past that this concern existed only for non-FCAW-ss weld deposits on top of FCAW-ss. However, tests indicate that reductions in toughness are possible with combinations of other welding processes and electrode types. Two approaches can be taken with respect to this issue. First, the same process can be used throughout, eliminating potential concerns. Secondly, the potential interaction of the two processes can be evaluated by testing. The latter approach is recommended by the SAC Interim Guidelines. A test program was undertaken in order to provide guidance regarding the effects of some admixture combinations on mechanical properties, specifically toughness, and to assess the probable mechanisms at work. Initial interest focused on a case in which a SMAW, FCAW-g or SAW deposit was made over FCAW-ss. The program was expanded to include deposition of FCAW-ss weld metal over SMAW, FCAW-g and SAW. The emphasis was consistently on combinations of welding consumables which derive their properties from significantly different metallurgical mechanisms and alloy balances. The objective in each case was to determine the magnitude of toughness reduction in the fill material resulting from dilution from the root material.

To this end, the joint geometry and bead sequence were selected to achieve a reasonably high level of dilution. A typical joint is illustrated in Figure 6-9. Each combination of fill and root materials was evaluated based on Charpy V-notch impact test specimens located at the maximum dilution location. That is, the bottom of the test specimen was located as closely as possible to the fusion boundary between the fill and root materials, thus maximizing the effect of dilution on the test. Specimen location is illustrated in Figure 6-9.

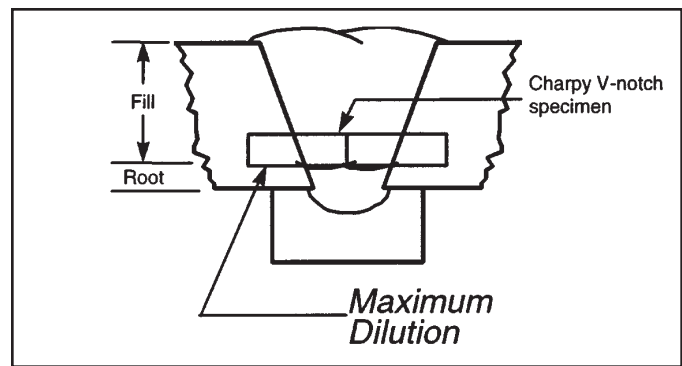

Figure 6-9 Locations of CVN test specimens

All notches were approximately centered between the side walls in the bead overlap regions to be as consistent as possible with standard AWS certification testing. The extent of toughness reduction was determined by comparing the results from each admixture weld with the results from similar locations in test welds fabricated entirely with the fill electrode. So, for example, SMAW diluted with FCAW-ss is compared with the same SMAW from the same general area in the groove without dilution from FCAW-ss.

It is important to note that actual field conditions may be more or less severe than those in the tests represented here. Any reduction in notch toughness will be highly dependent upon the extent of dilution from underlying weld metal. Consequently, variations in welding procedure, joint geometry and configuration will influence results. Further, it should be noted that some reduction in notch toughness may be tolerable for an application, depending upon the specific requirements prevailing. Consequently, the user must be the ultimate judge as to the applicability of specific electrode combinations for a particular field application. While the recommendations provided below are based on conservative tests achieving relatively high levels of dilution, the best test is one which simulates the specific application and welding procedures to be employed. Users are encouraged to conduct their own tests to verify that desired performance is obtained.

Table 6.1 summarizes the recommendations based on test results for some combinations. Some recommendations are based on results expected simply on the basis of chemical composition differences between the consumables. However, most recommendations result from the comparison of a single test weld for each intermixed combination against a corresponding baseline test weld as previously described. The recommendations are

based on satisfying a 20 ft-lbf requirement at either -20°F or 0°F. The combinations have been categorized based on the performance of the fill passes only.

- A No change in notch toughness is expected.
- B Some decrease in notch toughness is anticipated. However, Charpy V-notch exceeding 20 ft-lbf at both -20°F and 0°F is expected.
- C Some decrease in notch toughness is anticipated. However, Charpy V-notch results are expected to exceed 20 ft-lbf at 0°F but not necessarily at -20°F.
- D Significant reductions in notch toughness are anticipated. Charpy V-notch results exceeding 20 ft-lbf are not expected consistently at either -20°F or 0°F.
- E Significant reductions in notch toughness are expected. Charpy V-notch results approaching 20 ft-lbf are not expected at either -20°F or 0°F.

Table 6-1

Root Electrode	Fill Electrode					
	LH70	LH75	OS70	NR232	NR305	NR311Ni
NR305	C	C	E	A	-	-
NR232	B	B	E	-	A	D
NR311Ni	B	B	E	A	-	-
NS3M	C	C	E	B	-	-
NR311	C*	C*	E	B	-	-
LH70	-	-	-	A	A	D
LH75	-	-	-	A	A	D
L61 w/860 flux	-	-	-	A	A	D
OS70	-	-	-	A	C	D

* Expected based on chemical composition differences.

7 Welding Techniques and Variables

7.1 SMAW

Amperage: Covered electrodes of a specific size and classification will operate satisfactorily at various amperages within a certain range. This range will vary somewhat with the thickness and formulation of the covering. Manufacturer’s guidelines should be followed because flux coverings are of different compositions.

Voltage: Voltage on a CC machine will be determined by arc length, which is determined by the operator. It is not a presettable parameter. Operators should hold short arc lengths to minimize the generation of spatter, and to optimize mechanical properties.

Travel speed: Travel speed is determined by the rate at which the electrode travels along the joint. The proper travel speed is the one which produces a weld bead of proper contour and appearance. Training and experience will help in determining proper appearance. Code restrictions on bead sizes will directly affect the required travel speeds for a given deposition rate.

Electrode diameter: The correct electrode diameter is one that, when used with the proper amperage and travel speed, produces a weld of the required quality and size in the least amount of time. Also, the correct electrode is determined by the thickness of the material to be welded. As a general rule, 1/8 and 5/32 in. diameter electrodes are used for out-of-position welding. For flat and horizontal welding, typical electrode diameters are 3/16 and 7/32 in. Larger electrodes may be used, but suitability is highly dependent on the joint and weld type.

Drag angle: The drag angle is the angle between the electrode centerline and the seam centerline in the direction of travel.

Polarity: Use DC+ whenever possible if the electrode size is 5/32 in. or less. For larger electrodes, use AC for best operating characteristics (but DC can also be used).

Flat position: Use low current within the acceptable range of the electrode on the first pass, or whenever it is desirable to reduce admixture with a base metal of poor weldability. On succeeding passes, use currents that provide the best operating characteristics. Drag the electrode lightly or hold an arc of 1/8 in. or less. Do not use a long arc at any time, since E7018 electrodes rely principally on molten slag for shielding. Stringer beads or small weave passes are preferable to wide weave passes. When starting a new electrode, strike the arc ahead of the crater, move back into the crater, and then proceed in the normal direction. On AC, use currents about 10% higher than those used with DC. Govern travel speed by the desired bead size.

Vertical: Weld vertical-up with electrode sizes of 5/32 in. or less. For E7018, use a triangular weave for heavy single pass welds. For multipass welds, first deposit a stringer bead by using a slight weave. Deposit additional layers with a side-to-side weave, hesitating at the sides long enough to fuse out any small slag pockets and to minimize undercut. Do not use a whip technique or take the electrode out of the molten pool. Travel slowly enough to maintain the shelf without causing

metal to spill. Use currents in the lower portion of the acceptable range.

Overhead: Use electrodes of 5/32 in. or smaller. For E7018, deposit stringer beads by using a slight circular motion in the crater. Maintain a short arc. Motions should be slow and deliberate, but fast enough to avoid spilling weld metal; do not be alarmed if some slag spills. Use currents in the lower portion of the acceptable range.

7.2 FCAW-ss

Semiautomatic operating techniques: Before welding, control settings should be carefully checked. The control settings should be within the range specified by the procedures, and adjusted according to past experience with the specific joint. Drive rolls and wire guide tubes should be correct for the wire size, and drive-roll pressure should be adjusted according to the manufacturer's instructions. The wire feeder and power source should be set for constant-voltage output. The gun, cable, and nozzle contact tip should be correct for the wire size and for the stickout.

Amperage: Manufacturer's guidelines should be followed because flux core contents are of different compositions.

Wire feed speed: The value selected should be within the manufacturer's recommended range of operation, and appropriate for the specific joint and skill of the operator.

Voltage: The arc voltage will be specified by the electrode manufacturer. System voltages may be higher due to voltage drops. Excessive arc voltage leads to porosity. Voltage should be measured from the wire feeder to the work.

Travel speed: Bead sizes are dependent on travel speeds. Excessively large or excessively small weld beads can reduce weld quality. Excessively slow travel speeds can lead to fusion problems and encourage slag entrapment. Very high travel speeds can result in reduced penetration, irregular wetting, lack of slag coverage and rough-appearing beads.

Electrode diameter: For out-of-position welding recommendations, electrode diameters are typically 1/16 to 5/64 in. For flat and horizontal welding, electrode diameters range from 5/64 to 0.120 in.

Electrical stickout: The distance between the point of electrical contact and the electrode tip is referred to as "stickout" or "electrical stickout." The entire length of electrode — not just the visible portion protruding from the nozzle — is subject to resistance heating as the current passes through it. The longer the projection of the electrode from the point of electrical contact, the greater the heat build-up within it. This heat can be used to good advantage to increase the melting rate and reduce penetration. Electrode extensions vary from 1/2 to 3-3/4 in., so the electrode manufacturer's recommendations should be consulted. The selection of an electrode extension must also be appropriate for the joint being welded. Root passes, and joints requiring penetration, are best made with shorter electrode extension dimensions.

Starting the arc: To start the arc, the electrode is "inched" out beyond the nozzle to the visible stickout recommended for the electrode size and guide tip. The tip of the electrode is positioned just off, or lightly touching, the joint, and the trigger is pressed to start the arc. The electrode should not be pushed into the joint as it melts away, as in stick electrode welding, since the mechanical feed will take care of advancing the electrode. Welding is stopped by releasing the trigger or quickly pulling the gun from the work. The instruction manual for a specific wire feeder usually gives recommendations on setting feed speed and open-circuit voltage to facilitate starting.

Accommodating poor fit-up: One of the advantages of FCAW is the ability to handle poor fit-up. Pulling the gun away from the work to increase the visible stickout reduces the current, and thus the penetration, and helps to avoid melt-through. After a poor fit-up area has been traversed, normal stickout should be used for the remainder of the joint.

With electrodes designed for out-of-position welding, poor fit-up can be handled by reducing the welding current to the minimum value specified in the procedures. Increasing the stickout to 1-1/2 in. also helps to reduce penetration and melt-through.

Removing slag: Slag removal is easy in most self shielded flux cored electrode welding. In heavy fast-fill work, the slag often curls up and peels off behind the welding gun. Otherwise, a light scrape with a chipping hammer or wire brush is usually all that is needed to dislodge the slag. Slag is occasionally trapped on fillet welds made in

the vertical position, or on groove welds in a flat position that have a convex bead. Entrapment can be avoided by proper bead location and drag angle and by using a smooth, even travel speed to insure good bead shape.

Drag angle: The drag angle is the angle between the electrode centerline and the seam centerline in the direction of travel. The desired drag angle is approximately the same as in SMAW. If slag tends to run ahead of the arc, the drag angle should be decreased.

Joint angle: The joint angle is the angle between the electrode centerline and the joint on a plane perpendicular to the weld axis.

For the best bead shape on most 5/16 in. and larger horizontal fillets, the electrode should point at the bottom plate and the angle between the electrode and bottom plate should be less than 45°. With this arrangement, the molten metal washes up onto the vertical plate. Pointing the electrode directly into the joint and using a 45 to 55° angle will decrease root-porosity problems, if they occur, but may produce spatter and a convex bead. For 1/4 in. and smaller fillets, the electrode should be pointed directly into the joint and the electrode angle held at about 40°.

For vertical and overhead welding with E71T-8 type electrodes, similar techniques are used. Vertical up, multiple pass welding should generally be with a split weave pass sequence, with each bead approximately 3/8 in. wide. Some E71T-8 type electrodes are capable of vertical down operation; for those products, a straight progression technique is normally recommended. Vertical down WPSs must be qualified by test for work done to D1.1-96.

7.3 FCAW-g

Generally the same operating techniques and precautions as those recommended for self shielded flux cored arc welding should be observed for gas shielded flux cored arc welding. The use of a shielding gas allows a wider variation in the metal transfer mode than is attainable with the self shielded process.

Wire feed speed: The value selected should be within the manufacturer's recommended range of operation, and appropriate for the specific joint or operator skill.

Amperage: Welding current is directly proportional to electrode feed rate for a specific electrode diameter, composition, and electrode extension. Manufacturer's guidelines should be followed because flux core contents are of different compositions.

Voltage: If the arc voltage is too high, the bead tends to widen in an irregular manner, with excessive spatter. Too low an arc voltage results in a narrow, high bead with excessive spatter and reduced penetration. Different types of gases will affect voltage (higher or lower).

Travel speed: As with other mechanized processes, travel rate affects the build-up of molten metal and penetration into the base material. Slow travel increases penetration, but excessively slow travel can lead to excessive build-up of molten metal, overheating of the weld area, and a rough-appearing bead. Too high travel rates may result in inadequate penetration and a ropy, irregular bead. Travel rates between 12 and 30 in. per minute usually give satisfactory results.

Electrical stickout: Varying the electrode stickout — as with self shielded flux cored welding and submerged arc welding — offers a method of controlling deposition rate and penetration. At a given rate of wire feed, a shorter stickout results in deeper penetration than a longer stickout. With gas shielded flux cored electrodes, stickout of 3/4 to 1-1/4 in. is usually recommended, depending on the type of nozzle. If the stickout is excessive, spatter occurs, and arc shielding is lost. The gas nozzle must be adjusted as stickout is changed to ensure adequate shielding at the arc.

Electrode diameter: Proper electrode diameter for a given weld will produce a weld in the least amount of time for a given thickness. For out-of-position welding, electrode diameters of 0.045 to 1/16 in. are typically used. For flat and horizontal welding, electrode diameters of 1/16 to 3/32 in. are typical.

Polarity: DC+ is always used for FCAW-g.

Drag angle: In a butt joint, the electrode should be perpendicular to the joint and slanted from 2° to 15° in the direction of travel. The leading angle results in a “lagging” gas shield, with much of the gas flowing back over the newly deposited weld metal. With a fillet weld, the electrode is dropped off center of the joint approximately half the diameter of the electrode, and a leading angle of 2° to 15° is used.

Distance to nozzle: The distance of the nozzle to the work, as well as the electrical stickout, influences the performance. The recommended nozzle-to-work distance is 3/4 to 1 in., which, with concentric-type nozzles, will give an electrical stickout of about 1 to 1-1/4 in. If the nozzle-to-work distance is too short, spatter may rapidly build up on the nozzle and contact tube. With side-shielded nozzles, electrical stickout is normally set at 3/4 to 1-1/4 in.

Shielding gas: Shielding gas is used to exclude the atmosphere from contact with the molten weld metal. Proper shielding gas and flow will depend on material type and location. CO₂ is generally used; however, mixtures of CO₂, argon and oxygen can be used.

7.4 SAW

Amperage: Welding current determines the rate at which the electrode is melted, the depth of penetration of the weld pool into the base metal, and the amount of base metal fused. An increase in current increases penetration and melt-off rate, but an excessively high current produces a high, narrow bead, an erratic arc, and undercut. Excessively low current produces an unstable arc. Welding amperages range from: 200-600 amps for 5/64 in., 230-700 amps for 3/32 in., 300-900 amps for 1/8 in., 420-1000 amps for 5/32 in., and 600-1200 amps for 7/32 in. electrodes.

Wire feed speed: SAW welding procedures can be controlled with wire feed speed as well as amperage. Wire feed speed control would be the preferred method for SAW welding on CV systems. For CC welding, amperage is usually used as the reference control.

Voltage: Welding voltage influences the shape of the weld cross section and the external appearance of the weld. Increasing voltage produces a flatter wider bead, increases flux consumption, and increases resistance to porosity caused by rust or scale. Excessively high voltage produces a “hat-shaped” bead that is subject to cracking, makes slag removal difficult, and produces a concave fillet weld that is subject to cracking.

Travel speed: Travel speed is set primarily to control bead size and penetration. In single pass welds, the current and travel speed should be set to get the desired penetration without melt-through. For multiple-pass welds, the current and travel speed should be set to get the desired bead size.

Electrical stickout: Typically, electrical stickout for SAW ranges from 1 to 2 in. Deposition rates with long-stickout welding (2 to 4 in.) are typically increased some 25 to 50% with no increase in welding current. With single electrode, fully automatic submerged arc welding, the deposition rate may approach that of two-wire welding with a multiple power source. Limitations exist and literature should be evaluated for each application.

Electrode diameter: Generally, only the 1/16, 5/64, and 3/32 in. electrodes are used for semiautomatic welding. The 1/16 in. wire is used for making high-speed fillet welds on steel ranging from 14-gauge to 1/4 in. thick. The 5/64 in. electrode is used for fillet and groove welds when the welding gun is hand-held. The 3/32 in. wire is used primarily when the gun is carried mechanically. Electrodes of this diameter can be used for hand-held operation, but the stiffness of the wire tends to make the cable rigid and thereby decrease the maneuverability of the gun. Fully automatic submerged arc welding generally employs electrodes from 5/64 to 7/32 in. diameter.

Polarity: DC+ is recommended for most submerged arc welding where fast-follow or deep penetration are important. Negative polarity gives a melt-off rate about one-third greater than that of positive polarity, but negative polarity also produces less penetration for a given wire feed speed. AC is recommended for two specific submerged arc applications: for the trailing electrode when tandem-arc welding, or for occasional single-arc applications where arc blow is limiting DC current and slowing travel speed.

Flux Type: Fluxes can be defined by a variety of methods, depending on the particular operating characteristic of interest. Fluxes may generally be classified as fused, bonded, or agglomerated. Fused fluxes require that the ingredients used be melted, and then crushed into small particles. A general disadvantage of fused fluxes is that it is impossible to incorporate into these materials ingredients that perform their functions at temperatures lower than the melting point of the ingredients. In general, this limits the applicability of fused fluxes to applications with less demanding mechanical properties. Bonded fluxes utilize water as a binder, and the resulting product is generally quite hygroscopic, absorbing moisture out of the atmosphere. Agglomerated fluxes utilize a high temperature silicate binder. This system permits the use of a wider range of chemical ingredients for optimized welding conditions and mechanical properties. The use of the high temperature binder minimizes moisture pickup ten-

dencies, although fluxes still must be protected from moisture absorption where moisture condenses on the surface of the flux.

Fluxes may also be classified based on their relative neutrality. Neutrality is defined as the sensitivity of a flux to silicon and/or manganese changes as a function of arc voltage. Fluxes that are relatively immune from changes in the manganese and silicon content as the voltage is changed are known as neutral fluxes, while those that experience a significant change in composition with respect to these two elements over a range of voltage are called 'active'. The Wall Neutrality Number is defined as the absolute change in composition (that is, an increase or decrease) with respect to manganese and silicon between weld deposits made at 28 volts and 36 volts. Since the resultant number is small, the sum of the absolute values of the percentage change to these elements is multiplied by 100. When the Wall Neutrality Number is 40 or less, the product is considered neutral, and when the value is greater than 40, it is considered active.

Active fluxes are ideal for single or limited pass welding, particularly on surfaces that contain contaminants such as oil, scale, or rust. The added level of oxidizers associated with active fluxes encourages high resistance to porosity and generates good bead shapes with excellent slag removal. The higher manganese content can also be helpful in minimizing centerline cracking problems due to high sulphur plate. Neutral fluxes are ideal for multiple pass welds on heavier material, particularly when high notch toughness levels are desired. While the silicon and manganese content may increase to unacceptable levels on multiple pass welding when active fluxes are used, the use of neutral fluxes minimizes this problem. In general, neutral fluxes are best for multiple pass welding on 1 in. plate and greater, and active fluxes are best when applied for single or limited pass welding. For multiple pass welding with active fluxes on plate less than 1 in. thick, it is recommended that the electrode be a low silicon, low manganese electrode, and the arc voltage should be controlled to minimize the potential of alloy (manganese and silicon) accumulation.

Flux depth: The width and depth of the granular layer of flux influence the bead appearance and soundness of the finished weld as well as the welding action. If the granular layer is too deep, the arc is too confined and a rough weld with a rope-like appearance will result. The gases generated during welding cannot escape. If the granular layer is too shallow, the arc will not be entirely sub-

merged in flux. Flashing and spattering will occur. The weld will have a poor appearance, and it may be porous.

Electrode type: The primary selection criteria for solid electrode are the required mechanical properties and the chemistry of the deposited weld metal. Specific conditions may further affect electrode choice, such as the level of rust or mill scale that will be encountered.

Electrode alignment: The electrode should be kept in position using the alignment guide. The plane of alignment should be perpendicular to the surface of the work. Improper alignment produces undesirable bead shapes.

Work leads: The location of work connections is important, especially on short welds. Both AC and DC work connections should be at the start of the weld, unless back blow is desired to keep weld metal from running ahead of the arc. Where back blow is desired, the weld should be made toward the work connection.

Nozzles: The cone tip establishes proper flux coverage when using the drag technique that is recommended for most joints. In general, use the smallest cone tip that will provide sufficient flux coverage to avoid flash-through and permit making the desired size weld. The smaller the cone tip, the more positive the alignment of the wire with the seam. This is particularly important when making small welds at high speed.

7.5 GMAW

Amperage: The current is adjusted by changing the wire feed speed. Welding current will largely depend upon the type of metal transfer that is required for a given design. Details of these modes are in section 2.

Voltage: Arc voltage is considered to be the electrical potential between electrode and the workpiece. Increasing or decreasing the output voltage of the power source will increase or decrease the arc length. Different types of gases will affect voltage (higher or lower).

Travel speed: Desired bead width and penetration are directly affected by travel speed. Travel speed should be fast enough to acquire the desired penetration. Travel that is too slow will allow the welding arc to concentrate on the hot weld pool, resulting in a flat wide bead. Travel that is too fast will place the arc on cold metal, giving a narrow mounded bead.

Electrical stickout: Electrode extension will depend upon the current and voltage used with a specified wire. GMAW electrode extensions range from 1/4 to 1 in.

Electrode diameter: The electrode size influences the weld bead configuration. Proper electrode diameter is dependent upon the application being used, material thickness, and weld size desired. For flat and horizontal welding, electrode diameters of 0.045, 0.052, and 1/16 in. are used. Out-of-position welding is typically done with 0.035 and 0.045 in. diameter electrodes.

Polarity: A DC+ constant voltage power source is recommended for GMAW. More sophisticated power sources have been developed especially for gas metal arc welding. Pulsed arc equipment should be considered for out-of-position GMAW.

Shielding gas: Shielding gas is used to exclude the atmosphere from contact with the molten weld metal. Proper shielding gas and flow will depend on material type and location. Two inert gases are used: argon and helium. CO₂ is also used either as a sole shielding gas or as a mixture with argon or helium. Small amounts of oxygen may be added to argon. Tri- or quad-mixes are also available for use.

7.6 ESW/EGW

Due to the complexity of these processes and the fact that they are not prequalified processes, ESW/EGW variables are not listed here.

8 Welder Qualification

Qualification tests are specifically designed to determine the ability of a welder to produce sound welds by following a WPS. The code does not imply that anyone who satisfactorily completes qualification tests can do the welding for which he or she is qualified under all conditions that might be encountered during production welding. It is essential that welders receive some degree of training for these differences (D1.1-96, Commentary C4.1.2).

The most efficient route to qualify for a particular method is to perform tests in the 3G and 4G positions using 1 in. plate. Successful completion of these tests would qualify a welder in all groove and fillet positions for any plate thickness (D1.1-96, paragraph 4.18.1.2-2.1, Tables 4.8, 4.9).

All WPS qualification test plates are required to be visually inspected as well as radiographically or ultrasonically tested to demonstrate soundness, before being mechanically tested. The type of tests required are found in D1.1-96, paragraph 4.19, whereas the exact testing requirements are listed in D1.1-96, paragraph 4.30. Also, all CJP, PJP, and fillet welds for nontubular connections will be in accordance with D1.1-96, paragraphs 4.23, 4.24, 4.25.

A welder's qualification will remain in effect for six months beyond the date that the welder last used the welding process, or until there is a specific reason to question the welder's ability. The requalification test need only be made using a 3/8 in. thick plate. If the welder fails the requalification test, then a retest shall not be permitted until further training and practice have taken place. If there is a specific reason to question the welder's ability, then the type of test shall be mutually agreed upon between the contractor and the Engineer, and shall be within the requirements of Section 4, Part C (D1.1-96, paragraph 4.32).

Welders must be trained to understand the proper welding techniques and approaches necessary to make quality welds under specific conditions. Qualification tests do not realistically duplicate many field conditions. Training on mock-up assemblies can help to develop the skills required for specific situations.

9 Weld Cracking

Several types of discontinuities may occur in welds or heat affected zones. Welds may contain porosity, slag inclusions or cracks. Of the three, cracks are by far the most detrimental. Whereas there are acceptable limits for slag inclusions and porosity in welds, cracks are never acceptable. Cracks in a weld, or in the vicinity of a weld, indicate that one or more problems exist that must be addressed. A careful analysis of crack characteristics will make it possible to determine the cause and take appropriate corrective measures.

For the purposes of this section, "cracking" will be distinguished from weld failure. Welds may fail due to over-load, underdesign, or fatigue. The cracking discussed here is the result of solidification, cooling, and the stresses that develop due to weld shrinkage. Weld cracking occurs close to the time of fabrication. Hot cracks are those that occur at elevated temperatures and are usually solidification related. Cold cracks are those that occur after the weld metal has cooled to room tempera-

ture and may be hydrogen related. Neither is the result of service loads.

Most forms of cracking result from the shrinkage strains that occur as the weld metal cools. If the contraction is restricted, the strains will induce residual stresses that cause cracking. There are two opposing forces: the stresses induced by the shrinkage of the metal, and the surrounding rigidity of the base material. The shrinkage stresses increase as the volume of shrinking metal increases. Large weld sizes and deep penetrating welding procedures increase the shrinkage strains. The stresses induced by these strains will increase when higher strength filler metals and base materials are involved. With a higher yield strength, higher residual stresses will be present.

Under conditions of high restraint, extra precautions must be utilized to overcome the cracking tendencies which are described in the following sections. It is essential to pay careful attention to welding sequence, preheat and interpass temperature, postweld heat treatment, joint design, welding procedures, and filler material. The judicious use of peening as an in-process stress relief treatment may be necessary when fabricating highly restrained members.

9.1 Centerline Cracking

Centerline cracking is characterized as a separation in the center of a given weld bead. If the weld bead happens to be in the center of the joint, as is always the case on a single pass weld, centerline cracks will be in the center of the joint. In the case of multiple pass welds, where several beads per layer may be applied, a centerline crack may not be in the geometric center of the joint, although it will always be in the center of the bead (Figure 9-1).

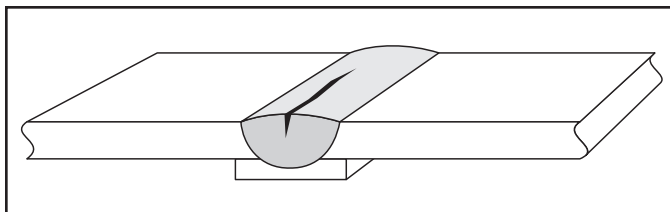

Figure 9-1 Centerline cracking

Centerline cracking is the result of one of the following phenomena: **segregation induced cracking**, **bead shape induced cracking**, or **surface profile induced cracking**. Unfortunately, all three phenomena reveal themselves in the same type of crack, and it is often difficult to identi-

fy the cause. Moreover, experience has shown that often two or even all three of the phenomena will interact and contribute to the cracking problem. Understanding the fundamental mechanism of each of these types of centerline cracks will help in determining the corrective solutions.

Segregation induced cracking occurs when low melting point constituents such as phosphorous, zinc, copper and sulfur compounds in the admixture separate during the weld solidification process. Low melting point components in the molten metal will be forced to the center of the joint during solidification, since they are the last to solidify and the weld tends to separate as the solidified metal contracts away from the center region containing the low melting point constituents.

When centerline cracking induced by segregation is experienced, several solutions may be implemented. Since the contaminant usually comes from the base material, the first consideration is to limit the amount of contaminant pick-up from the base material. This may be done by limiting the penetration of the welding process. In some cases, a joint redesign may be desirable. The extra penetration afforded by some of the processes is not necessary and can be reduced. This can be accomplished by using lower welding currents.

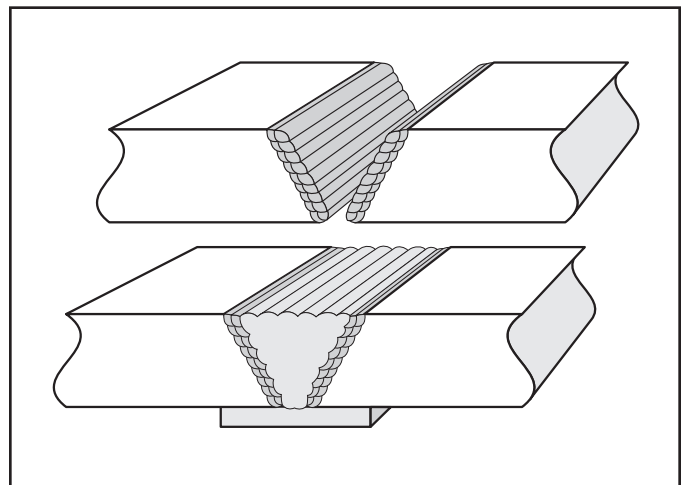

Figure 9-2 Buttering layers

A buttering layer of weld material (Figure 9-2), deposited by a low energy process such as shielded metal arc welding, may effectively reduce the amount of pick-up of contaminant into the weld admixture.

In the case of sulfur, it is possible to overcome the harmful effects of iron sulfides by preferentially forming man-

ganese sulfide. Manganese sulfide (MnS) is created when manganese is present in sufficient quantities to counteract the sulfur. Manganese sulfide has a melting point of 2,900°F. In this situation, before the weld metal begins to solidify, manganese sulfides are formed which do not segregate. Steel producers utilize this concept when higher levels of sulfur are encountered in the iron ore. In welding, it is possible to use filler materials with higher levels of manganese to overcome the formation of low melting point iron sulfide. Unfortunately, this concept cannot be applied to contaminants other than sulfur.

The second type of centerline cracking is known as **bead shape induced cracking**. This is illustrated in Figure 9-3 and is associated with deep penetrating processes such as SAW and CO₂ shielded FCAW. When a weld bead is of a shape where there is more

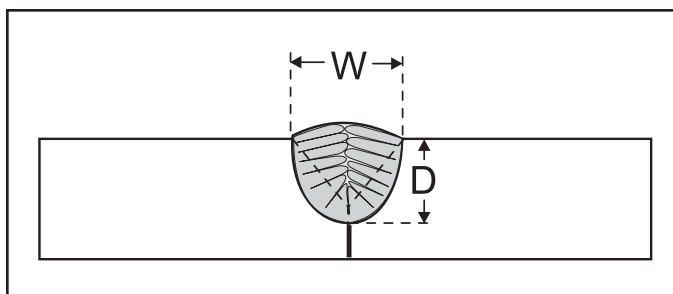

Figure 9-3 Bead shape induced cracking

depth than width to the weld cross section, the solidifying grains growing perpendicular to the steel surface intersect in the middle, but do not gain fusion across the joint. To correct for this condition, the individual weld beads must have at least as much width as depth. Recommendations vary from a 1:1 to a 1.4:1 width-to-depth ratio to remedy this condition. The total weld configuration, which may have many individual weld beads, can have an overall profile that constitutes more depth than width. If multiple passes are used in this situation, and each bead is wider than it is deep, a crack-free weld can be made.

When centerline cracking due to bead shape is experienced, the obvious solution is to change the width-to-depth relationship. This may involve a change in joint design. Since the depth is a function of penetration, it is advisable to reduce the amount of penetration. This can be accomplished by utilizing lower welding amperages and larger diameter electrodes. All of these approaches will reduce the current density and limit the amount of penetration.

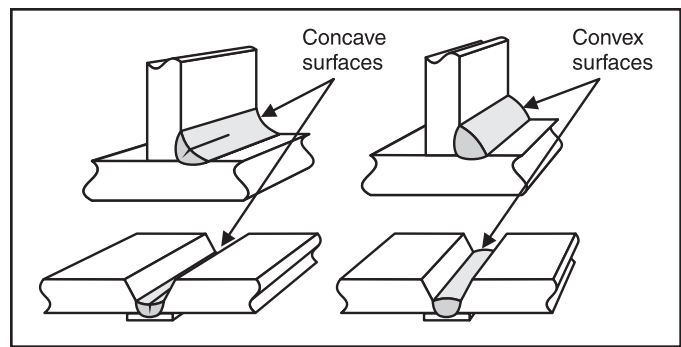

Figure 9-4 Surface profile induced cracking

The final mechanism that generates centerline cracks is **surface profile conditions**. When concave weld surfaces are created, internal shrinkage stresses will place the weld metal on the surface into tension. Conversely, when convex weld surfaces are created, the internal shrinkage forces will pull the surface into compression. These situations are illustrated in Figure 9-4. Concave weld surfaces frequently are the result of high arc voltages. A slight decrease in arc voltage will cause the weld bead to return to a slightly convex profile and eliminate the cracking tendency. High travel speeds may also result in this configuration. A reduction in travel speed will increase the amount of fill and return the surface to a convex profile. Vertical-down welding also has a tendency to generate these crack-sensitive, concave surfaces. Vertical-up welding can remedy this situation by providing a more convex bead.

9.2 Heat Affected Zone Cracking

Heat affected zone (HAZ) cracking (Figure 9-5) is characterized by separation that occurs immediately adjacent to the weld bead. Although it is related to the welding process, the crack occurs in the base material, not in the weld material. This type of cracking is also known as “underbead cracking,” “toe cracking,” or “delayed cracking.” Because this cracking occurs after the steel has cooled below approximately 400°F, it can be called “cold cracking”, and because it is associated with hydrogen, it is also called “hydrogen assisted cracking.”

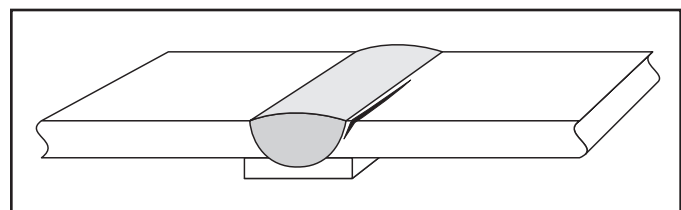

Figure 9-5 Heat affected zone cracking

In order for heat affected zone cracking to occur, three conditions must be present simultaneously: there must be a sufficient level of hydrogen; there must be a sufficiently sensitive material involved; and, there must be a sufficiently high level of residual or applied stress. Adequate reduction or elimination of one of the three variables will generally eliminate heat affected zone cracking. In welding applications, the typical approach is to limit two of the three variables, namely the level of hydrogen and the sensitivity of the material.

Hydrogen can enter into a weld pool from a variety of sources. Moisture and organic compounds are the primary sources of hydrogen. It may be present on the steel, the electrode, in the shielding materials, and is present in the atmosphere. Flux ingredients, whether on the outside of electrodes, inside the core of electrodes, or in the form of submerged arc or electroslag fluxes, can absorb moisture, depending on storage conditions and handling practices. To limit hydrogen content in deposited welds, welding consumables must be properly maintained, and welding must be performed on surfaces that are clean and dry.

The second necessary condition for heat affected zone cracking is a sensitive microstructure. The area of interest is the heat affected zone that results from the thermal cycle experienced by the region immediately surrounding the weld nugget. As this area is heated by the welding arc during the creation of the weld pool, it is transformed from its room temperature structure of ferrite to the elevated temperature structure of austenite. The subsequent cooling rate will determine the resultant HAZ properties. Conditions that encourage the development of crack sensitive microstructures include high cooling rates and higher hardenability levels in the steel. High cooling rates are encouraged by lower heat input welding procedures, greater base metal thicknesses, and colder base metal temperatures. Higher hardenability levels result from greater carbon contents and/or alloy levels. For a given steel, the most effective way to reduce the cooling rate is by raising the temperature of the surrounding steel through preheat. This reduces the temperature gradient, slowing cooling rates, and limiting the formation of sensitive microstructures. Effective preheat is the primary means by which acceptable heat affected zone properties are created, although heat input also has a significant effect on cooling rates in this zone.

The residual stresses of welding can be reduced through thermal stress relief, although for most structural applications, this is economically impractical. For complex structural applications, temporary shoring and other conditions must be considered, as the steel will have a greatly reduced strength capacity at stress relieving temperatures. For practical applications, heat affected zone cracking will be controlled by effective low hydrogen practices, and appropriate preheats.

For HAZ hydrogen cracking to occur, it is necessary for the hydrogen to migrate into the heat affected zone, which takes time. For this reason, the D1.1 Code (D1.1-96, paragraph 6.11) requires a delay of 48 hours after completion of welds for the inspection of welds made on A514, A517 and A709 Gr. 100 and 100W steels, known to be sensitive to hydrogen assisted heat affected zone cracking.

With time, hydrogen diffuses from weld deposits. Sufficient diffusion to avoid cracking normally takes place in a few weeks, although it may take many months depending on the specific application. The concentrations of hydrogen near the time of welding are always the greatest, and if hydrogen induced cracking is to occur, it will generally occur within a few days of fabrication. However, it may take longer for the cracks to grow to sufficient size to be detected.

Although a function of many variables, general diffusion rates can be approximated. At 450°F, hydrogen diffuses at the rate of approximately 1 in. per hour. At 220°F, hydrogen diffuses the same 1 in. in approximately 48 hours. At room temperature, typical diffusible hydrogen rates are 1 in. per 2 weeks. If there is a question regarding the level of hydrogen in a weldment, it is possible to apply a postweld heat treatment commonly called "post heat." This generally involves the heating of the weld to a temperature of 400 - 450°F, holding the steel at that temperature for approximately one hour for each inch of thickness of material involved. At that temperature, the hydrogen is likely to be redistributed through diffusion to preclude further risk of cracking. Some materials, however, will require significantly longer than 1 hour per inch. This operation may not be necessary where hydrogen has been properly controlled, and it is not as powerful as preheat in terms of its ability to prevent underbead cracking. In order for post heat operations to be effective, they must be applied before the weldment is allowed to cool to room temperature. Failure to do so could result in heat affected zone cracking prior to the application of the post heat treatment.

9.3 Transverse Cracking

Transverse cracking, also called cross cracking, is characterized as a crack within the weld metal perpendicular to the direction of travel (Figure 9-6). This is the least frequently encountered type of cracking, and is generally associated with weld metal that is higher in strength, significantly overmatching the base material. This type of cracking can also be hydrogen assisted, and like the heat affected zone cracking described in 9.1, transverse cracking is also a factor of excessive, hydrogen, residual stresses, and a sensitive microstructure. The primary difference is that transverse cracking occurs in the weld metal as a result of the longitudinal residual stress.

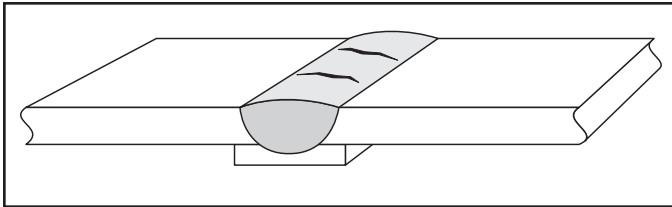

Figure 9-6 Transverse cracking

As the weld bead shrinks longitudinally, the surrounding base material resists this force by going into compression. The high strength of the surrounding steel in compression restricts the required shrinkage of the weld material. Due to the restraint of the surrounding base material, the weld metal develops longitudinal stresses which may facilitate cracking in the transverse direction.

When transverse cracking is encountered, a review of the low hydrogen practice is warranted. Electrode storage conditions should be carefully reviewed. If this is a problem, a reduction in the strength of the weld metal will usually solve transverse cracking problems. Of course, design requirements must still be met, although most transverse cracking results from weld metal over matching conditions.

Emphasis is placed upon the weld metal because the filler metal may deposit lower strength, highly ductile metal under normal conditions. However, with the influence of alloy pick-up, it is possible for the weld metal to exhibit extremely high strengths with reduced ductility. Using lower strength weld metal is an effective solution, but caution should be taken to ensure that the required joint strength is attained.

Preheat may have to be applied to alleviate transverse cracking. The preheat will assist in diffusing hydrogen.

As preheat is applied, it will additionally expand the length of the weld joint, allowing the weld metal and the joint to contract simultaneously, and reducing the applied stress to the shrinking weld. This is particularly important when making circumferential welds. When the circumference of the materials being welded is expanded, the weld metal is free to contract along with the surrounding base material, reducing the longitudinal shrinkage stress. Finally, post weld hydrogen release treatments that involve holding the steel at 250-450°F for extended periods of time (generally 1 hour per in. of thickness) will assist in diffusing any residual hydrogen.

10 Weld Quality and Inspection

10.1 Weld Quality

A weld must be of an appropriate quality to ensure that it will satisfactorily perform its function over its intended lifetime. Weld “quality” is therefore directly related to the purpose the weld must perform. Codes or contract documents define the required quality level for a specific project, meaning that a quality weld is one that meets the applicable requirements. Ensuring that the requirements have properly addressed the demands upon the weld is ultimately the responsibility of the Engineer.

All welds contain **discontinuities**, which are defined as an interruption in the typical structure of the material, such as a lack of homogeneity in its mechanical, metallurgical, or physical characteristics (AWS A3.0). Such irregularities are not necessarily defects. A **defect** is defined as a discontinuity that is unacceptable with respect to the applicable standard or specification. Defects are not acceptable; discontinuities may, or may not, be acceptable.

Welds are not required to be “perfect,” and most welds will contain some discontinuities. It is imperative that the applicable standards establish the level of acceptability of these discontinuities in order to ensure both dependable and economical structures. AWS D1.1 is the primary standard used to establish workmanship requirements. In general, these are based upon the quality level achievable by a qualified welder, which does not necessarily constitute a boundary of suitability for service. If the weld quality for each type of weld and loading condition were specified, widely varying criteria of acceptable workmanship would be required. Moreover, acceptable weld quality (in some cases) would be less rigorous than what would be normally produced by a qualified welder.

(D1.1-96, page 404, Commentary C6.8). This suggests that, in some instances, the D1.1 requirements exceed the actual requirements for acceptable performance. The Engineer of Record can use a “fitness for purpose” evaluation to determine alternate acceptance criteria in such situations. Some specific loading conditions require more stringent acceptance criteria than others. For example, undercut associated with fillet welds would constitute a stress riser when the fillet weld is loaded in tension perpendicular to its longitudinal axis. However, when the same fillet weld is loaded in horizontal shear, this would not be a stress riser, and more liberal allowances are permitted for the level of undercut.

A variety of types of discontinuities can exist in welds. Characteristics, causes, and cures of common examples may be summarized as follows:

Undercut is a small cavity that is melted into the base metal adjacent to the toe of a weld that is not subsequently filled by weld metal. Improper electrode placement, extremely high arc voltages, and the use of improper welding consumables may result in undercut. Changes to the welding consumable and welding procedures may alleviate undercut.

Excess concavity or excess convexity are weld surface profile irregularities. These may be operator- and/or procedure-related.

Overlap (or cold-lap) is the protrusion of weld metal beyond the toe of the weld where the weld metal is not bonded to the base material. Overlap usually is associated with slow travel speeds.

Incomplete penetration is associated with weld joint details that rely on melting of base metal to obtain the required weld strength. A typical example would be a square-edged butt joint. Incomplete penetration occurs when the degree of penetration is inadequate, and is generally attributable to insufficient current density, improper electrode placement, or excessively slow travel speeds.

Lack of fusion, or incomplete fusion, is the result of the failure of the weld metal and the base metal to form the metallurgical bonds necessary for fusion. Lack of fusion can range from small, isolated planes, or, in extreme cases, may consist of a complete plane between the weld metal and the base metal where fusion does not exist. Improper filler metal selection, improper welding proce-

dures, and poor surface preparation are common causes of this condition. Improper use of GMAW short-circuiting transfer is a common cause of lack of fusion.

Arc strikes consist of small, localized regions of metal that have been melted by the inadvertent arcing between electrically charged elements of the welding circuit and the base metal. Welding arcs that are not initiated in the joint leave behind these arc strikes. Arcing of work clamps to the base metal can cause arc strikes, as can welding cables with improper insulation. SMAW is particularly susceptible to creating arc strikes since the electrode holder is electrically ‘hot’ when not welding. The use of properly insulated welding equipment and proper welding practices minimize arc strikes. Grinding away the affected (melted) metal is an effective way of eliminating any potential harm from arc strikes.

Slag inclusions describe non-metallic material entrapped in the weld metal, or between the weld metal and base metal. Slag inclusions are generally attributed to slag from previous weld passes that was not completely removed before subsequent passes were applied. Slag may be trapped in small cavities or notches, making removal by even conscientious welders difficult. Proper joint designs, welding procedures, and welder technique can minimize slag inclusions.

Spatter is the term used to describe the roughly spherical particles of molten weld metal that solidify on the base metal outside the weld joint. Spatter is generally not considered to be harmful to the performance of welded connections, although excessive spatter may inhibit proper ultrasonic inspection, and may be aesthetically unacceptable for exposed steel applications. Excessive spatter is indicative of less than optimum welding conditions, and suggests that the welding consumables and/or welding procedure may need to be adjusted.

Porosity consists of spherical or cylindrical cavities that are formed as gases entrapped in the liquid weld metal escape while the metal solidifies. The D1.1-96, Table 6.1 code defines acceptable limits for porosity as a function of its type, size, and distribution. Porosity occurs as the result of inadequate shielding of the weld metal, or excessive contamination of the weld joint, or both. The products used for shielding weld deposits (gases, slags) must be of appropriate quality, properly stored, and delivered at a rate to provide adequate shielding. Excessive surface contamination such as oil, moisture,

rust, or scale increases the demand for shielding. Porosity can be minimized by providing proper shielding, and ensuring joint cleanliness.

Cracking is the most serious type of weld discontinuity. Weld cracking is extensively discussed in section 9.

10.2 Weld Quality and Process-Specific Influences

Some welding processes are more sensitive to the generation of certain types of weld discontinuities, and some weld discontinuities are associated with only a few types of welding processes. Conversely, some welding processes are nearly immune from certain types of weld discontinuities. Contained below are the popular welding processes and their variations, along with a description of their associated sensitivity relative to weld quality.

SMAW — The unique limitations of shielded metal arc welding fall into three categories: arc length related discontinuities, start-stop related discontinuities, and coating moisture related problems. In SMAW, the operator controls arc length. Excessively short arc lengths can lead to arc outages, where the electrode becomes stuck to the work. When the electrode is mechanically broken off the joint, the area where the short has occurred needs to be carefully cleaned, usually ground, to ensure conditions that will be conducive to good fusion by subsequent welding. The electrode is usually discarded since a portion of the coating typically breaks off of the electrode when it is removed from the work. Excessively long arc lengths will generate porosity, undercut, and excessive spatter. Because of the finite length of the SMAW electrodes, an increased number of starts and stops is necessitated. During arc initiation with SMAW, starting porosity may result during the short time after the arc is initiated and before adequate shielding is established. Where the arc is terminated, under-filled weld craters can lead to crater cracking. The coatings of SMAW electrodes are sensitive to moisture pick-up. While newer developments in electrodes have extended the period for which electrodes may be exposed to the atmosphere, it is still necessary to ensure that the electrodes remain dry in order to be assured of low hydrogen welding conditions. Improper care of low hydrogen SMAW electrodes can lead to hydrogen assisted cracking, i.e., underbead cracking or transverse cracking. See 2.1 on care and storage of low hydrogen electrodes.

FCAW-g — In FCAW-g, as with all gas shielded processes, it is important to protect the gas shielding

around the weld deposit. If FCAW-g gas shields are disturbed by winds, fans, or smoke exhaust equipment, porosity can result. The deep penetrating characteristics of FCAW-g are generally advantageous, but excessive penetration can lead to centerline cracking because of a poor width-to-depth ratio in the weld bead cross section.

FCAW-ss — Excessively high arc voltages, or inappropriately short electrode extension dimensions can lead to porosity with FCAW-ss. When excessive voltages are used, the demand for shielding increases, but since the amount of shielding available is relatively fixed, porosity can result. When the electrical stickout distance is too short, there may be inadequate time for the various ingredients contained within the electrode core to chemically perform their function before they are introduced into the arc. This too can lead to porosity. Because of the extremely high deposition rate capability of some of the FCAW-ss electrodes, it is possible to deposit quantities of weld metal that may result in excessively large weld beads, leading to a decrease in fusion, if not balanced with a corresponding increase in travel speed.

SAW — Submerged arc welding is sensitive to alignment of the electrode with respect to the joint. Misplaced beads can result from improper bead placement. The deep penetration of the SAW process can lead to centerline cracking due to improper width-to-depth ratios in the bead cross section.

GMAW — When solid electrodes are used, and particularly when welding out-of-position, the short arc transfer mode is frequently used. This can directly lead to cold-lap, a condition where complete fusion is not obtained between the weld metal and base material. This is a major shortcoming of the GMAW process and is one of the reasons its application is restricted by the D1.1 code with respect to its prequalified status. As with all gas-shielded processes, GMAW is sensitive to the loss of gas shielding.

10.3 Weld Inspection

Weld quality is directly tied to the code or specification under which the work is being performed. Welds are acceptable when they conform to all the requirements in a given specification or code.

Five major non-destructive methods are used to evaluate weld metal integrity in steel structures. Each has unique advantages and limitations. Some discontinuities are

revealed more readily with one method as compared to another. It is important for the fabricator to understand the capacities and limitations of these inspection methods, particularly in situations where interpretation of the results may be questionable.

Visual inspection (VT) is by far the most powerful inspection method available. Because of its relative simplicity and lack of sophisticated equipment, some people discount its power. However, it is the only inspection method that can actually increase the quality of fabrication and reduce the generation of welding defects.

Most codes require that all welds be visually inspected. Visual inspection begins long before an arc is struck. Materials that are to be welded must be examined for quality, type, size, cleanliness, and freedom from defects. The pieces to be joined should be checked for straightness, flatness, and dimensions. Alignment and fit-up of parts should be examined. Joint preparation should be verified. Procedural data should be reviewed, and production compliance assured. All of these activities should precede any welding that will be performed.

During welding, visual inspection includes verification that the procedures used are in compliance with the Welding Procedure Specification (WPS). Upon completion of the weld bead, the individual weld passes are inspected for signs of porosity, slag inclusion, and any weld cracks. Bead size, shape, and sequences can be observed.

Interpass temperatures can be verified before subsequent passes are applied. Visual inspection can ensure compliance with procedural requirements. Upon completion of the weld, the size, appearance, bead profile and surface quality can be inspected.

Visual inspection may be performed by the weld inspector, as well as by the welder. Good lighting is imperative. In most fabrication shops, some type of auxiliary lighting is required for effective visual inspection. Magnifying glasses, gauges, and workmanship samples all aid in visual inspection.

Liquid **penetrant testing (PT)** involves the application of a liquid which by a capillary action is drawn into a surface breaking discontinuity, such as a crack or porosity. When the excess residual dye is carefully removed from the surface, a developer is applied, which will absorb the

penetrant that is contained within the discontinuity. This results in a stain in the developer showing that a discontinuity is present.

Dye penetrant testing is limited to surface discontinuities. It has no ability to read subsurface discontinuities, but it is highly effective in identifying the surface discontinuities that may be overlooked or be too small to detect with visual inspection. However, because it is limited to surface discontinuities, and because these discontinuities also will be observed with magnetic particle inspection, this method is not specified by most structural steel welding codes.

Magnetic particle inspection (MT) utilizes the change in magnetic flux that occurs when a magnetic field is present in the vicinity of a discontinuity. This change in magnetic flux density will show up as a different pattern when magnetic powders are applied to the surface of a part. The process is effective in locating discontinuities that are on the surface and slightly subsurface. For steel structures, magnetic particle inspection is more effective than dye penetrant inspection, and hence, is preferred for most applications. Magnetic particle inspection can reveal cracks very near the surface, slag inclusions, and porosity.

The magnetic field is created in the material to be inspected in one of two ways. Current is either directly passed through the material, or a magnetic field is induced through a coil on a yoke. With the first method, electrical current is passed through two prods that are placed in contact with the surface. When the prods are initially placed on the material, no current is applied. After intimate contact is assured, current is passed through. Small arcs may occur between the prods and the base material, resulting in an arc strike, which may create a localized brittle zone. It is important that prods be kept in good shape and that intimate contact with the work is maintained before the current is passed through the prods.

The second method of magnetic field generation is through induction. In what is known as the yoke method, an electrical coil is wrapped around a core, often with articulated ends. Electrical current is passed through the coil, creating a magnetic field in the core. When the ends of the yoke are placed in contact with the part being inspected, the magnetic field is induced into the part. Since current is not passed into the part, the potential for

arc strikes is eliminated. Along with this significant advantage, comes a disadvantage: the yoke method is not as sensitive to subsurface discontinuities as the prod method.

Cracks are most easily detected when they lie perpendicular to the magnetic field. With the prod method the magnetic field is generated perpendicular to the direction of current flow. For the yoke method, just the opposite is true. Magnetic particle inspection is most effective when the region is inspected twice: once with the field located parallel to, and once with the field perpendicular to, the weld axis.

While magnetic particle inspection can reveal some subsurface discontinuities, it is best used to enhance visual inspection. Fillet welds can be inspected with this method. Another common use of MT is for the inspection of intermediate passes on large groove welds, particularly in crack sensitive situations.

Radiographic inspection (RT) uses X-rays or gamma rays that are passed through the weld and expose a photographic film on the opposite side of the joint. X-rays are produced by high voltage generators, while gamma rays are produced by atomic disintegration of radioactive isotopes.

Whenever radiography is used, precautions must be taken to protect workers from exposure to excessive radiation. Safety measures dictated by the Occupational Safety and Health Administration (OSHA), the National Electrical Manufacturer's Association (NEMA), the Nuclear Regulatory Commission (NRC), the American Society of Nondestructive Testing (ASNT) and other agencies should be carefully followed when radiographic inspection is conducted.

Radiographic testing relies on the ability of the material to pass some of the radiation through, while absorbing part of this energy within the material. Different materials have different absorption rates. Thin materials will absorb less radiation than thick materials. The higher the density of the material, the greater the absorption rate. As different levels of radiation are passed through the materials, portions of the film are exposed to a greater or lesser degree than the rest. When this film is developed, the resulting radiograph will bear the image of the plan views of the part, including its internal structure. A radiograph is actually a negative. The darkest regions are those that were most exposed when the material being

inspected absorbed the least amount of radiation. Thin parts will be darkest on the radiograph. Porosity will be revealed as small, dark, round spots. Slag is also generally dark, and will look similar to porosity, but will be irregular in its shape. Cracks appear as dark lines. Lack of fusion or underfill will show up as dark spots. Excessive reinforcement on the weld will result in a light region.

Radiographic testing is most effective for detecting volumetric discontinuities: slag and porosity. When cracks are oriented perpendicular to the direction of the radiation source, they may be missed with the RT method. Tight cracks that are parallel to the radiation path have also been overlooked with RT.

Radiographic testing has the advantage of generating a permanent record for future reference. With a "picture" to look at, many people are more confident that the interpretation of weld quality is meaningful. However, reading a radiograph and interpreting the results requires stringent training, so the effectiveness of radiographic inspection depends to a great degree upon the skill of the technician.

Radiographic testing is best suited for inspection of complete joint penetration (CJP) groove welds in butt joints. It is not particularly suitable for inspection of partial joint penetration (PJP) groove welds or fillet welds. When applied to tee and corner joints, the geometric constraints of the applications make RT inspection difficult, and interpretation of the results is highly debatable.

Ultrasonic inspection (UT) relies on the transmission of high frequency sound waves through materials. Solid, discontinuity-free materials will transmit the sound throughout a part in an uninterrupted fashion. A receiver "hears" the sound reflected off of the back surface of the part being inspected. If a discontinuity is contained between the transmitter and the back side of the part, an intermediate signal will be sent to the receiver indicating the presence of this discontinuity. The pulses are displayed on a screen. The magnitude of the signal received from the discontinuity is proportional to the amount of reflected sound. This is indirectly related to the size, type, and orientation of the reflecting surface. The relationship of the signal with respect to the back wall will indicate its location. Ultrasonic inspection is sensitive enough to read discontinuities that are not relevant to the performance of the weld. It is a sophisticated device that is very effective in spotting even small discontinuities.

UT is most sensitive to planar discontinuities, such as cracks, laminations, and non-fusion perpendicular to the direction of sound transmission. Under some conditions, uniformly cylindrical or spherical discontinuities can be overlooked with UT.

Ultrasonic inspection is very effective for examination of CJP groove welds. While UT inspection of PJP groove welds is possible, interpretation of the results can be difficult. UT inspection can be applied to butt, corner, and T-joints, and offers a significant advantage over RT.

A common situation in UT inspection is worth noting because of the problems encountered. In tee and corner joints, with CJP groove welds made from one side and with steel backing attached, the interpretation of results is difficult at best. It is difficult to clearly distinguish between the naturally occurring regions where the backing contacts the adjacent vertical tee or corner joint member and an unacceptable lack of fusion. There is always a signal generated in this area. This of course is the situation that is encountered when steel backing is left in place on a beam-to-column moment connection. To minimize this problem, the steel backing can be removed. This offers two advantages: First, the influence of the backing is obviously eliminated; and secondly, in the process of backing removal, the joint can be backgouged and the root inspected prior to the application of the back weld and the reinforcing fillet weld (FEMA 267).

It is also important to note that when a bottom beam-to-column connection is inspected from the top side of the flange, it is impossible for the operator to scan across the entire width of the beam flange because of the presence of the beam web. This leaves a region in the center of the weld that cannot be UT inspected. Unfortunately, this is also the region that is most difficult for the welder to deposit sound weld metal in, and has been identified as the source of many weld defects. When the beam is joined to a wide flange column, this is also the most severely loaded portion of the weld. Backing removal and subsequent backgouging operations help overcome this UT limitation since it affords the opportunity of visual verification of weld soundness.

11 Arc Welding Safety

Arc welding is a safe occupation when sufficient measures are taken to protect the welder from potential hazards. When these measures are overlooked or ignored, welders can encounter such dangers as electric shock, over-exposure to radiation, fumes and gases, and fire and explosion; any of these can result in fatal injuries. Everyone associated with the welding operation should be aware of the potential hazards and ensure that safe practices are employed. Infractions should be reported to the appropriate responsible authority.

Supplement One is a guide for the proper selection of an appropriate filter or shade for eye protection when directly observing the arc. Supplement Two lists published standards and guidelines regarding safety. Supplement Three consists of a series of precautions covering the major area of potential hazards associated with welding. Supplement Four is a checklist which gives specific instructions to the welder to ensure safe operating conditions.

SUPPLEMENT 1
Guide for Shade Numbers

Operation	Electrode Size 1/32 in. (mm)	Arc Current (A)	Minimum Protective Shade	Suggested ⁽¹⁾ Shade No. (Comfort)
Shielded metal arc welding	Less than 3 (2.5) 3-5 (2.5-4) 5-8 (4-6.4) More than 8 (6.4)	Less than 60	7	—
		60-160	8	10
		160-250	10	12
		250-550	11	14
Gas metal arc welding and flux cored arc weld- ing		Less than 60	7	—
		60-160	10	11
		160-250	10	12
		250-500	10	14
Gas tungsten arc weld- ing		Less than 50	8	10
		50-150	8	12
		150-500	10	14
Air carbon arc cutting	(Light) (Heavy)	Less than 500	10	12
		500-1000	11	14
Plasma arc welding		Less than 20	6	6 to 8
		20-100	8	10
		100-400	10	12
		400-800	11	14
Plasma arc cutting	(Light) ⁽²⁾ (Medium) ⁽²⁾ (Heavy) ⁽²⁾	Less than 300	8	9
		300-400	9	12
		400-800	10	14
Torch brazing		—	—	3 or 4
Torch soldering		—	—	2
Carbon arc welding		—	—	14
	Plate thickness			
	in.	mm		
Gas welding	Under 1/8	Under 3.2		4 or 5
	1/8 to 1/2	3.2 to 12.7		5 or 6
	Over 1/2	Over 12.7		6 or 8
Oxygen cutting	Under 1	Under 25		3 or 4
	1 to 6	25 to 150		4 or 5
	Over 6	Over 150		5 or 6
<p>⁽¹⁾ As a rule of thumb, start with a shade that is too dark to see the weld zone. Then go to a lighter shade which gives sufficient view of the weld zone without going below the minimum. In oxyfuel gas welding or cutting where the torch produces a high yellow light, it is desirable to use a filter lens that absorbs the yellow or sodium line in the visible light of the (spectrum) operation.</p> <p>⁽²⁾ These values apply where the actual arc is clearly seen. Experience has shown that lighter filters may be used when the arc is hidden by the workpiece.</p>				
Data from ANSI/ASC Z49.1-88				

SUPPLEMENT 2
Arc Welding Safety Precautions



WARNING

ARC WELDING can be hazardous.

PROTECT YOURSELF AND OTHERS FROM POSSIBLE SERIOUS INJURY OR DEATH. KEEP CHILDREN AWAY. PACEMAKER WEARERS SHOULD CONSULT WITH THEIR DOCTOR BEFORE OPERATING.

Read and understand the following safety highlights. For additional safety information it is strongly recommended that you purchase a copy of "Safety in Welding & Cutting - ANSI Standard Z49.1" from the American Welding Society, P.O. Box 351040, Miami, Florida 33135 or CSA Standard W117.2-1974. A Free copy of "Arc Welding Safety" booklet E205 is available from the Lincoln Electric Company, 22801 St. Clair Avenue, Cleveland, Ohio 44117-1199.

BE SURE THAT ALL INSTALLATION, OPERATION, MAINTENANCE, AND REPAIR PROCEDURES ARE PERFORMED ONLY BY QUALIFIED INDIVIDUALS.



ELECTRIC SHOCK can kill.

- 1.a. The electrode and work (or ground) circuits are electrically "hot" when the welder is on. Do not touch these "hot" parts with your bare skin or wet clothing. Wear dry, hole-free gloves to insulate hands.
- 1.b. Insulate yourself from work and ground using dry insulation. Make certain the insulation is large enough to cover your full area of physical contact with work and ground.

In addition to the normal safety precautions, if welding must be performed under electrically hazardous conditions (in damp locations or while wearing wet clothing; on metal structures such as floors, gratings or scaffolds; when in cramped positions such as sitting, kneeling or lying, if there is a high risk of unavoidable or accidental contact with the workpiece or ground) use the following equipment:
 - Semiautomatic DC Constant Voltage (Wire) Welder.
 - DC Manual (Stick) Welder.
 - AC Welder with Reduced Voltage Control.
- 1.c. In semiautomatic or automatic wire welding, the electrode, electrode reel, welding head, nozzle or semiautomatic welding gun are also electrically "hot".
- 1.d. Always be sure the work cable makes a good electrical connection with the metal being welded. The connection should be as close as possible to the area being welded.
- 1.e. Ground the work or metal to be welded to a good electrical (earth) ground.
- 1.f. Maintain the electrode holder, work clamp, welding cable and welding machine in good, safe operating condition. Replace damaged insulation.
- 1.g. Never dip the electrode in water for cooling.
- 1.h. Never simultaneously touch electrically "hot" parts of electrode holders connected to two welders because voltage between the two can be the total of the open circuit voltage of both welders.
- 1.i. When working above floor level, use a safety belt to protect yourself from a fall should you get a shock.
- 1.j. Also see Items 4.c. and 6.



ARC RAYS can burn.

- 2.a. Use a shield with the proper filter and cover plates to protect your eyes from sparks and the rays of the arc when welding or observing open arc welding. Headshield and filter lens should conform to ANSI Z87.1 standards.
- 2.b. Use suitable clothing made from durable flame-resistant material to protect your skin and that of your helpers from the arc rays.
- 2.c. Protect other nearby personnel with suitable non-flammable screening and/or warn them not to watch the arc nor expose themselves to the arc rays or to hot spatter or metal.



FUMES AND GASES can be dangerous.

- 3.a. Welding may produce fumes and gases hazardous to health. Avoid breathing these fumes and gases. When welding, keep your head out of the fume. Use enough ventilation and/or exhaust at the arc to keep fumes and gases away from the breathing zone. **When welding with electrodes which require special ventilation such as stainless or hard facing (see instructions on container or MSDS) or on galvanized, lead or cadmium plated steel and other metals which produce toxic fumes, keep exposure as low as possible and below Threshold Limit Values (TLV) using local exhaust or mechanical ventilation. In confined spaces or in some circumstances, outdoors, a respirator may be required.**
- 3.b. Do not weld in locations near chlorinated hydrocarbon vapors coming from degreasing, cleaning or spraying operations. The heat and rays of the arc can react with solvent vapors to form phosgene, a highly toxic gas, and other irritating products.
- 3.c. Shielding gases used for arc welding can displace air and cause injury or death. Always use enough ventilation, especially in confined areas, to insure breathing air is safe.
- 3.d. Read and understand the manufacturer's instructions for this equipment and the consumables to be used, including the material safety data sheet (MSDS) and follow your employer's safety practices. MSDS forms are available from your welding distributor or from the manufacturer.
- 3.e. Also see item 7b.



WELDING SPARKS can cause fire or explosion.

- 4.a. Remove fire hazards from the welding area. If this is not possible, cover them to prevent the welding sparks from starting a fire. Remember that welding sparks and hot materials from welding can easily go through small cracks and openings to adjacent areas. Avoid welding near hydraulic lines. Have a fire extinguisher readily available.
- 4.b. Where compressed gases are to be used at the job site, special precautions should be used to prevent hazardous situations. Refer to "Safety in Welding and Cutting" (ANSI Standard Z49.1) and the operating information for the equipment being used.
- 4.c. When not welding, make certain no part of the electrode circuit is touching the work or ground. Accidental contact can cause overheating and create a fire hazard.
- 4.d. Do not heat, cut or weld tanks, drums or containers until the proper steps have been taken to insure that such procedures will not cause flammable or toxic vapors from substances inside. They can cause an explosion even though they have been "cleaned." For information purchase "Recommended Safe Practices for the Preparation for Welding and Cutting of Containers and Piping That Have Held Hazardous Substances", AWS F4.1-80 from the American Welding Society (see address above).
- 4.e. Vent hollow castings or containers before heating, cutting or welding. They may explode.

4.f. Sparks and spatter are thrown from the welding arc. Wear oil free protective garments such as leather gloves, heavy shirt, cuffless trousers, high shoes and a cap over your hair. Wear ear plugs when welding out of position or in confined places. Always wear safety glasses with side shields when in a welding area.

4.g. Connect the work cable to the work as close to the welding area as practical. Work cables connected to the building framework or other locations away from the welding area increase the possibility of the welding current passing through lifting chains, crane cables or other alternate circuits. This can create fire hazards or overheat lifting chains or cables until they fail.

4.h. Also see item 7c.



CYLINDER may explode if damaged.

5.a. Use only compressed gas cylinders containing the correct shielding gas for the process used and properly operating regulators designed for the gas and pressure used. All hoses, fittings, etc. should be suitable for the application and maintained in good condition.

5.b. Always keep cylinders in an upright position securely chained to an undercarriage or fixed support.

5.c. Cylinders should be located:

- Away from areas where they may be struck or subjected to physical damage.
- A safe distance from arc welding or cutting operations and any other source of heat, sparks, or flame.

5.d. Never allow the electrode, electrode holder or any other electrically "hot" parts to touch a cylinder.

5.e. Keep your head and face away from the cylinder valve outlet when opening the cylinder valve.

5.f. Valve protection caps should always be in place and hand tight except when the cylinder is in use or connected for use.

5.g. Read and follow the instructions on compressed gas cylinders, associated equipment, and CGA publication P-1, "Precautions for Safe Handling of Compressed Gases in Cylinders," available from the Compressed Gas Association 1235 Jefferson Davis Highway, Arlington, VA 22202.



FOR ELECTRICALLY powered equipment.

6.a. Turn off input power using the disconnect switch at the fuse box before working on the equipment.

6.b. Install equipment in accordance with the U.S. National Electrical Code, all local codes and the manufacturer's recommendations.

6.c. Ground the equipment in accordance with the U.S. National Electrical Code and the manufacturer's recommendations.



FOR ENGINE powered equipment.

7.a. Turn the engine off before troubleshooting and maintenance work unless the maintenance work requires it to be running.



7.b. Operate engines in open, well-ventilated areas or vent the engine exhaust fumes outdoors.



7.c. Do not add the fuel near an open flame welding arc or when the engine is running. Stop the engine and allow it to cool before refueling to prevent spilled fuel from vaporizing on contact with hot engine parts and igniting. Do not spill fuel when filling tank. If fuel is spilled, wipe it up and do not start engine until fumes have been eliminated.



7.d. Keep all equipment safety guards, covers and devices in position and in good repair. Keep hands, hair, clothing and tools away from V-belts, gears, fans and all other moving parts when starting, operating or repairing equipment.

7.e. In some cases it may be necessary to remove safety guards to perform required maintenance. Remove guards only when necessary and replace them when the maintenance requiring their removal is complete. Always use the greatest care when working near moving parts.

7.f. Do not put your hands near the engine fan. Do not attempt to override the governor or idler by pushing on the throttle control rods while the engine is running.

7.g. To prevent accidentally starting gasoline engines while turning the engine or welding generator during maintenance work, disconnect the spark plug wires, distributor cap or magneto wire as appropriate.



7.h. To avoid scalding, do not remove the radiator pressure cap when the engine is hot.



ELECTRIC AND MAGNETIC FIELDS may be dangerous

8.a. Electric current flowing through any conductor causes localized Electric and Magnetic Fields (EMF). Welding current creates EMF fields around welding cables and welding machines.

8.b. EMF fields may interfere with some pacemakers, and welders having a pacemaker should consult their physician before welding.

8.c. Exposure to EMF fields in welding may have other health effects which are now not known.

8d. All welders should use the following procedures in order to minimize exposure to EMF fields from the welding circuit:

8.d.1. Route the electrode and work cables together - Secure them with tape when possible.









8.d.2. Never coil the electrode lead around your body.

8.d.3. Do not place your body between the electrode and work cables. If the electrode cable is on your right side, the work cable should also be on your right side.

8.d.4. Connect the work cable to the workpiece as close as possible to the area being welded.

8.d.5. Do not work next to welding power source.

SUPPLEMENT 3 Welding Safety Checklist

Hazard	Factors to Consider	Precaution Summary
<p>Electric shock can kill</p> 	<ul style="list-style-type: none"> • Wetness • Welder in or on workpiece • Confined space • Electrode holder and cable insulation 	<ul style="list-style-type: none"> • Insulate welder from workpiece and ground using <i>dry</i> insulation. Rubber mat or dry wood. • Wear <i>dry, hole-free</i> gloves. (Change as necessary to keep dry.) • Do not touch electrically "hot" parts or electrode with bare skin or wet clothing. • If wet area and welder cannot be insulated from workpiece with dry insulation, use a semiautomatic, constant-voltage welder or stick welder with voltage reducing device. • Keep electrode holder and cable insulation in good condition. Do not use if insulation damaged or missing.
<p>Fumes and gases can be dangerous</p> 	<ul style="list-style-type: none"> • Confined area • Positioning of welder's head • Lack of general ventilation • Electrode types, i.e., manganese, chromium, etc. See MSDS • Base metal coatings, galvanize, paint 	<ul style="list-style-type: none"> • Use ventilation or exhaust to keep air breathing zone clear, comfortable. • Use helmet and positioning of head to minimize fume in breathing zone. • Read warnings on electrode container and material safety data sheet (MSDS) for electrode. • Provide additional ventilation/exhaust where special ventilation requirements exist. • Use special care when welding in a confined area. • Do not weld unless ventilation is adequate.
<p>Welding sparks can cause fire or explosion</p> 	<ul style="list-style-type: none"> • Containers which have held combustibles • Flammable materials 	<ul style="list-style-type: none"> • Do not weld on containers which have held combustible materials (unless strict AWS F4.1 procedures are followed). Check before welding. • Remove flammable materials from welding area or shield from sparks, heat. • Keep a fire watch in area during and after welding. • Keep a fire extinguisher in the welding area. • Wear fire retardant clothing and hat. Use earplugs when welding overhead.
<p>Arc rays can burn eyes and skin</p> 	<ul style="list-style-type: none"> • Process: gas-shielded arc most severe 	<ul style="list-style-type: none"> • Select a filter lens which is comfortable for you while welding. • Always use helmet when welding. • Provide non-flammable shielding to protect others. • Wear clothing which protects skin while welding.
<p>Confined space</p> 	<ul style="list-style-type: none"> • Metal enclosure • Wetness • Restricted entry • Heavier than air gas • Welder inside or on workpiece 	<ul style="list-style-type: none"> • Carefully evaluate adequacy of ventilation especially where electrode requires special ventilation or where gas may displace breathing air. • If basic electric shock precautions cannot be followed to insulate welder from work and electrode, use semiautomatic, constant-voltage equipment with cold electrode or stick welder with voltage reducing device. • Provide welder helper and method of welder retrieval from outside enclosure.
<p>General work area hazards</p>   	<ul style="list-style-type: none"> • Cluttered area • Indirect work (welding ground) connection • Electrical equipment • Engine-driven equipment • Gas cylinders 	<ul style="list-style-type: none"> • Keep cables, materials, tools neatly organized. • Connect work cable as close as possible to area where welding is being performed. Do <i>not</i> allow alternate circuits through scaffold cables, hoist chains, ground leads. • Use only double insulated or properly grounded equipment. • Always disconnect power to equipment before servicing. • Use in only open, well ventilated areas. • Keep enclosure complete and guards in place. • See Lincoln service shop if guards are missing. • Refuel with engine off. • If using auxiliary power, OSHA may require GFI protection or assured grounding program (or isolated windings if less than 5KW). • Never touch cylinder with the electrode. • Never lift a machine with cylinder attached. • Keep cylinder upright and chained to support.

SUPPLEMENT 4

References

ANSI/AWS D1.1-98 Structural Welding Code - Steel.
The American Welding Society, 1998.

AWS A3.0-94 Standard Welding Terms and Definitions.
The American Welding Society, 1994.

AWS A5.17-97 Specification for Carbon Steel Electrodes and Fluxes for Submerged Arc Welding.
The American Welding Society, 1997.

AWS A5.1-91 Specification for Carbon Steel Electrodes for Shielded Metal Arc Welding.
The American Welding Society, 1991.

AWS A5.20-95 Specification for Carbon Steel Electrodes for Flux Cored Arc Welding.
The American Welding Society, 1995.

AWS A5.23-97 Specification for Low Alloy Steel Electrodes and Fluxes for Submerged Arc Welding.
The American Welding Society, 1997.

AWS A5.29-98 Specification for Low Alloy Electrodes for Flux Cored Arc Welding.
The American Welding Society, 1998.

AWS A5.5-96 Specification for Low Alloy Electrodes for Shielded Metal Arc Welding.
The American Welding Society, 1996.

AWS B2.1 Welding Procedure Specifications.
The American Welding Society, 1999.

AWS Structural Welding Committee Position Statement on Northridge Earthquake Welding Issues.
The American Welding Society, November 10, 1995.

Boniszewski, T. *Self-Shielded Arc Welding.*
Cambridge: Abington, 1992.

Interim Guidelines: Evaluation, Repair, Modification and Design of Welded Steel Moment Frame Structures (FEMA 267). Federal Emergency Management Agency, August 1995.

Load & Resistance Factor Design.
The American Institute of Steel Construction, 1999.

The Procedure Handbook of Arc Welding. 13th Edition.
The James F. Lincoln Arc Welding Foundation, 1995.

Welding Handbook, Vol. 1 - Welding Technology.
The American Welding Society, 1987.