

TABLE *of* CONTENTS



Chapter 1	Introduction to Power Motion Products	1-1
Chapter 2	Spur Gears	2-1
Chapter 3	Helical Gears	3-1
Chapter 4	Worm and Worm Gears	4-1
Chapter 5	Bevel and Miter Gears	5-1
Chapter 6	700 Series Worm Gear Speed Reducers	6-1
Chapter 7	800 Series Helical Speed Reducers	7-1
Chapter 8	Introduction to Ratiotrol	8-1
Chapter 9	AC Inverters	9-1
Chapter 10	Centric Overload Release Clutches	10-1

INTRODUCTION *to* POWER MOTION PRODUCTS

1



The Boston Gear Story

Established in Charlestown, Massachusetts Boston Gear was founded by none other than the man who invented the calculator - George Grant. Grant headed the business from 1877 to 1891, when it was sold to Frank Burgess, a businessman with one overriding goal: to provide accuracy, economy, and despatch, or, in today's marketing vernacular, quality, price, and service - and indeed, those are the hallmarks upon which Boston Gear was built.

Since then, the Boston Gear story has been measured in one milestone after another, including:

- our inaugural product catalog in 1892;
- the first catalog to include complementary parts, such as pulleys, u-joints, sprockets, and shafts was printed in 1899;
- our special "horseless carriage catalog" published in 1900 for that newfangled invention - the car
- the Thanksgiving Eve, 1909, Boston Gear Works fire in Quincy, Massachusetts, in which everything was destroyed;
- the company's reopening just months later in February 1910;
- the early-1960s development of a line of electrical motion control devices, which has since been expanded into a comprehensive selection of AC and DC motor controllers, motors and other accessories;
- the advent of fluid power products, bringing the total number of products available through Boston Gear to over 30,000;
- the 1968 introduction of the modular worm gear speed reducer - a first in the industry, and a product that provides a long life of smooth, efficient, trouble-free performance;
- the establishment of the Louisburg, NC, speed reducer manufacturing facility in the 1970s;
- the 1975 venture into on-line communication with distribution, which resulted in over 14,000 miles of leased telephone lines during the two subsequent years alone;
- the company's move to Quincy, MA, in 1977;
- completion of the state-of-the-art Florence, KY, National Distribution Center in 1980;
- the 1983 introduction of the in-line helical and right angle helical/bevel gear speed reducers;
- the acquisition of Ferguson Gear in 1989, at which time Boston Gear transferred the machinery for the manufacture of open gearing and coupling products to Ferguson's Charlotte, North Carolina, location;
- our 1996 acquisition by the Colfax Corporation;
- and our 2000 merger with Warner Electric



Welcome to *Power Transmission 101* (also known as Gearology) – a course designed to teach you everything you need to know about the Boston Gear family of power transmission drives.

Why a comprehensive course about power transmission?

For two very good reasons: First, the more you know about power transmission, the more you'll be able to help your customers select the right products for their applications. Second, there's a potential sale to be made every place a shaft turns! And in American industry, that means virtually everywhere – from a giant automobile manufacturing plant in the Midwest to a small mom-and-pop bakery on the Rhode Island shore.

Boston Gear's *Power Transmission 101* course won't make you a mechanical engineer. It will, however, provide you with the basic knowledge and confidence to solve most of your customers' and prospects' power transmission needs – and problems. As a result, you will be “adding value” for your customers and setting the stage to increase your sales. And that's a win-win for everyone.

On that note, let's get familiar with some of the basics of power transmission – keeping in mind that you should have a complete set of Boston Gear catalogs nearby for quick reference.

There are a number of variables to consider when selecting a power transmission drive for a given application. The most important of these variables are:

- Horsepower or torque to be transmitted
- Required speeds (revolutions per minute, rpm)
- Duty cycle

As a first step in the power transmission drive train selection process, you must determine what these variables are by conferring with your customer or prospect.

Boston Gear makes many types of gears for use in open and enclosed gear drives, each of which will be discussed in greater detail in subsequent chapters. To help prepare you for these lessons, it is important that you become familiar with the terminology used in the power transmission industry (and included in the Glossary Sections at the end of certain chapters. Don't be concerned if you don't become instantly fluent in the language of Gearology. By the time you complete *Power Transmission 101*, you'll be speaking like a real “pro.”

THE DRIVE SYSTEM

There are many Boston Gear components in a complete power transmission drive, each of which will be discussed in detail later on. With that in mind, let's take a quick look at the components you can "package" for any given drive application.

BEARINGS

A bearing is a mechanical device that supports the moving parts of a machine. Its primary purpose is to reduce friction. Bearings are made to support radial loads, thrust loads, or combined radial-thrust loads. They may be categorized into two general classes, each with two sub-types:

- | | |
|---|--|
| <p>1) Plain</p> <p>a) Cylindrical</p> <p>b) Thrust</p> | <p>2) Anti-Friction Bearings</p> <p>a) Ball bearing</p> <p>b) Roller bearings</p> |
|---|--|



Fig 1.1
Bear-N-Bronz
Plain Cylindrical Bearings



Fig 1.2
Bost-Bronz Thrust Bearings



Fig 1.3
Bost-Bronz Flanged Bearings

Boston Gear sells two types of **plain bearings**: *Bear-N-Bronz*, made from a cast, solid bronze material, and *Bost-Bronz*, made from a porous bronze, oil impregnated type of bearing material. *Bear-N-Bronz* bearings are available as plain bearings, cored bars or solid bars. *Bost-Bronz* bearings are available as plain bearings (also known as sleeve bearings), flanged bearings, thrust-bearings, cored bars, solid bars and plate stock. (See *Figures 1.1, 1.2, 1.3*)

ANTI-FRICTION BEARINGS

Boston Gear’s stock line of **anti-friction bearings** is confined to ball bearings for radial loads and thrust loads. The radial line is stocked in precision ground and semi-ground models. The thrust line is stocked in ground steel and stainless steel. (See Figures 1.5, 1.6)



Fig 1.5, Radial Bearing

PILLOW BLOCKS

A pillow block supports a shaft directly on its bore. It has a sleeve or anti-friction bearing mounted on its bore which supports the shaft. The simplest type of pillow block is the *split cast iron or brass model*, which, as shown below, (See Figure 1.7) supports a shaft directly in its bore. Another type of Boston Gear pillow block supports the shaft in a *bronze sleeve bearing* that has been assembled in its bore. (See Figure 1.8)

PILLOW BLOCKS – ANTI-FRICTION BEARING

An anti-friction bearing pillow block consists of a ball or roller bearing with its spherical outside diameter mounted in a cast iron housing. The spherical shape of the bearing’s outside diameter will accommodate some degree of shaft misalignment. For this reason, they are often referred to as “self-aligning”. (See Figure 1.9)



Fig 1.6, Thrust Bearing

FLANGED CARTRIDGES

A flanged cartridge consists of a ball or roller bearing with spherical outside diameter mounted in a cast iron housing. The spherical shape of the bearing’s outside diameter will accommodate some degree of shaft misalignment. They, too, are often referred to as “self-aligning”. (See Figure 1.10)

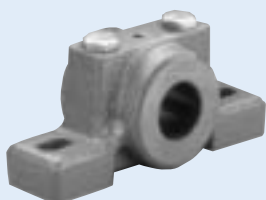

Fig 1.7, Split Cast Iron Pillow Block (no bearing)

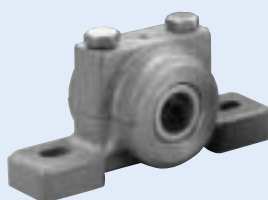

Fig 1.8, Split Cast Iron Pillow Block with Bost-Bronz bearing

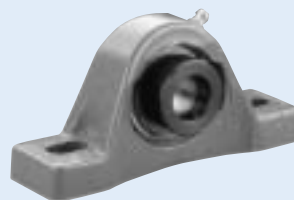

Fig 1.9, Radial Bearing

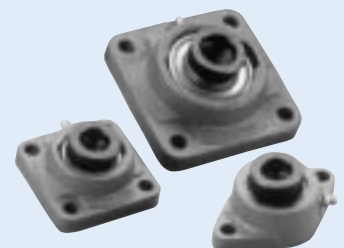

Fig 1.10, Cast Iron Flange Bearings

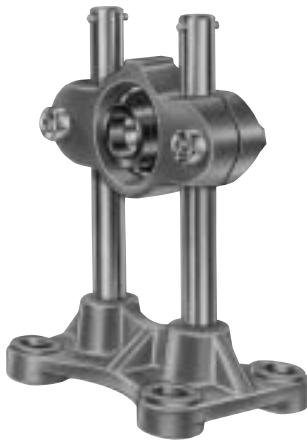

Fig 1.11, Adjustable Shaft Support



Fig 1.12, Sleeve Type
(straight-through) Coupling



Fig 1.13, Multi-Jaw
(light-duty) Coupling



Fig 1.14, FC Series
Three-Jaw Insert-Type Couplings



Fig 1.15,
Bost-Flex Series

SHAFT SUPPORTS

An adjustable shaft support consists of a ball bearing with spherical outside diameter and a cast iron housing or carrier, two support shafts and a base. The spherical shape of the ball bearing's outside diameter will accommodate some degree of shaft misalignment. Thus, like flanged cartridges, they, too, are often referred to as "self-aligning". (See Figure 1.11)

COUPLINGS

Couplings are used to connect two pieces of shafting. While there are many types of couplings, Boston Gear carries three basic types that will take care of the great majority of applications:

- Sleeve couplings (See Figure 1.12)
- Multi-Jaw couplings (primarily for light duty) (See Figure 1.13)
- Three Jaw/Insert couplings (See Figure 1.14)

A few additional notes about Boston Gear couplings:

- Three-Jaw Insert couplings are used to provide quieter running and to minimize vibration.
- Bost-Flex, light duty couplings have spider-ring design with a special elastomer insert. (See Figure 1.15)

Boston Gear FC Series couplings are available with three types of inserts for specific conditions: (See Figure 1.16)

- Oil Impregnated Bost-Bronz Insert
- Oil Resistant Synthetic Rubber Insert
- Polyurethane Insert

Fig 1.16

**Oil Impregnated
Bost-Bronz
Insert**



Recommended for
high torque loads,
particularly at
slower speeds.

**Oil Resistant
Synthetic Rubber
Insert**



Recommended
where quietness
is desired.

**Polyurethane
Insert**



Recommended
where moderate to
heavy shock loads
are encountered.

A SPUR GEAR is cylindrical in shape, with teeth on the outer circumference that are straight and parallel to the axis (hole). There are a number of variations of the basic spur gear, including pinion wire, stem pinions, rack and internal gears. (See Figure 1.17)

PINION WIRE is a long wire or rod that has been drawn through a die so that gear teeth are cut into its surface. It can be made into small gears with different face widths, hubs, and bores. Pinion wire is stocked in 4 ft. lengths. (See Figure 1.18)

STEM PINIONS are bore-less spur gears with small numbers of teeth cut on the end of a ground piece of shaft. They are especially suited as pinions when large reductions are desired. (See Figure 1.19)

RACK are yet another type of spur gear. Unlike the basic spur gear, racks have their teeth cut into the surface of a straight bar instead of on the surface of a cylindrical blank. Rack is sold in two, four and six foot lengths, depending on pitch, which you will learn about starting in chapter 2. (See Figure 1.20)

INTERNAL GEARS have their teeth cut parallel to their shafts like spur gears, but they are cut on the inside of the gear blank. (See Figure 1.21)



Fig 1.17, Spur Gear Set

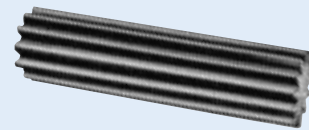

Fig 1.18, Pinion Wire

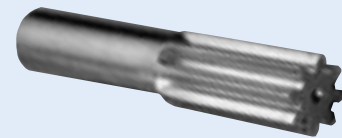

Fig 1.19, Stem Pinion

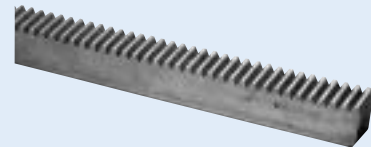

Fig 1.20, Rack

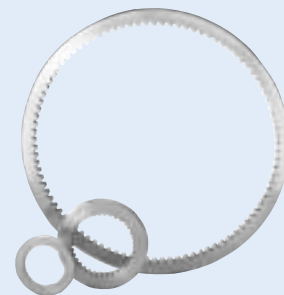

Fig 1.21, Internal Gear



Fig 1.22, Left Hand



Fig 1.23, Right Hand



Fig 1.24, Opposite Hand



Fig 1.25, Same Hand



Fig 1.26, Straight Tooth



Fig 1.27, Spiral Tooth



Fig 1.28, Straight Tooth



Fig 1.29, Spiral Tooth

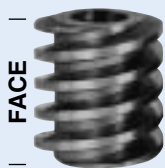

Fig 1.30A, Right Hand Worm



Fig 1.30B, Worm Gear

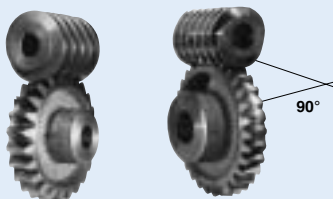

Fig 1.30
Worm and Gear Single Thread Worm and Gear Four Thread

HELICAL GEARS

A helical gear is similar to a spur gear except that the teeth of a helical gear are cut at an angle (known as the helix angle) to the axis (or hole). Helical gears are made in both right and left hand configurations. Opposite hand helical gears run on parallel shafts. Gears of the same hand operate with shafts at 90-degrees. (See Figure 1.22, 1.23, 1.24, 1.25)

BEVEL GEARS

A bevel gear is shaped like a section of a cone and usually operates on shafts at 90-degrees. The teeth of a bevel gear may be straight or spiral. If they are spiral, the pinion and gear must be of opposite hand in order for them to run together. Bevel gears, in contrast to miter gears (see below), provide a ratio (reduce speed) so the pinion always has fewer teeth. (See Figure 1.26, 1.27)

MITER GEARS

Miter gears are identical to bevel gears except that in a miter gear set, both gears always have the same number of teeth. Their ratio, therefore, is always 1 to 1. As a result, miter gears are not used when an application calls for a change of speed. (See Figure 1.28, 1.29)

WORMS & WORM GEARS

WORM Worms are a type of gear with one or more cylindrical threads or "starts" (that resemble screw threads) and a face that is usually wider than its diameter. A worm gear has a center hole (bore) for mounting the worm on a shaft. (See Figure 1.30A)

WORM GEARS – like worms – also are usually cylindrical and have a center hole for mounting on a shaft. The diameter of a worm gear, however, is usually much greater than the width of its face. Worm gears differ from spur gears in that their teeth are somewhat different in shape, and they are always formed on an angle to the axis to enable them to mate with worms. (See Figure 1.30B)

Worms and worm gears work in sets, rotating on shafts at right angles to each other, in order to transmit motion and power at various speeds and speed ratios. In worm and worm gear sets, both the worm and worm gear are of the same hand. (Because right-hand gearing is considered standard, right-hand sets will always be furnished unless otherwise specified.) (See Figure 1.30)

UNIVERSAL JOINTS

Universal joints are used to connect shafts with angular misalignment. Boston Gear sells two basic types of universal joints for a wide variety of applications:

- Center block and pin type (See *Figure 1.31*)
 - "J" Series – medium carbon alloy steel
 - "JS" Series – stainless steel
 - All stocked with solid or bored hubs
- BOS-trong (See *Figure 1.32*)
 - Uses needle bearings for heavier duty applications
 - Made in two basic sizes with a variety of hub diameters and shapes
 - Have keyway and set screw

It's almost time to begin Power Transmission 101...

Now that we have learned about some of the stock components – gears, bearings, pillow blocks, couplings, and universal joints – that make up a Boston Gear power transmission drive or system, it is time to move on to a more detailed look at these and many more system components.

While the information might seem difficult at first, your understanding of the material will be greatly enhanced if you actively refer to your *Glossary of Terms* – and your Boston Gear catalogs – along the way.

One of the most helpful sections in the catalogs is the *Index to Catalog Numbers*, found at the back of the Bearings and Gears catalogs. Here you will find an identification number for every product in the catalogs – listed in both numerical and alphabetical order – along with the page number where the product appears in the catalog. When anyone gives you a catalog number, or when you need to know the specifications of a gear, just check the number stamped on the gear (or its nameplate) and then check out the index for the corresponding catalog page number. It's that easy.

In checking the catalogs, you will also note that there are many other components (such as enclosed gear drives and a complete line of variable speed control systems) that you can sell as part of a complete Boston Gear power transmission "package." All of these components will be covered in detail later in our Gearology course.

So let's get started, beginning with the most basic of gears: the spur gear.



*Fig 1.31,
"J" and "JS" Series Machine-Finished
Universal Joints*

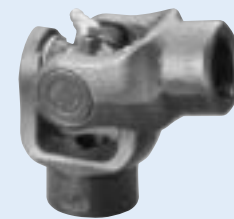

*Fig 1.32,
BOS- trong Heavy-Duty
Universal Joint*

Quiz

CLICK HERE or visit <http://www.bostgear.com/quiz> to take the quiz

SPUR GEARS

2



Now that you've been introduced to both Boston Gear and some of the basics of our Gearology course – which we like to call *Power Transmission 101* – let's look closely at the most common of all gears – the **spur gear**.

The spur gear is the most basic mechanical power transmission product sold by Boston Gear. In fact, there are applications for these gears almost “every place a shaft turns”. That's why we begin our course with a detailed look at the spur gear family and how spur gears work to “get the job done” for so many of our customers.

As you will remember from our introduction, a gear (no matter what type) is essentially a toothed wheel or cylinder that works in tandem with another gear (or gears) to transmit motion, or to change speed or direction. In a spur gear, the teeth, which are on the outer surface of the cylinder, are straight and parallel to the hole (or axis) so when two come together – mesh – they do so in the same plane. (See *Figure 2.1*)

As a result of how they meet, spur gears can increase or decrease the speed or torque of whatever they are “moving”.

COMMON APPLICATIONS: Spur gears are used to move virtually anything that can move, from mixers, blenders, copy machines, textile machinery and ice machines to the NASA space program.

BACK TO BASICS: In any pair of gears, the larger gear will move more slowly than the smaller gear, but it will move with more torque. Thus, the bigger the size difference between two spur gears, the greater the difference in speed and torque.

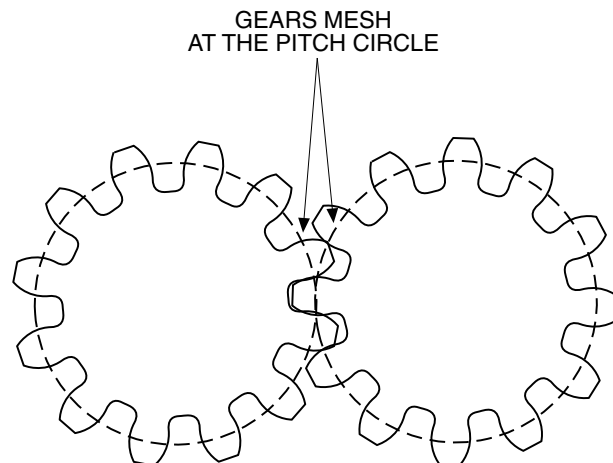

Figure 2.1

THE BOSTON GEAR LINE

As we noted in Chapter 1, there are five (5) types of spur gears: basic, pinion wire, stem pinions, rack, and internal.

THE DIAMETRAL PITCH SYSTEM

One of the first steps in addressing a customer's needs is to determine what size spur gears are needed for a particular application. At Boston Gear, all standard stock spur gears are made according to the *diametral pitch system*, a sizing system we will get to shortly. But before we do, it is helpful to know the meaning of several terms that are commonly used in the gear industry.

Diametral Pitch: *the ratio of the number of teeth to the pitch diameter. (See Figure 2.2, 2.2B)*

Pitch Circle: *the imaginary circle that comes in contact with the imaginary circle of another gear when the two are in mesh. (See Figure 2.2A)*

Pitch Diameter: *the diameter of the pitch circle (See Figure 2.2B)*

Tooth dimensions are important because they provide valuable information when quoting customer gearing.

CATALOG CHECK! The complete line of Boston Gear spur gears is featured in the Gears catalog.

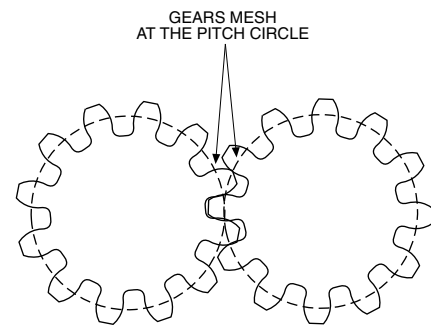

Figure 2.2A

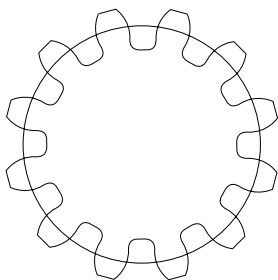

Figure 2.2, A gear with 12 teeth and a 1" Pitch Diameter is 12 Pitch.

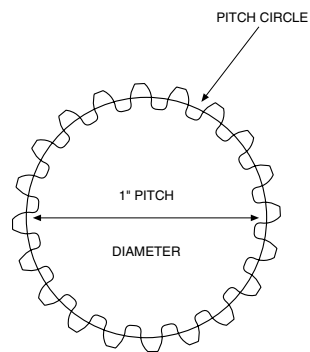

Figure 2.2B, A gear with 20 teeth and a 1" Pitch Diameter is 20 Pitch.

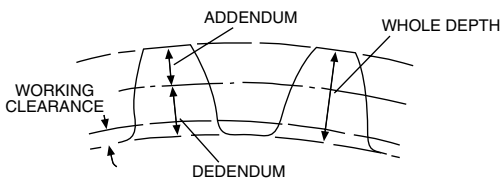

Figure 2.2C

The following terms are used when describing the dimensions of a gear tooth:

Addendum: the distance from the top of a tooth to the pitch circle. (See Figure 2.2C)

Dedendum: the distance from the pitch circle to the root circle. It equals the addendum + the working clearance. (See Figure 2.2C)

Whole Depth: the distance from the top to the bottom of the gear tooth.

Working Depth: the total depth of a tooth space. It is equal to the addendum + the dedendum (or the working depth + the variance).

Working Clearance: the distance from the working depth to the root circle. (See Figure 2.2C)

As noted above, spur gears are measured according to their *diametral pitch* – the number of teeth per inch of pitch diameter.

Example: A gear with a 1" pitch diameter and 12 teeth is a 12-pitch gear. (See Figure 2.2D)

Example: A gear with a 1" pitch diameter and 20 teeth is a 20-pitch gear. (See Figure 2.2E)

Example: A gear with a 1-1/2" pitch diameter and 72 teeth is a 48-pitch gear ($72 \div 1.5$). (See Figure 2.2F)

Easy, right? Now let's look at other important features of spur gears.

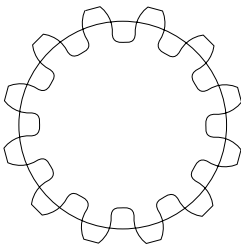

Figure 2.2D, A gear with 12 teeth and a 1" Pitch Diameter is 12 Pitch.

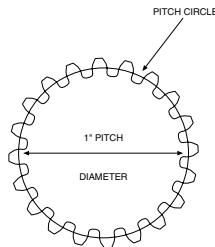

Figure 2.2E, A gear with 20 teeth and a 1" Pitch Diameter is 20 Pitch.



Figure 2.2F, A gear with 72 teeth and a 1-1/2" Pitch Diameter is 48 Pitch.

PRESSURE ANGLE

Pressure angle (also referred to as “tooth shape”) is the angle at which the pressure from the tooth of one gear is passed on to the tooth of another gear. Spur gears come in two pressure angles: 14 1/2° and 20°. (See Figure 2.4)

- The **14 1/2° pressure angle** is the original standard tooth shape. It is still widely used today. (See Figure 2.4A)
- The new and improved **20° pressure angle** tooth shape is a stronger and better tooth because of its wider base, especially on pinion gears with small numbers of teeth. (See Figure 2.4B)

IMPORTANT! 14-1/2° pressure angle gears will not run with 20° pressure angles gears – and vice versa!

CIRCULAR PITCH

Sometimes spur gears are measured according to their *circular pitch*. Simply put, circular pitch is the distance – measuring along the pitch circle or pitch line – from any point on a gear tooth to the *corresponding* point on the next tooth. It is also equal to the circumference of the pitch circle divided by the total number of teeth on the gear. (See Figure 2.5)

Example: 5" circumference ÷ 20 teeth = .25 circular pitch

REMEMBER THIS! Even though Boston Gear spur gears are always cataloged according to their diametral pitch, it is always possible – and easy – to figure out the circular pitch.

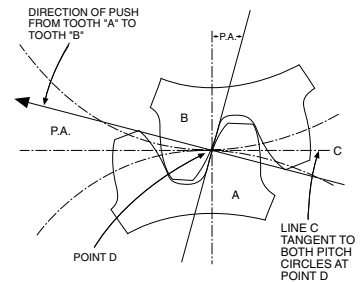

Figure 2.4

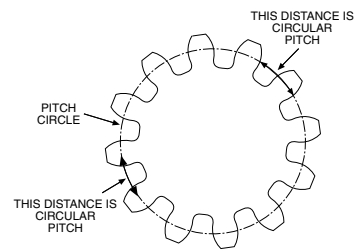

Figure 2.5

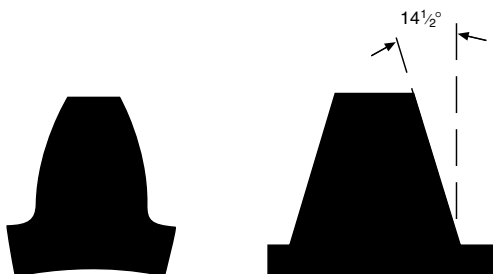

Figure 2.4A,
14-1/2° PRESSURE ANGLE
GEARS are black in the
Boston Gear Catalog.

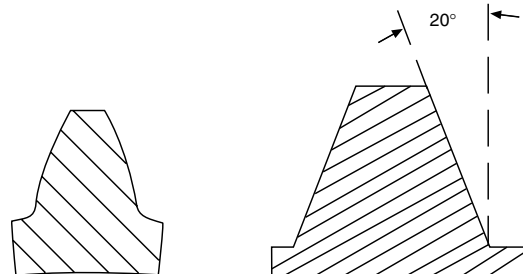

Figure 2.4B,
20° PRESSURE ANGLE GEARS
are shaded in the
Boston Gear Catalog.

CATALOG CHECK!
Average backlash
figures for our entire
line of stock spur
gears are listed in
the Engineering
section of your
Boston Gear
catalogs.

Are you with us so far? Good. Now let's continue with our lesson by looking at some additional terms commonly used in the industry. Don't be discouraged if some of the information seems difficult at first. Over time, you will become an old pro at speaking the language of "gearology."

BACKLASH is the distance (spacing) between two "mating" gears measured at the back of the driver on the pitch circle. Backlash, which is purposely built in, is very important because it helps prevent noise, abnormal wear and excessive heat while providing space for lubrication of the gears. (See Figure 2.6)

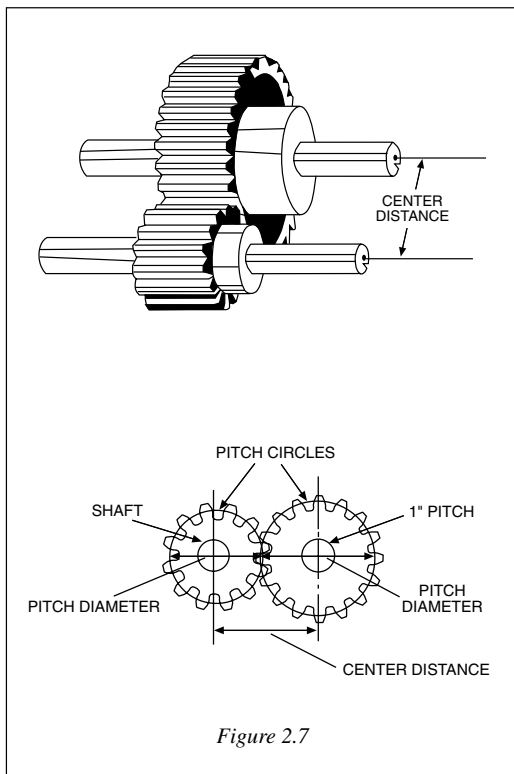

Figure 2.7

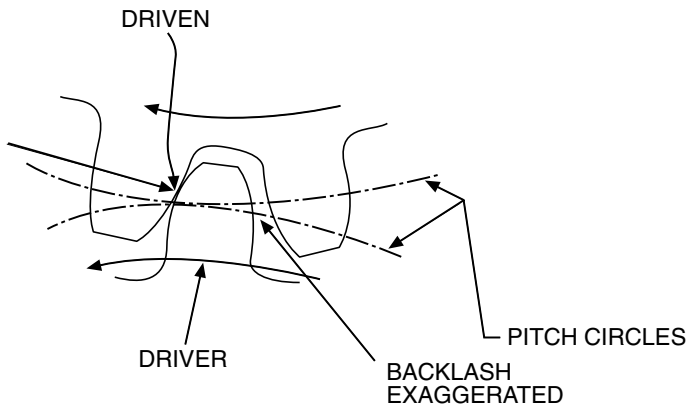

Figure 2.6

CENTER DISTANCE is the distance between the center of the shaft of one spur gear to the center of the shaft of the other spur gear. In a spur gear drive having two gears, center distance is equal to one-half the pitch diameter of the pinion (which, you will remember from Chapter 1 is the smaller of two spur gears) plus one-half the pitch diameter of the gear. Or, better still, simply add the sum of the two pitch diameters and divide by two. (See Figure 2.7)

Example: The center distance of a 4-inch pitch diameter gear running with a 2-inch pitch diameter pinion is 3 inches. $4" + 2" \div 2 = 3" \text{ CD}$

ROTATION – the direction in which a gear revolves while in operation – is one of the most important concepts in the power transmission.

- In a spur drive having two gears, the pinion and gear will rotate in opposite directions. (See Figure 2.8A)
- In a spur gear train having three gears, the pinion and gear will rotate in the same direction. (See Figure 2.8B)

GEAR RATIO the mathematical ratio of a pair of spur gears – is determined by dividing the number of teeth on the larger gear with the number of teeth on the pinion.

Example: The ratio of a 72-tooth gear running with a 16-tooth pinion is 4.5:1.

Ratio: $72 \div 16 = 4.5$

Gear ratio is important because it determines the drive speed.

VELOCITY, or speed, is the distance any point on the circumference of a pitch circle will travel in a given period of time. *In the world of gears, this period of time is always measured in feet per minute (fpm).*

Example: If you have a gear with a 2-foot pitch circumference and a given point on that circumference takes one minute to travel around the entire circumference, the gear is moving at a velocity of 2 feet per minute.

You can also figure out the velocity using the following formula:

Velocity = pitch diameter (PD) x .262 x revolutions (of the gear) per minute (rpm)

Example: What is the velocity of a Boston Gear NO18B spur gear – which, as you will see in the catalog has a 6-inch pitch diameter – turning at 7 rpm?

Velocity = 6" x .262. x 7 rpm, or 10.999 feet per minute (fpm)

REMEMBER THIS!
When there is an even number of gears, the pinion and driver will rotate in opposite directions.
When there is an odd number of gears, the pinion and driver will rotate in the same direction.

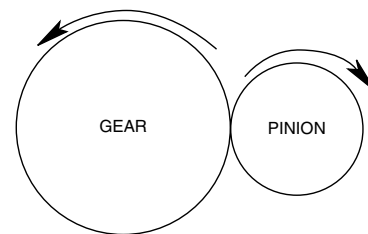

Figure 2.8A, Even Number Gears

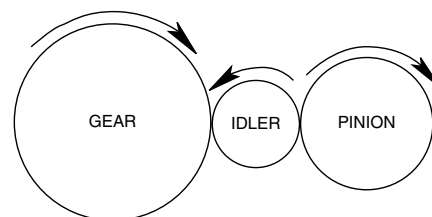
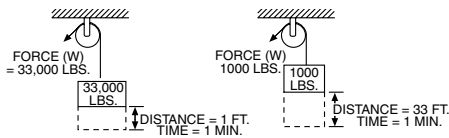

Figure 2.8B, Odd Number Gears

CATALOG CHECK! All the formulas you need to help your customers choose the right gear drives are contained in the Engineering section of your Boston Gear catalogs.

ILLUSTRATION OF HORSEPOWER



$$HP = \frac{33,000 \times 1}{33,000 \times 1} = 1 \text{ HP} \quad HP = \frac{1000 \times 33}{33,000 \times 1} = 1 \text{ HP}$$

TORQUE (T) is the product of a FORCE (W) in pounds, times a RADIUS (R) in inches from the center of shaft (Lever Arm) and is expressed in Inch Pounds.

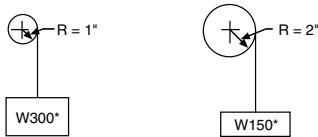

$$T = WR = 300 \times 1 = 300 \text{ In. Lbs.} \quad T = WR = 150 \times 2 = 300 \text{ In. Lbs.}$$

If the shaft is revolved, the FORCE (W) is moved through a distance, and WORK is done.

$$\text{WORK (Ft. Pounds)} = W \times \frac{2\pi R}{12} \times \text{No. of Rev. of Shaft.}$$

When this WORK is done in a specified TIME, POWER is used.

$$\text{POWER (Ft. Pounds per Min.)} = W \times \frac{2\pi R}{12} \times \text{RPM}$$

Since (1) HORSEPOWER = 33,000 Foot Pounds per Minute

$$\text{HORSEPOWER (HP)} = W \times \frac{2\pi R}{12} \times \frac{\text{RPM}}{33,000} = \frac{W \times R \times \text{RPM}}{63,025}$$

but TORQUE (Inch Pounds) = FORCE (W) X RADIUS (R)

$$\text{Therefore HORSEPOWER (HP)} = \frac{\text{TORQUE (T)} \times \text{RPM}}{63,025}$$

TABLE I

Service Factor	Operating Conditions
.8	Uniform — not more than 15 minutes in 2 hours.
1.0	Moderate Shock — not more than 15 minutes in 2 hours. Uniform — not more than 10 hours per day.
1.25	Moderate Shock — not more than 10 hours per day. Uniform — more than 10 hours per day.
1.50	Heavy Shock — not more than 15 minutes in 2 hours. Moderate Shock — more than 10 hours per day.
1.75	Heavy Shock — not more than 10 hours per day.
2.0	Heavy Shock — more than 10 hours per day.

Heavy shock loads and/or severe wear conditions may require the use of higher service factors. Consultation with factory is recommended in these applications.

Put yourself to the test: Using Boston Gear catalog no. YFBO, determine the velocity of the following spur gears travelling at 9 rpm: Velocity =

HOW TO FIGURE HORSEPOWER and TORQUE

The charts on this page illustrate formulas you can use to determine horsepower and torque. Once you work with them a while, they will be much easier to use.

SERVICE CLASS

Service Factors are numbers which modify the loads and must be considered when selecting a speed reducer. They vary with the type of service in which the reducer is to be used, the kind of prime mover involved and the duty cycle. The service factor can be a multiplier applied to the known load, which redefines the load in accordance with the conditions at which the drive will be used, or it can be a divisor applied to catalog reducer ratings, thus redefining the rating in accordance with drive conditions.

When selecting gears, the service class is dependent on operating conditions – also referred to as the *duty cycle*. You can determine your gear needs using the following procedure

1. Determine the service factor by using Table 1.
2. Multiply the horsepower required for the application by the service factor.
3. Select the spur gear pinion with a Boston Gear catalog rating equal to or greater than the horsepower determined in step 2.
4. Select spur gear with a Boston Gear catalog rating equal to or greater than the horsepower determined in step 2.

Example: An application having a service factor of 1.5 and a required horsepower of 6.0 would require a pinion with a rating equal to or greater than 9.0 (1.5 x 6.0) and a gear with a rating equal to or greater than 9.0 (1.5 x 6.0).

SELECTING THE RIGHT GEAR DRIVE FOR THE APPLICATION

As discussed in chapter 1, *horsepower, torque and duty cycle* (operating conditions) are three of the most important variables to consider when helping a customer select the correct gear drive(s). In addition, there are two other important variables – *center distance and ratio* – that you will need to know in order to meet speed (rpm) requirements and space limitations.

When you know the five variables listed above – *horsepower, torque, duty cycle, center distance and ratio* – you can select the right spur gears for any application using a three-step process. Let's walk through that process using the following variables:

- Center distance = 3"
- Ratio required = 3:1
- Horsepower required = 5.5
- Velocity of pinion = 1,800 rpm
- Velocity of gear = 600 rpm
- Service factor = 1.25

Step 1 – Find the pitch diameter (PD) of the pinion and gear (assuming the center distance and ratio are fixed) using the following formulas:

$$\begin{aligned} \text{PD of pinion} &= 2 \times \text{center distance} \div \text{ratio} + 1 \\ \text{PD of gear} &= \text{PD of pinion} \times \text{ratio} \end{aligned}$$

Now let's insert the figures from our sample set of variables and do the math:

$$\begin{aligned} \text{PD of pinion} &= (2 \times 3") \div (3 + 1) = 6 \div 4 \text{ or } 1.5 \\ \text{PD of pinion} &= 1.5" \end{aligned}$$

Now that we know the PD of the pinion (1.5) and the required ratio (3:1), we can figure the PD of the gear.

$$\text{PD of gear} = 1.5" \times 3 \text{ or } 4.5"$$

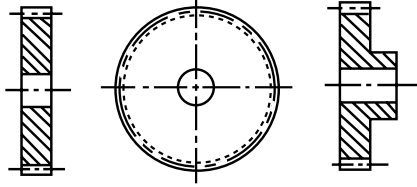

Figure 2.10, Plain – Style A

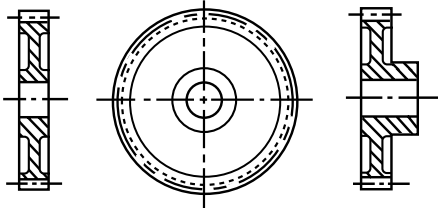

Figure 2.11A, Web – Style B

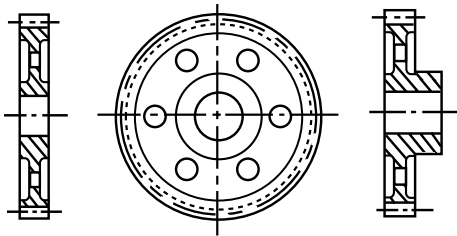

Figure 2.11B, Web with Lightning Holes-Style C

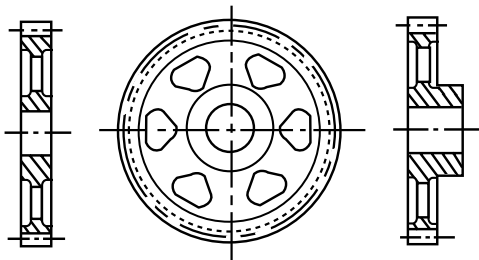

Figure 2.11C, Spoke – Style D

Step 2 – Multiply the required horsepower by the service factor to determine the horsepower rating for the pinion and gear (making sure to check the horsepower rating sheets in the appropriate Boston Gear catalog). Select the pinion and gear according to these known specifications.

Required horsepower = 5.5

Service factor = 1.25

$5.5 \times 1.25 = 6.88$, therefore:

Horsepower rating for pinion = 6.88 at 1800 rpm

Horsepower rating for gear = 6.88 at 600 rpm

Step 3 – Check the horsepower ratings of both the pinion and gear selected against the ratings in the appropriate Boston Gear catalogs.

Using the horsepower calculations for the pinion and gear (as determined in Step 2), select the Boston Gear stock pinion and gear that should be used for this application from the chart on page 32 of the Gears catalog.

Did you choose the Boston Gear Stock YF15 Pinion and YF45 Gear?

GEAR BLANKS

Boston Gear stock spur gears are manufactured (with and without hub) in four styles:

Plain – brief description of style (See Figure 2.10)

Webbed – brief description of style (See Figure 2.11A)

Webbed – with lightning holes (See Figure 2.11B)

Spoked – brief description of style (See Figure 2.11C)

With the exception of Stock Boston Gear change gears (which have two keyways 180-degrees apart), standard spur gears are normally stocked without set-screws or keyways.

ORDERING NON-STOCK GEARS

When ordering modified stock or special made-to-order gears, it is important to use the correct terminology so everyone is speaking the “same language”.

That’s just about everything you need to know about Boston Gear spur gears at this stage of your training. Now, it’s time to put your knowledge to the test. But before you do, let’s review some key points from chapter 2.

GEAR GLOSSARY

ADDENDUM (a) is the height by which a tooth projects beyond the pitch circle or pitch line.

BASE DIAMETER (D_b) is the diameter of the base cylinder from which the involute portion of a tooth profile is generated.

BACKLASH (B) is the amount by which the width of a tooth space exceeds the thickness of the engaging tooth on the pitch circles. As actually indicated by measuring devices, backlash may be determined variously in the transverse, normal, or axial-planes, and either in the direction of the pitch circles or on the line of action. Such measurements should be corrected to corresponding values on transverse pitch circles for general comparisons.

BORE LENGTH is the total length through a gear, sprocket, or coupling bore.

CIRCULAR PITCH (p) is the distance along the pitch circle or pitch line between corresponding profiles of adjacent teeth.

CIRCULAR THICKNESS (t) is the length of arc between the two sides of a gear tooth on the pitch circle, unless otherwise specified.

CLEARANCE-OPERATING (c) is the amount by which the dedendum in a given gear exceeds the addendum of its mating gear.

CONTACT RATIO (m_c) in general, the number of angular pitches through which a tooth surface rotates from the beginning to the end of contact.

DEDENDUM (b) is the depth of a tooth space below the pitch line. It is normally greater than the addendum of the mating gear to provide clearance.

DIAMETRAL PITCH (P) is the ratio of the number of teeth to the pitch diameter.

FACE WIDTH (F) is the length of the teeth in an axial plane.

FILLET RADIUS (r_f) is the radius of the fillet curve at the base of the gear tooth.

FULL DEPTH TEETH are those in which the working depth equals 2.000 divided by the normal diametral pitch.

GEAR is a machine part with gear teeth. When two gears run together, the one with the larger number of teeth is called the gear.

HUB DIAMETER is outside diameter of a gear, sprocket or coupling hub.

HUB PROJECTION is the distance the hub extends beyond the gear face.

INVOLUTE TEETH of spur gears, helical gears and worms are those in which the active portion of the profile in the transverse plane is the involute of a circle.

LONG- AND SHORT-ADDENDUM TEETH are those of engaging gears (on a standard designed center distance) one of which has a long addendum and the other has a short addendum.

KEYWAY is the machined groove running the length of the bore. A similar groove is machined in the shaft and a key fits into this opening.

NORMAL DIAMETRAL PITCH (P_n) is the value of the diametral pitch as calculated in the normal plane of a helical gear or worm.

NORMAL PLANE is the plane normal to the tooth surface at a pitch point and perpendicular to the pitch plane. For a helical gear this plane can be normal to one tooth at a point laying in the plane surface. At such point, the normal plane contains the line normal to the tooth surface and this is normal to the pitch circle.

NORMAL PRESSURE ANGLE (ϕ_n) in a normal plane of helical tooth.

OUTSIDE DIAMETER (D_o) is the diameter of the addendum (outside) circle.

GEAR GLOSSARY (Continued)

PITCH CIRCLE is the circle derived from a number of teeth and a specified diametral or circular pitch. Circle on which spacing or tooth profiles is established and from which the tooth proportions are constructed.

PITCH CYLINDER is the cylinder of diameter equal to the pitch circle.

PINION is a machine part with gear teeth. When two gears run together, the one with the smaller number of teeth is called the pinion.

PITCH DIAMETER (D) is the diameter of the pitch circle. In parallel shaft gears, the pitch diameters can be determined directly from the center distance and the number of teeth.

PRESSURE ANGLE (ϕ) is the angle at a pitch point between the line of pressure which is normal to the tooth surface, and the plane tangent to the pitch surface. In involute teeth, pressure angle is often described also as the angle between the line of action and the line tangent to the pitch circle. Standard pressure angles are established in connection with standard gear-tooth proportions.

ROOT DIAMETER (D_r) is the diameter at the base of the tooth space.

PRESSURE ANGLE—OPERATING (ϕ_o) is determined by the center distance at which the gears operate. It is the pressure angle at the operating pitch diameter.

TIP RELIEF is an arbitrary modification of a tooth profile whereby a small amount of material is removed near the tip of the gear tooth.

UNDERCUT is a condition in generated gear teeth when any part of the fillet curve lies inside a line drawn tangent to the working profile at its point of juncture with the fillet.

WHOLE DEPTH (h_w) is the total depth of a tooth space, equal to addendum plus dedendum, equal to the working depth plus variance.

WORKING DEPTH (h_w) is the depth of engagement of two gears; that is, the sum of their addendums.

TOOTH PARTS

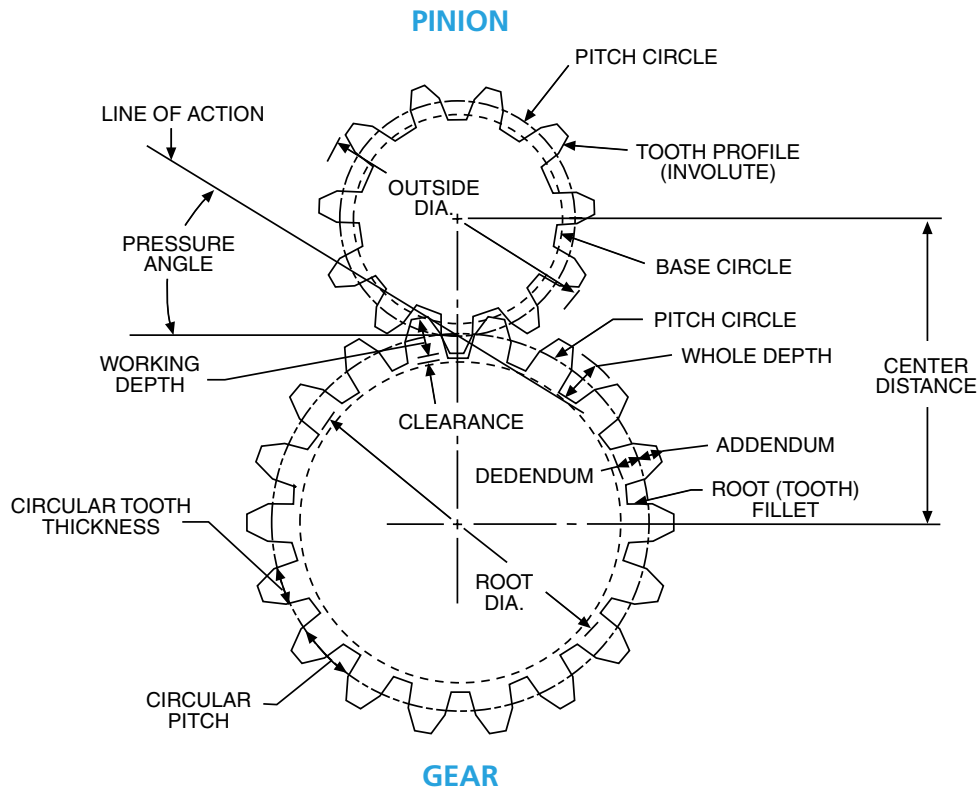

Keypoints

- Boston Gear makes a wide variety of spur gears, ranging from 64 diametral pitch (DP) to 3 DP in 20-degree pressure angle (PA), and 48 DP to 3DP in 14 1/2° PA.
- Boston Gear pinions and gears are available in steel, cast iron, brass, and non-metallic materials
- Boston Gear manufactures five types of spur gears:
 - Change gears (steel or cast iron)
 - Stem pinions (steel)
 - Drawn pinion wire (brass, steel)
 - Rack (brass, steel, nylon)
 - Internal (brass)

Quiz

CLICK HERE or visit <http://www.bostgear.com/quiz> to take the quiz

QUIZ

HELICAL GEARS

3



COMMON APPLICATIONS:
Helical gears are commonly used when efficiency and quieter operation are important.

CATALOG CHECK:
Boston Gear makes a complete line of standard stock helical gears in both bronze and steel. All Boston Gear distributors should have them in stock. The complete line of Boston Gear helical gears is featured in the Gears catalog.

Now that you've been introduced to the most common gear – the spur gear – let us turn our attention to another commonly used gear, the **helical gear**.

Helical gears are similar to spur gears except that their teeth are cut at an angle to the hole (axis) rather than straight and parallel to the hole like the teeth of a spur gear.

(See Figure 3.0)

Helical gears are used to connect non-intersecting shafts. Boston standard helical gears with 45-degree *helix angles* (a term that will be discussed below) are used to connect parallel shafts or shafts at right (90°) angles.

Helical gears are manufactured as both *right and left-hand gears*. The teeth of a left-hand helical gear lean to the left when the gear is placed on a flat surface. The teeth of a right-hand helical gear lean to the right when placed on a flat surface. (See Photo 3.1)

Opposite hand helical gears run on parallel shafts. Gears of the same hand operate with shafts of 90°.

(See Photo 3.1A)

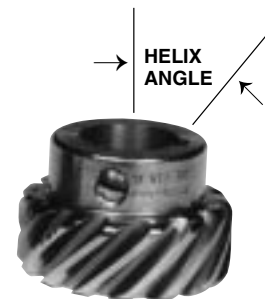

Figure 3.0

Right Hand Helical Gear



Left Hand Helical Gear



Photo 3.1, The teeth of a RIGHT HAND Helical Gear lean to the right when the gear is placed flat on a horizontal surface. The teeth of a LEFT HAND Helical Gear lean to the left when the gear is placed flat on a horizontal surface.

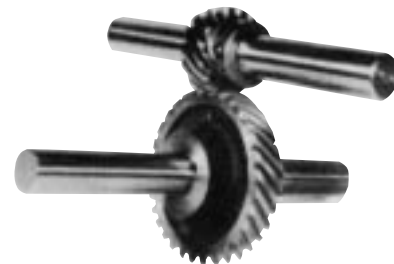

Photo 3.1A, Helical Gears on Non-Parallel Shafts Shaft Angle 90° Both Gears Right Hand

Now let's look at two configurations of helical gear connections: those connecting parallel shafts and those connecting non-parallel shafts.

Helical Gears Connecting Parallel Shafts

Helical gears connecting parallel shafts will run more smoothly and quietly than spur gears, particularly when the helix angle is great enough to ensure that there is continuous contact from one tooth to the next. A pair of helical gears used to connect parallel shafts must have the same pitch, pressure angle and helix angle, but they will be opposite hand gears (that is, one will be a left-hand gear; the other a right-hand gear).

Helical Gears Connecting Non-Parallel Shafts

Helical gears used to connect non-parallel shafts are commonly called *spiral gears* or *crossed axis helical gears*. If the *shaft angle* is 90 degrees, the gears will be of the same hand and the sum of the helix angles will be equal to the shaft angle (90 degrees).

Helical gears used on non-parallel shafts must have the same normal pitch and normal pressure angles (terms that were introduced in chapter 2, remember?). They may, however, be of the same or opposite hand depending on the shaft angle.

Time Out: With us so far? If not, don't worry. We're about to familiarize you with some basic concepts and terms that will help you understand everything you need to know at this stage of our lesson on helical gears.

Now let's continue our discussion about helical gears with a look at how to determine a gear's basic dimensions.

REMINDER: Whenever you forget the meaning of a term used in our Gearology course, remember that definitions are provided in preceding chapters and/or in the glossary at the end of the chapters.

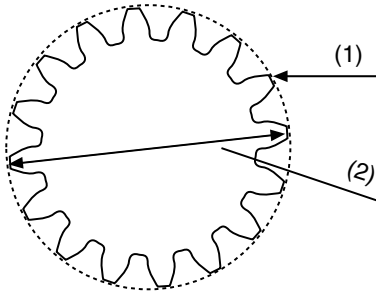

Figure 3.1, Outside Diameter

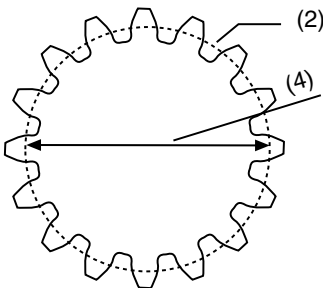

Figure 3.1A

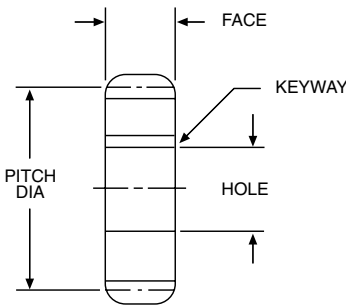

Figure 3.2, (A) Plain Style - No Hub

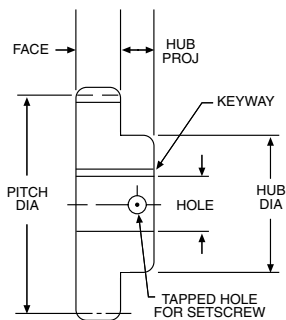

Figure 3.2, (B) Plain Style - With Hub

BASIC CIRCLE DIMENSIONS

A helical gear has two major circles:

- 1) the *outside circle* and 2) the *pitch circle*.

The outside circle is the distance around the outer edge of the gear's teeth. (1 and 2) The diameter of the outside circle is called the outside diameter.

(See Figure 3.1)

The pitch circle is the imaginary circle found at the point where the teeth of two gears mesh (come in contact, See 2 and 4). The diameter of the pitch circle is called the pitch diameter. (See Figure 3.1A)

Sound familiar? It should. You learned about pitch circles and pitch diameters in the chapter on spur gears, remember?

BASIC PHYSICAL DIMENSIONS

Data regarding the basic dimensions of Boston gears (as shown below) are always specified in your Boston Gear catalogs, whether you are looking for information on plain style/no hub gears (See Figure 3.2A) or plain style/with hub gears. (See Figure 3.2B)

CENTER DISTANCE

As you will remember from Chapter 2, the *center distance* of two mating gears (helical gears and spur gears alike) is the distance between the centers of the gears, or half the sum of the two *pitch diameters*.

Example: If the center distance is designated as C, and the two pitch diameters are designated as D and d, then: $C = D + d \div 2$. Therefore, if you have two mating helical gears, one (D) with a 4" pitch diameter and one (d) with a 2" pitch diameter, then the center distance (C) will be 3" ($4 + 2 \div 2 = 3$).

PITCH DIAMETER

The *pitch diameter* of a *helical pinion* (which, you will remember from our introduction to Gearology, is the smaller of two mating gears) and mating gear for a given *ratio* and *center distance* may be determined using the following formulas:

$$\text{Pinion pitch diameter (d)} = 2C \div \text{ratio} + 1$$

$$\text{Gear pitch diameter (D)} = d \times \text{ratio}$$

Note: These formulas are not applicable to crossed axis helical gears with unequal helix angles.

Before we go any further with our lesson on helical gears, let's get more familiar with some of the terms commonly used when determining the correct helical gears to use for selected applications. Some you have been introduced to previously; others may be new to you.

HELIX ANGLE

The *helix angle* is the angle between the axis (bore) of a helical gear and an (imaginary) line tangent to the tooth. The helix angle will be between 0° and 90°. (See Figure 3.3)

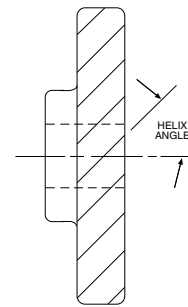

Figure 3.3

SHAFT ANGLE

The shaft angle of a pair of crossed helical gears is the angle that lies between the ends of the shafts that rotate in opposite directions. (See Figure 3.3A)

Note: There are two different angles between intersecting shafts (one being 180° minus the other). However, only the angle that meets the above definition is designated as the *shaft angle*.

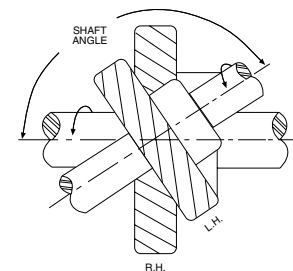

Figure 3.3A

Note that in the two diagrams to the right that although the shaft axes lie in the same direction, the shaft angles are not the same because the shaft rotations are different. (See Figure 3.3A, 3.3B)

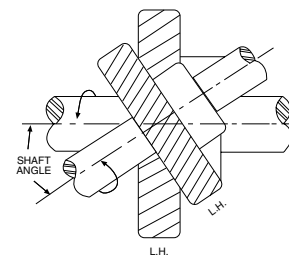

Figure 3.3B

IMPORTANT: Either the correct shaft angle – or one of the angles between the shafts and the direction of rotation of each shaft – must be provided before helical gears can be designed to fulfill specific application requirements

IMPORTANT:

All Boston Gear standard stock helical gears have a 14 1/2-degree normal pressure angle.

CATALOG CHECK!

Two different pitches are listed in your Boston Gear catalog: the diametral pitch (which is the same as the transverse diametral pitch) and the normal pitch (the diametral pitch of the gear and the hob or cutter used to cut the teeth).

TRANSVERSE PITCH

The *transverse pitch* of a helical gear corresponds to the pitch of a spur gear with the same number of teeth and the same pitch diameter. It is measured in the plane rotation of the gear. (See Figure 3.3C)

Transverse diametral pitch (D.P.) = 3.1416 (Transverse circular pitch (C.P.))

NORMAL PITCH

The *normal pitch* of a helical gear is the pitch of the tool used to cut the teeth. It is measured in a plane perpendicular to the direction of the teeth.

Normal diametral pitch (D.P.) = 3.146 (Normal circular pitch (C.P.))

NORMAL PRESSURE ANGLE

Normal pressure angle is the pressure angle in the normal plane of a helical gear tooth.

Now that you are more familiar with many of the terms used in our Gearology course, you should be able to begin using the helical gear formulas (page 3-7) in concert with the information contained in your Boston Gear catalog.

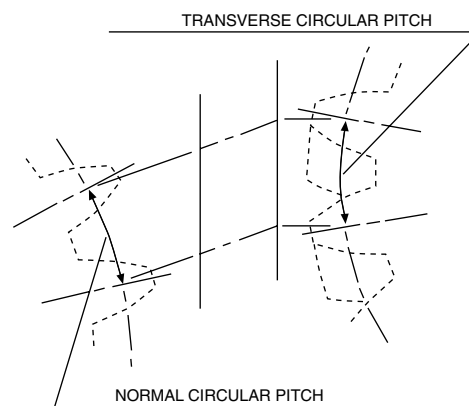

Figure 3.3C

HELICAL GEAR FORMULAS. . .

	TO FIND	HAVING	RULE
1	Transverse Diametral Pitch	Number of Teeth and Pitch Diameter	Divide the Number of Teeth by the Pitch Diameter
2	Transverse Diametral Pitch	Normal D.P. and Helix Angle	Multiply the Normal D.P. by the cosine of the Helix Angle
3	Pitch Diameter	Number of Teeth and Transverse D.P.	Divide the Number of Teeth by the Transverse D.P.
4	Normal Diametral Pitch	Transverse D.P. and Helix Angle	Divide the Transverse D.P. by the cosine of the Helix Angle
5	Helix Angle	Transverse D.P. and Normal D.P.	Divide the Transverse D.P. by the Normal D.P. — Quotient is the cosine of the Helix Angle
6	Transverse Pressure Angle	Normal P.A. and Helix Angle	Divide the tangent of the Normal P.A. by the cosine of the Helix Angle. Quotient is tangent of Transverse P.A.
7	Normal Circular Tooth Thickness	Normal Diametral Pitch	Divide 1.5708 by the Normal Diametral Pitch
8	Addendum	Normal Diametral Pitch	Divide 1 by the Normal Diametral Pitch
9	Outside Diameter	Addendum and Pitch Diameter	Add 2 Addendums to the Pitch Diameter
10A	Whole Depth (Coarser than 20 D.P.)	Normal Diametral Pitch	Divide 2.250 by the Normal Diametral Pitch
10B	Whole Depth (20 D.P. and Finer)	Normal Diametral Pitch	Divide 2.200 by the Normal D.P. and add .002
11	Clearance	Addendum and Whole Depth	Subtract 2 Addendums from the Whole Depth

Now let's look at three more important factors to keep in mind when selecting the "right" helical gears for your customers' applications: *ratio*, *rotation* and *thrust*.

RATIO

The ratio of a pair of helical gears may be determined from the shaft speed or the number of teeth in the two gears.

Ratio = RPM of Driving Gear \div RPM of Driven Gear

Example: Ratio = $900 \div 900 = 1$

Ratio = No. of Teeth in Driven Gear \div No. of Teeth in Driving Gear

Example: Ratio = $12 \div 12 = 1$

ROTATION

In a helical gear train with an even number (2, 4, 6, 8, etc.) of gears in mesh, the first gear (the driver) and the last gear (the driven) will always rotate in opposite directions. All even numbers of gears will rotate in opposite directions in relation to the pinion or driver.

In a helical gear train with an odd number (1, 3, 5, 7, etc.) of gears in mesh, the first gear (the driver) and the last gear (the driven gear) will always rotate in the same direction. All odd numbers of gears will rotate in the same direction in relation to the pinion or driver.

THRUST

The chart on page 3-9 illustrates the thrust (the driving force or pressure) of helical gears when they are rotated in various directions, as well as where the bearings should be placed to absorb the thrust in each example. Use it to help determine the correct hand helical gears (right or left) for various customer applications, as well as the thrust of helical gears at right angles (90 degrees) or parallel to one another.

THRUST CHART

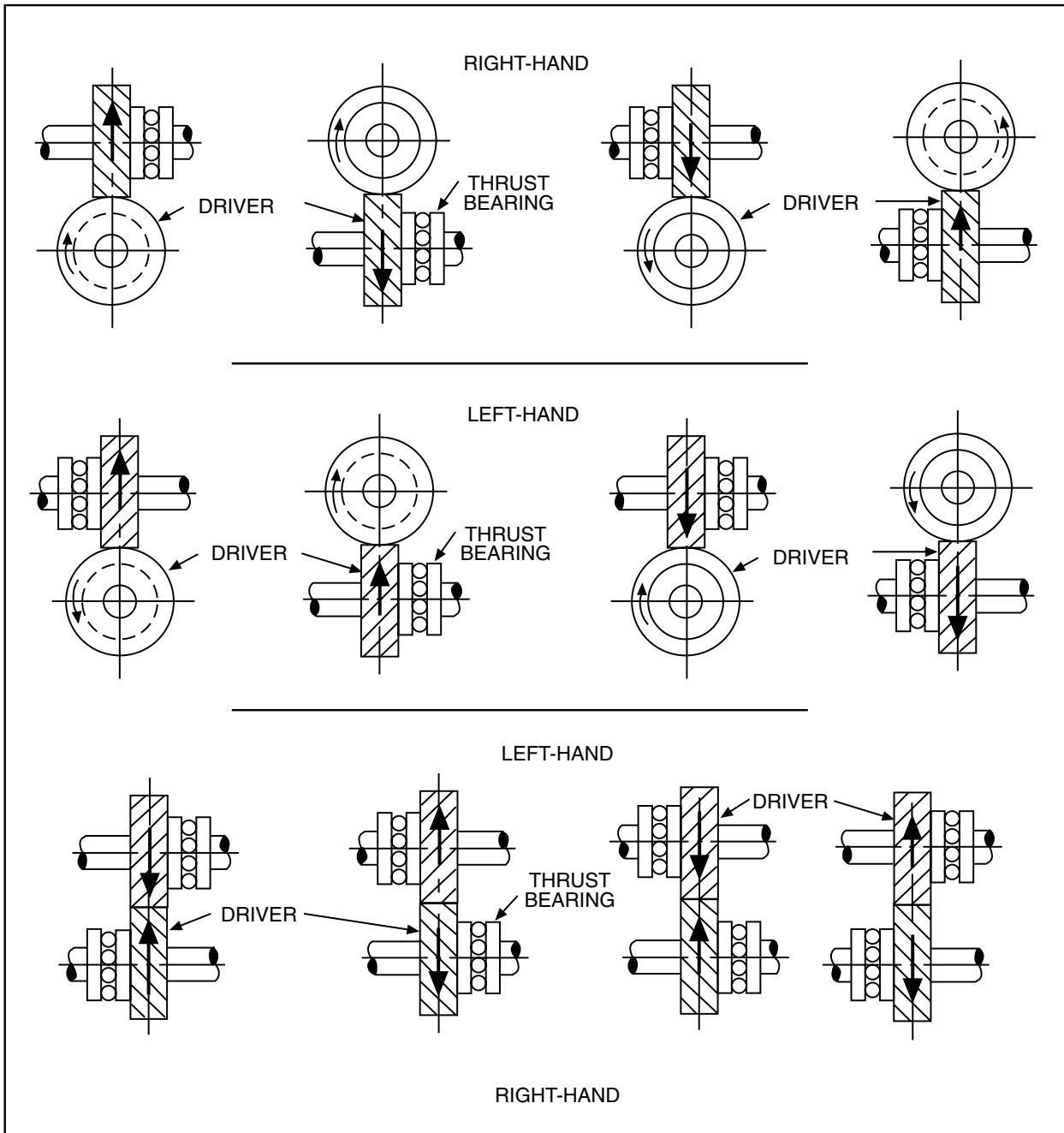

CATALOG CHECK!

All the formulas you need to help your customers choose the right helical gears are contained in the Engineering section of your Boston Gear catalogs.

HORSEPOWER RATINGS

Approximate horsepower ratings for selected sizes (number of teeth) of helical gears operating at various speeds (RPM) are provided for hardened steel gears on the horsepower and torque charts on pages 55-56 of the Gears catalog. (A sample chart is shown in Figure 3.4)

The horsepower ratings are based on the beam strength of the gear teeth. These ratings are for parallel shaft applications under normal operating conditions (defined as smooth load, "shockless" operations for 8-10 hours per day where gears are properly mounted and lubricated). Ratings for gear sizes and speeds not listed in your catalog may be estimated from the values indicated.

Note: Ratings for bronze gears are approximately 33% of the values indicated for hardened steel.

BOSTON HELICAL GEARS

HARDENED STEEL

14 1/2° NORMAL PRESSURE ANGLE 45° HELIX ANGLE

APPROXIMATE HORSEPOWER RATINGS ON PARALLEL SHAFTS

Catalog Number	No. Teeth	Pitch Diam.	Revolutions per Minute								
			50	100	200	300	450	600	900	1200	1800
24 DIAM. PITCH 1/4" Face (Except *3/8" Face) 33.94 NORMAL PITCH											
H2412*	12	500"	.02	.04	.07	.10	.15	.19	.27	.34	.46
H2418	18	.750	.02	.04	.07	.10	.15	.19	.26	.32	.43
H2424	24	1.000	.03	.05	.10	.14	.20	.25	.34	.41	.53
H2436	36	1.500	.04	.08	.14	.20	.28	.35	.46	.54	.67
H2448	48	2.000	.05	.10	.18	.26	.35	.43	.55	.63	.76
H2472	72	3.000	.08	.15	.26	.36	.47	.56	.68	.77	-
20 DIAM. PITCH 3/8" Face (Except 19/16" Face) 28.28 NORMAL PITCH											
H2010†	10	500	.03	.06	.12	.17	.25	.33	.47	.59	.80
H2015†	15	.750	.05	.09	.17	.25	.35	.44	.60	.73	.93
H2020	20	1.000	.05	.10	.19	.27	.39	.50	.70	.86	1.14
H2030	30	1.500	.07	.14	.25	.36	.50	.62	.81	.97	1.19
H2040	40	2.000	.09	.18	.33	.46	.63	.77	.98	1.14	1.36
H2060	60	3.000	.14	.26	.47	.64	.84	.99	1.22	1.38	-
16 DIAMETRAL PITCH 1/2" Face 22.63 NORMAL PITCH											
H1608	8	.500	.03	.06	.12	.18	.27	.34	.49	.62	.84
H1612	12	.750	.05	.11	.21	.29	.42	.54	.75	.93	1.22
H1616	16	1.000	.07	.14	.28	.40	.56	.71	.97	1.18	1.51
H1632	32	2.000	.15	.29	.54	.76	1.03	1.26	1.61	1.87	2.24
H1648	48	3.000	.24	.43	.77	1.05	1.38	1.64	2.01	2.28	-
12 DIAMETRAL PITCH 3/4" Face 16.97 NORMAL PITCH											
H1212	12	1.000	.14	.27	.53	.76	1.08	1.36	1.85	2.26	2.89
H1218	18	1.500	.22	.44	.80	1.14	1.58	1.96	2.57	3.05	3.76
H1224	24	2.000	.30	.58	1.07	1.49	2.03	2.47	3.17	3.68	4.40
H1236	36	3.000	.47	.85	1.53	2.08	2.74	3.25	4.00	4.51	-
10 DIAMETRAL PITCH 7/8" Face 14.14 NORMAL PITCH											
H1010	10	1.000	.19	.37	.71	1.02	1.45	1.83	2.49	3.04	3.89
H1015	15	1.500	.30	.60	1.10	1.56	2.17	2.69	3.54	4.20	5.16
H1020	20	2.000	.41	.79	1.47	2.05	2.79	3.40	4.35	5.06	6.05
H1030	30	3.000	.65	1.19	2.13	2.89	3.80	4.51	5.54	6.26	-
H1040	40	4.000	.84	1.55	2.70	3.58	4.59	5.33	6.37	-	-
8 DIAMETRAL PITCH 3/4" Face 11.31 NORMAL PITCH											
HS812	12	1.500	.31	.62	1.14	1.61	2.24	2.78	3.65	4.33	5.33
HS816	16	2.000	.43	.83	1.53	2.14	2.91	3.55	4.54	5.28	6.30
HS824	24	3.000	.68	1.25	2.24	3.04	4.00	4.75	5.84	6.59	-
HS832	32	4.000	.88	1.63	2.84	3.77	4.83	5.62	6.71	-	-
HS848	48	6.000	1.29	2.32	3.84	4.91	6.04	6.82	-	-	-
6 DIAMETRAL PITCH 1" Face 8.48 NORMAL PITCH											
HS612	12	2.000	.73	1.41	2.60	3.63	4.94	6.01	7.70	8.95	10.7
HS618	18	3.000	1.17	2.14	3.84	5.22	6.86	8.14	10.0	11.3	-
HS624	24	4.000	1.54	2.85	4.97	6.60	8.45	9.82	11.7	-	-
HS636	36	6.000	2.28	4.09	6.77	8.67	10.7	12.0	-	-	-

*† Horsepower ratings are proportional to Face Width. Horsepower ratings of bronze gears are approximately 33% of above ratings.

SELECTING THE RIGHT HELICAL GEARS

Helical Gears Operating on Parallel Shafts

The following exercise will help you learn how to select the right helical gears for your Boston Gear customers when the gears are operated on parallel shafts. Let's walk through the selection process using the following variables:

- Shafts = Parallel
- Ratio = 3:1
- Speed = 1,800 RPM, pinion
- Horsepower required = 5
- Center distance = 4"
- Hand, pinion = Right hand
- Hand, gear = Left hand

Step 1

Find the pitch diameter (PD) of the pinion using the following formula:

- PD Pinion = 2 x CD (center distance) ÷ Ratio + 1
- PD Pinion = 2 x 4 ÷ 3 + 1
- PD Pinion = 2 inches

Figure 3.4

Find the pitch diameter (PD) of the gear using the following formula:

- $PD_{\text{Gear}} = PD_{\text{Pinion}} \times \text{Ratio}$
- $PD_{\text{Gear}} = 2 \times 3$
- $PD_{\text{Gear}} = 6 \text{ inches}$

Step 2

Referring to the horsepower ratings (RPM) in your Boston Gear catalog, look down the column labeled "1800" until you find a 2-inch pitch diameter gear with a rating of 5 – or more – horsepower.

If you have followed along correctly, it appears as though a 10-pitch, 20-tooth gear (H1020) will be capable of carrying this horsepower. Upon further checking, however, you will find that there is no stock helical gear with 60 teeth available to complete the drive.

Accordingly, the next gear with a 2-inch pitch diameter capable of carrying your load is the 8-pitch, 16-tooth gear (HS816R). Given that there is a 48-tooth gear available from stock (HS848L), these gears are the ones to use to meet the specifications set forth in our example.

HELICAL GEARS OPERATING ON NON-PARALLEL SHAFTS

When helical gears are operated on non-parallel shafts, the tooth load is concentrated at a specific point. *The result: very small loads will produce high pressures.* In addition, the *sliding velocity* is usually quite high; this, combined with the aforementioned concentrated pressure may produce excessive wear, especially if the teeth are not well-lubricated (see page 3-12 "Lubrication").

For these reasons, the tooth load, which may be applied to such drives (where helical gears are operating on non-parallel shafts) is very limited and of uncertain value. As a result, it is best to determine the "correct" tooth load through "trial and error" under *actual* operating conditions. If one of the gears is bronze, the contact area (and corresponding load-carrying capacity) may be increased by allowing the gears to "run-in" in their operating position, under loads which gradually increase to the maximum expected load.

LUBRICATION

Helical gears should be properly lubricated to: minimize wear; prevent the generation of excessive heat; improve efficiency through the reduction of friction between the mating tooth surfaces; reduce noise; and inhibit the formation of rust.

Good lubrication depends on the formation of a film thick enough to prevent contact between the mating surfaces. The relative motion between gear teeth helps to produce the necessary film from the small wedge formed adjacent to the area of contact.

It is important that an *adequate supply of the correct lubricant is properly applied*. Keep the following lubrication guidelines in mind:

- A straight mineral oil lubricant should be used for most parallel shaft applications. Under heavy load conditions, mild extreme-pressure (E.P.) lubricants are suggested.
- Helical gears operating at right angles must always be well-lubricated. Extreme pressure (E.P.) lubricants are recommended.
- Extreme pressure (E.P.) lubricants are not recommended on bronze gears.

That's just about everything you need to know about helical gears at this stage of your training. Now, let's put your knowledge to the test. But before you do, let's review some key points from chapter 3.

Keypoints

- Helical gears are similar to spur gears except their teeth are cut at an angle (45°) to the axis hole
- Helical gears are used to connect parallel shafts or shafts at right angles (90°)
- Helical gears connecting parallel shafts will run more smoothly and quietly than spur gears
- Helical gears used to connect parallel shafts must have the same pitch, pressure angle, and helix angle and be of opposite hand (one Right Hand and one Left Hand)
- Helical gears come only in two styles: (A) Plain Style - No hole (B) Plain Style with hub

Quiz

CLICK HERE or visit <http://www.bostgear.com/quiz> to take the quiz

WORMS AND WORM GEARS

4



COMMON**APPLICATIONS:**

Worm and worm gear sets are used in many, everyday products including: electrical mixers, hubometers, right angle speed reducers and medical equipment

CATALOG CHECK:

Boston Gear carries a full line of standard stock worms and worm gears for use in open and enclosed drives. Check them out starting on page 73 of the Gears catalog

Now that you have an understanding of two of the more common types of gears – spur gears and helical gears – let's learn about two additional and highly versatile types of gears that are used to transmit motion and power at various speeds and speed ratios: **worms and worm gears**.

A **worm** is a gear with one or more cylindrical, screw-like threads (also referred to as "starts") and a face width that is usually greater than its diameter. A worm has a center hole (bore) for mounting the worm on a shaft.

Worm gears, like worms, also are cylindrical and bored for mounting on a shaft. However, unlike a worm, a worm gear's diameter is usually much larger than the width of its face.

Note: Worm gears differ from spur gears in that their teeth are somewhat different in shape and are always formed on an angle to the hole (axis) in order to mate with worms. (See Figure 4.1).

In order to transmit motion and power at various speeds and speed ratios, worms and worm gears *work in sets*, rotating on shafts at right angles to one another. The worm usually drives the worm gear. Accordingly, the worm gear is usually the driven member. (See Figure 4.1A)

Important: In worms and worm gear sets, both the worm and worm gear are of the same hand. Right-hand sets are considered standard. As a result, right-hand sets will always be furnished unless otherwise specified.



Figure 4.1, Worm



Figure 4.1A, Worm Gear

WHEN TO USE WORMS AND WORM GEARS

Worms and worm gears provide solutions to a wide range of drive problems, particularly when the following factors need to be considered:

- High ratio speed reduction
- Space limitations
- Right angle shafts
- Non-intersecting shafts

Now that you have been introduced to worms and worm gears, let's take a closer look at each, starting with the worm.

WORMS - IDENTIFYING THE NUMBER OF THREADS

Boston worms are cut with single, double, triple or quadruple threads. To determine the number of threads on a worm, look at an end view so you can see the "start" of each thread. One start means that you have a single thread, two starts a double thread, three starts a triple thread, and four starts, a quadruple thread. (See Figure 4.1B)

DIAMETRAL AND CIRCULAR PITCH

As you learned from our lessons on spur gears and helical gears, diametral pitch and circular pitch are two systems used to designate the size of a gear's teeth. Boston Gear stock worms and (worm gears) are listed in the Gears catalog according to their diametral pitch.

Diametral pitch (also referred to as pitch) is the relationship between the number of teeth in a gear and each inch of the gear's pitch diameter (PD). For example, a worm gear with 16 teeth (T) and a one-inch pitch diameter is a 16-diametral pitch (DP) gear.

$$DP = T \div PD \text{ or } DP = 16 \text{ teeth} \div 1 \text{ PD} = 16 \text{ DP}$$

Note: Diametral pitch can be measured using a gear gauge.

Important: Diametral pitch can also be determined using the following formula: $DP = 3.1416 \div \text{Circular (linear) pitch}$

Single Thread



One Start

Double Thread



Two Starts

Triple Thread



Three Starts

Quad Thread



Four Starts

Figure 4.1B

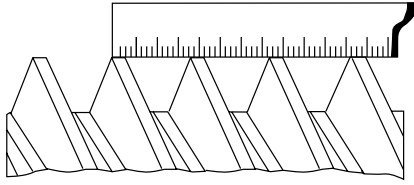

Figure 4.1, Worm

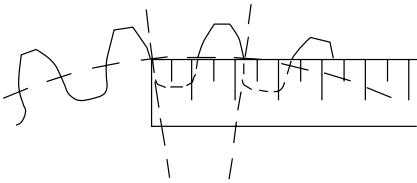

Figure 4.2, Worm Gear

CIRCULAR (LINEAR) PITCH

With a *worm*, circular (also referred to as linear) pitch is a distance measured along the *pitch line* of the gear. It can be determined by measuring – with an ordinary scale – the distance between any two corresponding points of adjacent threads parallel to the axis. (See Figure 4.1)

With a *worm gear*, circular pitch is a distance measured along the *pitch circle* of the gear. It can be determined by measuring – with an ordinary scale – the distance between any two corresponding points of adjacent teeth. As noted above, this measurement should be taken on the pitch circle, which is approximately halfway down a tooth. (See Figure 4.2)

WORMS–THREAD DIMENSIONS

The dimensions of a worm thread are important because they provide valuable information when determining a customer's needs.

As noted earlier, a worm thread is the part of the worm that wraps (spirals) around the cylindrical base of the worm, similar to the way the threads of a screw are configured.

The following terms are used when describing the dimensions of a worm-thread.

- Addendum – the part of the thread from the pitch line of the worm to the outer edge of the thread. (See Figure 4.3A)
- Dedendum – the part of the thread from the pitch line of the worm to the bottom of the thread. The dedendum is equal to one addendum plus the working clearance (defined below). (See Figure 4.3A)
- Working Clearance – the distance from the working depth (defined below) to the bottom of the thread. (See Figure 4.3A)
- Working Depth – the space occupied by the mating worm gear tooth. It is equal to twice the addendum. (See Figure 4.3A)
- Whole Depth – the distance from the bottom of the thread to its outside diameter.

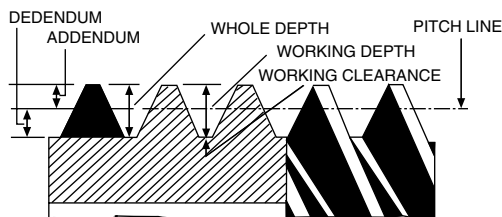

Figure 4.3A, Drawing of Worm showing cross section and full view of the thread

WORMS—PITCH DIAMETER

The pitch diameter of a worm is the diameter of the pitch circle (the “imaginary” circle on which the worm and worm gear mesh). There is no fixed method for determining the pitch diameter of a worm. (See *Figure 4.3B*)

Important: Pitch diameters can vary, but sound engineering practice dictates that they be as small as possible for the most efficient performance. Why? A small pitch diameter reduces the sliding velocity and, therefore, the efficiency of the worm.

WORMS—BASIC FORMULAS

The following formulas will be useful as you determine your customers’ needs with regard to the selection of the correct worms.

- Diametral pitch = $3.1416 \div$ circular (linear) pitch
- Circular (linear) pitch = $3.1416 \div$ diametral pitch
- Pitch diameter = outside diameter – 2 (addendum)
- Bottom diameter = outside diameter – 2 (whole depth)
- Outside diameter = pitch diameter + 2 (addendum)

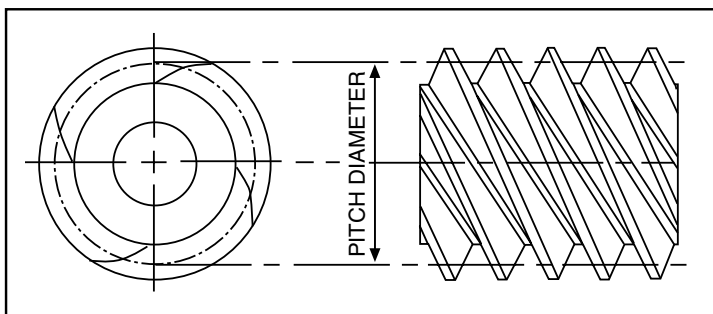

Figure 4.3B,
Pitch Diameter Worm

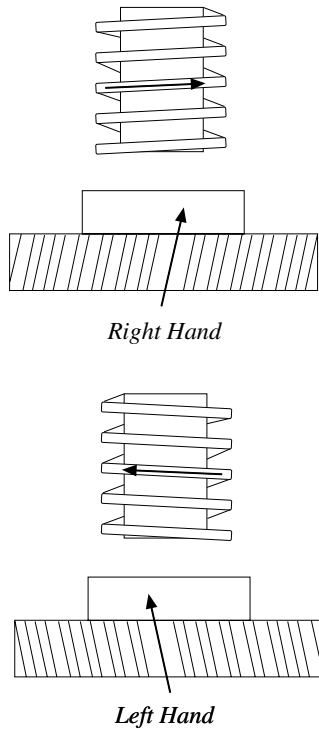

Figure 4.4

WORMS—HAND

Boston worms and worm gears are manufactured with right- or left-hand threads and teeth. The hand of a worm or worm gear may be determined by noting the direction in which the threads or teeth lean when the worm or worm gear is held with the hole facing up. (See Figure 4.4)

In a worm gear set, the worm and gear must have the same hand, pitch, number of threads, and tooth dimensions. They also must have the same pressure angle and lead angle (terms you will learn about below).

Reminder: Right hand worm and worm gear sets are considered standard. As a result, right-hand sets will always be furnished unless otherwise specified.

WORMS—LEADS AND LEAD ANGLE

The lead of a worm is the distance any one thread advances in a single revolution. The lead may be calculated using either one of the following formulas:

- Lead = (Number of worm threads x 3.1416) ÷ diametral pitch
- Lead = Circular pitch x number of worm threads

The following information also will come in handy when determining the lead of a worm:

- The lead and circular (linear) pitch are equal on single-thread worms.
- The lead is twice the circular pitch on double-thread worms.
- The lead is three times the circular pitch on triple-thread worms.
- The lead is four times the circular pitch on quadruple-thread worms.

WORMS—LEAD ANGLES

The *lead angle* of a worm is the angle formed by the worm thread and a line perpendicular to the worm axis.

(See Figure 4.5)

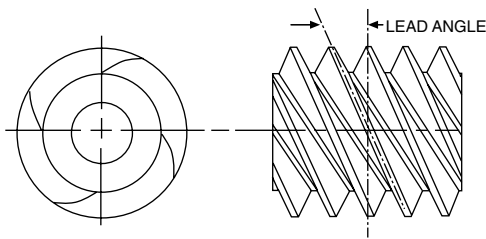

Figure 4.5, Worm

LEAD ANGLE VS. EFFICIENCY

The lead angle is an important factor in determining the efficiency of a worm and worm gear set. *The efficiency increases as the lead angle increases.*

For a given pitch, the lead angle is controlled principally by two factors: (1) the number of threads and (2) the pitch diameter of the worm. The lead angle can be determined from the lead and pitch diameter by using a formula in concert with a table of cotangents (as follows).

(Pitch diameter of worm x 3.1416) ÷ lead = Cotangent of lead angle
(See Figure 4.4)

Important: The mating worm and worm gear must have the same:

- Pitch
- Number of threads
- Tooth dimensions
- Hand
- Pressure angle
- Lead angle

(See Figure 4.4)

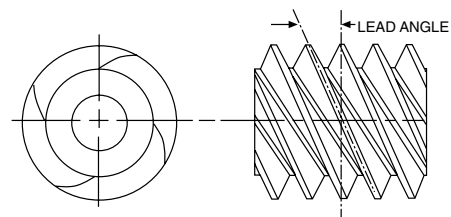

Figure 4.4, Worm

WORMS—PRESSURE ANGLE

The *pressure angle* is the angle at which a force is transmitted from the worm thread to the worm gear tooth. It determines the relative thickness of the base and top of the thread.

(See Figure 4.6)

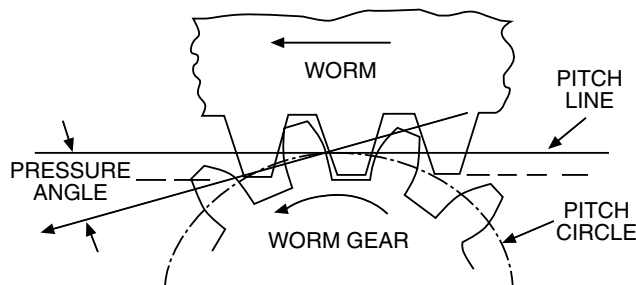
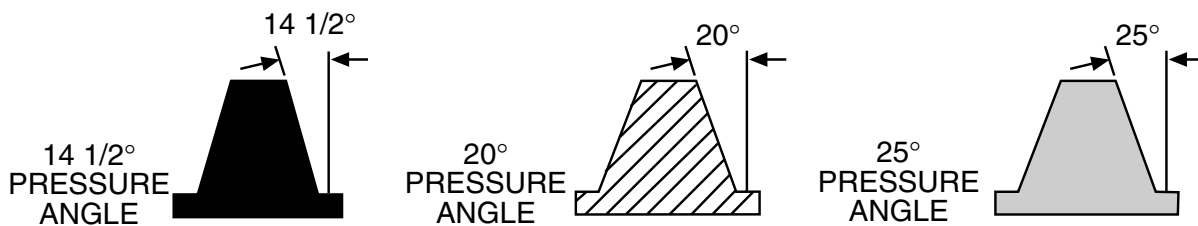

Figure 4.6

WORMS—PHYSICAL DIMENSIONS

When ordering special (made-to-order) worms, the pitch, pitch diameter, pressure angle, number of threads and hand should always be specified, as should the physical dimensions illustrated in 4.7.

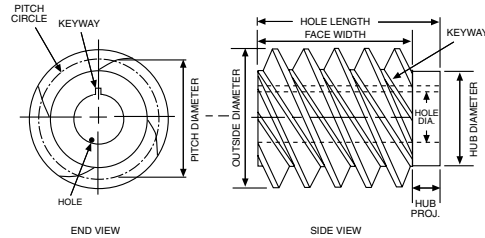

Figure 4.7

Note: Sometimes a pinhole through the hub is required (rather than a keyway). If this is the case, be sure to specify the pin dimensions and location.

WORMS GEARS—BASIC DIMENSIONS

As noted in our discussion of spur gears, gear dimensions are important because they provide valuable information when determining how best to meet a customer's needs. Here are definitions you need to know in order to determine the basic dimensions of worm gears. (See Figure 4.8)

- Pitch Diameter – the diameter of the pitch circle (which, you will remember, is the “imaginary” circle on which the worm and worm gear mesh).
- Working Depth – the maximum distance the worm thread extends into the tooth space of the gear.
- Throat Diameter – the diameter of the throat circle at the center line of the worm gear face (the lowest point on the tooth face).
- Outside Diameter – the largest diameter of the worm gear teeth. It is equal to the diameter of the outside circle.
- Root Diameter – the smallest diameter of the worm gear. It is equal to the diameter of the root circle.

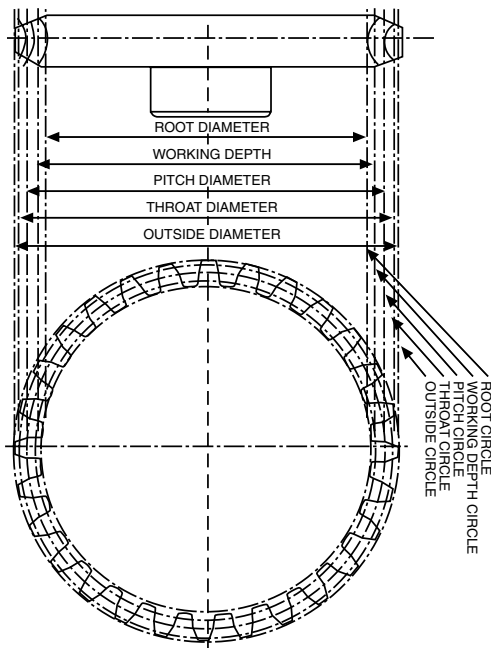

Figure 4.8

Now let's look at the dimensions of the *teeth* on a worm gear.

WORMS GEARS–TOOTH DIMENSIONS

- Addendum – the distance from the pitch circle to the throat circle. (See Figure 4.9)
- Dedendum – the distance from the pitch circle to the base of the tooth. It is equal to the addendum plus the working clearance.
- Whole Depth – the distance between the throat and the base of the tooth. It is equal to the addendum plus the dedendum.
- Working Clearance – the space between the top of the worm thread and the bottom of the worm gear tooth when properly meshed.

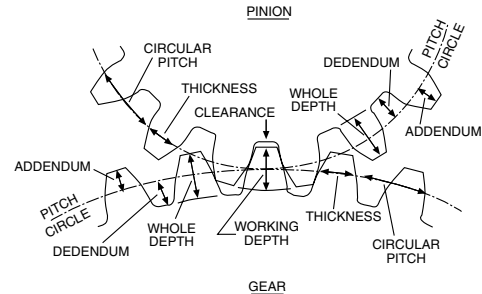

Figure 4.9

SPECIAL ORDER WORM GEARS–PHYSICAL DIMENSIONS

When ordering special order worm gears, the pitch, number of teeth, pressure angle, number of threads, and the pitch diameter of the mating worm should always be specified.

ROTATION AND RATIO

Figure 4.10 indicates the various directions worms and worm gears will rotate depending on their position and hand.

- Changing the position of the worm (above or below the worm gear) changes the relative rotation of the worm gear.
- The direction of rotation using right-hand gearing is shown at the top.
- The direction of rotation using left-hand gearing is shown at the bottom.

The ratio of a mating worm and worm gear is determined by dividing the number of teeth in the worm gear by the number of threads in the worm or:

$$\text{Ratio} = \text{Number of teeth in the worm gear} \div \text{Number of threads in worm}$$

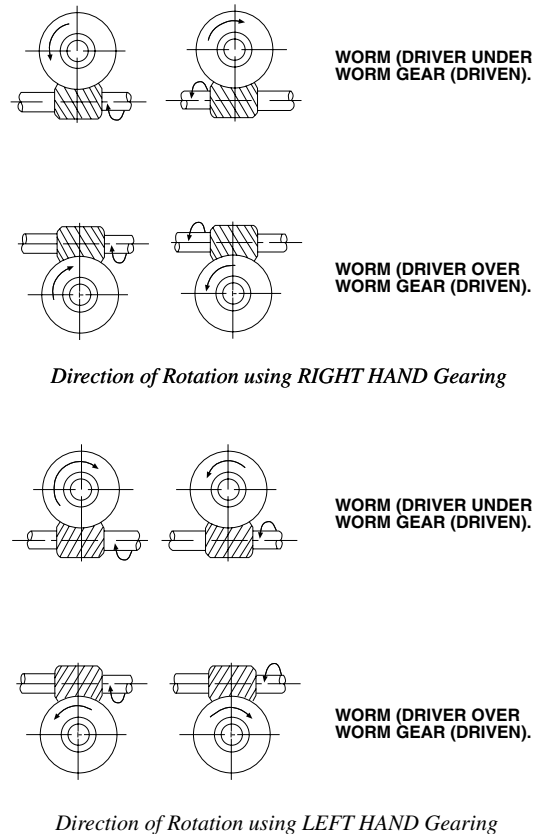

Figure 4.10

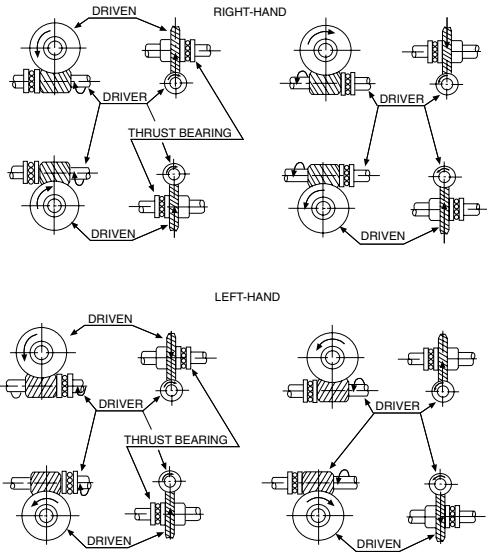

Figure 4.11

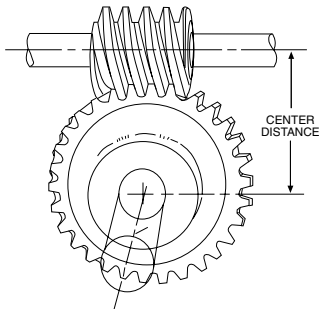

Figure 4.11A

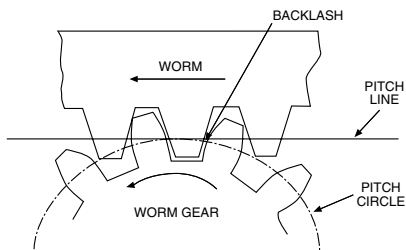

Figure 4.11B

Diametral Pitch	Average Backlash (Inches)	Diametral Pitch	Average Backlash (Inches)
3 DP	.013	8 DP	.005
4 DP	.010	10-12 DP	.004
5 DP	.008	16-48 DP	.003
6 DP	.007		

Figure 4.11C

THRUST

When a worm drives a worm gear, there is a tendency for the worm to “back out” or push forward (depending upon the direction it is rotating) due to the action of the thread. This is known as “thrust action”. To counteract the friction caused by this thrust action, thrust bearings should be used. Thrust bearings should also be used on the worm gear shaft, although thrust is considerably less on the shaft (due to the slower gear rotation.)

Figure 4.11 shows the direction of thrust when worms and worm gears are rotating in various directions. Thrust bearings are shown in their proper position to absorb the pushing force (thrust).

CENTER DISTANCE

The *center distance* of a worm and worm gear *in mesh* is the distance between the center of the two shafts.

When mounted on the proper center distance, the worm and worm gear will mesh correctly. (See Figure 4.11A)

Important: For proper operation, the center distance should be equal to one-half the pitch diameter of the worm plus one-half the pitch diameter of the worm gear.

All Boston gears are cut to run with the correct backlash (see the explanation of “backlash” below) if exact center distances are maintained. If the exact center distance cannot be maintained, it is better to increase the center distance than it is to decrease it.

BACKLASH

Backlash (See Figure 4.11B) is the amount by which the width of a tooth space exceeds the thickness of the engaging tooth on the pitch circles. Backlash may be determined in the transverse, normal, or axial-planes, and either in the direction of the pitch circles or on the line of action. Such measurements should be corrected to corresponding values on transverse pitch circles for general comparisons. (See Figures 4.11C)

Important: The operation of Boston gears at proper center distances assures the correct degree of backlash for greatest efficiency and longest life.

VELOCITY

The *velocity* of a worm gear or worm is the distance that any point on the pitch circle will travel in a given period of time, generally expressed in feet per minute (FPM).

(See Figure 4.12)

Formula: Velocity (FPM) = Pitch Diameter (in inches) x .262 x RPM

WORM AND WORM GEAR EFFICIENCY

The worm and worm gear drive is never 100% efficient as there is always some power loss due to the friction (rubbing action) between the worm and worm gear. The following factors have an impact on the friction and, therefore, the efficiency of a drive:

- Lubrication
- Speed of worm
- Material of worm and gear
- Load
- Finish of surface on worm thread
- Accuracy of cutting worm and gear
- Lead angle of worm

See for yourself: Take a look at figure 4.12A. Note how the efficiency of a worm and worm gear drive increases as the teeth wear in.

FIGURING OUTPUT HORSEPOWER

In order to determine the actual *maximum output horsepower* of any worm and worm gear, you need to know:

- The maximum amount of load in horsepower from the power source
- The efficiency (in terms of a percentage) of the gears

These factors can then be applied to the following formula:

- Output horsepower = Input horsepower x efficiency

Now let's apply the formula to a sample problem.

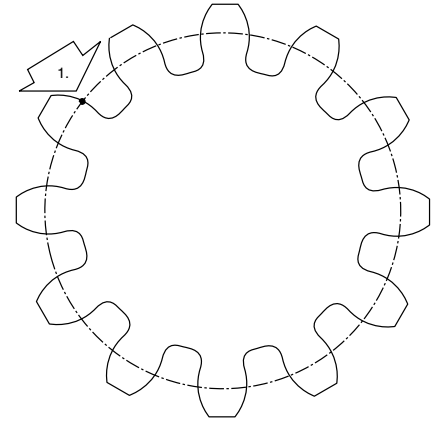

Figure 4.12

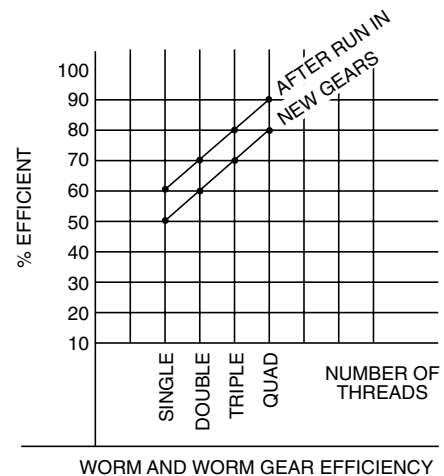

Figure 4.12A

Problem: What is the actual maximum output horsepower available from a quad thread worm and worm gear drive using a 0.5 horsepower motor?

- Output = Input horsepower (HP) x Efficiency
- Output = 0.5 x .90% = .45 Horsepower
- (See figure showing efficiency of a quad thread worm and worm gear after run-in as 90% efficient)
(See Figure 4.12, Page 4-11)

WORM AND WORM GEAR FORMULAS

To Obtain	Having	Rule
Circular Pitch	Diametral Pitch	Divide 3.1416 by the Diametral Pitch.
Diametral Pitch	Circular Pitch	Divide 3.1416 by the Circular Pitch.
Lead (of Worm)	Number of Threads in worm & Circular Pitch	Multiply the Circular pitch by the number of threads.
Circular Pitch or Linear Pitch	Lead and number of threads in worm	Divide the lead by the number of threads
Addendum	Circular Pitch	Multiply the Circular pitch by .3183.
Addendum	Diametral Pitch	Divide 1 by the Diametral Pitch.
Pitch Diameter of Worm	Outside Diameter and Addendum	Subtract twice the Addendum from the Outside Diameter.
Pitch Diameter of Worm	Select Standard Pitch Diameter when Designing	Worm Gears are made to suit the mating worm.
Pitch Diameter of Worm Gear	Circular Pitch and Number of Teeth	Multiply the number of teeth in the gear by the Circular Pitch and divide the product by 3.1416.
Pitch Diameter of Worm Gear	Diametral Pitch and No. of Teeth	Divide the number of teeth in gear by the Diametral Pitch
Center Distance between Worm and Worm Gear	Pitch Diameter of Worm and Worm Gear	Add the Pitch Diameters of the worm and worm gear then divide the sum by 2.
Whole Depth of Teeth	Circular Pitch	Multiply the Circular Pitch by .6866.
Whole Depth of Teeth	Diametral Pitch	Divide 2.157 by the Diametral Pitch.
Bottom Diameter of Worm	Whole Depth and Outside Diameter	Subtract twice the whole depth from the Outside Diameter
Throat Diameter of Worm Gear	Pitch Diameter of Worm Gear and Addendum	Add twice the Addendum to the pitch diameter of the Worm Gear.
Lead Angle of Worm	Pitch Diameter of the Worm and the Lead	Multiply the Pitch Diameter of the Worm by 3.1416 and divide the product by the Lead, the Quotient is the cotangent of the Lead Angle of the Worm.
Ratio	Number of Starts (or threads) in the Worm and the number of teeth in the Worm Gear	Divide the number of teeth in Worm Gear by number of starts (or threads) in worm.

WORM AND WORM GEAR SELECTION

Boston Gear manufactures standard stock worms made from high quality steel (both hardened and unhardened). Depending on pitch, hardened worms are available with *polished only* threads as well as with *ground and polished* threads. Standard stock worm gears are available – depending on pitch – in *fine grain cast iron* and *bronze*.

Approximate input horsepower and output torque ratings for Boston stock worm and worm gear combinations – ranging from 12 to 3 DP – are always illustrated in your Boston Gears catalog.

The ratings shown on chart C.1 (page 4-14) are for *hardened, ground, and polished worms operating with bronze worm gears*. For other combinations, multiply the listed ratings by the following percentages:

- Hardened, ground, and polished steel worms with cast iron gears: 50%
- Unhardened steel (.40 Carbon) worms with cast iron gears: 25%

Take note: These ratings are listed at selected worm speeds. Ratings for intermediate speeds may be estimated, or interpolated from the values indicated.

The ratings reflected on the chart should be satisfactory for gears: 1) operated under normal conditions, 2) properly mounted in accordance with good design practice, and 3) continuously lubricated with a sufficient supply of oil, carrying a smooth load (without shock) for 8 to 10 hours a day. These ratings were established using a mineral oil compounded with 3-10 percent of acid-less tallow. This is a recommended lubrication for worm and worm gear drives.

Important: Extreme Pressure (E.P.) lubricants are not recommended for use with bronze worm gears.

SELECTING A WORM AND WORM GEAR— A SAMPLE PROBLEM

Let's see if we can select a worm and worm gear set using the following information:

- Torque at machine to be driven: 3,211 inch lbs.
- Speed of shaft to be driven: 18 RPM
- Drive motor: 1-1/2 H.P.
- Drive motor speed: 1800 RPM
- Center Distance: 7.000"
- Duty Cycle: 8-10 hrs./day smooth load

STEP 1—FINDING A RATIO

Use the following formula to find the ratio:

- Ratio = RPM of Motor ÷ RPM of Driven Shaft =
1,800 RPM ÷ 18 = 100 to 1

STEP 2—SELECTING THE RIGHT WORM AND WORM GEAR

Using the ratings chart, found in the Boston Gear Open Gearing Catalog, find a worm gear set that meets the following specifications: (*Example chart below*)

- Center Distance: 7.000"
- Ratio: 100 to 1 (as determined above)
- Output Torque: 3,711 inch lbs.
- Input Horsepower: 1-1/2 H.P.

When we check the chart, we find that a GB 8100 bronze worm gear and an H1076 hardened worm with threads ground and polished will satisfactorily meet our specifications.

Ratio	Worm RPM	1800		600		100		Worm Cat. No.	Gear Cat. No.	DP
		Center Distance	Input HP	Output Torque	Input HP	Output Torque	Input HP			
3	1.000	.52	50	.27	72	.06	83	H1607	QB1212	12
	1.500	1.09	109	.66	183	.15	227	H1627	QB812	8
4	1.167	.78	99	.40	143	.08	166	H1607	QB1216	12
	1.425	1.11	142	.61	223	.13	267	H1618	QB1016	10
	1.750	1.77	216	.98	361	.22	454	H1627	QB816	8
	2.333	3.01	392	1.84	699	.45	933	H1638	QB616	6
5	1.333	.68	109	.34	158	.07	180	H1607	DB1600	12
	1.625	1.03	165	.57	257	.12	309	H1618	DB1610	10
	2.000	1.73	264	.96	441	.22	551	H1627	DB1620A	8
	2.667	3.92	639	2.40	1124	.59	1512	H1638	QB620A	6
6	3.000	3.82	746	2.34	1317	.57	1777	H1638	DB1630A	6
	1.750	1.04	247	.53	355	.11	411	H1607	DB1601A	12
7.5	2.125	1.59	381	.87	599	.19	714	H1618	DB1611	10
	2.625	2.65	607	1.47	1016	.33	1276	H1627	DB1621A	8
	3.500	4.80	1174	2.94	2064	.72	2789	H1638	DB1631A	6
10	1.333	.44	130	.23	189	.05	208	H1407	DB1400	12
	1.625	.67	196	.38	305	.09	366	H1418	DB1410	10
	2.000	1.05	318	.63	525	.15	649	H1427	DB1420A	8
	2.167	1.39	441	.71	641	.15	756	H1607	DB1602A	12
	2.667	2.01	616	1.26	1071	.32	1450	H1438	DB620A	6
	2.625	2.11	672	1.16	1061	.25	1267	H1618	DB1612	10
12	3.250	3.54	1082	1.96	1806	.44	2270	H1627	DB1622	8
	4.333	6.43	2094	3.94	3685	.96	4980	H1638	DB1632A	6
12.5	3.000	2.39	882	1.50	1537	.38	2042	H1438	DB1430A	6
	2.583	1.72	683	.87	985	.18	1134	H1607	DB1603A	12
15	3.125	2.61	1042	1.44	1641	.31	1961	H1618	DB1613A	10
	3.875	4.40	1681	2.44	2810	.55	3466	H1627	DB1623A	8
18	1.750	.64	284	.33	410	.07	463	H1407	DB1401A	12
	2.125	.98	436	.55	678	.13	804	H1418	DB1411	10
	2.625	1.54	699	.92	1150	.22	1428	H1427	DB1421A	8
	3.000	2.04	966	1.03	1402	.22	1617	H1607	QB1260A	12
	3.500	2.94	1355	1.84	2364	.47	3120	H1438	DB1431A	6
20	5.000†	2.27	1308	1.38	2373	.41	4198	H1116	G1110†	3
	1.333	.28	140	.15	210	.04	227	H1056	GB1050A	12
	1.625	.42	217	.25	336	.06	391	H1066	GB1060A	10
	2.000	.65	343	.41	567	.10	706	H1076	GB1070	8
	2.167	.83	483	.43	693	.09	794	H1407	DB1402A	12
	2.667	1.22	665	.80	1156	.22	1550	H1086	GB1077A	6
	2.625	1.25	742	.71	1156	.16	1374	H1418	DB1412	10
	3.250	1.98	1191	1.18	1974	.28	2433	H1427	DB1422	8
4.000	2.92	1667	1.99	3025	.64	4663	H1106	GB1100	4	
24	4.333	3.77	2318	2.36	4034	.60	5420	H1438	DB1432A	6
	3.000	1.42	933	.93	1613	.26	2163	H1086	GB1080A	6
25	6.000†	3.23	2218	1.81	4020	.53	7109	H1116	G1111†	3
	4.500	3.41	2336	2.32	4235	.75	6504	H1106	GB1101	4
30	2.583	.99	726	.52	1048	.11	1197	H1407	DB1403A	12
	3.125	1.50	1112	.85	1730	.19	2048	H1418	DB1413A	10
	3.875	2.39	1794	1.43	2962	.34	3671	H1427	DB1423A	8
	5.167	2.27	1738	1.42	3028	.36	4018	H1438	D1433†	6
	1.750	.40	294	.21	410	.05	473	H1056	GB1051	12
	2.125	.59	452	.35	693	.09	831	H1066	GB1061A	10
32	2.625	.90	725	.57	1197	.13	1286	H1076	GB1071	8
	3.000	1.15	1008	.60	1450	.13	1663	H1407	DB1260A	12
	3.500	1.69	1386	1.12	2426	.31	3233	H1086	GB1081A	6
	3.625	1.74	1544	.98	2395	.22	2836	H1418	DB1414A	10
	4.500	2.75	2489	1.65	4128	.39	5105	H1427	DB860A	8
	7.000†	4.23	3326	2.53	6002	.76	10683	H1116	G1112†	3
	5.500	2.13	1955	1.46	3546	.47	5445	H1106	G1102†	4
	4.000	1.95	1915	1.29	3366	.36	4470	H1086	GB1082A	6
36	8.000†	3.87	3990	1.33	4130	.68	12816	H1116	G1113†	3

*Torque in Lb. Ins.
†Cast Iron Gear Rating with Hardened Worm shown.

Chart C.1

Keypoints

- Worm gears are used only on 90 degree non-intersecting shafts
- Worm gears are excellent when higher ratios are needed
- Worm gears become more efficient after a run in period
- Most worm gear sets are available both right and left hand; right hand is considered standard
- Boston Gear worm gear sets can be selected by ratio

Quiz

CLICK HERE or visit <http://www.bostgear.com/quiz> to take the quiz

QUIZ

BEVEL AND MITER GEARS

5



COMMON APPLICATIONS:
Bevel and miter gears are commonly used in dairy equipment, ag. equipment and food processing machinery

CATALOG CHECK:
The Boston Gear Advantage:
While there are many types of bevel and miter gears to choose from, most manufacturers supply them by special order only. Not Boston Gear! Boston Gear customers get to select from a stock line of 382 catalog numbers. This makes it easier – and less costly – for designers because they are able to standardize the specifications of their applications. Furthermore, Boston's stock line of bevel and miter gears is readily available through local distributors, thus minimizing discontinuance and replacement problems.

When an application calls for the transmission of motion and/or power between shafts that intersect at right angles (90-degrees), bevel gears and miter gears are often the “way to go”. Let's learn more about them.

A **bevel gear** is shaped like a section of a cone. Its teeth may be straight or spiral. (If they are spiral, the pinion and gear must be of opposite hand to run together.) Because bevel gears are used to reduce speed, the pinion always has fewer teeth (see discussion of ratios below). (See *Figure 5.1*)

Miter gears differ from bevel gears in one very significant way: they are *not* used to change speed. In a miter gear set, therefore, both gears always have the same number of teeth and a ratio of 1:1. (See *Figure 5.1A*)

THE BOSTON GEAR LINE

Boston Gear manufactures a complete line of standard stock bevel and miter gears for the transmission of motion and/or power between intersecting shafts at right angles (90 degrees). As noted above, miter gears are always configured in a 1:1 ratio between the gear and pinion; stock bevel gears are available in ratios ranging from 1-1/2:1 to 6:1.

Boston miter and bevel gears are available with straight and spiral teeth. Straight tooth miter and bevel gears are suitable for many applications, though they are not usually recommended when high speeds are required. In high speed applications, spiral tooth miter and bevel gears are recommended because they run more smoothly and usually will transmit more horsepower than their straight tooth counterparts.



*Figure 5.1,
Straight Bevel-iron and steel*



*Figure 5.1A,
Straight Miter-cast iron and steel*

Important: Because *spiral* miter and bevel gears of the same hand will not operate together, a set of spiral bevel or miter gears consists of one left-hand gear and one right-hand gear.

BEVEL AND MITER GEARS—THE SIZE SYSTEM

Boston miter and bevel gears are listed in your catalog according to their *diametral pitch*, a term you should be familiar with by now. As you will recall, the diametral pitch (also referred to as *pitch*) indicates the size of a gear tooth. On miter and bevel gears, that tooth size is measured on the large end of the tooth. (See Figure 5.2)

Important: Both gears in a miter or bevel gear set must be of the same pitch.

The following formula is used to determine diametral pitch.

Pitch (D.P.) = Number of Teeth ÷ Pitch Diameter
 This concept is reviewed below. (See Figure 5.2A)

CIRCULAR PITCH

In our lessons on spur, helical and worm gears, we learned how to calculate circular pitch. Now let's see how the circular pitch of bevel and miter gears are calculated.

Circular pitch (p) is the distance – along the pitch line or circle – from any point on a gear tooth to the corresponding point on the next tooth. It is also equal to the circumference of the pitch circle divided by the number of teeth. (See Figure 5.2B)

The formula for determining circular pitch (p) follows:

- $p = \pi d$ (where d (or D) = the pitch diameter) ÷ n (where n (or N) = the number of teeth)

Example: To determine the circular pitch (p) of a 48-tooth gear (n) with an 8-inch pitch diameter (d):

$$p = 3.1416 \times 8 \div 48 = 25.1328 \div 48 = .5236 \text{ inches}$$

Note: Gears of larger circular pitch have larger teeth than gears of smaller circular pitch.

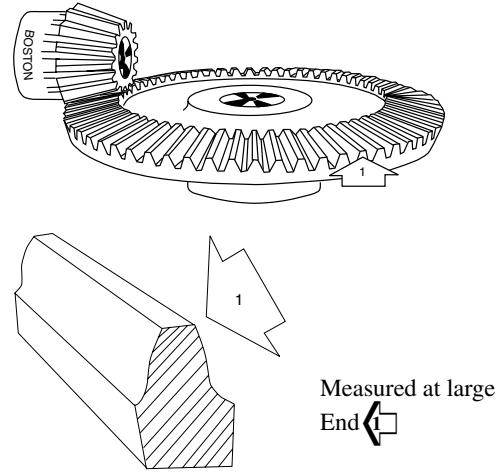

Figure 5.2

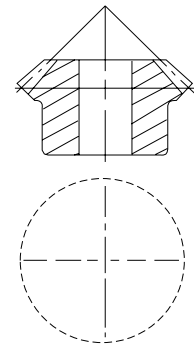

Figure 5.2A, A gear with a 1" P.D. and 24 teeth is 24 Pitch (Tooth Size).

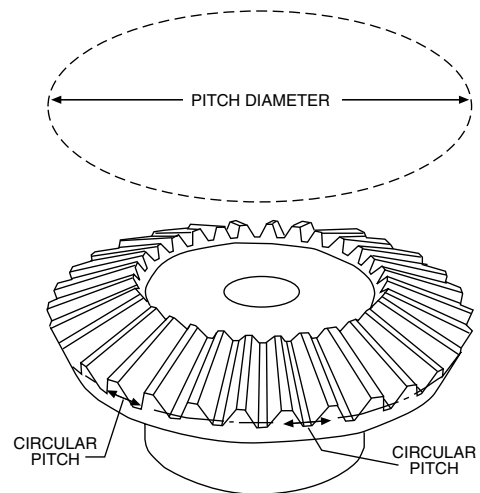

Figure 5.2B

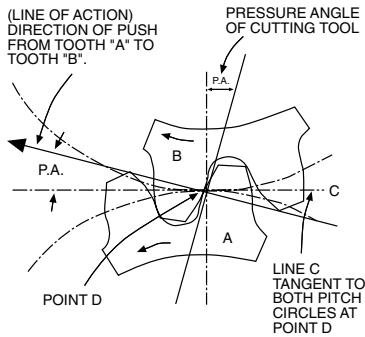

Figure 5.3

PRESSURE ANGLE

The pressure angle of a gear is the angle between the line of action (the direction of push from tooth A to tooth B) and the line tangent to the pitch circles of mating gears. A gear’s pressure angle also corresponds to the pressure angle of the cutting tool used to create the teeth. (See Figure 5.3)

Important: In a gear set, both gears must have the same pressure angle.

PITCH DIAMETER

The pitch diameter is the diameter of the pitch circle. On both miter and bevel gears, the pitch diameter is measured on the pitch circle – at the large end of the teeth. The formula for determining the pitch diameter follows:

- Pitch Diameter (P.D) = Number of Teeth ÷ Pitch (D.P)
(See Figure 5.4)

TOOTH PARTS

Tooth parts and dimensions are important because they provide valuable information when quoting customer gearing. Let’s review the parts of a miter or bevel gear’s tooth by learning their definitions and referring to Figure below. (See Figure 5.5 on Page 5-5)

- Addendum – the distance the tooth projects above, or outside of, the pitch line or circle
- Dedendum – the depth of a tooth space below, or inside of, the pitch line or circle. (Note: In order to provide clearance, the dedendum is usually greater than the addendum of the mating gear tooth.)
- Clearance – the amount of space by which the dedendum of a gear tooth exceeds the addendum of a mating gear tooth.
- Whole Depth – the total height of a tooth, including the total depth of the tooth space.
- Working Depth – the depth of the teeth of two mating gears at the point at which the teeth mesh. Working depth is also equal to the sum of the teeth’s addenda.

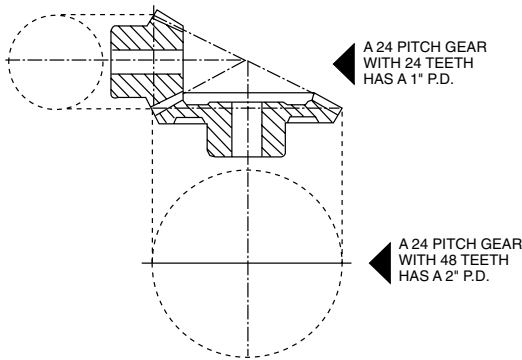

Figure 5.4

- Tooth Thickness – the distance (along the pitch line or circle) from one side of the gear tooth to the other. It is nominally equal to one-half the circular pitch. (Note: The difference between circular pitch and tooth thickness is the width of the space between the teeth that is necessary to accommodate a tooth of the mating gear.
- Face – the length of the tooth.

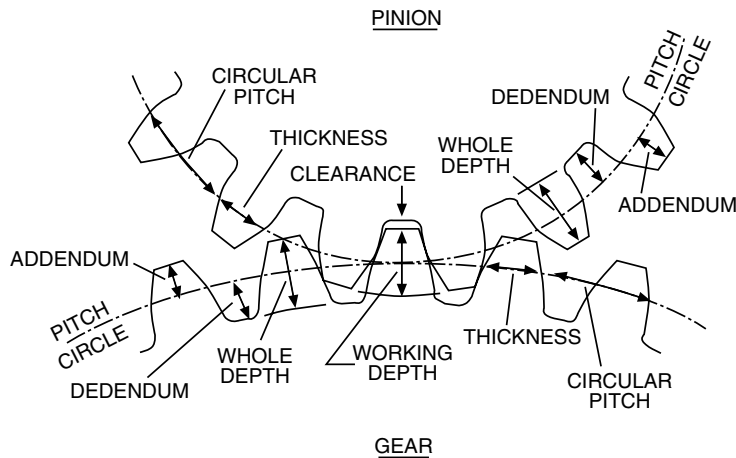

Figure 5.5

BEVEL AND MITER GEARS – CONIFLEX TOOTH FORM

Straight tooth bevel and miter gears cut with a generated tooth form having a localized lengthwise tooth bearing are referred to as having a *Coniflex™* tooth form. Bevel gears with a *Coniflex™* tooth form provide greater control of tooth contact than straight bevels cut with full-length tooth bearings. The “localization” of contact permits the minor adjustment of the gears in assembly and allows for some displacement due to deflection under operating loads – without concentration of the load on the end of the tooth. The result: increased life and quieter operation, (See Figure 5.6) The long and short addendum system for gears and pinions is used to reduce the undercut of the pinion and to more nearly equalize the strength and durability of gear and pinion.

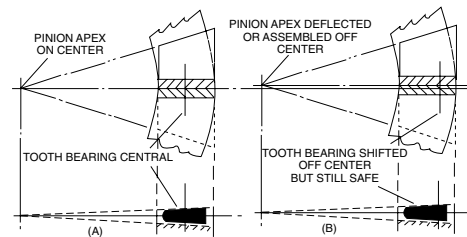

Figure 5.6

FORMULAS FOR DETERMINING GEAR DIMENSIONS

The following formulas on Chart 1 will help you find the dimensions of various parts of bevel and miter gears.

STRAIGHT BEVEL & MITER GEAR DIMENSIONS - 90° SHAFT ANGLE				
	TO FIND	HAVING	RULE	
			PINION	GEAR
1	Ratio	No. of teeth in Pinion and Gear	Divide the Number of Teeth in the Gear by the Number of Teeth in the Pinion	
2	Diametral Pitch (D.P.)	Circular Pitch	Divide 3.1416 by the Circular Pitch	
3	Pitch Diameter	Numbers of Teeth & Diametral Pitch	Divide Number of Teeth in the Pinion by the D.P.	Divide Number of Teeth in the Gear by the D.P.
4	Whole Depth	Diametral Pitch	Divide 2.188 by the Diametral Pitch and add .002	
5	Addendum*	Diametral Pitch	Divide 1 by the Diametral Pitch	Divide 1 by the Diametral Pitch
6	Dedendum †	Diametral Pitch and Addendum	Divide 2.188 by the D.P. and subtract the Addendum	Divide 2.188 by the D.P. and subtract the Addendum
7	Clearance	Diametral Pitch	Divide .188 by the Diametral Pitch and add .002	
8	Circular †† Thickness	Diametral Pitch	Divide 1.5708 by the Diametral Pitch	Divide 1.5708 by the Diametral Pitch
9	Pitch Angle	No. of Teeth in Pinion and Gear	Divide No. of Teeth in Pinion by No. of Teeth in Gear. Quotient is the tangent of the Pitch Angle	Subtract the Pitch Angle of Pinion from 90°
10	Cone Distance	P.D. and Pitch Angle of Gear	Divide one half the P.D. of the Gear by the sine of the Pitch Angle of the Gear	
11	Dedendum Angle	Dedendum of Pinion and Gear and Cone Distance	Divide the Dedendum of Pinion by Cone Distance. Quotient is the Tangent of the Dedendum Angle	Divide the Dedendum of Gear by Cone Distance. Quotient is the tangent of the Dedendum Angle
12	Root Angle	Pitch Angle and Dedendum Angle of Pinion and Gear	Subtract the Dedendum Angle of pinion from Pitch Angle of the Pinion	Subtract the Dedendum Angle of the Gear from Pitch Angle of the Gear
13	Face Angle	Pitch Angle & Dedendum Angle of Pinion & Gear	Add the Dedendum Angle of the Gear to the Pitch Angle of the Pinion	Add the Dedendum Angle of the Pinion to the Pitch Angle of the Gear
14	Outside Diameter	P.D., Addendum & Pitch Angles of Pinion & Gear	Add twice the Pinion Addendum times cosine of Pinion Pitch Angle to the Pinion P.D.	Add twice the Gear Addendum times cosine of Gear Pitch Angle to the Gear P.D.
15	Pitch Apex to Crown	Pitch Diameter Addendum and Pitch Angles of Pinion and Gear	Subtract the Pinion Addendum, times the sine of Pinion Pitch Angle from half the Gear P.D.	Subtract the Gear Addendum times the sine of the Gear Pitch Angle from half the Pinion P.D.

The face width should not exceed one-third of the cone distance, or 10 inches divided by the Diametral Pitch, whichever is smaller.

†These Dedendum values are used in other calculations. The actual Dedendum of Pinion and Gear will be .002 greater.

*Addendum and †† Circular Thickness obtained from these rules will be for *equal* Addendum Pinions and Gears. The values of these dimensions for 20° P.A. *long* Addendum Pinions and *short* Addendum Gears may be obtained by dividing the values in Table (P), corresponding to the Ratio, by the Diametral Pitch.

PHYSICAL DIMENSIONS

Using Chart 2, determine the physical dimensions of a Boston Straight Miter Gear No. HLK105Y.

STRAIGHT MITER GEARS

Pitch Dia.	Teeth	Face	Hole	D	MD +	Hub		Steel-Hardened with Keyway & Setscrew		Steel-Unhardened without Keyway & Setscrew	
						Dia.	Proj	Cat. No.	Item No.	Cat. No.	Item N
12 PITCH											
1-1/4"	15	.27"	3/8"	55/64"	1.250"	1"	1/2"	—	—	L125Y	12204
			7/16					—	—	L126Y	12206
			1/2					HLK101Y	12328	L101Y	12154
1-1/2	18	.32	1/2	1-1/64	1.500	1-1/4	5/8	—	—	L127Y	12208
			5/8					HLK102Y	12330	L102Y	12158
1-3/4	21	.39	1/2	1-3/16	1.750	1-3/8	11/16	—	—	L119Y*	12190
			9/16					—	—	L120Y	12192
			5/8					HLK121Y	12334	L121Y	12194
			3/4					—	—	L133Y	12218
2	24	.43	1/2	1-7/32	1.875	1-5/16	11/16	—	—	L113Y	12178
2-1/2	30	.54	5/8	1-31/64	2.312	1-5/8	27/32	HLK114Y	12332	L114Y	12180
8 PITCH											
3	24	.64	3/4	1-37/64	2.562	1-3/4	13/16	HLK115Y	12366	L115Y	12182
3	24	.64	1	1-49/64	2.750	2-1/2	1-1/6"	HLK105Y-A	12362	L105Y-A	12164
3-1/2	28	.75	7/8	1-23/32	2.875	2	7/8	—	—	OA828Y-1‡	12418
3-1/2	28	.75	1	2-3/32	3.250	2-1/2	1-1/4	HLK117Y	12370	L117Y	12186
			1-3/16					HLK132Y	12374	L132Y	12196
			1-1/4					HLK106Y	12364	L106Y	12166
4	32	.84	7/8	2-3/32	3.438	2-1/4	1-1/8	—	—	OA832Y-1‡	12420
4	32	.84	1	2-9/32	3.875	3	1-1/8	HLK123Y	12372	L123Y	12000

Chart 2

You should have come up with the following dimensions:

- Face = .64"
- Hole Diameter = 1"
- "D" dimension = 1 49/64" (Hole Length)
- MD dimension = 2 3/4" (Mounting Distance)
- Hub Diameter = 2 1/2"
- Hub Projection = 1 1/16"

SELECTION GUIDE

Here is another guide to help you determine the various specifications of a gear. (See Chart 3)

TO FIND		RULE	SOLUTION
1	Ratio	Divide the Number of Teeth in the Gear by the Number of Teeth in the Pinion	Teeth in Gear 48 Teeth in Pinion 24 $48 \div 24 = \text{ratio } 2:1$ Ratio = 2:1
2	Diametral Pitch (DP)	Divide 3.1416 by the Circular Pitch	Circular Pitch .2618" $3.1416 \div .2618 = 12$ Diametral Pitch (DP) 12
3	Pitch Diameter of <i>Pinion</i>	Divide Number of Teeth in the Pinion by the D.P.	Number of Teeth in Pinion 24 D.P. (Diametral Pitch) 12 $24 \div 12 = 2"$ Pitch Diameter
	Pitch Diameter of <i>Gear</i>	Divide Number of Teeth in the Gear by the D.P.	Number of Teeth in Gear 48 Diametral Pitch 12 $48 \div 12 = 4"$ Pitch Diameter
4	Whole Depth (of Tooth)	Divide 2.188 by the Diametral Pitch and add .002	Diametral Pitch (DP) = 12 $\frac{2.188}{12} + .002 = .1843"$ Whole depth of Tooth = .1843"
5	Addendum for <i>Pinion</i>	Having Ratio Use Table "P" and Divide by Pitch	Ratio = 2 to 1 From Chart "P" <i>Pinion</i> addendum for 1 Diametral Pitch = 1.350" $1.350 \div 12 = .1125$ <i>Pinion</i> Addendum = .1125"
	Addendum for <i>Gear</i>	Having Ratio Use Table "P" and Divide by Pitch	Ratio = 2 to 1 From Chart "P" <i>Gear</i> Addendum for 1 Diametral Pitch = .650" $.650 \div 12 = .0541"$ <i>Gear</i> Addendum = .0541"
6	Dedendum of <i>Pinion</i>	Divide 2.188 by the DP and Subtract the Addendum	DP = 12 Addendum of <i>Pinion</i> = .1125" $\frac{2.188}{12} - .1125 = .0698"$ Pinion Dedendum = .0698"
	Dedendum of <i>Gear</i>	Divide 2.188 by the DP and Subtract the Addendum	DP = 12 Addendum of <i>Gear</i> = .0541" $\frac{2.188}{12} - .0541 = .1282"$ Gear Dedendum = .1282"

Chart 3

THRUST

In previous chapters, we discussed how thrust (the driving force or pressure) affects the operation of various types of gears. Now let's see how thrust should be addressed when applications call for the use of bevel and miter gears.

THRUST OF STRAIGHT-TOOTH BEVEL OR MITER GEARS

When a pair of straight tooth bevel or miter gears runs together, they have a tendency to push each other apart. This pushing action – thrust – is always backward toward the hub. (See Figure 5.7A)

THRUST OF SPIRAL-TOOTH BEVEL AND MITER GEARS

Thrust is a very important consideration when it comes to the operation of spiral miter gears. Why? With spiral miter gears there is a backward thrust on one gear and a forward thrust on the mating gear (depending upon the rotation direction and gear hand). The *sudden stopping of a pair of spiral miter gears causes a momentary reversal of thrust*. (See Figure 5.7B)

To prevent the hub of the gear from rubbing against an adjoining surface, thrust bearings or washers should be mounted on the shaft – in back of the hub – to absorb the thrust load.

Since spiral miter gears have both forward and backward thrust – depending upon the direction of rotation – provision must be made to absorb this thrust. Often this is accomplished through the use of *combination radial-thrust bearings*. (See Figure 5.7C)

DIRECTION OF ROTATION

A pair of bevel or miter gears will rotate in opposite directions (as viewed from the hub end of the two gears). Thus, as bevel or miter gears transmit motion around a 90-degree corner, one will rotate clockwise and the other counterclockwise. (See Figure 5.7D)

CATALOG CHECK!: Thrust Bearings for Bevel and Miter Gears Boston Gear manufactures a variety of bearings to absorb thrust, including Bost-Bronz thrust type bearings, AO steel and SOA stainless steel (for light loads) bearings. Check out the Gears catalog.

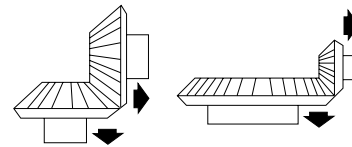

Figure 5.7A

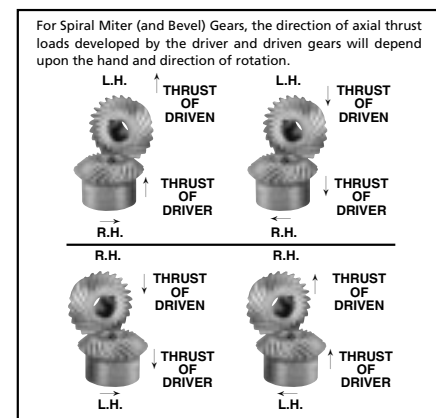

Figure 5.7B

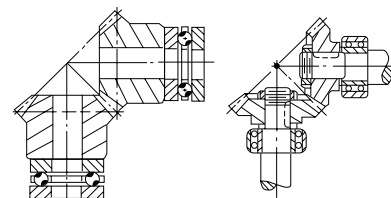

Figure 5.7C

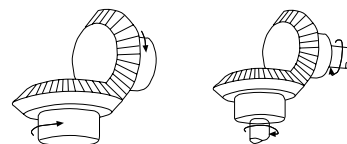

Figure 5.7D

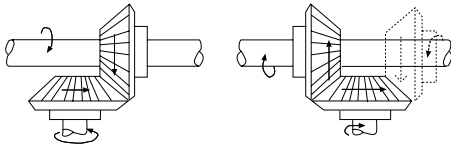

Figure 5.8

Take Note: By changing the driven gear from one side of the driver to the opposite side, the rotation of the shaft will be reversed (in both open and enclosed bevel gearing). This is important to remember whenever shaft rotation is important to an application. (See Figure 5.8)

RATIO

Ratio may be determined when any of the following factors is known:

- Numbers of Teeth (T)
- Pitch Diameters (PD)
- Revolutions per Minute (RPM)

GEAR RATIO—QUANTITY OF TEETH

The gear ratio is the number of teeth on the gear divided by the number of teeth on the pinion. It is always the larger number of teeth (as found on the gear) divided by the smaller number of teeth (as found on the pinion). Thus, the ratio of a pair of gears with 72 teeth on the gear and 18 teeth on the pinion is 4 to 1.

Now let's apply those factors to some sample problems.

Problem: Find the ratio of a pair of bevel gears with a 15-tooth pinion and a 60-tooth gear.

- Ratio = Number of Teeth in Large Gear (60) ÷ Number of Teeth in Small Gear (15)
- $60 \div 15$, or
- 4 to 1

VELOCITY

Velocity (V) is distance traveled in a given time, usually noted in feet per minute (FPM). Velocity is determined by dividing the distance (feet) traveled by the time (minutes) required to travel that distance.

- Velocity (in ft. per min.) = Distance (in feet) ÷ Time (in minutes)



Important: When referring to gears, velocity usually means pitch line velocity or the velocity of a particular point on the pitch line or circle. Gear speed is usually given in revolutions per minute (RPM), and in each revolution a point on the pitch circle moves a distance equal to the circumference of the pitch circle. The pitch line velocity, then, equals the circumference multiplied by the RPM.

As the circumference is πD inches, then:

- $\pi D \div 12$ feet, or $.262D$ (feet)
- $V = .262D \times \text{RPM}$

Sample Problem: Calculate the velocity of a gear with a pitch diameter of 4.5" turning at 800 RPM.

Velocity (V) = $.262D \times \text{RPM} = .262 \times 4.5 \times 800 = 943$ FPM

LUBRICATION

As emphasized throughout our introduction to Gearology, gears should be lubricated to minimize wear, prevent excessive heat generation, and improve efficiency by reducing friction between the surfaces of mating teeth. Lubrication also tends to reduce noise and retard the formation of rust (oxidation).

Good lubrication depends on the formation of a film thick enough to prevent contact between the mating surfaces. The relative motion between gear teeth helps to produce the necessary film from the small wedge formed adjacent to the area of contact.

It is important that an *adequate supply* of the *correct lubricant* is *properly applied*. Keep the following lubrication guidelines in mind:

- The use of a straight mineral oil is recommended for most straight tooth bevel and miter gear applications.
- Mild extreme pressure (E.P.) lubricants are suggested for use with spiral miter and bevel gears or heavily loaded straight tooth gears.
- Extreme pressure lubricants are recommended for spiral miter gears subjected to heavy loads and/or shock conditions.
- SAE80 or SAE90 gear oil should be satisfactory for splash lubricated gears. Where extremely high or low speed conditions are encountered, consult a lubricant manufacturer. An oil temperature of 150° F should not be exceeded for continuous duty applications. Oil temperatures up to 200° F can be safely tolerated for short periods of time.

SELECTING THE RIGHT MITER AND BEVEL GEARS

To select the correct bevel or miter gears for any application, the following must be known:

- Horsepower required to be transmitted by gears
- Pinion (driver – high speed) shaft RPM
- Gear (driven – slow speed) shaft RPM
- Ratio required
- Mounting distance of gear and pinion
- Space limitations (if any)
- Duty cycle

NOTE: Duty cycle refers to the operating conditions.

The bevel and miter gear ratings in your Boston Catalog should be satisfactory for gears that are properly mounted, properly lubricated, and carrying a smooth load (without shock) for 8 to 10 hours a day.

SELECTING THE RIGHT MITER OR BEVEL GEARS—A SAMPLE PROBLEM

(See Chart 4)

Let's see if we can select the right bevel gear using the following information:

- HP to be transmitted by gears: 2.5
- Pinion (driver – high-speed) shaft RPM: 300
- Gear (driven – slow-speed) shaft RPM: 100
- Ratio required (to be determined in Step 1 below)
- Mounting distance of pinion: 5-7/8"
- Mounting distance of gear: 3-3/4"
- Duty Cycle: Normal – 8 to 10 hours per day smooth load (without shock).

Step 1 – Finding the Required Ratio

Use the following formula to determine the ratio:

- Ratio = High speed shaft RPM ÷ Low speed shaft RPM, or
- 300 ÷ 100 = 3
- Ratio required: 3 to 1

Step 2 – Selecting the Right Bevel Gear

Referring to the "Approximate Horsepower Ratings for Bevel Gears" heading on the facing chart (taken from your Boston Gears catalog), find the 300 RPM column. Go down the column until you find bevel gears strong enough to transmit 2.5 HP, keeping in mind that the ratio of your gears must be 3:1, as we figured above. If you have followed along correctly, you have selected a PA935Y gear.

Step 3 – Checking the Selection in Your Catalog

Find the page in your Boston Gears catalog that lists the specifications of PA935Y bevel gears. Here's what you should find:

Pinion (Steel)

- Number of Teeth: 15
- Pitch Diameter: 3"
- Hole: 1"
- Mounting Distance: 5-7/8"

Gear (Cast Iron)

- Number of Teeth: 45"
- Pitch Diameter: 9"
- Hole Size: 1-1/4"
- Mounting distance: 3-3/4"

BOSTON BEVEL GEARS

Approximate Horsepower Ratings		Steel & Iron									
		Pressure Angle 20°									
Ratio	Revolutions per Minute of Pinion										Cat. No.
	50	100	200	300	450	600	900	1200	1800	Pitch	
2:1	.26	.50	.99	1.5	2.2	2.8	4.2	5.5	8.0	8	SS82
	.40	.75	1.3	1.8	2.4	2.9	3.5	4.0	—	6	PA626Y
	.43	.82	1.5	2.0	2.6	3.1	3.8	4.3	—	5	PA625Y
	.34	.67	1.3	2.0	2.9	3.8	5.6	7.3	10.7	10	SH102
	.48	.89	1.6	2.1	3.2	3.9	—	—	—	6	PA726Y
	.59	1.1	2.0	2.7	3.6	4.2	5.2	5.9	—	6	L158Y
	.63	1.2	2.0	2.7	3.4	4.0	4.8	—	—	6	PA826Y
	.44	.88	1.7	2.5	3.8	4.9	7.3	9.5	13.8	8	HL156Y
	.64	1.3	2.5	3.7	5.4	7.1	10.5	13.7	20.0	8	SH82
	.98	1.8	3.2	4.2	5.4	7.3	7.5	—	—	4	PA824Y
3:1	.77	1.5	3.0	4.4	6.5	8.5	12.5	16.4	23.8	6	HL158Y
	2.1	3.8	6.4	8.4	10.5	12.0	—	—	—	3	PA1023Y
	.02	.04	.08	.11	.16	.20	.27	.33	.42	16	PA3116Y
	.06	.12	.22	.31	.43	.53	.70	.83	1.0	12	PA45312Y
	.13	.24	.45	.63	.85	1.0	1.3	1.5	1.8	10	PA6310Y
	.16	.31	.57	.79	1.1	1.3	1.7	2.0	2.3	8	PA638Y
	.19	.36	.67	.94	1.3	1.6	2.0	2.3	2.8	10	L157Y
	.33	.62	1.1	1.6	2.1	2.5	3.1	3.6	—	6	PA7536Y
	.57	1.1	1.9	2.6	3.4	4.1	5.0	5.7	—	5	PA935Y
	.87	1.6	2.9	3.9	5.0	5.9	7.1	—	—	4	PA10534Y
4:1	.02	.05	.09	.13	.18	.23	.32	.38	.49	16	PA4416Y
	.06	.12	.23	.33	.45	.56	.74	.87	1.0	12	PA6412Y
	.08	.16	.30	.43	.59	.73	.92	1.1	1.4	10	PA6410Y
	.16	.31	.58	.81	1.1	1.3	1.7	2.0	—	8	PA848Y
	.28	.54	1.0	1.4	1.9	2.2	2.8	3.3	—	8	PA948Y
	.38	.72	1.3	1.8	2.4	2.9	3.6	4.1	—	6	PA1046Y
	.76	1.4	2.6	3.5	4.6	5.4	6.6	7.5	—	5	PA1245Y
	1.1	2.0	3.5	4.7	6.1	7.1	8.6	—	—	4	PA1444Y
6:1	.03	.07	.13	.18	.26	.33	.44	.54	.69	16	PA6616Y
	.05	.09	.17	.25	.36	.45	.61	.75	.96	12	PA6612Y
	.11	.21	.40	.56	.78	.96	1.3	1.5	1.8	10	PA9610

Chart 4

Keypoints

- Miter gears are always 1:1 ratio
- Bevel gears range from 1.5:1 to 6:1 ratio
- Miters and bevels are for 90° applications only
- Spiral miter and bevel gears are more suitable for higher speed applications
- Miter and bevel gears are measured on the large end of the tooth when using a gear gauge
- Boston Gear miter and bevel gears are made to the Coniflex™ tooth form

Quiz

CLICK HERE or visit <http://www.bostgear.com/quiz> to take the quiz

QUIZ

700 SERIES WORM GEAR SPEED REDUCERS

6



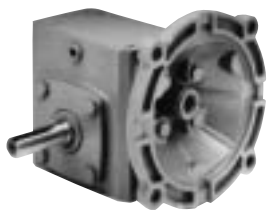

Figure 6.1

This is our introduction into Boston Gear's speed reducer line. Boston Gear has many types of speed reducers.

They are the 700 Series right angle worm gear and the 200, 600 and 800 Series helical speed reducers.

The purpose of an enclosed gear drive is to reduce the input speed coming from the prime mover, usually an AC or DC motor, to a slower speed output through a gear reduction.

The term "enclosed gear drive" comes from the fact that the gears are contained in some type of an enclosure with all the necessary lubricant. The enclosure protects the machine operator from injury.

Boston Gear has manufactured a line of stock off-the-shelf speed reducers since 1923, the latest of which is the expanded line of Boston's 700 Series. This lesson will acquaint you with the exclusive features of the 700 Series line, and provide you with the data you will need with regard to numbering systems, interchangeability and selection.

BOSTON GEAR 700 SERIES

Boston Gear's 700 Series worm gear speed reducers are available in a complete range of types and sizes. Designed especially for heavy-duty industrial applications, the high-pressure angle, integral worm and shaft of 700 Series models provide maximum torque ratings and power transmission efficiency. (See Figure 6.1)

Now let's look at some of the unique features of the 700 Series. (See Figure 6.2)

There are four types of reducers in Boston's 700 Series:

- Basic reducer
- RF model (coupling type input)
- F model (quill type input) for use with N.E.M.A. "C" face mounted motors.
- Bost Mount-Hollow Output Bore

The 700 Series comes in eleven basic sizes:

- Center distances range from 1" – 6"
- Horsepower ratings range from 1/6 HP – 25 HP

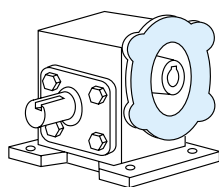

QUILL TYPE

NEMA C-Face
Hollow input shaft with keyway to accept motor shaft and key.

PREFIX — "F"

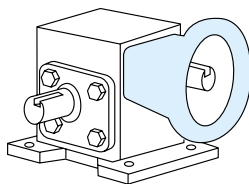

COUPLING TYPE

NEMA C-Face
Solid projecting input shaft with keyway.
Coupling shipped with reducer for motor shaft connection

PREFIX — "RF"

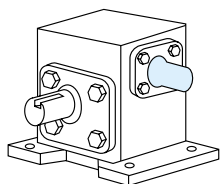

NO MOTOR FLANGE

Solid projecting input shaft with keyway and key.

NO PREFIX

HOLLOW SHAFT

Available in several sizes.
Keyway through the bore.

PREFIX — "S" or "H"
Before "F" or "RF" or just "S"
or "H" for no motor flange

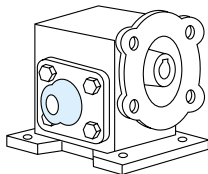

Figure 6.2

700 Series models are available from stock in the following ratios:

- Single reduction models, from 5:1 – 60:1 (6.3A, 6.3B)
- Double reduction models, from 100:1 – 3600:1. (6.4)

CONSTRUCTION FEATURES

(See Figure 6.5)

- A. Rugged housing of fine-grained, gear-quality cast iron provides maximum strength and durability. Greater rigidity and one-piece construction ensure precise alignment of the worm and gear. This housing construction also provides superior resistance to caustic washdown solutions, plus high heat dissipation and reduced noise level. Pipe plugs allow easy fill, level and drain in any mounting position.
- B. Housings are straddle-milled top and bottom for precise alignment of horizontal and vertical bases.
- C. Multi-position mounting flexibility – threaded bolt holes let you install 700 Series speed reducers in almost any position.
- D. Internal baffle assures positive leak-free venting.
- E. Large oil reservoir provides highly efficient heat dissipation and lubrication for longer operating life.
- F. High pressure angle on worm provides greater operating efficiency.
- G. Integral input worm and shaft design made from high-strength case-hardened alloy steel. Reduced sizes 710 through 726 have pre-lubricated bearings; 732 through 760 have tapered roller bearings. Double lip oil seals are standard.
- H. Super-finished oil seal diameters on both input and output shafts provide extended seal life.
- I. High strength steel output shaft assures capacity for high torque and overhung loads.
- J. High-strength bronze worm gear is straddle mounted between heavy-duty tapered roller bearings to increase thrust and overhung load capacities, sizes 713-760.



F700 BASIC

Figure 6.3A



700 BASIC

Figure 6.3B



F/RFWA700 BASIC

Figure 6.4

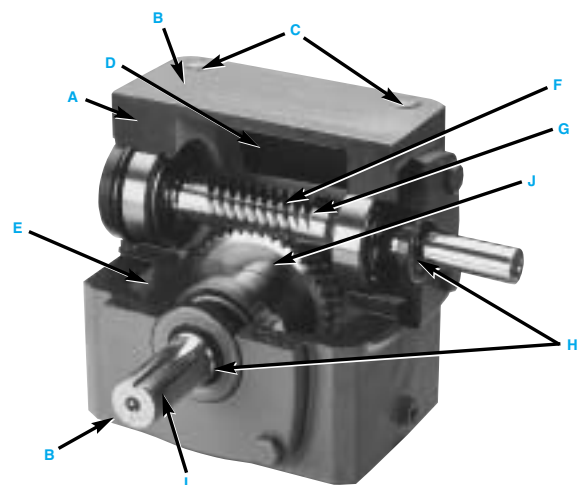

Figure 6.5



Figure 6.6



Figure 6.7

WORM GEAR

700 Series worm gears feature precision generated gear teeth for smooth, quiet operation. Thrust and overhung load capacities are enhanced by straddle mounting the high strength bronze worm gear between heavy duty tapered roller bearings.

SERIES 700 OPTIONS INCLUDE:

- Double oil seals on input and output shaft for special applications
- Fan kit for larger sizes to enhance cooling
- Riser blocks for increased motor clearance and extended reducer life
- Choice of vertical or horizontal bases
- Motor flange kit for standard NEMA C-face motors
- Reaction rod kit for hollow output shaft models
- BISSC approved white and stainless steel washdown units
- Multiple output bores available for Bostmount series

700 SERIES—DEFINITIONS AND TYPES

A geared speed reducer – like those in Boston Gear’s 700 Series – is a packaged unit of gears, shafts and bearings assembled in a housing containing lubricant. A geared speed reducer is designed for both the reduction of speed and the transmission of power.

The 700 Series is available in both single-reduction and double-reduction models.

The basic difference in a single reduction and a double reduction speed reducer is the ratio. Single reduction (See Figure 6.6) speed reducers have a ratio range from 5:1 to 60:1. Double reduction can achieve higher reduction ratios (100:1-3600:1) by adding an additional single speed reducer to the input shaft of the primary gearbox. Therefore the ratios of the primary and secondary reducers are multiplied and the output speed is a product of the two. For example, the first reduction could be 50:1 and the second reduction could be 60:1. The end result would be a 300:1.

SINGLE REDUCTION: RF MODEL COUPLING TYPE AND F-MODEL QUILL TYPE

Boston Gear's coupling long flange (RF model) and quill short flange (F model) single-reduction speed reducers are available in reduction ratios ranging from 5:1 to 60:1, and will accommodate motor inputs from 1/6 to 20 hp. The RF model has a self-positioning, two-piece steel coupling input with a straddle-mounted double-bearing support, and is available with a standard NEMA C-face and coupling. (See Figure 6.8) The F-type is designed with a hollow input shaft suitable for assembly with NEMA C-face motors. (See Figure 6.9)

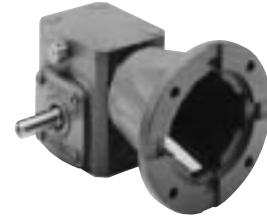

Figure 6.8

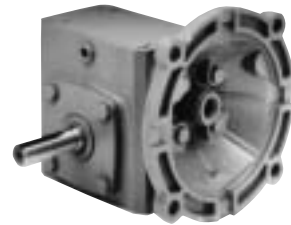

Figure 6.9

DOUBLE-REDUCTION, RFW-MODEL COUPLING AND FW-MODEL QUILL TYPES

Boston Gear's coupling-type (RFW model) and quill-type (FW model) double-reduction speed reducers are available in reduction ratios ranging from 100:1 to 3,600:1, and will accommodate motor inputs from 1/6 to 5 hp. The RFW model, with its self-positioning, two-piece steel coupling, has a straddle-mounted double-bearing support and is available with a standard NEMA C-face and coupling. The quill type is designed with a hollow input shaft suitable for assembly with NEMA C-face motors. (See Figure 6.10)



Figure 6.10

SINGLE-REDUCTION, BASIC TYPES

Boston Gear's basic single-reduction worm gear speed reducers serve all types of applications, and are available in reduction ratios ranging from 5:1 to 60:1 for motor inputs ranging from .07HP to 25HP. Multi-position mounting and a variety of shaft configurations allow installation in almost any position. Basic models feature positive-retained input shafts and bearing retainers; through-bore housings; and oversize roller and ball bearings. Options include: hollow output shafts; reaction rods; fan kits; riser blocks; vertical or horizontal bases; and double oil seals for input shafts. (See Figure 6.11)



Figure 6.11



Figure 6.12

DOUBLE-REDUCTION, BASIC TYPES

Boston Gear's basic double-reduction speed reducers are designed for efficiency and reliability. They are available in reduction ratios from 100:1 to 3,600:1, and will accommodate motor inputs from .07 HP to 5.75 HP. Basic models have positive-retained input shafts and bearing retainers. Precision through-bore housings assure true shaft positioning with proper mating of worms and gears. A broad range of input/output shaft configurations and multi-position mounting provide flexible reducer positioning.

(See Figure 6.12)

SPEED REDUCERS—COMMONLY USED TERMS

As we have learned throughout our Power Transmission 101 course, the world of gears – like so many other businesses and industries – has its own “language”. Let's look at some of the terms you need to know to become more familiar with the Boston Gear line of speed reducers.

Axial Movement: Endwise movement of input or output shaft, sometimes called endplay, usually expressed in thousandths of an inch.

Efficiency: The output power of the reducer (as compared to the input power). It is usually stated as a percentage.

Example:

- Input HP = 1 (75/100) (100) = 75% Efficiency
- Output HP = .75

BACKLASH

Rotational movement of the output shaft when holding the input shaft stationary and rotating the output shaft alternately clockwise and counterclockwise. Backlash may be expressed in thousandths of an inch measured at a specific radius at the output shaft.

CENTER DISTANCE

On a single reduction speed reducer, center distance is the distance between the center lines of the input and output shafts. Shaft center lines may be parallel or at right angles to one another. The center distance of multiple stage reducers usually refers to the lowest speed stage.

THRUST LOAD

The thrust load is the force imposed on a shaft parallel to the shaft axis. Thrust load is often encountered on shafts driving mixers, fans, blowers and similar pieces of equipment. When a thrust load acts on a speed reducer, the thrust load rating of the reducer must be high enough for the shafts and bearings to absorb the load.

MECHANICAL RATING

The mechanical rating is the maximum power or torque that a speed reducer can transmit, based on the strength and durability of its components. Obviously, the reducer may be rated no higher than the strength or durability of its weakest component. Reducers typically have a safety margin of two to three times their mechanical ratings. Thus, a reducer can withstand momentary overloads of 200-300% of its mechanical rating during a startup or other brief overload situation.

THERMAL RATING

The thermal rating is the maximum power or torque that a speed reducer can transmit continuously, based on its ability to dissipate heat generated by friction.

PRIME MOVER

The prime mover is the machine that provides power to a drive. The most frequently encountered prime movers include electric motors, internal combustion engines, hydraulic motors, and air motors. The type of prime mover used can affect the speed reducer during operation. For example, an electric motor runs relatively smoothly in comparison to an internal combustion engine.

MOUNTING POSITION

The relationship of the input and output shaft relative to the floor line is called the mounting position.

OUT-PUT RPM	RATIO	NON-FLANGED REDUCERS				SIZE
		GEAR CAPACITY			SIZE	
		OUTPUT TORQUE (LB.IN.)	HP			
		INPUT	OUT-PUT			
350	5:1	99	.60	.55	710-5	
		202	1.25	1.11	713-5	
		281	1.74	1.56	715-5	
		337	2.08	1.88	718-5	
		540	3.35	2.99	721-5	
		675	4.16	3.75	724-5	
		900	5.57	5.00	726-5	
175	10:1	123	.37	.34	710-10	
		243	.75	.67	713-10	
		343	1.07	.96	715-10	
		460	1.43	1.28	718-10	
		690	2.14	1.91	721-10	
		968	3.00	2.69	724-10	
		1181	3.63	3.27	726-10	

Figure 6.13

INPUT HORSEPOWER

The amount of power applied to the input shaft of a reducer by the prime mover is input horsepower. It is often used as a basis for selecting power transmission components. Input horsepower appears in the rating tables or drive manufacturers' published data. (See Figure 6.13)

(Important: Input horsepower ratings represent the maximum amount of power that the reducer can handle safely.)

OUTPUT HORSEPOWER

The amount of power available at the output shaft of a reducer is the output horsepower. Due to losses caused by inefficiency, output horsepower is always less than input horsepower. (See Figure 6.13)

OVERHUNG LOAD

A force applied at right angles to the shaft, beyond its outermost bearing is the overhung load. Both the input and output shaft of a speed reducer can be subject to an overhung load. Such a force is a shaft bending under load resulting from a gear, pulley, sprocket or other external drive member. Besides the tendency to bend the shaft, the overhung load (the radial force on the shaft) is reacted to by the shaft in its bearings. Therefore, the overhung load creates loads that the bearings must be able to support without damage.

SERVICE FACTORS

A numbering system that identifies the loads that must be considered in selecting a speed reducer is the service factor. Service factors vary according to the type of service for which the reducer is to be used, the kind of prime mover involved and the duty cycle. The service factor can be a multiplier applied to the known load, which redefines the load in accordance with the conditions at which the drive will be used, or it can be a divisor applied to catalog reducer ratings, thus redefining the rating in accordance with drive conditions.

The service factor is usually applied to the speed reducer, but can also be applied to the nameplate rating of the prime mover.

REDUCTOR

Boston Gear's registered trademark for a speed reducer having a projecting input shaft suitable for mounting a coupling, sprocket, pulley or gear is a reductor.

(See Figure 6.14)

RATIOMOTOR™

Boston Gear's registered trademark for a motorized reducer consisting of a flanged reductor and face mounted motor assembly. A Ratiomotor is sometimes referred to as a gearmotor.

SELF LOCKING ABILITY

Boston 700 Series reducers, under no conditions should be considered to hold a load when at rest.

BACK-DRIVING

Is the converse of self-locking, depending upon reduction ratio and many other variables, it is difficult to predict the back-driving capability of a 700 Series reducer. Worm gear reducers are not intended to be used as speed increasers. Please consult the factory for back-driving applications.

SELECTING THE RIGHT SPEED REDUCER

In order to select the "right" motorized or non-motorized speed reducer for a given application, it is necessary to use the selection charts that are in your Worm Gear Drives catalog. You will find that the charts are similar to those we used in previous lessons on open gearing.

As is the case when selecting all power transmission equipment, you must know the following when selecting a speed reducer:

- Horsepower
- Torque
- Speed – RPM
- Service Factor



Figure 6.14



Figure 6.15

Note: When space or design will permit, selecting the use of an auxiliary drive between the speed reducer and the machine to be driven provides the following advantages:

- Cost savings on the complete drive
- A wider range of speed reduction
- Use of a smaller speed reducer
- Possible use of a smaller HP motor

These advantages occur because the use of an auxiliary drive between the speed reducer and the driven machine reduces the torque required at the output shaft of the speed reducer in direct proportion to the auxiliary drive ratio. More economical solutions will usually be provided by higher auxiliary drive reduction ratios, which normally should not exceed a 6:1 ratio.

Now let's begin our step-by-step selection process:

Step 1 – To determine the best auxiliary drive ratio to use, first multiply the maximum machine speed by six.

Step 2 – From the reducer selection charts listed in the Boston Gear 700 Series catalog, select the *next lower maximum operating speed* listed.

Step 3 – Divide the maximum operating speed by the maximum machine speed to obtain the proper auxiliary drive ratio.

Steps 4 – To calculate the torque of the speed reducer to be selected, divide the machine torque by the auxiliary drive ratio* you found above in Step 3.

(*Remember: Efficiency should also be included in output torque calculations. Use the following formula: Output torque = input torque x ratio x efficiency.)

Step 5 – Select the chain pitch and sprocket or spur gears. (See Figure 6.15)

Example:

- Output torque of speed reducer: 500 in lbs.
- Ratio of chain drive 3:1

- Approximate efficiency of chain drive: 95%

$OPT = 500 \times 3 \times 95\% = 1425$ inch pounds

ORDERING THE 700 SERIES

Keep the following information in mind when ordering a 700 Series speed reducer from Boston Gear.

- Reducers may be mounted in several positions relative to the floor line, with single or double output shafts. They also may be furnished motorized and non-motorized.

**700 SERIES REDUCERS:
MAXIMUM ALLOWABLE INPUT SPEEDS**

The maximum input speed (RPM) listed is for intermittent duty – 15-20 minutes running time – at maximum calculated output torque.

<i>Single Reduction</i>		<i>"W" Double Reduction</i>	
Size	Max. Input RPM	Size	Max. Input RPM
713	3600	713	3600
715	3600	718	3600
718	3600	721	3600
721	3600	726	3600
724	3600	732	3600
726	3600	738	3600
732	3600	752	3600
738	3200	760	3200
752	2500		
760	1750		

To calculate the allowable output torque rating of a reductor when input speed (RPM) is above 1750 RPM:

Step 1 – Calculate the output RPM of the reductor.

- Reductor output RPM = Input RPM ÷ Ratio

Step 2 – Determine the output torque.

Output Torque = 63025 x Output horsepower (HP) listed in the catalog for 1750 RPM ÷ Reductor output (RPM)

Example: Using the 700 Series catalog, calculate the maximum output torque rating of a 725-30 reductor, with an input speed at 3600 RPM.

Step 1: Reductor output RPM = Input RPM ÷ Ratio = 120

Step 2: Reductor output torque = 63025 x .91 ÷ 120 = 478 inch pounds

(**Note:** Noise level may increase when operating above 1750 RPM input.)

LUBRICATION

Boston Gear's synthetic lubrication recommendations – as well as AGMA recommendations – are shown below. Please keep in mind that *700 Series speed reducers are shipped without lubricant*. Prelubricated 700 Series reducers are available as a special option – and must be ordered as such. (See Chart 6.16)

ENCLOSED WORM GEAR REDUCERS

Ambient (Room) Temperature	Recommended Oil (Or Equivalent)	Viscosity Range SUS @100°F	Lubricant AGMA No.	ISO Viscosity Grade No. †
-30° to 225°F‡ (-34°C to 107°C)	Mobil SHC 634* Synthetic	1950/2150	—	320/460
40° to 90°F (4.4°C to 32.2°C)	Mobil 600W Cylinder Oil	1920/3200	7 or 7C	460
80° to 125°F (26.7°C to 51.7°C)	Mobil Extra Hecla Super Cylinder Oil	2850/3600	8 or 8C	680

Chart 6.16

AXIAL MOVEMENT – Endwise movement of input or output shafts, sometimes called endplay, is usually expressed in thousands of an inch.

EFFICIENCY – The amount of output power of the reducer as compared to the amount of input power. It is usually stated as a percentage.

Example:

$$\begin{aligned} \text{Input HP} &= 1 \\ \text{Output HP} &= .75 \end{aligned} \quad (75/100) \times (100) = 75\% \text{ Efficiency}$$

BACKLASH – Rotational movement of the output shaft when holding the input shaft stationary and rotating the output shaft alternately clockwise and counter clockwise. Backlash may be expressed in thousands of an inch measured at a specific radius at the output shaft.

CENTER DISTANCE – On a single reduction reducer, this is the distance between the center lines of the input and output shafts. Shaft center lines may be parallel or at right angles to one another. The center distance of multiple stage reducers usually refers to the lowest speed stage (last reduction).

THRUST LOAD – Forces imposed on a shaft parallel to the shaft axis. Such a force is called a thrust load. It is often encountered on shafts driving mixers, fans, blowers and similar machines. When a thrust load acts on a speed reducer, you must be sure that the thrust load rating of the reducer is high enough that it's shafts and bearings can absorb the load.

MECHANICAL RATING – The maximum power or torque that a speed reducer can transmit, based on the strength and durability of its components, is its mechanical rating. Obviously, the reducer may be rated no higher than the strength or durability of its weakest component. Reducers typically have a safety margin of two to three on their mechanical ratings. Thus, a reducer can withstand momentary overloads of 200-300% of its mechanical rating during a startup or other brief overload situations.

THERMAL RATING – The maximum power or torque that a speed reducer can transmit continuously, based on its ability to dissipate heat generated by friction, is called its thermal rating.

PRIME MOVER – The machine that provides power to a drive is its prime mover. The most frequently encountered prime movers include electric motors, internal combustion engines, hydraulic motors and air motors. The type of prime mover used can affect the speed reducer during operation. For example, an electric motor runs relatively smoothly in comparison to an internal combustion engine.

MOUNTING POSITION – The relationship of the input and output shafts relative to the floor line.

INPUT HORSEPOWER – The amount of power applied to the input shaft of a reducer by the prime mover is its input horsepower. It is often used as a selection basis for power transmission components, and it appears in the rating tables of drive manufacturer's published data. Remember that input horsepower ratings represent the maximum amount of power that the reducer can safely handle.

OUTPUT HORSEPOWER – The amount of power available at the output shaft of a reducer is its output horsepower. Due to losses caused by inefficiency, output horsepower is always less than input horsepower.

OVERHUNG LOAD – The input or the output shaft of a speed reducer can be subject to an overhung load; that is, to a force applied at right angles to the shaft, beyond its outermost bearing. Such a force is a shaft bending load resulting from a gear, pulley, sprocket or other external drive member. Besides the tendency to bend the shaft, the overhung load (that is, the radial force on the shaft) is reacted to by the shaft in its bearings. Therefore, the overhung load creates loads that the bearings must be able to support without damage.

SERVICE FACTORS – Numbers which modify the loads which must be considered in selecting a speed reducer are called service factors. They vary with the type of service in which the reducer is to be used, the kind of prime mover involved and the duty cycle. The service factor can be a multiplier applied to the known load, which redefines the load in accordance with the conditions at which the drive will be used, or it can be a divisor applied to catalog reducer ratings, thus redefining the rating in accordance with drive conditions. The service factor is usually applied to the speed reducer, but can also be applied to the name plate rating of the prime mover.

REDUCTOR® – Boston Gear's registered trademark for a speed reducer having a projecting input shaft suitable for mounting a coupling, sprocket, pulley or gear.

FLANGED REDUCTOR – Boston Gear's name for a reductor furnished with an input flange suitable for attaching a face mounted motor.

RATIOMOTOR® – Boston Gear's registered trademark for a motorized reducer consisting of a flanged reductor and face mounted motor assembled, sometimes referred to as a gearmotor.

SELF-LOCKING ABILITY – Boston 700 Series reducers, under no conditions should be considered to hold a load when at rest.

BACK-DRIVING – This is the converse of self-locking. Depending upon ratio and many variables, it is difficult to predict the back-driving capability of a 700 Series reducer. Worm gear reducers are not intended to be used as speed increasers. Consult factory for back-driving applications.

Keypoints

- Boston Gear has right angle speed reducers in ratios from 5:1 to 3600:1
- Boston Gear has 4 different styles in 11 basic sizes. In 1" to 6" center distance
- 700 Series are made for industrial applications
- Boston Gear also carries a complete family of washdown speed reducers in both white epoxy coated stainless steel coated
- Boston Gear was the first to manufacture a multiply mounting right angle worm gear speed reducer

Quiz

CLICK HERE or visit <http://www.bostgear.com/quiz> to take the quiz

800 SERIES HELICAL GEAR DRIVES



Boston Gear introduced the 800 Series in July of 2000. The 800 Series is a direct drop in for the SEW Eurodrive in line helical gearmotors. Listed below are many of the 800 Series standard features.

FEATURES

- Dimensionally interchangeable with SEW Eurodrive® and other U.S. and European suppliers
- Standard NEMA C-face design will accept any standard NEMA motor
- Ratio's up to 70:1 in only two stages increases efficiency and reduces case size
- Accessible oil seals for routine product maintenance
- All units can be double sealed on the input for severe applications
- Prefilled with synthetic lubrication for your specific mounting position (sizes 3 and 4 lubricated for life)
- Washdown duty units in white or stainless steel epoxy coatings

The 800 Series carries the following specifications:

SPECIFICATIONS

- Four in-line helical sizes
- Fractional through 10 horsepower flanged, fractional through 20 horsepower non-flanged
- Output torque ratings up to 5400 inch pounds
- Foot mount and output flange mounted models
- Ratios from 1:5:1 to 250:1
- Standard NEMA C-face and non-flanged models

800 SERIES IN-LINE HELICAL GEAR DRIVES

You will find the Boston Gear 800 Series is easy to select, easy to apply and easy to obtain. The Boston Gear 800 Series contains a focused selection of compact, heavy-duty helical gear drives, with long life performance features and simplified maintenance. Models include double and triple reduction units in flanged or foot mounted arrangements. You can choose from a wide range of reduction ratios to suit specific applications and a variety of input shaft configurations for maximum positioning flexibility. All units are adaptable to floor, sidewall or ceiling mounting.

The 800 Series has two available USDA approved finishes

- Durable non-absorbent, non-toxic white (BK) or stainless epoxy finish (SBK)
- Washable & Scrubbable
- Includes all the standard 800 Series features

THE INSIDE STORY

The key to the success of the popularity of the Boston Gear 800 Series is the following:

- Available in both standard NEMA C-Face flanged and direct input non-flanged configurations. NEMA C-Face units allow for direct assembly of the reducer and any industry standard motor.
- All units shipped prelubricated for standard mounting or for your particular mounting position.
- A wide range of available gear reduction ratios, from 1.5:1 to 250:1, allows the 800 Series to fulfill a broad range of output speed requirements.
- High strength steel output shaft assures capacity for high torque and overhung loads.
- Rugged housing of fine grained, gear quality cast iron provides maximum strength and durability.
- High grade nickel chromium molybdenum steel allows for superior heat treating of gears resulting in a highly efficient (95 to 98%) and quiet gear drive.

(See Figure 7.1)

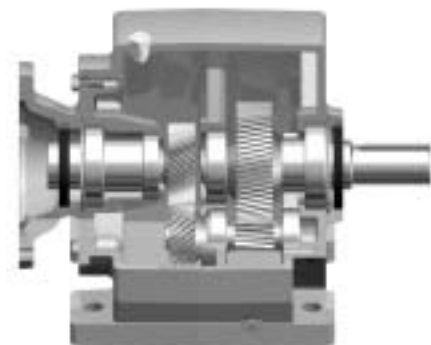

Figure 7.1



Figure 7.2, Foot Mounted NEMA C-face F800



Figure 7.3, Foot Mounted 800



Figure 7.4, Output Flange Mounted NEMA C-Face F800F



Figure 7.5, Output Flange Mounted 800F

- Dimensionally interchangeable with major European manufacturers.
- Oversized ball bearings and reduced straddle distance between bearings enhance the unit's durability, reliability and capability of supporting high overhung loads.
- Oil seal location provides easy, immediate access for routine product maintenance. Additionally, all sizes can be double sealed on the high shafts for severe applications.
- Ratios up to 70:1 in only two stages increases efficiency and reduces case size.
(See Figures 7.2 - 7.5)

INTERCHANGE GUIDE

You will find a convenient interchange guide in the Boston Gear 800 Series in-line helical catalog. This allows you to interchange from different manufacturers to the Boston Gear 800 Series.

Boston Gear 800 Series In-Line Helical Gear Drives are designed to be functionally interchangeable with these and many other manufacturer's drives. This chart is intended to be a guide only. Please see appropriate manufacturer's catalogs for exact details regarding ratings and dimensions.

Interchange Guide

Manufacturers	Size	Foot Mounted NEMA C-Face F800	Foot Mounted 800	Output Flange Mounted NEMA C-Face F800F	Output Flange Mounted 800F
Boston	830	F832/F833	832/833	F832F/F833F	832F/833F
SEW Eurodrive	32	R32LP	Not Available	RF32LP	Not Available
Flender	E20*	E20 (M, G, OR A)*	E20A*	EF20 (M, G OR A)*	EF20A*
Dodge	1	SM1A/DM1A/TM1A	SR1A/DR1A/TR1A	SM1F/DM1F/TM1F	SR1F/DR1F/TR1F
Sumitomo	3090	H (C or M) 3090/95/97	H3090/95/97	HF(C or M) 3090/95/97	HF3090/95/97
Stober	C002	C002N-MR	C002N-AW	C002F-MR	C002F-AW
Boston	840	F842/F843	842/843	F842F/F843F	842F/843F
SEW Eurodrive	40	R40LP	R40	RF40LP	RF40
Flender	30	E30/Z30/D30-(M, G, or A)	E30/Z30/D30	EF30/ZF30/DF30 (M, G or A)	EF30/ZF30/DF30
Dodge	2	SM2A/DM2A/TM2A	SR2A/DR2A/TR2A	SM2F/DM2F/TM2F	SR2F/DR2F/TR2F
Sumitomo	3100	H(C or M) 3100/05	H3100/05	HF(C or M) 3100/05	HF3100/05
Stober	C100	C102/3N-MR	C102/3N-AW	C102/3F-MR	C102/3F-AW
Boston	860	F862/F863	862/863	F862F/F863F	862F/863F
SEW Eurodrive	60	R60LP/R63LP	R60/R63	RF60LP/RF63LP	RF60/RF63
Flender	40	E40/Z40/D40-(M, G or A)	E40/Z40/D40	EF40/ZF40/DF40-(M, G or A)	EF40/ZF40/DF40
Dodge	3	SM3A/DM3A/TM3A	SR3A/DR3A/TR3A	SM3F/DM3F/TM3F	SR3F/DR3F/TR3F
Sumitomo	3110	H(C or M) 3110/15	H3110/15	HF(C or M) 3110/15	HF3110/15
Stober	C200	C202/3N-MR	C202/3N-AW	C202/3F-MR	C202/3F-AW
Boston	870	F872/F873	872/873	F872F/F873F	872F/873F
SEW Eurodrive	70	R70LP/R73LP	R70/R73	RF70LP/RF73LP	RF70/RF73
Flender	60	E60/Z60/D60 - (M,D or A)	E60/Z60/D60	EF60/ZF60/DF60 (M, D or A)	EF60/ZF60/DF60
Dodge	4	SM4A/DM4A/TM4A	SR4A/DR4A/TR4A	SM4F/DM4F/TM4F	SR4F/DR4F/TR4F
Sumitomo	3140	H(C or M) 3140/45	H3140/45	HF(C or M) 3140/45	HF3140/45
Stober	C400	C402/3N-MR	C402/3N-AW	C402/3F-MR	C402/3F-AW

* Single reduction models only.

NUMBERING SYSTEM / HOW TO ORDER

NUMBERING SYSTEM

The Boston Gear numbering system is standard for all Boston Gear Reducers. The 800, 700, 600 and 200 Series share common letter prefixes. It is simple to select any Boston Gear speed reducer by following this easy system.

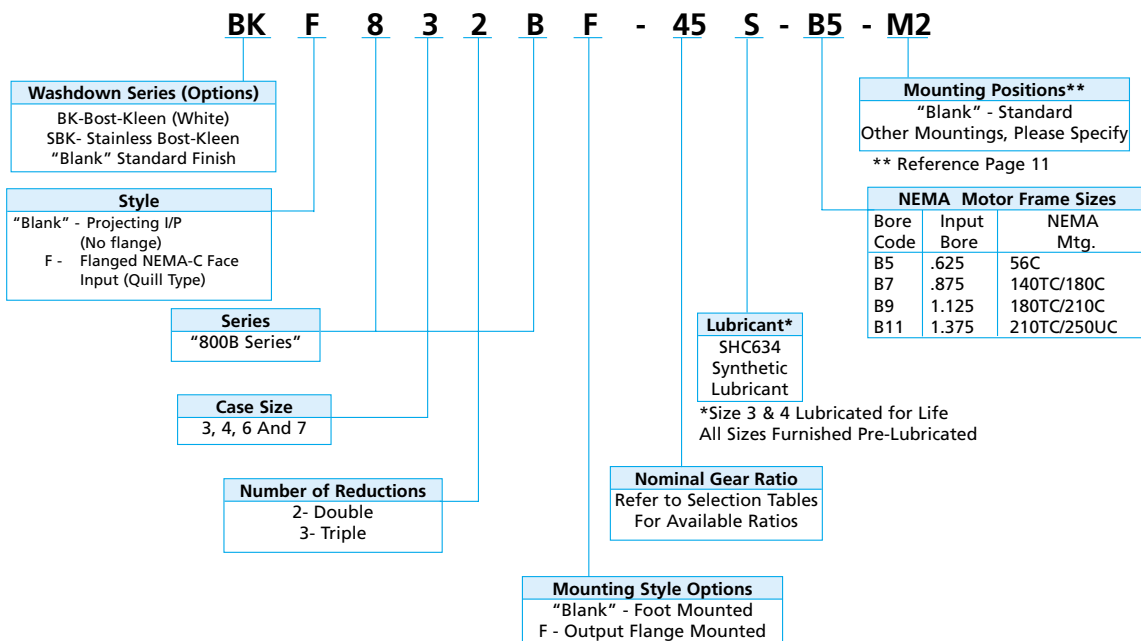

HOW TO ORDER

EXAMPLE:

Required flange input NEMA 56C, and flanged output, 1/3 HP, Class I, 45:1 ratio, lubricated, and standard mounting position.

ORDER:

1 pc F832BF-45S-B5

OVERHUNG LOAD

If the output shaft of a gear drive is connected to the driven machine by means other than a flexible coupling, an overhung load is imposed on the shaft. This load may be calculated as follows:

$$OHL = \frac{2TK}{D}$$

- OHL = Overhung Load (LB.)
- T = Shaft Torque (LB.-IN.)
- D = Pitch Diameter of Sprocket, Pinion or Pulley (IN.)
- K = Load Connection Factor

LOAD CONNECTION FACTOR (K)

- Sprocket or Timing Belt 1.00
- Pinion and Gear Drive. 1.25
- Pulley and V-Belt Drive 1.50
- Pulley and Flat Belt Drive 2.50

Overhung load is a necessary consideration in sizing any speed reducer. Too much torque or weight connected to the output shaft can crack or bend. The formula above can help determine the overhung load. After using the formula to find the overhung load, compare the results to the chart below (Table 2).

An overhung load greater than permissible load value may be reduced to an acceptable value by the use of a sprocket, pinion or pulley of a larger PD. Relocation of the load closer to the center of gear drive will also increase OHL capacity.

Table 2

OVERHUNG LOADS (LBS) & AXIAL THRUST (LBS) CAPACITIES ON OUTPUT SHAFT

OUTPUT RPM	832 / 833 OHL	842 / 843 OHL	862 / 863 OHL	872 / 873 OHL
1000	270	425	715	950
500	300	455	805	1065
350	340	465	830	1065
250	360	485	880	1065
200	385	505	900	1065
150	385	525	945	1090
100	385	620	1010	1275
50	385	770	1360	1720
25 & under	385	770	1600	2090
THRUST	390	635	1200	1580

Overhung loads are calculated at the center of the shaft extension and with no thrust load. For combined loading consult factory.

OVERHUNG LOADS (LBS) ON INPUT SHAFT AT 1750 RPM

SIZE	832	833	842	843	862	863	872	873
OHL	344	390	314	373	310	315	402	371

Overhung loads are calculated at the center of the shaft extension and with no thrust load.

LUBRICANT AND QUANTITY

Improper lubrication or the lack thereof, can result in shortening the life of a reducer. Many times the reducer will totally fail as a result of neglect.

Synthetic SHC634 is recommended for the 800 Series gear drives and, at all times, the lubricant must remain free from contamination. Normal operating temperatures range between 150°F - 170°F. During the initial break-in of the gear drive, higher than normal operating temperatures may result. All gear drives are supplied filled with SHC634 synthetic oil and with the quantity listed below for standard mounting position M1 or M8 or to mounting specified at time of order. (See Figure 7.6 A-D)

- Sizes 832/833 and 842/843 are lubricated for life, for universal mounting. No vent required.
- Sizes 862/863 and 872/873 will require an oil change after 20,000 hours of operation. More frequent changes may be required when operating in high temperature ranges or unusually contaminated environments.
- Satisfactory performance may be obtained in some applications with non-synthetic oils and will require more frequent changes.

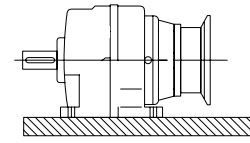

Figure 7.6A, M1

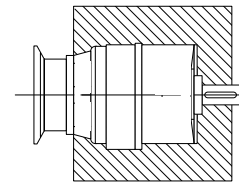

Figure 7.6B, M2

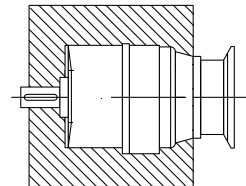

Figure 7.6C, M3

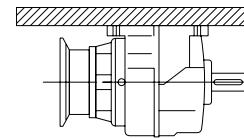

Figure 7.6D, M4

Recommended Lubricant	Ambient Temperature	ISO Viscosity Grade No.	Boston Gear Item Code	
			Quart	Gallon
Mobil SHC634	-30° to 225°F	320 / 460	51493	51494
Mobile D.T.E Oil Extra Heavy	50° to 125°F	710 / 790	N/A	N/A

OIL CAPACITIES (QUARTS)

UNIT SIZE	MOUNTING POSITIONS								
	M1	M2	M3	M4	M5	M6	M7	M8	M9
	Foot Mounted						Output Flange Mounted		
832	.63	.63	.84	.84	.84	1.1	.63	.84	1.1
833	.84	.84	1.1	1.1	1.8	1.6	.84	1.8	1.6
842	.63	.63	1.2	1.2	1.5	1.7	.63	1.5	1.7
843	.95	.95	1.4	1.4	2.2	2.2	.95	2.4	2.2
862	1.3	1.3	2.3	2.3	3.0	3.4	1.3	3.0	3.4
863	1.9	1.9	2.7	2.7	5.0	5.0	1.9	5.0	5.0
872	2.6	2.6	4.8	4.8	6.3	7.1	2.6	6.3	7.1
873	3.0	3.8	5.9	5.9	9.5	9.5	3.0	10.8	9.5

IN-LINE HELICAL SELECTION TABLES

Beginning on page 30 of the Boston Gear 800 Series catalog are the unit's ratings. Below is an example of how to use the rating tables. First find the correct heading for "Non-flanged" or "Flanged" (gearmotors). As in the example below, select the flanged (gearmotor) 2HP reducer. This reducer carries 3268 LB ins. torque. Continuing to the right, the model #F872B-505-B7 is selected.

Approx. Output RPM	Ratio *	Non-Flanged				Flanged (Gearmotors)				
		Gear Capacity		Non-Flange O/P	Output Flange	Ratings			Non-Flange O/P	Output Flange
		Output Torque (LB-IN.)	Input HP	Catalog No. (Item Code)	Catalog No. (Item Code)	Motor HP	Output Torque (LB-IN.)	S.C. **	Catalog No. (Item Code)	Catalog No. (Item Code)
35	50	5216	3.16	872B-505 (16886)	872BF-505 (19813)	3	4900	I	F872B-505-B9 (80863)	F872BF-505-B9 (33806)
						2	3268	II	F872B-505-B7 (26494)	F872BF-505-B7 (33804)
						1.5	2552	III		
		5290	3.02	873B-505 (16918)	873BF-505 (19937)	3	5256	I	F873B-505-B9 (30868)	F873BF-505-B9 (27312)
						2	3504	II	F873B-505-B7 (30866)	F873BF-505-B7 (27294)
						1.5	2628	II		

* Gear Ratio is Approximate. For Actual Gear Ratio Reference Pages 30-39. in the 800 Series Catalog

** Service Class I (S.F. = 1.00) Service Class II (S.F. = 1.50) Service Class III (S.F. = 2.00)

Overhung Load Ratings refer to Page 9 in the 800 Series Catalog.

Indicates Triple Reduction

NON-FLANGED

Example of rating table found in the Boston Gear 800 Series Catalog.

Catalog Number	Input Speed								
	1750 RPM			1450 RPM			1160 RPM		
	Approx. Output RPM	Output Torque (LB-IN)(Max.)	Inut HP (Max.)	Approx. Output RPM	Output Torque (LB-IN)(Max.)	Input HP (Max.)	Approx. Output RPM	Output Torque (LB-IN) (Max.)	Input HP (Max.)
832B/BF1.5S	1170	288	5.80	970	293	4.82	773	293	3.85
842B/BF1.5S	1170	479	9.08	970	509	8.00	773	549	6.89
862B/BF1.5S	1170	830	16.20	970	884	14.30	773	950	12.30
872B/BF1.5S	1170	1094	21.20	970	1090	17.50	773	1090	14.00
832B/BF1.9S	922	325	4.77	763	325	3.95	610	325	3.16
842B/BF1.9S	922	643	8.69	763	685	7.66	610	738	6.60
862B/BF1.9S	922	1100	15.40	763	1189	13.60	610	1278	11.70
872B/BF1.9S	922	1492	21.20	763	1485	17.50	610	1484	14.00
832B/BF2.3S	760	333	4.29	630	339	3.56	504	339	2.84
842B/BF2.3S	760	695	8.52	630	739	7.51	504	788	6.40
862B/BF2.3S	760	1217	15.00	630	1292	13.20	504	1396	11.40
872B/BF2.3S	760	1680	21.20	630	1680	17.50	504	1680	14.00
832B/BF2.6S	673	350	3.98	560	350	3.30	446	350	2.64
842B/BF2.6S	673	715	7.95	560	762	7.01	446	777	5.72
862B/BF2.6S	673	1320	14.50	560	1408	12.80	446	1498	10.90
872B/BF2.6S	673	1800	21.20	560	1796	17.50	446	1796	14.00
832B/BF2.9S	605	533	5.18	500	544	4.38	400	559	3.60
842B/BF2.9S	605	840	8.34	500	872	7.35	400	939	6.33
862B/BF2.9S	605	1560	15.90	500	1660	14.00	400	1790	12.10
872B/BF2.9S	605	2135	21.20	500	2130	17.50	400	2130	14.00
832B/BF3.3S	530	370	3.24	440	370	2.69	350	370	2.15
842B/BF3.3S	530	775	7.03	440	775	5.83	350	775	4.66
862B/BF3.3S	530	1550	13.40	440	1648	11.80	350	1720	9.85
872B/BF3.3S	530	2398	21.20	440	2390	17.50	350	2390	14.00
832B/BF3.5S	500	376	3.11	414	376	2.57	331	376	2.06
842B/BF3.5S	500	858	6.46	414	832	5.35	331	832	4.28
862B/BF3.5S	500	1665	12.70	414	1751	11.10	331	1814	9.16
872B/BF3.5S	500	2704	21.00	414	2720	17.50	331	2720	14.00
832B/BF3.9S	448	552	3.97	372	563	3.36	297	576	2.75
842B/BF3.9S	448	959	6.96	372	1020	6.13	297	1100	5.28
862B/BF3.9S	448	1835	13.30	372	1950	11.70	297	2110	10.10
872B/BF3.9S	448	2902	21.20	372	2892	17.50	297	2892	14.00
832B/BF4.4S	400	572	3.54	330	585	3.00	264	588	2.41
842B/BF4.4S	400	1000	6.59	330	1066	5.81	264	1146	5.00
862B/BF4.4S	400	1933	12.50	330	2050	11.00	264	2215	9.49
872B/BF4.4S	400	3265	21.20	330	3254	17.50	264	3254	14.00
832B/BF5.1S	340	592	3.31	285	592	2.74	227	592	2.19
842B/BF5.1S	340	1065	5.96	285	1135	5.26	227	1232	4.53
862B/BF5.1S	340	2042	11.60	285	2167	10.20	227	2330	8.78
872B/BF5.1S	340	3698	21.20	285	3685	17.50	227	3685	14.00

* For applications requiring a service factor greater than 1.0, multiply the design torque or horsepower by the application factor, found on pages 58 & 59.
 Actual Output RPM = Input Speed ÷ Actual Ratio.
 For Overhung Load Ratings refer to Page 9 in the 800 Series Catalog.



FOOT MOUNTED

This is a typical page of dimensional information found in the 800 Series catalog. Example: If the OAH 07A F842 were desired, simply find the "K" dimension for a F842 follow over to the K dimension and find 6.99".

SIZE	A	B	C	D	E	G	H	K	L	N	O	P	Q	T
F832	5.44	4.33	4.33	3.35	1.05	.48	2.95	5.79	2.28	3.16	2.84	1/4	.63	.39
F842	5.71	6.30	4.33	5.12	1.48	.67	3.54	6.99	2.95	3.31	2.95	1/4	.63	.39
F862	7.48	7.87	5.31	6.50	2.19	.81	4.53	9.06	3.54	4.13	3.87	3/8	.87	.59
F872	9.06	9.65	6.69	8.07	2.64	1.03	5.51	10.83	4.53	5.12	4.69	5/8	1.38	.75

Table A

SIZE	LOW SPEED SHAFT				M				R			
	U +.000 -.001	V	W-Key		NEMA MOUNTING				NEMA MOUNTING			
			Sq.	Lgth.	56C	140TC	180TC	210TC	56C	140TC	180TC	210TC
					B5	B7	B9	B11	B5	B7	B9	B11
F832	.750	1.57	.19	1.28	9.82	9.82	10.65	----	3.31	3.31	4.63	----
F842	1.000	1.97	.25	1.75	10.73	10.73	11.55	----	3.31	3.31	4.63	----
F862	1.250	2.36	.25	2.00	12.26	12.26	14.61	14.61	3.31	3.31	4.63	4.63
F872	1.625	3.15	.38	2.37	15.15	15.15	16.76	16.76	3.31	3.31	4.63	4.63

Output shaft rotation, relative to input shaft rotation, is identical for double reduction and opposite for triple reduction.

Table B

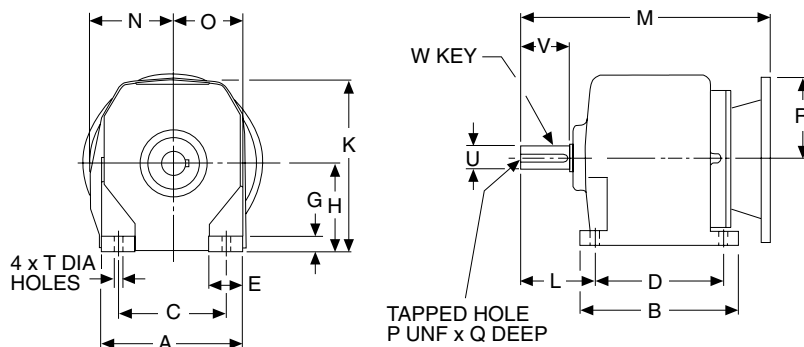

AGMA SERVICE FACTORS AND LOAD CLASSIFICATIONS

Also found in the Boston Gear 800 Series catalog, are AGMA (American Gear Manufacturer Association) Service Factor tables. Find the application that is closest to what is needed and apply that service factor to the required HP, to determine the design horsepower.

SERVICE FACTOR CHART

AGMA CLASS OF SERVICE	SERVICE FACTOR	OPERATING CONDITIONS
I	1.00	Moderate Shock - not more than 15 minutes in 2 hours. Uniform Load - not more than 10 hours per day.
II	1.25	Moderate Shock - not more than 10 hours per day. Uniform Load - more than 10 hours per day.
	1.50	Heavy Shock - not more than 15 minutes in 2 hours. Moderate Shock - more than 10 hours per day.
III	1.75	Heavy Shock - not more than 10 hours per day.
	2.00	Heavy Shock - more than 10 hours per day.

TYPE OF MACHINE TO BE DRIVEN	NON-MOTOR REDUCER (SERVICE FACTORS)		MOTORIZED REDUCER (CLASS OF SERVICE)	
	HRS. PER DAY		HRS. PER DAY	
	3 TO 10	OVER 10	3 TO 10	OVER 10
PAPER MILLS (Continued)				
Chipper	—	2.00	—	III
Chip Feeder	1.25	1.50	—	—
Coating Rolls - Couch Rolls	1.00	1.25	—	—
Conveyors - Chips - Bark Chemical	1.00	1.25	—	—
Conveyors - Log and Slab	—	2.00	—	—
Cutter	—	2.00	—	—
Cylinder Molds, Dryers - Anti-Friction	—	1.25	—	—
Felt Stretcher	1.25	1.50	—	II
Screens - Chip and Rotary	1.25	1.50	—	—
Thickener (AC)	1.25	1.50	—	—
Washer (AC)	1.25	1.50	—	—
Winder - Surface Type	—	1.25	—	II
PLASTICS INDUSTRY				
Intensive Internal Mixers				
Batch Type	—	1.75	—	—
Continuous Type	—	1.50	—	—
Batch Drop Mill - 2 Rolls	—	1.25	—	—
Compounding Mills	—	1.25	—	—
Calendars	—	1.50	—	—
Extruder - Variable Speed	—	1.50	—	—
Extruder - Fixed Speed	—	1.75	—	—
PULLERS				
Barge Haul	—	2.00	—	—
PUMPS				
Centrifugal	—	1.25	—	—
Proportioning	—	1.50	*	*
Reciprocating				
Single Acting, 3 or More Cycles	1.25	1.50	II	III
Double Acting, 2 or More Cycles	1.25	1.50	II	III
Rotary - Gear or Lube	1.00	1.25	I	II
RUBBER INDUSTRY				
Batch Mixers	—	1.75	—	—
Continuous Mixers	—	1.50	—	—
Calendars	—	1.50	—	—

TYPE OF MACHINE TO BE DRIVEN	NON-MOTOR REDUCER (SERVICE FACTORS)		MOTORIZED REDUCER (CLASS OF SERVICE)	
	HRS. PER DAY		HRS. PER DAY	
	3 TO 10	OVER 10	3 TO 10	OVER 10
RUBBER INDUSTRY (Con't.)				
Extruders - Continuous	—	1.50	—	—
Extruders - Intermittent	—	1.75	—	—
Tire Building Machines	—	—	II	II
Tire and Tube Press Openers	—	—	I	I
SEWAGE DISPOSAL EQUIPMENT				
Bar Screens	1.00	1.25	I	II
Chemical Feeders	1.00	1.25	I	II
Collectors	1.00	1.25	I	II
Dewatering Screws	1.25	1.50	II	II
Scum Breakers	1.25	1.50	II	II
Slow or Rapid Mixers	1.25	1.50	II	II
Thickeners	1.25	1.50	II	II
Vacuum Filters	1.25	1.50	II	II
SCREENS				
Air Washing	1.00	1.25	I	II
Rotary - Stone or Gravel	1.25	1.50	II	II
Traveling Water Intake	1.00	1.25	I	II
Skip Hoists	—	—	II	—
Slab Pushers	1.25	1.50	—	—
Stokers	—	1.25	—	II
TEXTILE INDUSTRY				
Batchers or Calendars	1.25	1.50	II	II
Cards	1.25	1.50	I	II
Card Machines	1.75	2.00	III	III
Dry Cans and Dryers	1.25	1.50	II	II
Dyeing Machines	1.25	1.50	II	II
Looms	1.25	1.50	*	*
Mangles, Nappers and Pads	1.25	1.50	II	II
Soapers, Tenner Frames	1.25	1.50	II	II
Spinners, Washers, Winders	1.25	1.50	II	II
Tumbling Barrels	1.75	2.00	III	III
Windlass	1.25	1.50	II	III

*Consult Manufacturer.

This list is not all-inclusive and each application should be checked to determine if any unusual operating conditions will be encountered.

Quiz

CLICK HERE or visit <http://www.bostgear.com/quiz> to take the quiz

INTRODUCTION TO RATIOCONTROL



Modern industrial processes require operating speeds that maximize production, profit and quality. Today, these speeds can be achieved through mechanical power, fluid power or electrical power. In this section of our Power Transmission 101 course, we will focus on electrical speed drive products and *Ratiocontrol* – Boston Gear's trade name for several types of adjustable speed drives.

DEVELOPMENT OF DC TECHNOLOGY

Historically, AC to DC conversion progressed from electromechanical devices, such as the motor-generator set, to vacuum tube controllers and variable transformer/rectifier systems. With the development of the silicon controlled rectifier (SCR) in the early 1960s, a new generation of controllers was developed which, in simple terms:

- Permitted the use of a low voltage "trigger" circuit to control the rectification of AC power, and
- Adjusted the voltage level of the DC output.

Armature voltage feedback and current (load) monitoring circuits provided the means to correct speed changes resulting from load and achieve the best possible relationship between speed signal and actual motor speed.

Later advances in SCR design and associated circuitry led to their use in controlling larger horsepower motors. Optional features, such as adjustable torque, dynamic braking, operator's control stations, master override, multiple set speeds and follower circuits for a variety of signals became commonplace in industrial adjustable speed applications.

With the above background in mind, let's learn more about AC and DC motors.

AC AND DC MOTORS

ALTERNATING CURRENT (AC) MOTORS

All of the electric power in North America is 60-cycle alternating current (AC), meaning that the line voltage and current go through 60 complete cycles per second. The number of cycles per second is referred to as the "line frequency," an electrical characteristic more commonly called Hertz, abbreviated as Hz. In America, we use 60 Hz AC power; most of the rest of the world uses 50 Hz AC power.

The **induction motor** is the most common AC motor used today. This type of motor converts cyclical reversals of electrical energy to rotational mechanical energy. The line frequency and the number of magnetic poles in the stator windings determine the base speed of the motor. If one set of windings (i.e., one pair of poles) is used in the stator, the magnetic field rotates 360-degrees during the AC cycle. (See *Figure 8.1*)

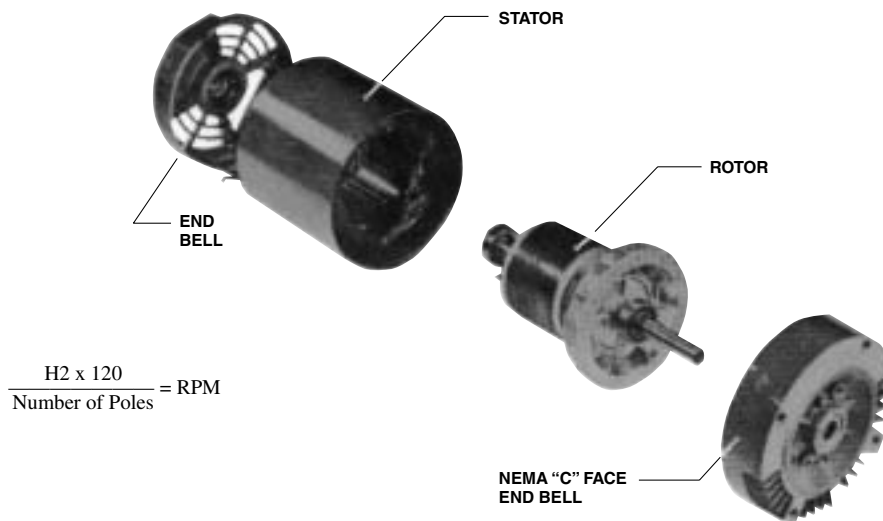

Figure 8.1, Exploded View, AC C-Face-Mounted Motor

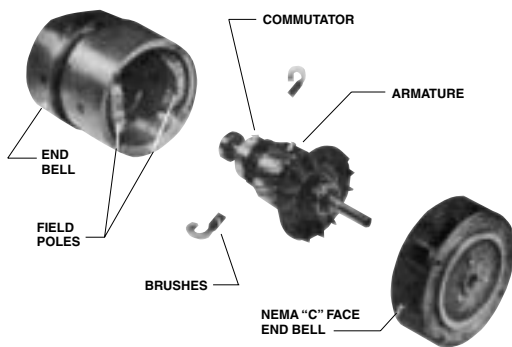

Figure 8.2, Exploded View of "Wound-Field" DC Motor

Example: At 60 Hz, a two-pole motor has a maximum speed of 60 revolutions per second, or 3600 RPM; four poles, 30 revolutions per second, or 1800 RPM; six poles, 20 revolutions per second, or 1200 RPM, etc. Thus, it is possible to vary or adjust the speed of an AC motor by varying the frequency applied.

For all intents and purposes, these "inverters" convert AC to DC and then "synthesize" a 3-phase output for the driven motor. These controllers are especially useful for using AC motors that are "special" and/or hard to replace, and when adjustable speed may be necessary. AC controllers provide speed ranges from zero to base speed (a subject that will be discussed later on in our Power Transmission 101 course).

DIRECT CURRENT (DC) MOTORS

Direct current travels in only one direction, like water through a pipe. It has no "frequency" since it does not reverse direction the way AC does. The DC motor is ideal for speed adjustments, since its speed can be simply and economically varied from base speed to zero RPM, by adjusting the voltage applied to the armature of the motor. Boston Gear's Ratiotrol DC systems employ this basic principle

In a DC motor, the rotating element is called the armature and the stationary component, the field. In an AC induction motor, power is applied to the field (stator) only. In a shunt-wound DC motor, both field and armature are energized. The armature windings are connected to commutator segments, which receive electrical power through carbon "brushes." (See Figure 8.2)



Figure 8.3, M-Series DC Motors

The application of DC power to the field of a DC motor creates a magnetic force that also passes through the armature. When DC power is applied to the armature, another magnetic field is set up which either opposes or assists the magnetic force of the field, depending on the polarity of the two fields. The commutator on the armature serves as a means of changing the direction of current flow in the conductors of the armature windings. This continuous repelling and attraction causes the armature to rotate at a speed determined by the voltage and current in the field and armature. *RATIOCONTROL* controllers change the speed of a DC shunt wound (See Figure 8.4) motor by varying the voltage supplied to the armature, while keeping the field voltage constant. In this way, the speed of a DC motor can be infinitely varied from base speed of the motor to zero RPM.

Permanent magnet (PM) (See Figure 8.5) DC motors have no field winding; they do not, therefore, require any power to energize the field. The field is a permanent magnet, which results in a motor that is the equivalent of a shunt-field motor with regard to performance, yet often smaller, lighter and less costly.

Ratiocontrol controllers can be used with either shunt-field or PM motors. PM motors are usually the better choice for the reasons mentioned above. In addition, the presence of only two wires to connect the armature leads minimizes the chance of installation errors that can result in smoking the motor, resulting in a costly problem.

APPLYING RATIOCONTROL

Several factors must be considered when selecting the best drive for an application, starting with the *type of load*.

- **Constant torque loads**, the most common type of load, require the same torque (or turning effort) at low speed as is required at high speed. Most applications fall into this category including conveyors, printing presses, agitators, etc. A constant torque drive delivers its rated torque regardless of RPM, but the horsepower varies directly with speed. For most applications, the torque requirements remain essentially constant over the speed range. Thus, the horsepower requirements decrease in direct proportion to the speed. Maximum (rated) horsepower is only acquired at maximum (base) speed. (See Figure 8.6)



Figure 8.4, Shunt Wound Motor



Figure 8.5, Permanent Magnet Motors

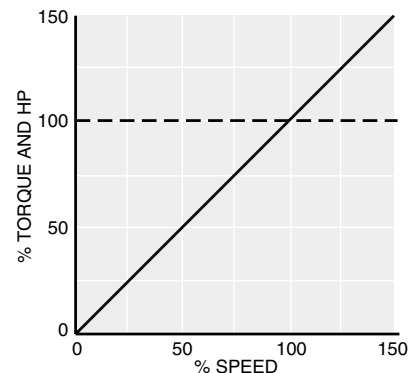

Figure 8.6, Constant Torque

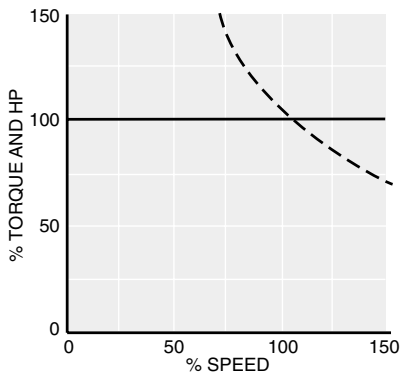

Figure 8.7, Constant Horsepower

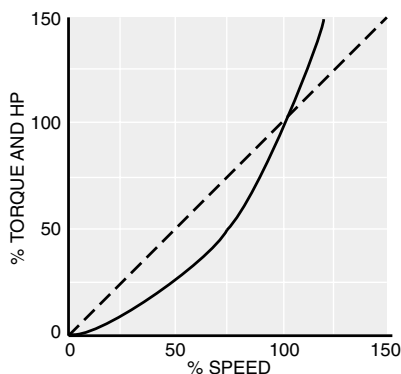

Figure 8.8, Squared Exponential Horsepower

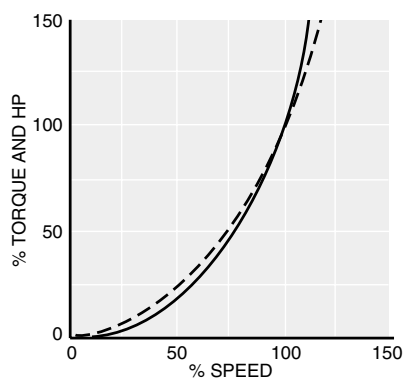

Figure 8.9, Cubed Exponential Horsepower

- Another type of load – the **constant horsepower application** – requires equal horsepower throughout its speed range. Examples of constant horsepower loads include center-driven winders and machine tools that are used to remove material. Winders or rewinds require that the product tension remain constant regardless of speed while the coil of paper, cloth, film, etc. builds up on the winder. In the case of the machine tool, heavier cuts are taken at lower speeds, necessitating more torque.

(See Figure 8.7)

- Variable torque and horsepower loads require less torque at low speeds than at higher speeds, and are used with fans, blowers and centrifugal pumps. (See Figures 8.8 and 8.9)

Approximately 90% of all general industrial machines (other than fans and pumps) are constant torque systems. Accordingly, the remainder of our speed drive lesson will be dedicated to that type of system.

RATIOTROL SELECTION

Before selecting a Boston Gear Ratiotrol motor speed controller system, it is extremely helpful to know the following:

HORSEPOWER (HP) OR TORQUE

Horsepower or torque must be known to properly size the controller and motor requirements for a given application.

POWER REQUIREMENTS

Depending on the series and size, Ratiotrol systems have been designed for use on single or polyphase power of various standard voltages. As a result, it is important to check control power requirements to assure that the proper power source is available; i.e., line voltage, frequency (Hz) and phase.

SPEED RANGE

Refers to the range of speed at rated regulation, as noted in the *Performance Characteristics* section of your Boston Gear Electrical catalog. For example, a 50:1 speed range means that a 1750-RPM motor can be adjusted anywhere between 1750 and 1/50th of 1750, or 35 RPM. Below that minimum speed the motor might stall if its load status should change from near no-load to full load. However, all Ratiotrol drives can operate from the motor's base speed to zero RPM.

SPEED REGULATION

As defined by NEMA, speed regulation is the change in motor RPM from *no load* to *full load* (or, more generally, to 95%-full load). Regulation is always expressed as a percentage of base speed. The value specified for each control series assumes that all other variables (such as line voltage, temperature, etc.) are constant and within specified limits.

Example: A control having a specified system regulation of 1%, used with a 1750 RPM motor, would experience a drop in speed of 17.5 RPM at any speed when experiencing a 95% load change.

DYNAMIC BRAKING (DB)

Many reversing applications require dynamic braking to permit the maximum number of reversals for the motor being used. Dynamic Braking permits faster than normal stopping, but it is not a holding brake: once the motor and load have stopped, there is no further braking action. Additional details regarding dynamic braking are included in the Options section of your Boston Gear Electrical catalog.

REVERSING

It is important to know whether the driven machine requires bi-directional operation or whether it always “travels” in the same direction. All Ratiotrol controllers offer reversing either as a standard or optional feature.

MANUAL SWITCHING

Manual Switching refers to a manual switch, usually a toggle type, which the operator must flip up or down, or side to side, in order to start, stop or reverse a drive.

MAGNETIC SWITCHING

Magnetic Switching refers to a contactor (or relay) mounted in a controller and operated by a pushbutton (or similar pilot device) outside the controller, usually in a remote station. Magnetic switching is easily adaptable to limit switches and remote stations designed for unusual conditions such as dust, water and hazardous atmospheres.

CATALOG

CHECK!:

While the basic terms and features discussed will help you select the right motor speed controller, your Boston Gear catalog contains additional details about special features, such as: adjustable linear acceleration, master override, multi-motor, multiple-preset speeds, adjustable torque control, tach follower, tach feedback and external signal follower options.



Figure 8.10

Selection: When selecting a Ratiotrol drive or a Ratiotrol/reducer system for constant torque, first determine:

- The maximum and minimum speeds required at the input shaft of the machine.
- The torque (in.-lbs.) required at the input shaft of the machine.

Note: If HP is given at maximum speed, it should be converted to torque using the following formula:

$$T \text{ (torque)} = \text{HP} \times 63,025 \div \text{RPM max.}$$

From the selection charts in your Boston Gear catalog, pick a drive with a torque capacity equal to or greater than that required for the application.

THE RATIOPAX SERIES

Ratiopax is the term Boston Gear uses for a simple, compact, non-modifiable enclosed DC motor speed controller used with motors ranging from 1/12 HP – 1 HP.

(See Figure 8.10)

The Ratiopax series provides a remote station-sized package offering fullwave rectification, transistorized SCR firing and IR-compensated armature feedback, combining economy and dependable performance.

The Ratiopax's clean, accessible printed circuit board solidly mounts all the components (except the front panel switch, speed-setting potentiometer and SCR's). The entire unit is housed in a rugged die-cast aluminum case measuring only 3" x 3" x 9".

Additional features include:

- Speed range: Infinitely adjustable from 0 to base speed
- Speed range at specified regulation: 20 to 1
- Regulation (no load to 95% load): 5% of base speed
- Full-wave armature rectification
- Transistorized firing circuitry
- Printed circuit construction
- Adjustable maximum speed
- Voltage feedback with IR compensation
- Automatic current limit

DCX & DCX PLUS SERIES

Ratiotrol DCX Controllers, developed as an OEM chassis system, also offer a full-featured controller in a physical package similar in size to the Ratiopax.

Enclosed, panel-mounted and open chassis versions of the DCX series – with ratings as high as 3 horsepower – offer a solution to almost any control application.

Additional features include:

- Speed range: to base speed
- Speed range at specified regulation: 30:1
- Regulation (no load to 95% load): 2%
- Full-wave power conversion
- Transient voltage protection
- DC tachometer feedback
- Automatic line voltage selection
- Adjustable current limit
- Adjustable maximum speed
- Adjustable minimum speed
- Adjustable IR compensation
- Adjustable acceleration/deceleration (with the exception of the DCX101C)
- NEMA 12 enclosed
- Ratings up to 3 horsepower. (See Figure 8.11)



Figure 8.11

BETA II AND BETA PLUS SERIES

The Beta series DC motor speed controllers represent the latest compact Ratiotrol SCR system. They are more rugged than the Ratiopax and DCX series and offer improved performance, expanded horsepower range and many other important operating and performance features.

The Beta series was designed to fill the void between the simple, economical DCX and Ratiopax and the more sophisticated VEplus and VED controllers.

In essence, Boston Gear Beta systems offer performance once available only in more sophisticated drives coupled with an economy and design simplicity approaching the Ratiopax. (See Figure 8.12)



Figure 8.12

ADDITIONAL BETA II FEATURES INCLUDE

- Horsepower range: 1/12 – 3 HP
- Speed range: Infinite
- Speed range at specified regulation: 50:1.
- Regulation (no load to 95% load): 2%.
- Full-wave rectification
- UL Listed
- CSA Approved
- TENV die-cast enclosure, gasketed
- “Washdown” models to meet NEMA 4X specifications
- NEMA 3, 4 or 12 enclosure
- Chassis and angle bracket mounting units
- User Adjustments:
 - Accel/decel time
 - Line-starting
 - Adjustable current-limit
 - DC tach feedback on unidirectional drives
 - 115/230 VAC – selectable

BETA PLUS ADDED FEATURES INCLUDED

- Horsepower range: 1/6 – 3 HP
- 4-SCR power bridge for improved motor performance and life
- Isolated regulator and feedback circuitry
- External 4-20 ma DC signal follower circuitry included
- Horsepower and AC line voltage calibration provided by jumper wires
- Bi-color LED indicator lamps signal normal operation as well as current-limit (overload) running conditions. (See Figure 8.13)



Figure 8.13

SELECTING YOUR RATIOTROL PRODUCT

Now let's apply what we have learned about Ratiotrol motor speed controllers by selecting a controller for a typical application. First, let's review the following givens:

- Application: horizontal conveyor
- Torque required at conveyor shaft: 235 in.-lbs
- Speeds required at driven shaft: 10 to 58 RPM
- Load type: constant torque (the torque remains the same throughout the speed range)
- Line Power: 115 VAC, single phase, 60 Hz
- Reversing required occasionally
- Ambient conditions: clean, dry, temperature 70-100-degrees F
- Drive type desired: right-angle gear motor

Step 1: Selection of the reducer/motor system. The customer's requirements regarding performance, operators devices and/or options will determine the best control series to recommend.

Step 2: With known requirements of 235 in.-lbs. at 58 RPM, use the following formula to **determine the estimated horsepower:**

$$\begin{aligned} & Tq \text{ (in.-lbs.)} \times \text{rpm} \div 63,025, \text{ or} \\ & 235 \times 58 \div 63,025 = 0.216\text{HP output} \end{aligned}$$

Step 3: Refer to the Reducer Selection Chart in the Worm Gear Drives catalog.

Step 4: Select a suitable Ratiotrol controller/motor combination using the Selection Chart from the Boston Gear Electrical Products catalog.

Important: Once you have selected the system HP and the motor required, the functional, mechanical and physical requirements of the application must be analyzed. At that point, the controller can be selected from the information included on the **RATIOTROL SYSTEMS** charts shown in the Boston Gear Electrical catalog.

Step 5: Depending on the customer's size, functionality, and other requirements, any one of the previously mentioned controllers could be selected.



Figure 8.14, VED Series Controllers

VED SERIES DC ADJUSTABLE SPEED CONTROLLERS

VED controllers are high performance, microprocessor-based, software-configured, packaged drive units that represent a significant advance in single-phase control design. They offer advantages formerly possible only with complex and expensive external digital control loops. Standard VED features include:

- Pre-tuned control algorithms for speed and current regulators
- Digital set-up and troubleshooting
- Complete self-diagnostic capabilities

Optional features – which make the VED series an ideal choice for a broad range of industrial applications – include:

- Remote interrogation
- Digital speed input and feedback
- Accurate digital speed regulation
- Serial communication for direct control by programmable logic controllers and computers

VED units include conversion of AC line power to DC for adjustable speed armature control of shunt-wound and permanent magnet field DC motors. (See Figure 8.14)

MODEL TYPES

VED units are offered in both open chassis and enclosed configuration in 26 standard models. The basic, open chassis models – VED100 (for 115V AC power) and VED300 (for 230 V AC power) – form the nucleus of all the other models. The other 24 are assembled from the two basic models using the appropriate option kits, which can be ordered factory-installed or easily added in the field.

LOCAL CONTROL OPERATION

Local control, enclosed, packaged models are provided with an integral cover-mounted operator control panel. Included are membrane push switches for all control functions and an LCD display that indicates important operational data.

REMOTE CONTROL OPERATION

Enclosed, packaged remote control models have a blank cover mounted in the space reserved for the operator control panel. Because the cover and operator control panels are dimensionally interchangeable, the controller may be easily field-converted from local to remote control.

VEplus SERIES ADJUSTABLE SPEED CONTROLLERS

The VEplus Series incorporates the latest technology in solid state design. The result: the most versatile, rugged DC motor speed controllers available today. Its many features make the VEplus controller precise, adaptable and rugged – ideal for even the fussiest application. Features include:

- VEplus controllers are available in 1/6 to 1 HP for 115VAC single phase 50/60 Hz and 1 to 5 HP for 230VAC single phase power.
- VEplus controllers can follow signals from other upstream drives, be commanded to change speeds automatically, start and stop on demand, reverse, start smoothly, and stop very quickly.
- Option combinations permit the systems to follow temperature changes, weight recorders, computer or PC commands.
- All controllers are CSA-approved, UL listed – increasingly important factors in today's marketplace.
- Speed Range: Indefinitely adjustable from zero to base speed.
- Speed Range: Full Load, Continuous Operation: 50 to 1.
- Regulation, 95% Load Change: 2% of motor base speed.
- Efficiency (Maximum Speed):
 - Controller, SCR Regulators – 99%
 - Complete drive with motor – 85%

(See Figure 8.15)

ADDITIONAL FEATURES:

- Full wave armature supply: 4-SCR 600 PIV power bridge, on all controllers.
- Armature voltage feedback and IR compensation for maximum speed stability and regulation.



Figure 8.15

- Modular construction: Four(4) printed circuit boards and encapsulated bridge.
- Plug-in input option boards.
- Plug-in feedback options.
- Transient voltage protection utilizing metal oxide varistors.
- Lightweight, heavy-duty, totally enclosed aluminum die cast housing, light gray epoxy finish, readily convertible to NEMA 3, 4 and 12.
- Circuit breaker provides instantaneous peak load tripping and short circuit protection (serves as AC on-off switch).
- Motor contactor: disconnects motor armature, incorporates "dry switching" for maximum life. Prevents automatic restart after power interruption. Provides under voltage protection.
- Load monitor circuit: electronically monitors motor armature current and stops drive if the load exceeds 120% for 80 seconds. Provides protection equivalent to a motor thermostat.
- Adjustments:
 - Speed 0-100% of motor base speed
 - Maximum speed: 60-100% of base speed
 - Minimum speed: 0-30% of base speed
 - Current limit: 50-150% full load torque
- UL listed
 - Low voltage pilot circuit: 24VDC
 - AC power disconnect: circuit breaker
 - Mandatory restart
 - Armature contactor

Now let's quickly review the general characteristics of Boston Gear's Ratiotrol systems, keeping in mind why you would suggest one rather than another for a particular application or customer.

- Ratiopax: non-modifiable.
- BETA II, BETAplus: limited modifications and options.
- VEplus, VED: many options, field installable.

OPTION KITS

Option kits are described briefly in Boston Gear's Electrical Products catalog. The most popular options are dynamic braking, reversing (manual as well as magnetic), open chassis construction, jogging, master override, adjustable linear acceleration, multiple preset speeds, torque-taper, tach follower, tach feedback, external signal follower and special enclosures.

Keypoints

- Boston Gear carries a wide range of single phase DC controls
- Ratiotrol controllers have a long history of quality and dependability
- Horsepower ranges grow 1/12 to 5 in. single phase
- Engineering staff at Boston Gear can help with any application problem
- All ratiotrol controllers carry a full 2 year warranty

Quiz

CLICK HERE or visit <http://www.bostgear.com/quiz> to take the quiz

QUIZ

CENTRIC OVERLOAD RELEASE CLUTCHES

10





In 1998, Boston Gear acquired the Centric Clutch Company. In 1948, Centric Clutch started manufacturing centrifugal clutches for a wide range of industries. These clutches were originally designed as a means to connect power in a drive train with soft start and delay capabilities. Centric's centrifugal clutch was the industry's first overload protection device with repeatable performance. The Boston Gear/Centric centrifugal clutch offers many advantages in electric motor and engine drive applications. Utilizing a centrifugal clutch enables the selection of normal torque motors for running loads rather than the selection of high torque motors for starting loads. The centrifugal clutch also sharply reduces the motor starting current requirements and heat losses inherent to the direct starting of a drive. This adds up to reduce power factors greater efficiency and therefore, greater economy in motor drives.

When used with engine drives, the spring controlled centrifugal clutch allows the engine to warm up before starting the load or to stand by at an idling speed. Thus the spring controlled centrifugal clutch is used to great advantage in such applications as dual drives and engine pumping systems. This style clutch also can be used with turbines where a warm up period is necessary.

On any drive, the Boston Gear Centric centrifugal clutch provides protection against the shock loads which occur in the starting of a rigidly coupled drive. In many cases, these loadings are capable of seriously damaging components of the drive. Often expensive safety factors have to be designed into the machinery to protect against these loadings. The use of a centrifugal clutch also has inherent overload protection. If for some reason the driven machinery develops an overload condition, the clutch capacity will be exceeded and the clutch will slip, protecting the driving machinery.

The use of a Boston Gear Centric centrifugal clutch allows the designer of a particular drive complete flexibility in clutch selection as each clutch is made, to order. Friction shoes of specific weights are custom designed, therefore, any capacity within a particular size can be obtained. The same holds true in the case of the spring controlled clutch. This style of clutch is designed to provide the specific engagement or disengagement speeds required by a specific application.

OPERATING PRINCIPLES

Boston Gear Centric centrifugal clutches utilize two basic force principles in their operation, centrifugal force and friction force. Centrifugal force is that force which tends to pull a rotating body away from the center of rotation. Friction force exists between any two bodies in contact where one of the bodies is trying to move relative to the other body.

Figure 1, a face view of a centrifugal clutch, shows the basic components of the device. The driver half or spider is mounted to the motor or engine shaft and the driven half is connected to the load either directly or by an indirect drive arrangement. The friction shoes are the connecting element between the driver and the drum.

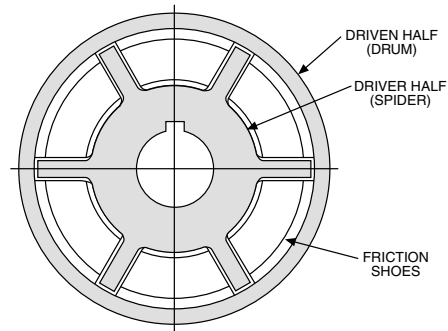

Figure 1

When the drive is set in motion, the spider and the shoes start to rotate. The spider imposes a driving force (F_3) on the friction shoes as shown in Figure 2. The centrifugal force (F_1) developed by the rotary motion of the friction shoe impresses it against the drum creating friction (F_2) between the shoe and the drum.

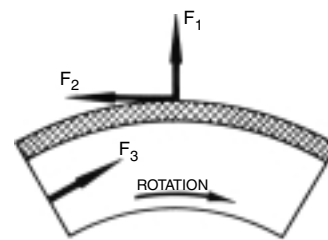

Figure 2

As the drive increases in speed, the centrifugal force increases and thus frictional force increases. When the frictional force reaches sufficient magnitude, it overcomes the resistance of the load, and the clutch drives. At full load speed, the shoe is "locked" firmly against the drum and no slippage occurs.

In engine and turbine applications, where it is necessary to "warm up" before attempting to drive a load, a spring controlled clutch is used. Figure 3 shows a typical spring controlled shoe. Here, a flat spring is placed over pins which run through the base of the shoe. This spring is retained in slots which are milled in the legs of the spider creating additional forces (F_s) which are applied to the friction shoes. The thickness of the spring utilized determines at what speed the particular drive may idle while warming up. At this idling speed, force (F_1) developed by the rotation is not of sufficient magnitude to overcome the total spring force ($2F_s$) acting in the opposite direction on the friction shoe. As the speed of the drive increases above the point at which the spring force (F_s) and the centrifugal force (F_1) are balanced, the shoe is pressed against the drum creating a friction force. The operation from this point on is as described above.

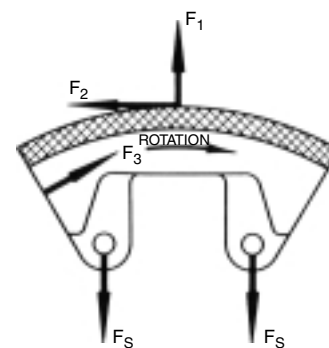

Figure 3



Figure 4

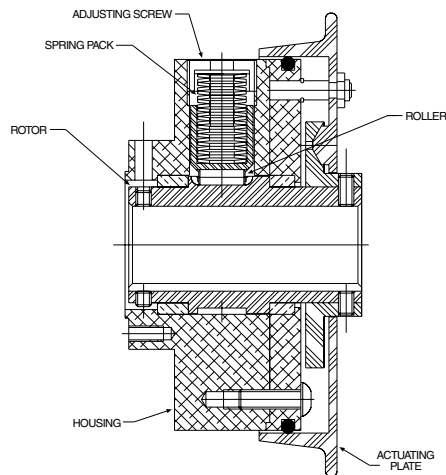

Figure 5

TRI-O-MATIC LITE OVERLOAD CLUTCHES LOR SERIES

FEATURES

- Simple cost-effective design
- Bi-directional operation
- Single position reset
- Reliable limit switch actuating plate
- Easy torque adjustment
- Accurate and repeatable torque settings of 10%
- Maximum torque limit stop
- Through shaft or end shaft mounting
- Straight bore bushings for mounting and stocking flexibility
- Split taper bore bushings for secure mounting
- Large bore capacity (See Figure 4)

OPERATING PRINCIPLES

The LOR Series Trig-O-Matic Lite is an automatic reset, roller detent style clutch. It was designed to be cost-effective without sacrifice to accurate and dependable disconnect protection for mechanical equipment. Refer to *Figure 5*.

Torque transmission between the roller and the rotor is the key to the disengagement of the clutch. The roller is forced into the detent of the rotor by a radial load generated by compressing a spring pack. This load determines the torque capacity of the clutch. Increasing or decreasing the spring compression provides an adjustment to the torque capacity. When a torque overload condition occurs, the roller moves out of the detent and free-wheels much like a needle bearing.

SELECTION

1. Determine overload release torque by one of these methods:
 - a. Use the torque formula with horsepower and RPM specific to the selected clutch location. A service factor may be required for high inertia starts, reversing or peak load conditions.

$$\text{Torque (Lb.In.)} = \frac{\text{HP} \times 63025}{\text{RPM}}$$
 - b. Determine the "weak link" in the drive train, (i.e. chain, reducer, belt or shaft). Select an overload release torque that is below the "weak link's" maximum torque rating.
 - c. Physically measure the drive torque with a torque wrench and size accordingly.
2. Determine the bore size, keyway, and taper bore or straight bore bushing model.
3. Refer to the Basic Selection Chart for the appropriate clutch size. (See Figure 6)
4. Refer to the Boston Gear Centric Catalog for ratings and dimensions.
5. Refer to the Boston Gear Centric Catalog for recommended mounting locations.

BASIC SELECTION CHART

Clutch Size	Max. Bore (In.)		Torque Range (Lb. In.)	Maximum RPM
	Straight	Taper		
060	1.4375	1.1250	200-700	1,000
200	2.1250	1.7500	600-2,000	1,000
400	2.7500	2.2500	2,000-5,000	600

*Larger bores may require reduced keys (supplied with unit)

Figure 6

TORQUE ADJUSTMENT

Each clutch is tested throughout the torque range then set at the minimum torque range value at the factory. The torque dial label is indexed to a match mark on the clutch at the number "1" location. The torque dial label has eight hash marks evenly spaced at 45 degrees. To increase the torque, loosen the locking screw and turn the adjusting screw lockwise. When the desired torque value is achieved, secure the torque adjustment screw by tightening the locking screw. (See Figure 7)

TORQUE ADJUSTMENT

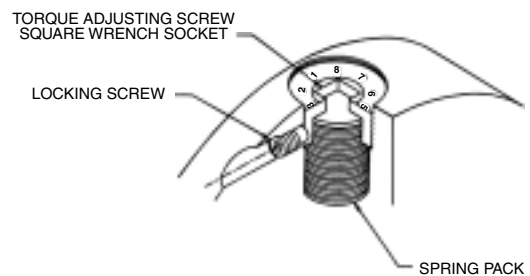

Figure 7

COMMON**APPLICATIONS:**

packaging machinery, paper converting machinery, baking equipment, bottling and capping machinery, indexing machinery, labeling machinery, conveyors, presses and water treatment equipment.

TRI-O-MATIC LITE OVERLOAD CLUTCHES ORC SERIES

FEATURES

- Bi-directional operation
- Single positioning for re-engagement at the exact cycle point at which it released
- Adjustable torque setting with accuracy of 10%
- Limit switch actuation for remote detection of overload condition
- Completely enclosed for dirty applications
- Automatic or manual reset
- Various configurations for direct and indirect drives
- Six sizes (Model F – five sizes) to accommodate various bore and torque ranges

The Trig-O-Matic's unique "Trigger" action design disconnects the load at the instant an overload occurs and at the exact torque limit you set. When the overload condition is corrected, the clutch resets at the exact cycle point and torque at which it released.

The ORC Series Trig-O-Matic Overload Clutch is available in two models: the Standard Model S and the Fully Automatic Model F. (See *Figure 8*) Both provide single position engagement and a means to signal an overload condition.

APPLICATIONS

The ORC Series Trig-O-Matic Overload Release Clutch can be applied on any drive train where the protection of reducers, indexers, chain, sprockets or product is required.

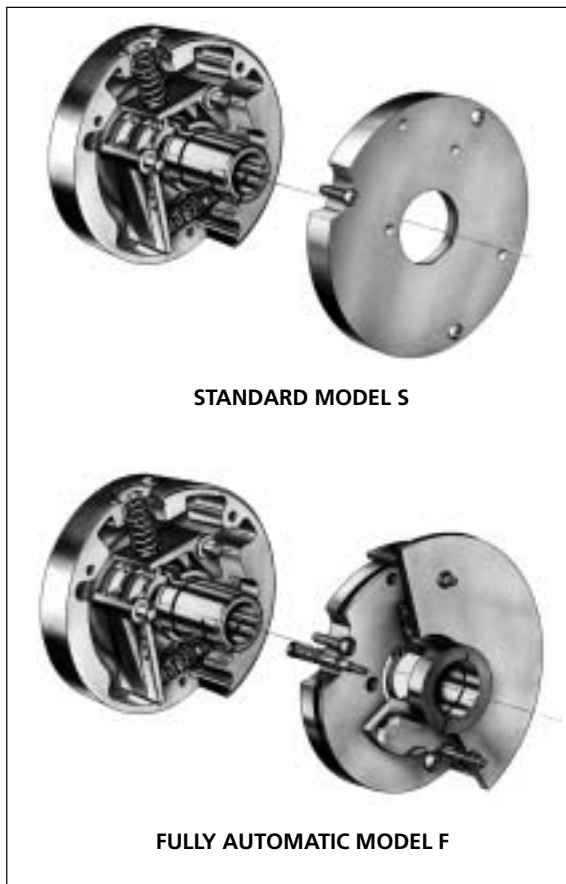

STANDARD MODEL S

FULLY AUTOMATIC MODEL F

Figure 8

SELECTION

The **Standard Model S** is Boston Gear's basic low-cost unit on which various optional features can be added. The clutch mechanism is available in automatic or manual reset. Typically, a manual reset clutch is used where it will run disengaged for extended periods of time. The automatic reset is generally used in conjunction with a limit switch to shut the drive down. The Standard Model is typically used to replace shear pins and where access to the clutch is available.

The **Fully Automatic Model F** includes all the features available in the Standard Model plus an automatic switch actuating mechanism, an automatic clutch mechanism and three mounting styles. The Model F is generally used where the unit is not easily accessible. This model is a complete overload clutch designed especially for production and packaging machinery.

See how these popular models compare in *Figure 9*.

TRIG-O-MATIC ORC SERIES STANDARD MODEL S

OPERATING PRINCIPLES

The standard Model S ORC Series Trig-O-Matic Overload Release Clutch consists of two basic components: the rotor and the housing assembly. The clutch rotor is keyed and secured with a setscrew.

The housing assembly includes a drive pawl and a reset pawl, which are pivoted within the clutch housing. The drive pawl is held engaged in the rotor notch by the combined pressure of the drive and reset springs as shown in *Figure 10*. The combined pressure of these two springs determines the maximum torque that is transmitted without overload. With the clutch mechanism in the engaged position shown in *Figure 10*, the rotor and housing are held together and the entire unit rotates with the drive shaft at the same speed.

TRIG-O-MATIC MODEL FEATURE COMPARISONS

ORC Series Model S	ORC Series Model F
Bi-directional	Bi-directional
Single Position	Single Position
Manual Clutch Reset	Automatic Clutch Reset
Automatic Clutch Reset	Automatic Clutch Reset
Clutch Types B, C, N, R, T	Clutch Types B, C, N, R, T
One Mounting Style	Three Mounting Styles
Limit Switch Pin	Fully Automatic
Limit Switch Plate Actuator	Limit Switch Plate Actuator
Additional Features: Torque Selector Dial Max. Torque Limit Stop Grease Pack & Relief Fittings	Additional Features: Torque Selector Dial Max. Torque Limit Stop Grease Pack & Relief Fittings Locking Collar Mounting
Optional: Pressure Lube Bearings Balancing Locking Collar Mounting	Optional: Balancing One-Directional Feature

Figure 9

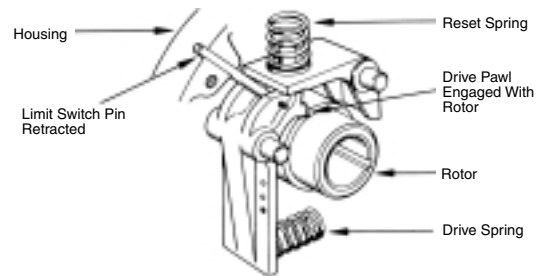

The Standard Model Trig-O-Matic is available in two clutch reset types: Manual and Automatic.

Figure 10, Model S Engaged

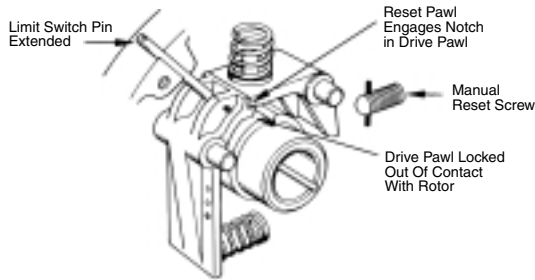

Figure 11, Disengaged - Manual

MANUAL RESET

The instant an overload occurs, the pressure of the drive and reset springs is overcome by the extra force applied to them. The drive pawl is forced out of its engaged position from the rotor and as it pivots up, the reset pawl lifts and locks it out of contact with the rotor as shown in *Figure 11*. The clutch then rotates freely.

When the overload condition has been corrected, the clutch is reset by inserting a hexagon wrench in the reset screw and turning the screw clockwise until the reset pawl releases the drive pawl. When the drive pawl re-engages with the rotor, the reset screw must be backed out to its original stop position. This is essential to restore the torque to its original setting.

AUTOMATIC RESET

The instant an overload occurs, the pressure of the drive and reset springs is overcome by the extra force applied to them. The drive pawl is forced out of its engaged position from the rotor. The reset pawl applied pressure to the top of the drive pawl, holding it in contact with the rotor as shown in *Figure 12*. After one revolution the drive pawl will automatically return to its engaged position.

The drive should be stopped as soon as possible. After the overload condition has been corrected the drive must be "jogged" until the drive pawl engages with the rotor.

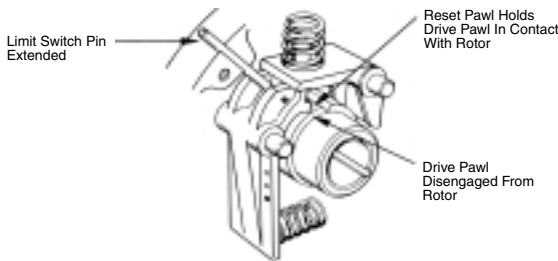

Figure 12, Disengaged - Automatic

LIMIT SWITCH PIN

A limit switch pin is furnished as a standard item to activate a limit switch that triggers the electrical controls. The travel of the limit switch pin protruding radially from the clutch housing is controlled by the drive pawl motion upon disengagement. The limit switch pin can be used if the housing continues to turn when an overload occurs and the rotor stops, (i.e., the housing is the driver and the rotor is the driven). The housing RPM must be considered to determine the time for the limit switch pin to revolve around before contacting the limit switch.

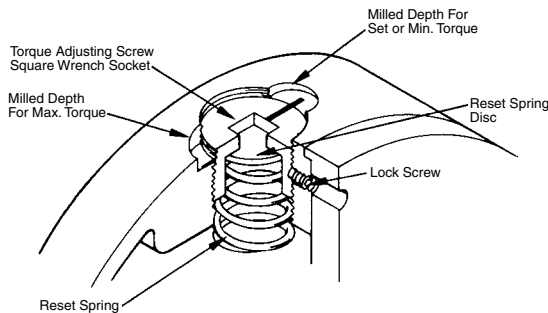

Figure 13

TORQUE SELECTOR DIAL

The torque selector dial shown in *Figure 13* is a standard feature on all Standard Model S Trig-O-Matic clutches. Each clutch is individually calibrated to specific torque values. The housing has two milled marks indicating minimum and maximum torque.

H1600 OVERLOAD CLUTCHES HOR SERIES

FEATURES

- Bi-direction operation
- Single position indexing
- Automatic reset
- Accurate and dependable disconnection, 10% of torque setting
- Convenient torque adjustment
- Maximum torque limit stop
- Limit switch actuating mechanism
- Clamp collar for secure mounting
- Hardened components for long life
- Electroless nickel finish and stainless steel hardware for superior corrosion resistance (See Figure 14)



Figure 14

OPERATING PRINCIPLES

The HOR Series H1600 is an automatic reset ball detent style overload release clutch. It has been designed to provide accurate and dependable torque disconnect protection for mechanical power transmission equipment. Torque is transmitted through the clutch in one of two paths. Refer to Figure 15.

Torque transmission between the balls and housing is the key to the disengagement of the clutch. The balls are forced into the pockets of the housing by an axial load generated by a compressing spring pack. The axial load determines the torque capacity of the clutch. Increasing or decreasing the spring compression or changing spring packs provides a means for multiple torque adjustments. When a torque overload condition occurs, the balls roll out of the pockets and freewheel much as a ball thrust bearing.

The movement of the cover during disengagement can be used to trip a limit switch and signal a torque overload condition.

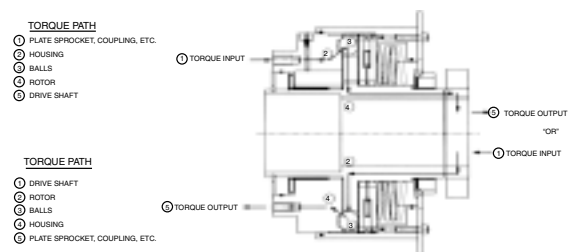

Figure 15



Figure 16

H1900 OVERLOAD CLUTCHES FOR THE WASTE-WATER TREATMENT INDUSTRY WOR SERIES

FEATURES

- Automatic or manual reset
- Large bore capacity
- Through shaft or end shaft mounting
- Accurate torque release
- Stainless steel enclosure
- Electroless nickel plated
- Adaptable for all drives
- Operating parts are hardened for long life (See Figure 16)

OPERATING PRINCIPLES

The WOR Series H1900 is a mechanical ball detent overload release clutch. It has been designed to provide accurate and dependable torque overload protection for mechanical water and wastewater treatment equipment.

Torque is transmitted between the balls and the detents of the rotor in the following manner:

The chrome alloy balls are forced into the detents of the 50 Rc hardened rotor by an axial load generated by compressing a spring pack. This axial load is what determines the torque capacity of the clutch. Increasing or decreasing the spring compression or changing spring packs provides a means for multiple torque adjustments. When a torque overload condition occurs, the balls roll out of the rotor detents. This rolling action reduces any fluctuation in torque due to frictional changes (See Figure 17).

The movement of the cover during disengagement of the balls can be used to trip a limit switch and signal an overload condition.

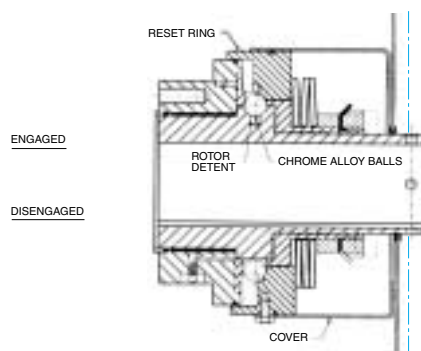

Figure 17

WATER AND WASTEWATER TREATMENT APPLICATIONS

Overload release clutches can be installed to provide positive protection against damaging jams to the drives. They are located on the output sides of speed reducers, or as near as possible to the potential source of the overload so that the drive components are adequately protected.

The completely sealed clutches are suitable for outdoor installations, including a stainless steel cover, electroless nickel plated external parts, and an external grease fitting for packing the units.

H2000 PNEUMATIC OVERLOAD CLUTCHES POR SERIES

FEATURES

- "In-Flight" torque control offers precise pneumatic torque control
- Remotely adjustable for starting and overrunning loads
- Bi-directional operation
- Single position indexing
- Automatic reset
- Accurate and dependable disconnection, 10% of torque setting
- Through-shaft design
- Limit switch actuating mechanism
- Clamp collar for secure mounting
- Hardened parts for long clutch life
- Internal needle roller thrust bearings
- Lubrication fittings
- Sealed from environmental contamination
- Electroless nickel finish and stainless steel hardware for superior corrosion resistance (See Figure 18)



Figure 18

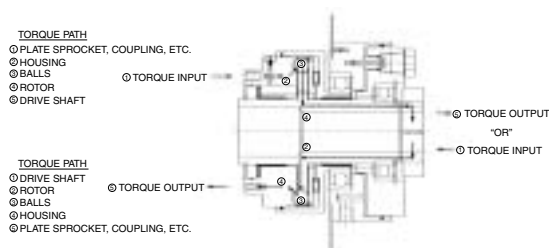

Figure 19



Figure 20

OPERATING PRINCIPLES

The POR Series H2000 is a pneumatic, ball detent style overload release clutch. It has been designed to provide accurate and dependable torque disconnect protection for mechanical power transmission equipment. Torque is transmitted through the clutch in one of two paths. (Refer to Figure 19).

Torque transmission between the balls and housing is the key to the disengagement of the clutch. The balls are forced into the pockets of the housing by an axial load generated by an air cylinder. Increasing or decreasing the air pressure provides a means for remotely controlled precise "in-flight" torque adjustment. When a torque overload condition occurs, the balls roll out of the pockets and free wheel much as a ball thrust bearing.

The clutch has been designed with an internal valving mechanism. During an overload condition, the air is purged instantaneously from the cylinder.

The movement of the air cylinder during disengagement can be used to trip a limit switch and signal a torque overload condition. To engage the clutch, reapply air pressure and job the drive until the clutch engages. Adjust the release torque by increasing the air pressure supplied to the clutch to reach the desired torque value. The clutch is now ready for normal operation.

PNEUMATIC CONTROL

Boston Gear offers a pneumatic control for use with POR Series H2000® overload release clutches. (See Figure 20)

This control allows you to regulate the system efficiently with dual air pressures. During start-up, the clutch may be required to transmit a higher torque due to the high starting inertia of the drive. Higher air pressure can be used to transmit this torque without prematurely disengaging the clutch. Once the drive has reached its operating speed, a lower operating torque may be seen by the clutch. Lower air pressure can be used to reduce the overload release point of the clutch to safely operate the drive at running speeds.

VARITORQUE PNEUMATIC OVERLOAD CLUTCHES VOR SERIES

FEATURES

- "In-Flight" torque control. Precise torque control adjustable for starting and overrunning loads
- Single positioning for re-engagement at the exact cycle point at which it released
- Torque accuracy within 5%
- Bi-directional operation
- Electroless nickel finish
- Six point drive engagement
- Automatic disconnect
- Deublin flange mounted air union
- Automatic switch actuating plate for instantaneous remote detection of overload condition
- Completely enclosed for "dirty" applications
- Pressure lubrication
- Positive split locking collar for secure shaft mounting
- Operates on static air pressure (20-80 psi), no elaborate air systems required (*See Figure 21*)

OPERATING PRINCIPLES – AIR UNION

The air pressure supplied to the clutch enters through the hex steel rotor of the Deublin air union. When the VOR Series VariTorque is engaged and operating, the union rotor is the only stationary part. The union housing rotates on a double row ball bearing protected by dirt-tight seals. A spring-loaded carbon micro-lapped seal prevents air leakage between the rotor and housing of the union. The air passes through the union housing into the cylinder assembly of the VariTorque.



Figure 21

AIR PRESSURE AND TORQUE CAPACITY

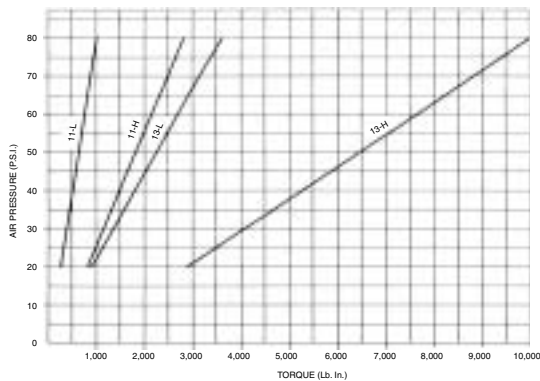

Figure 22

CYLINDER ASSEMBLY

Air pressure acts against the surface area of the piston exerting a force to move the piston against the pressure pins. Resulting torque ranges (see *Figure 22*) are developed by different size piston surface areas of the two cylinder sizes, (L-small, H-large).

GENERAL INFORMATION – AIR CONTROLS

The high pressure regulator should be set at a pressure just high enough to permit the VariTorque clutch to overcome any **momentary overload torques** caused during the machine's start-up and stopping period.

The low pressure regulator should be at a pressure just low enough to permit the VariTorque clutch to overcome the **normal operating torques** caused during the machine's running period and to permit a crisp and positive re-engagement of the VariTorque clutch should an overload occur.

CENTRIC CLUTCHES

CENTRIC CLUTCHES

SELECTION GUIDE

To select or order a Boston Gear Centric Clutch, please complete the following information and fax this form to Product Support at 1-800-752-4327.

GENERAL INFORMATION

Company		
Address	City	State
Contact Person	Tel. No.	Fax No.

APPLICATION DATA

1. Drive method: Electric Motor Engine/Turbine Other

2. Method of drive: Direct Indirect (provide sketch)

3. Power transmission requirements at clutch location:
 Horsepower _____ RPM _____

4. Type: Standard (A) Vertical Lift-Out (V)

5. Used as Overload Protection Device: Yes No

6. Speeds (required for engines, turbines, dual drives):
 Idling _____ RPM Engagement _____ RPM Disengagement _____ RPM

7. Bores: Driver (input) _____ inches Driver (output) _____ inches

8. Service Factor Required: _____

Use the space below to sketch any relevant application data:

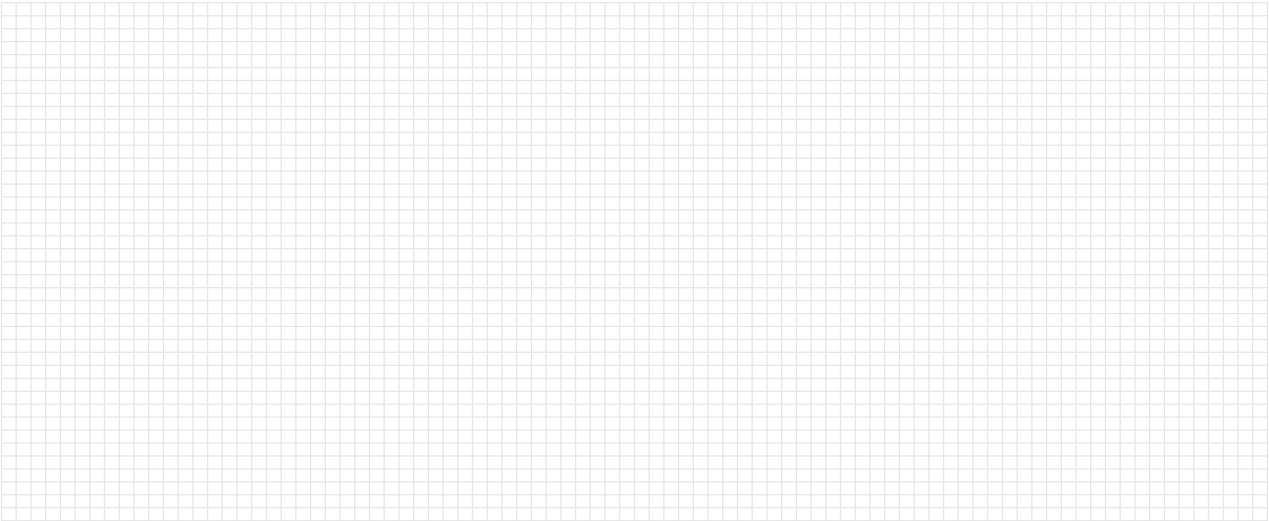

Quiz

CLICK HERE or visit <http://www.bostongear.com/quiz> to take the quiz